

HARCOAG PERSONNEL LIST

EQUIPMENT

<i>On-Line Catalogue</i>	Business	Cellular
SALES MANAGER Jake (John) Harkness – jakeh@harcoag.ca	519-338-2923	519-323-6119
GENERAL MANAGER Jorja Harkness – jorjah@harcoag.ca	519-338-2923	
TRANSPORT MANAGER & SALES Wes Hope – wesh@harcoag.ca	519-338-2923	519-323-1416
TERRITORY SALES MANAGER Shannon Little – shannonl@harcoag.ca	519-338-2923	519-323-7614
PARTS Aaron Schaefer - parts@harcoag.ca	519-338-2923	519-321-1173

HARCO AG CONTACT INFORMATION

5808 Highway 9, R.R. #4, Harriston, Ontario, N0G 1Z0

Office: 519-338-2923 • Fax: 519-338-2756

Watts: 1-800-461-0547 • Watts Fax: 1-800-650-1567

sales@harcoag.ca • www.harcoag.ca

AG SHIELD
SOLUTIONS FROM SEED TO HARVEST



Automatic

Big Jim
MANUFACTURING

BLU-JET
by Unserferth

DelMorino
FARM & GARDEN EQUIPMENT



FERRI

Halverson
HWP
Wood Products, Inc.

HCC
Complex Fabrication & Assembly

Highline



Mapleside
MFG INC



NIKKEL
Iron Works Corp.
1-800-342-9222



PALADIN



SCHMEISER



Teagle

WEAVERLINE

MASTER INDEX - HARCO CATALOGUE 2025

VISIT OUR WEBSITE FOR CURRENT PRICE PAGES & SALES PROGRAMS – www.harcoag.ca

PRODUCT	MANUFACTURER	SECTION/TAB	PAGE #	ON	PQ	MAR
Aerators	T.G. Schmeiser	1	27	*	*	*
Aerators-Rolling Harrow	T.G. Schmeiser	1	25-26	*	*	*
Applicators, Liquid-Fertilizer	Big Jim	Big Jim Tab	17-18	*	*	*
	Blu-Jet (Unverferth)	<i>Contact HARCO T.M. or Office</i>				
Augers		<i>Contact HARCO T.M. or Office</i>				
Back Filler-Trench/TrackMaster	Blu-Jet (Unverferth)	<i>Contact HARCO T.M. or Office</i>				
Bag Filler (Buckets)	ProDig	ProDig Tab		*	*	*
Bagger, Mulch	Weaverline	4	56	*	*	*
Bale Shredders	Teagle	4	31-52	*		
Bale Spears	Big Jim	Big Jim Tab	21	*	*	*
Bale Stackers	ProDig	ProDig Tab		*	*	*
Bale Wagons	John B.M. Martin	4	11-19		*	*
Bale Wrappers	Halverson	3	20	*	*	*
Balers	Sitrex	3	48-48L	*	*	*
Bedding Choppers	Weaverline	4	55-56	*	*	*
Blades – 3PT	Ideal	Ideal Tab	1-5	*	*	*
Boom Mowers	Ferri	3	55	*	*	*
Box Scrapers	Ideal	Ideal Tab	1-5	*	*	*
Buckets	ProDig	ProDig Tab		*	*	*
Canopy's – Mowers/Tractors	Cool Tops	5	10-11	*	*	*
Carts – Silage	Weaverline	4	57	*	*	*
Cement Mixers	Teagle	4	31-52	*		
Chain Harrows	May-Bridge	1	30-30B		*	*
Compactors//Rollers	Big Jim	Big Jim Tab	10-12	*	*	*
Coulters	Blu-Jet (Unverferth)	<i>Contact HARCO T.M. or Office</i>				
Cutters – Rotary	Del Morino	1	48-50	*	*	*
	Ideal	Ideal Tab	1-5	*	*	*
Discs (Offset-Tandem) Harrows	Athens	1	54-74	*	*	*
	Ideal	Ideal Tab	1-4	*	*	*
	T.G. Schmeiser	1	27	*	*	*
Drum Rollers, Lawn	Big Jim	Big Jim Tab	10-12	*	*	*
	Del Morino	1	50	*	*	*
Dump Trailers	John B.M. Martin	4	11-19		*	*
Earth Moving – TerraFormer	Ag Shield	5	5	*	*	*
Feeder//Bedders	Teagle	4	31-52	*		
Feeder Wagons	John B.M. Martin	4	11-19		*	*
Fertilizer Injector	Blu-Jet (Unverferth)	<i>Contact HARCO T.M. or Office</i>				
Fertilizer Spreader – 3PT/Pull Type	Sitrex	2	9	*	*	*
	Ideal	Ideal Tab	1-5	*	*	*
Finishing Mowers	Ideal	Ideal Tab	1-5	*	*	*
Flail Mowers	Del Morino	3	70-75	*	*	*
	Ferri	3	55	*	*	*
Forestry Winch	Big Jim	Big Jim Tab	16	*	*	*
Forks-Grass, Manure, Pallet, Stone	ProDig	ProDig Tab		*	*	*
Forks, Pallet						
Grabs; Shear, Tine, Hydraulic	ProDig	ProDig Tab		*	*	*
Grapple – Log, Brush, etc.	Big Jim	Big Jim Tab	20	*	*	*
	Ideal	Ideal Tab	1-5	*	*	*

MASTER INDEX - HARCO CATALOGUE 2025

VISIT OUR WEBSITE FOR CURRENT PRICE PAGES & SALES PROGRAMS – www.harcoag.ca

PRODUCT	MANUFACTURER	SECTION/TAB	PAGE #	ON	PQ	MAR
Grass Forks	ProDig	ProDig Tab		*	*	*
Harrowes	May-Bridge	1	30-30B		*	*
Hay Rakes & Tedders	Nikkel-DARF	3	50-52	*	*	*
	Sitrex	3	46-47a	*	*	*
Hay Conditioner	Ag Shield-Recon	3	35	*	*	*
Landscape Rakes	Ideal	Ideal Tab	1-5	*	*	*
Lawn Rollers	Big Jim	Big Jim Tab	10	*	*	*
	Del Morino	1	50	*	*	*
	Ideal	Ideal Tab	1-5	*	*	*
Liquid Applicator	Big Jim	Big Jim Tab	17	*	*	*
	Blu-Jet (Unverferth)	<i>Contact HARCO T.M. or Office</i>				
Manure Spreaders	Teagle	4	31-52	*		
Mowers – Flail	Del Morino	3	70-75	*	*	*
	Ferri	3	55	*	*	*
Mowers – Rotary	Ideal	Ideal Tab	1-5	*	*	*
Mowers – Sickle	Sitrex	3	44	*	*	*
Mowers – Offset, Pull Behind	Del Morino	3	70-75	*	*	*
	Ferri	3	55	*	*	*
Mowers – Slope	Del Morino	3	70-75	*	*	*
Packers, Pulverizers	Big Jim	Big Jim Tab	1-9	*	*	*
	Weaverline	3	5	*	*	*
Pallet Forks	Ideal	Ideal Tab	1-5	*	*	*
Poly Wear Products	PolyTech	5	35	*	*	*
Post Driver	Big Jim	Big Jim Tab	14-15	*	*	*
	Ideal	Ideal Tab	5			
Primary Tillage	Blu-Jet (Unverferth)	<i>Contact HARCO T.M. or Office</i>				
	Big Jim	Big Jim Tab	19	*	*	*
	T.G. Schmeiser (Smart-Till)	1	25-26	*	*	*
	T.G. Schmeiser	1	27	*	*	*
Pro Sweep	Athens	1	<i>Contact HARCO T.M. or Office</i>			
	ProDig	ProDig Tab		*	*	*
Rakes – Hay	Sitrex	3	46-47a	*	*	*
Rakes – Landscape	Nikkel – DARF	3	50-52	*	*	*
Rollers, Field (Drum), Landscape	Ag Shield	1	19-23	*	*	*
	Big Jim	Big Jim Tab	10-12	*	*	*
	Del Morino	1	50	*	*	*
Rollers, Municipal Park	Big Jim	Big Jim Tab	13	*	*	*
Rolling Harrow Aerator	T.G. Schmeiser (Smart-Till)	1	25-26	*	*	*
	T.G. Schmeiser	1	27	*	*	*
Rotary Cutters	Ideal	Ideal Tab	1-5	*	*	*
Rotary Tillers	Del Morino	1	48-50	*	*	*
	Ideal	Ideal Tab	1-5	*	*	*
Round Bale Wagons	John B.M. Martin	4	11-19		*	*
Secondary Tillage	T.G. Schmeiser (Smart-Till)	1	25-26	*	*	*

MASTER INDEX - HARCO CATALOGUE 2025

VISIT OUR WEBSITE FOR CURRENT PRICE PAGES & SALES PROGRAMS – www.harcoag.ca

PRODUCT	MANUFACTURER	SECTION/TAB	PAGE #	ON	PQ	MAR
Sickle Mowers	Sitrex	3	44	*	*	*
Silage Carts	Weaverline	4	57	*	*	*
Silage Packer	Weaverline	3	5	*	*	*
Slope Mowers	Del Morino	3	70-75	*	*	*
Slope Mowers	Ferri	3	55	*	*	*
SMV Signs	Toby's Mfg.	5	30	*	*	*
Snow Pushers	Ideal	Ideal Tab	1-5	*	*	*
Spike Aerator/Rolling Harrows	T.G. Schmeiser (Smart-Till)	1	25-26	*	*	*
	T.G. Schmeiser	1	27	*	*	*
Sprayers-ATV, Side by Side, Truck, 3pt.	Ag Shield	3	39-41	*	*	*
Sub-Tillers	Blu-Jet (Unverferth)	Contact HARCO T.M. or Office				
Sweepers (Sweepsters)	Paladin	Contact HARCO T.M. or Office				
Sweepers	ProDig	ProDig Tab		*	*	*
Tedders	Sitrex	3	46-47a	*	*	*
Tillage	Blu-Jet (Unverferth)	Contact HARCO T.M. or Office				
	Big Jim	Big Jim Tab	19	*	*	*
	T.G. Schmeiser (Smart-Till)	1	25-26	*	*	*
	T.G. Schmeiser	1	27	*	*	*
Tillers – Rotary	Ideal	Ideal Tab	1-5	*	*	*
	Del Morino	1	48-50	*	*	*
Top Soil Screener	Big Jim	Big Jim Tab	25	*	*	*
Trailers (Multi)-Hay Hauling	Ag Shield	3	42	*	*	*
TrenchMaster	Blu-Jet (Unverferth)	Contact HARCO T.M. or Office				
Tub Grinders	Roto-Grind	4	25	*	*	*
	Teagle	4	31-52	*		
Vertical Tillage	T.G. Schmeiser (Smart-Till)	1	25-26	*	*	*
Wagons	John B.M. Martin	4	11-19		*	*
Wheel Rakes	Sitrex	3	46-47a	*	*	*
Winch – Timber	Big Jim	Big Jim Tab	16	*	*	*
Wood Processors	Halverson	5	14-16	*	*	*
Wrappers (Bale)	Sitrex	3	48-48L	*	*	*
	Halverson	3	20	*	*	*

**Please Note: On Rep'd products dealers will be using company prices which may be in U.S. Funds. Funds may also be FOB factory prices. HARCO discounts and programs do not apply.*

For current up to date pricing, please visit our website – www.harcoag.ca

Contact HARCO Head Office or your TM for login information to access our most CURRENT PRICE PAGES & SALES PROGRAMS.



5808 Hwy #9, Harriston, Ont., N0G 1Z0

519-338-2923, Fax: 519-338-2756

Email: sales@harcoag.ca

www.harcoag.ca

Revised: May 10, 2025

**BIG JIM
TAB**



WHEEL PACKERS

Manufactured in-house at Harco Ag Equipment, Big Jim Packers are designed to give you greater durability and feature adjustable frames up to 15' models to permit exact matching of packer width to customer requirements. Our "DUCTILE WHEELS" are a top quality, thicker, heavier wheel which is a major improvement in reducing wheel breakage. For wider models, please inquire.

Standard Equipment:

High Quality Ductile Wheels, centre bearing 9 feet and up, adjustable frame 9-15 feet, 3-year limited warranty on ductile packer wheels.

Single Gang Specifications (9-15 feet):

Tubular frame construction 3/16" wall tongue and centre tube, 1/4" wall extension tubes, nine-foot tongue length, 1/2" x 6" bearing hangers, bearing mounted in hanger for rock protection, the bearing has a wide inner ring for more shaft contact, eccentric locking collar and duplex seal consisting of an oil-proof synthetic rubber seal and a steel slinger, greaseable flange, heavy duty ductile iron wheel retaining collar designed by HARCO, Grade 5 hardware, rear draw hitch.

BIG JIM's exclusive telescopic frame allows dealers to tailor packer width in-house.

Colour Options: Red, Green & Blue, Orange

16 Foot Single Gang Packer Specifications:

4" x 4" x 1/4" wall tubular construction, 11-foot tongue length, 1/2" x 6" bearing hangers, flat bar reinforced, bearings mount inside for rock protection, 2 centre bearing hangers, rear draw hitch.



15" – 33 lbs / Set

18" – 50 lbs / Set

Single Gang Packer with 15" Ductile Iron Smooth/Sprocket Wheel Combination

Model	Coverage	Description	Weight (lbs)	Price
BJ303	3'	Sprocket Packer Pup	543	\$2,426.00
BJ304	4'	Sprocket Packer Pup	675	\$2,808.00
BJ305	5'	Sprocket Packer Pup	794	\$3,187.00
BJ306	6'	Sprocket Packer Pup	920	\$3,568.00
BJ309C	9'	Sprocket Packer – Extendable Frame	1,316	\$5,788.00
BJ3010C	10'	Sprocket Packer – Extendable Frame	1,477	\$6,243.00
BJ3011C	11'	Sprocket Packer – Extendable Frame	1,560	\$6,729.00
BJ3012C	12'	Sprocket Packer – Extendable Frame	1,720	\$7,197.00
BJ3013C	13'	Sprocket Packer – Extendable Frame	1,799	\$7,667.00
BJ3014C	14'	Sprocket Packer – Extendable Frame	1,878	\$8,134.00
BJ3015C	15'	Sprocket Packer – Extendable Frame	2,003	\$8,609.00
BJ3016	16'	Sprocket Packer – Solid Frame	2,120	\$9,613.00

Single Gang Packer with 18" Ductile Iron Smooth/Sprocket Wheel Combination

Model	Coverage	Description	Weight (lbs)	Price
BJ318	3'	Sprocket Packer Pup	778	\$2,974.00
BJ418	4'	Sprocket Packer Pup	969	\$3,415.00
BJ518	5'	Sprocket Packer Pup	1,163	\$3,860.00
BJ618	6'	Sprocket Packer Pup	1,328	\$4,295.00
BJ918C	9'	Sprocket Packer – Extendable Frame	1,872	\$6,685.00
BJ1018C	10'	Sprocket Packer – Extendable Frame	2,214	\$7,202.00
BJ1118C	11'	Sprocket Packer – Extendable Frame	2,371	\$7,722.00
BJ1218C	12'	Sprocket Packer – Extendable Frame	2,604	\$8,240.00
BJ1318C	13'	Sprocket Packer – Extendable Frame	2,757	\$8,761.00
BJ1418C	14'	Sprocket Packer – Extendable Frame	2,910	\$9,279.00
BJ1518C	15'	Sprocket Packer – Extendable Frame	3,108	\$9,802.00
BJ1618C	16'	Sprocket Packer – Solid Frame	3,250	\$10,922.00

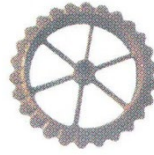

40 lbs. Each

Single Gang Packer with 19" Ductile Notched Wheels

Scrapers Per Foot - \$87.00

Model	Coverage	Description	Weight (lbs)	Price
BJ319	3'	Notched Wheel Packer Pup	719	\$2,582.00
BJ419	4'	Notched Wheel Packer Pup	909	\$3,207.00
BJ519	5'	Notched Wheel Packer Pup	1,088	\$4,244.00
BJ619	6'	Notched Wheel Packer Pup	1,238	\$4,352.00
BJ919C	9'	Notched Wheel Packer – Extendable Frame	1,845	\$6,544.00
BJ1019C	10'	Notched Wheel Packer – Extendable Frame	2,064	\$7,013.00
BJ1119C	11'	Notched Wheel Packer – Extendable Frame	2,206	\$7,481.00
BJ1219C	12'	Notched Wheel Packer – Extendable Frame	2,424	\$7,953.00
BJ1319C	13'	Notched Wheel Packer – Extendable Frame	2,562	\$8,422.00
BJ1419C	14'	Notched Wheel Packer – Extendable Frame	2,700	\$8,889.00
BJ1519C	15'	Notched Wheel Packer – Extendable Frame	2,883	\$9,357.00
BJ1619C	16'	Notched Wheel Packer – Solid Frame	3,010	\$10,566.00



45 lbs. Each

Single Gang Packer with 20" Ductile Crowfoot Wheels

Model	Coverage	Description	Weight (lbs)	Price
BJ320	3'	Crowfoot Packer Pup	529	\$2,227.00
BJ420	4'	Crowfoot Packer Pup	639	\$2,869.00
BJ520	5'	Crowfoot Packer Pup	749	\$3,513.00
BJ620	6'	Crowfoot Packer Pup	859	\$4,164.00
BJ920C	9'	Crowfoot Packer – Extendable Frame	1,235	\$5,635.00
BJ1020C	10'	Crowfoot Packer – Extendable Frame	1,288	\$6,001.00
BJ1120C	11'	Crowfoot Packer – Extendable Frame	1,461	\$6,364.00
BJ1220C	12'	Crowfoot Packer – Extendable Frame	1,612	\$6,729.00
BJ1320C	13'	Crowfoot Packer – Extendable Frame	1,682	\$7,093.00
BJ1420C	14'	Crowfoot Packer – Extendable Frame	1,752	\$7,454.00
BJ1520C	15'	Crowfoot Packer – Extendable Frame	1,868	\$7,816.00
BJ1620C	16'	Crowfoot Packer – Solid Frame	2,012	\$8,648.00



Transport Kits

- Bolts to single gang packers with 4” x 4” frame
- **Consists of:** 3000 PSI Cylinders, hoses and couplers, 15” x 6” x 6-bolt rims with 9.5L-15 tires, 4000 lb. hubs, implement jack, safety chain, SMV sign and all necessary hardware for installation.

Model	Description	Weight (lbs)	Price
BJ330	Transport Kit (Single Wheel)	390	\$3,732.00
BJ330-D	Transport Kit (Dual Wheel)	470	\$4,815.00
BJ331-D	Transport Kit (16 Foot Dual Wheel)	470	\$4,846.00
BJLK	LED Light Kit		\$616.00
Set Up	\$191.00 Dealer Net		

Three Point Hitch Packer (New Models)

Choose required model from above price list and add 3 PTH to model number. For example: BJ1419C-3PTH comes less tongue and braces.

Use same prices as on standard single gang packers.

Three Point Hitch Kit (In Service Packers)

Consists of: Lower link brackets, u-bolt mount, centre link post, rear tow hitch, all necessary mounting hardware and jack stand.

Does not include pins.

BJ173 95 lbs. \$970.00



FOLDING WHEEL PACKERS

BIG JIM VERTICAL packers available in sizes 16 to 20 feet and VERTICAL FLEX WING packers available in 21 to 50 feet, feature the same high quality ductile wheels as our single gang packers.

- Floating gangs to contour ground better
- Transport wheels ahead of centre gang for reduced tongue weight
- Heavy tubular frame construction
- Improved centre gang flotation for reduced stress on centre packer wheels
- Packer guaranteed to meet footage noted
- **Colour Options: Red, Green, Blue & Orange**

Standard Equipment:

- 3000 PSI cylinders, hoses & couplers
- 7000 lb drop leg tongue jack
- Highway lights & reflective tape
- 3 year limited warranty on ductile wheels
- Greasable wheel gang bearings
- Perfect hitch – forged, adjustable pintle/clevis
- DOT tagged safety chains
- 9.5L – 15 8-Ply Tires (16-20 foot models)
- 11L – 15 8-Ply Tires (21-40 foot models)

Note: See below for standard hydraulic set up and optional hydraulic configurations available for each model of packer.

Big Jim Optional Hydraulic Folding Packages

Package	List
<u>Mini V Packer – 16 – 20 feet #BJHPMV1</u> Standard hydraulics includes 1 set of hoses, controls, wings & wheel legs Hydraulic option #1 includes 2 sets of hoses – 1 for wings & 1 for wheel legs	\$536.00
<u>3 Section Vertical Fold Packer – 21 – 32 feet #BJHPVF1</u> Standard hydraulics includes 1 set of hoses, controls, wings & wheel legs Hydraulic option #1 includes 2 sets of hoses – 1 for wings & 1 for wheel legs	\$642.00
<u>5 Section Vertical Fold Packer – 32 – 40 feet #BJHPDVF1</u> Standard hydraulics includes 2 sets of hoses – 1 set for inner wing & wheel legs, 1 set for outer wings Hydraulic option #1 includes 3 sets of hoses – 1 set for inner wings, 1 set for outer wings & 1 set for wheel legs	\$1,178.00



18" – 50 lbs. / Set

Helpful Tip:

Model Number Abbreviations:

MV = Mini Vertical Fold

VF = Vertical Fold

DVF = Double Wing Vertical Fold

Mini Vertical Fold with 18" Ductile Smooth/Sprocket Wheel Combination

Model	Coverage	Description	Weight (lbs)	Transport Width	Transport Height	Price
BJ1816MV	16'	Vertical Fold Packer	3,945	11' 6"		\$24,006.00
BJ1817MV	17'	Vertical Fold Packer	4,084	11' 6"		\$24,573.00
BJ1818MV	18'	Vertical Fold Packer	4,223	11' 6"		\$25,125.00
BJ1819MV	19'	Vertical Fold Packer	4,362	11' 6"		\$25,783.00
BJ1820MV	20'	Vertical Fold Packer	4,501	11' 6"		\$26,930.00

3 Section Super Flex Packer with 18" Ductile Smooth/Sprocket Wheel Combination

Model	Coverage	Description	Weight (lbs)	Transport Width	Transport Height	Price
BJ1821VF	21'	3 Section Super Flex Packer	6,624	12' 8"	10'	\$31,625.00
BJ1822VF	22'	3 Section Super Flex Packer	6,772	12' 8"	10' 6"	\$32,942.00
BJ1823VF	23'	3 Section Super Flex Packer	7,020	12' 8"	11'	\$34,260.00
BJ1824VF	24'	3 Section Super Flex Packer	7,168	12' 8"	11' 6"	\$35,559.00
BJ1825VF	25'	3 Section Super Flex Packer	7,416	12' 8"	12'	\$36,861.00
BJ1826VF	26'	3 Section Super Flex Packer	7,776	12' 8"	12' 6"	\$38,648.00
BJ1827VF	27'	3 Section Super Flex Packer	8,024	12' 8"	13'	\$39,950.00
BJ1828VF	28'	3 Section Super Flex Packer	8,172	14' 8"	12' 6"	\$41,254.00
BJ1829VF	29'	3 Section Super Flex Packer	8,420	14' 8"	13'	\$42,553.00
BJ1830VF	30'	3 Section Super Flex Packer	8,648	16' 8"	12' 6"	\$43,852.00
BJ1831VF	31'	3 Section Super Flex Packer	8,896	16' 8"	13'	\$45,153.00
BJ1832VF	32'	3 Section Super Flex Packer	9,044	16' 8"	13' 6"	\$46,376.00

5 Section Super Flex Packer with 18" Ductile Smooth/Sprocket Wheel Combination

Model	Coverage	Description	Weight (lbs)	Transport Width	Transport Height	Price
BJ1833DVF	33'	5 Section Super Flex Packer	9,544	14' 8"	10' 9"	\$52,092.00
BJ1834DVF	34'	5 Section Super Flex Packer	9,692	14' 8"	10' 9"	\$53,056.00
BJ1835DVF	35'	5 Section Super Flex Packer	9,940	14' 8"	11' 3"	\$54,017.00
BJ1836DVF	36'	5 Section Super Flex Packer	10,188	14' 8"	11' 3"	\$54,981.00
BJ1837DVF	37'	5 Section Super Flex Packer	10,336	14' 8"	11' 9"	\$55,943.00
BJ1838DVF	38'	5 Section Super Flex Packer	10,584	14' 8"	11' 9"	\$56,907.00
BJ1839DVF	39'	5 Section Super Flex Packer	10,732	14' 8"	12' 3"	\$57,865.00
BJ1840DVF	40'	5 Section Super Flex Packer	10,980	14' 8"	12' 3"	\$58,833.00
BJ1842DVF	42'	5 Section Super Flex Packer	11,270	14' 8"	12' 9"	\$60,019.00
BJ1845DVF	45'	5 Section Super Flex Packer	11,810	16' 8"	13'	\$62,781.00

FOB HARRISTON – DESIGN & PRICE ARE SUBJECT TO CHANGE WITHOUT NOTICE



40 lbs. Each; 3 Per Foot

Helpful Tip:

Model Number Abbreviations:

MV = Mini Vertical Fold

VF = Vertical Fold

DVF = Double Wing Vertical Fold

Scrapers \$87.00 per foot

Mini Vertical Fold with 19" Notched Ductile Wheels

Model	Coverage	Description	Weight (lbs)	Transport Width	Transport Height	Price
BJ1916MV	16'	Vertical Fold Packer	3,945	11' 6"		\$23,213.00
BJ1917MV	17'	Vertical Fold Packer	4,084	11' 6"		\$23,815.00
BJ1918MV	18'	Vertical Fold Packer	4,223	11' 6"		\$24,169.00
BJ1919MV	19'	Vertical Fold Packer	4,362	11' 6"		\$24,700.00
BJ1920MV	20'	Vertical Fold Packer	4,501	11' 6"		\$25,760.00

3-Section Super Flex Packer with 19" Notched Ductile Wheels

Model	Coverage	Description	Weight (lbs)	Transport Width	Transport Height	Price
BJ1921VF	21'	3 Section Super Flex Packer	5,994	12' 8"	10'	\$28,295.00
BJ1922VF	22'	3 Section Super Flex Packer	6,202	12' 8"	10' 6"	\$29,584.00
BJ1923VF	23'	3 Section Super Flex Packer	6,330	12' 8"	11'	\$31,041.00
BJ1924VF	24'	3 Section Super Flex Packer	6,538	12' 8"	11' 6"	\$32,375.00
BJ1925VF	25'	3 Section Super Flex Packer	6,666	12' 8"	12'	\$33,700.00
BJ1926VF	26'	3 Section Super Flex Packer	6,874	12' 8"	12' 6"	\$35,517.00
BJ1927VF	27'	3 Section Super Flex Packer	7,002	12' 8"	13'	\$36,847.00
BJ1928VF	28'	3 Section Super Flex Packer	7,210	14' 8"	12' 6"	\$38,176.00
BJ1929VF	29'	3 Section Super Flex Packer	7,338	14' 8"	13'	\$39,506.00
BJ1930VF	30'	3 Section Super Flex Packer	7,626	16' 8"	12' 6"	\$41,037.00
BJ1931VF	31'	3 Section Super Flex Packer	7,754	16' 8"	13'	\$42,368.00
BJ1932VF	32'	3 Section Super Flex Packer	7,962	16' 8"	13' 6"	\$43,697.00

5-Section Super Flex Packer with 19" Notched Ductile Wheels

Model	Coverage	Description	Weight (lbs)	Transport Width	Transport Height	Price
BJ1933DVF	33'	5 Section Super Flex Packer	8,564	14' 8"	10' 9"	\$48,308.00
BJ1934DVF	34'	5 Section Super Flex Packer	8,772	14' 8"	10' 9"	\$49,212.00
BJ1935DVF	35'	5 Section Super Flex Packer	8,900	14' 8"	11' 3"	\$50,551.00
BJ1936DVF	36'	5 Section Super Flex Packer	9,108	14' 8"	11' 3"	\$51,874.00
BJ1937DVF	37'	5 Section Super Flex Packer	9,236	14' 8"	11' 9"	\$53,200.00
BJ1938DVF	38'	5 Section Super Flex Packer	9,444	14' 8"	11' 9"	\$54,536.00
BJ1939DVF	39'	5 Section Super Flex Packer	9,572	14' 8"	12' 3"	\$55,865.00
BJ1940DVF	40'	5 Section Super Flex Packer	9,780	14' 8"	12' 3"	\$57,197.00
BJ1942DVF	42'	5 Section Super Flex Packer	10,040	14' 8"	12' 9"	\$58,601.00
BJ1945DVF	45'	5 Section Super Flex Packer	10,508	16' 8"	13'	\$61,341.00

FOB HARRISTON – DESIGN & PRICE ARE SUBJECT TO CHANGE WITHOUT NOTICE



45 lbs. Each; 2 Per Foot

Helpful Tip:

Model Number Abbreviations:

MV = Mini Vertical Fold

VF = Vertical Fold

DVF = Double Wing Vertical Fold

Mini Vertical Fold with 20" Ductile Crowfoot Wheels

Model	Coverage	Description	Weight (lbs)	Transport Width	Transport Height	Price
BJ2020MV	16'	Vertical Fold Packer	3,300	11' 6"		\$20,607.00
BJ2017MV	17'	Vertical Fold Packer	3,471	11' 6"		\$21,000.00
BJ2018MV	18'	Vertical Fold Packer	3,602	11' 6"		\$21,410.00
BJ2019MV	19'	Vertical Fold Packer	3,730	11' 6"		\$21,789.00
BJ2020MV	20'	Vertical Fold Packer	3,866	11' 6"		\$22,152.00

3-Section Super Flex Packer with 20" Ductile Crowfoot Wheels

Model	Coverage	Description	Weight (lbs)	Transport Width	Transport Height	Price
BJ2021VF	21'	3 Section Super Flex Packer	5,150	12' 8"	10'	\$25,456.00
BJ2022VF	22'	3 Section Super Flex Packer	5,289	12' 8"	10' 6"	\$26,595.00
BJ2023VF	23'	3 Section Super Flex Packer	5,427	12' 8"	11'	\$28,018.00
BJ2024VF	24'	3 Section Super Flex Packer	5,565	12' 8"	11' 6"	\$29,155.00
BJ2025VF	25'	3 Section Super Flex Packer	5,703	12' 8"	12'	\$30,291.00
BJ2026VF	26'	3 Section Super Flex Packer	6,043	12' 8"	12' 6"	\$31,669.00
BJ2027VF	27'	3 Section Super Flex Packer	6,181	12' 8"	13'	\$32,808.00
BJ2028VF	28'	3 Section Super Flex Packer	6,319	14' 8"	12' 6"	\$33,946.00
BJ2029VF	29'	3 Section Super Flex Packer	6,457	14' 8"	13'	\$35,086.00
BJ2030VF	30'	3 Section Super Flex Packer	6,675	16' 8"	12' 6"	\$37,524.00
BJ2031VF	31'	3 Section Super Flex Packer	6,813	16' 8"	13'	\$39,964.00
BJ2032VF	32'	3 Section Super Flex Packer	6,951	16' 8"	13' 6"	\$42,403.00

5-Section Super Flex Packer with 20" Ductile Crowfoot Wheels

Model	Coverage	Description	Weight (lbs)	Transport Width	Transport Height	Price
BJ2033DVF	33'	5 Section Super Flex Packer	7,614	14' 8"	10' 9"	\$43,193.00
BJ2034DVF	34'	5 Section Super Flex Packer	7,752	14' 8"	10' 9"	\$44,380.00
BJ2035DVF	35'	5 Section Super Flex Packer	7,890	14' 8"	11' 3"	\$45,574.00
BJ2036DVF	36'	5 Section Super Flex Packer	8,028	14' 8"	11' 3"	\$46,758.00
BJ2037DVF	37'	5 Section Super Flex Packer	8,166	14' 8"	11' 9"	\$47,950.00
BJ2038DVF	38'	5 Section Super Flex Packer	8,304	14' 8"	11' 9"	\$49,134.00
BJ2039DVF	39'	5 Section Super Flex Packer	8,442	14' 8"	12' 3"	\$50,320.00
BJ2040DVF	40'	5 Section Super Flex Packer	8,580	14' 8"	12' 3"	\$51,507.00
BJ2042DVF	42'	5 Section Super Flex Packer	8,740	14' 8"	12' 9"	\$52,855.00
BJ2045DVF	45'	5 Section Super Flex Packer	9,020	16' 8"	13' 3"	\$56,729.00
BJ2048DVF	48'	5 Section Super Flex Packer	9,470	16' 8"	13' 9"	\$60,285.00
BJ2050DVF	50'	5 Section Super Flex Packer	9,770	16' 8"	14' 3"	\$61,426.00



SUPERFLEX MAGNUM PACKERS

5 Section Superflex Magnum with 18" Ductile Smooth/Sprocket Wheel Combination					
Model	Coverage	Description	Approximate Weight (lbs)	Transport Width	Price
BJ1845VFM	45'	5 Section Superflex Magnum Packer	16,234	16' 8"	\$84,857.00
BJ1848VFM	48'	5 Section Superflex Magnum Packer	16,945	16' 8"	\$87,458.00
BJ1850VFM	50'	5 Section Superflex Magnum Packer	17,452	16' 8"	\$89,182.00

Scrapers Per Foot - \$90.00

5 Section Superflex Magnum with 19" Ductile Notched Wheels					
Model	Coverage	Description	Approximate Weight (lbs)	Transport Width	Price
BJ1945	45'	5 Section Superflex Magnum Packer	14,873	16' 8"	\$81,968.00
BJ1948	48'	5 Section Superflex Magnum Packer	15,499	16' 8"	\$84,353.00
BJ1950	50'	5 Section Superflex Magnum Packer	15,934	16' 8"	\$85,935.00



DRUM ROLLERS

Big Jim Drum Rollers are made in-house at Harriston, Ontario. All rollers from 4 feet to 34 feet use a 30" diameter x 3/8" wall tube for the drum.

Heavy Duty Lawn Rollers

The Heavy Duty Lawn Rollers feature 3/8" drum material, 1" centre shaft, and bearings with pressed steel flanges, 10 gauge end plates, 1 1/4" fill plug and 3/4" vent plug, formed side plates, 2" x 2" tongue and front tube.

Model	Description	Dry Weight (lbs)	Price
BJLR4-HD	4' Heavy Duty Lawn Roller	606	\$1,822.00
BJLR5-HD	5' Heavy Duty Lawn Roller	733	\$2,107.00
BJLR6-HD	6' Heavy Duty Lawn Roller	864	\$2,409.00

Colour Options are available during Early Order Program ONLY

Colour Options: Red, Green, Blue & Orange

Extra Heavy Duty Lawn Rollers

The Extra Heavy Duty Lawn Rollers feature 3/8" drum material, 1 3/4" centre shaft and greaseable pillow block bearings, 1/4" end plates, 1 1/4" fill plug and 3/4" vent plug, 2" x 2" tubular tongue and frame.

Model	Description	Dry Weight (lbs)	Price
BJLR4-EHD	4' Extra Heavy Duty Lawn Roller	720	\$2,440.00
BJLR5-EHD	5' Extra Heavy Duty Lawn Roller	857	\$2,739.00
BJLR6-EHD	6' Extra Heavy Duty Lawn Roller	998	\$3,046.00
BJLR7-EHD	7' Extra Heavy Duty Lawn Roller	1,135	\$3,336.00
BJLR8-EHD	8' Extra Heavy Duty Lawn Roller	1,272	\$3,642.00

Colour Options: Red, Green, Blue & Orange

Note: Drum holds 4.666 cubic feet per foot. Water at 62.5 lbs. per cubic foot adds 291.61 lbs. per foot.



SINGLE GANG ROLLERS

Single Gang Rollers feature standard scrapers, 1 3/4" bearing shaft, double end plates (outer 3/8" thick and inner 1/4" thick), SMV sign mount bracket, welded clevis hitch, 4" x 4" x 1/4" tubular frame, 1 3/4" flanged bearings and reflective tape.

Colour Options: Red, Green, Blue & Orange

Model	Coverage	Description	Weight (lbs.)	Price
BJDR09	9' 6"	Single Gang Roller	2,213	\$6,629.00
BJDR10	10' 6"	Single Gang Roller	2,362	\$7,089.00
BJDR11	11' 6"	Single Gang Roller	2,511	\$7,545.00
BJDR12	12' 6"	Single Gang Roller	2,660	\$8,003.00
BJDR13	13' 6"	Single Gang Roller	2,809	\$8,460.00
BJDR14	14' 6"	Single Gang Roller	2,958	\$8,916.00
BJDR15	15' 6"	Single Gang Roller	3,107	\$9,376.00
BJDR16	16' 6"	Single Gang Roller	3,256	\$9,832.00

Transport Kits – 3000 PSI cylinders, hoses & couplers, 15" wheels w/9.5L-15 8-ply and tube, DOT safety chain, SMV sign, mount & bracket, 5000 lb. top wind jack

Model	Description	Weight (lbs.)	Price
BJDR332	Transport Kit	390	\$3,754.00
BJDR332-D	Transport Kit – Dual Wheel	470	\$5,058.00
BJLK	LED Light Kit		\$660.00

Dealer: Allow 1.5 hours for final assembly



FOLDING ROLLERS

Big Jim Folding Rollers feature standard scrapers, 6" x 6" x 1/4" wall tubular main frame, 6" x 4" x 1/4" wall wing frames, 2-7/16" bearing shafts, 2-7/16" greaseable ductile pillow block bearings, 3000 PSI cylinders, hoses and couples, 6" x 4" x 3/8" wall tongue (26' – 34' models), 6" x 4" x 1/4" wall tongue (20' – 25' models), 11L – 15, 8-Ply Tires x 4, "PERFECT HITCH" – Forged adjustable clevis, safety chains, transport lights, SMV mount bracket and reflective tape all standard.



Colour Options: **Red, Green, Blue & Orange**

Model	Coverage	Description	Weight (lbs.)	Transport Width	Transport Height	Price
BJDR20	20' 6"	Folding	6,602	12'	9'6"	\$34,688.00
BJDR21	21' 6"	Folding	6,756	12'	10'	\$35,140.00
BJDR22	22' 6"	Folding	6,910	12'	10' 6"	\$35,589.00
BJDR23	23' 6"	Folding	7,064	12'	11'	\$36,036.00
BJDR24	24' 6"	Folding	7,218	12'	11' 6"	\$36,488.00
BJDR25	25' 6"	Folding	7,672	12'	12'	\$36,932.00
BJDR26	26' 6"	Folding	7,826	14'	11' 6"	\$37,385.00
BJDR27	27' 6"	Folding	7,980	14'	12'	\$37,828.00
BJDR28	28' 6"	Folding	8,134	14'	12' 6"	\$38,281.00
BJDR29	29' 6"	Folding	8,288	14'	13'	\$38,730.00
BJDR30	30' 6"	Folding	8,442	14'	13' 6"	\$39,177.00
BJDR31	31' 6"	Folding	8,596	16'	13'	\$39,628.00
BJDR32	32' 6"	Folding	8,750	16'	13' 6"	\$39,926.00
BJDR33	33' 6"	Folding	8,904	16'	14'	\$40,289.00
BJDR34	34' 6"	Folding	9,058	16'	14' 6"	\$42,273.00



5808 Hwy #9, Harriston, Ontario, N0G 1Z0
Phone: 519-338-2923, Fax: 519-338-2756
Email: sales@harcoag.ca
www.harcoag.ca



MUNICIPAL PARK ROLLER

Model	Description	Weight (lbs.)	Price
BJDR7	7 Foot Roller	1,637	\$5,636.00
BJDR8	8 Foot Roller	1,780	6,048.00

Trans kits include complete hydraulic system, DOT safety chain, SMV sign, mount bracket, 9.5L-15 tires with wheels.

OPTIONS		
Model	Description	Price
BJ333	Single Wheel Transport Kit	\$4,385.00
BJ333-D	Dual Wheel Transport Kit	\$4,992.00
BJLK	LED Light Kit	\$660.00
BJSH	Swivel Hitch	\$241.00
TC0336	9.5L – 15, Highway Service	\$220.00 each
TC0338	31 x 10.5 R15LT, Truck Tire	\$200.00 each

Dealer: Allow 1.5 hours for final assembly
Colour Options: **Red**, **Green**, **Blue** & **Orange**





740 SERIES POST DRIVER



Big Jim 740-3PH, 3 Point Hitch / Skid Steer Mount Post Driver

Approx. Weight
1,697 lbs.

List
\$13,659.00

Standard Equipment & Features

- 4-Way Mast Tilt
- 740 lb. Hammer Assembly
- 2 Position Bolt on Hammer
- Maximum Post Diameter 10 Inches
- Hydraulic Post Hugger
- 4 Handle Control Valve (4 independent)
- Minimum 10 gpm Required

****Add one attachment option from below to complete the machine****

BJ3PH	3-Point Hitch Attachment Kit	30 lbs.	\$319.00
BJQT	Universal Skid Steer Attachment Kit	150 lbs.	\$1,000.00
BJSSQT	Side Shift (8") Universal Skid Steer Attachment Kit	420 lbs.	\$3,375.00



<u>Big Jim 740-T, Gas Powered Trailer Type Post Driver</u>	<u>Approx. Weight</u> 3,748 lbs.	<u>List</u> \$24,121.00
-------------------------------------------------------------------	---------------------------------------------------	------------------------------------------

Standard Equipment & Features

- | | |
|------------------------------------------------------------------------------------------------------------------------------------------------------------------------------------------------------------------------------------------------------------------------------------------------------------|--------------------------------------------------------------------------------------------------------------------------------------------------------------------------------------------------------------------|
| <ul style="list-style-type: none"> ▪ 16" Tongue Travel ▪ 16" In/Out Mast Travel ▪ 4-Way Mast Tilt ▪ 740 lb. Hammer Assembly ▪ 2 Position Bolt On Hammer ▪ Hydraulic Post Hugger ▪ 4-Handle Control Valve (2 Joystick – 2 Independent) | <ul style="list-style-type: none"> ▪ 978 lb. Counter Weight ▪ 15 Gallon Oil Reservoir ▪ Post Carrier Rack ▪ 9.5L-15 Highway Rated Tires ▪ 13 HP Honda GX Engine |
|------------------------------------------------------------------------------------------------------------------------------------------------------------------------------------------------------------------------------------------------------------------------------------------------------------|--------------------------------------------------------------------------------------------------------------------------------------------------------------------------------------------------------------------|

<u>Big Jim 740-T Plus, Gas Powered Trailer Type Post Driver</u> <i>Adjusts 'on the go' for 8 or 10 foot posts. Using the 10' mode will start and drive 8 foot posts 50% faster!</i>	<u>Approx. Weight</u> 4,440 lbs.	<u>List</u> \$27,744.00
-----------------------------------------------------------------------------------------------------------------------------------------------------------------------------------------------	---------------------------------------------------	------------------------------------------

Standard Equipment & Features

- | | |
|-----------------------------------------------------------------------------------------------------------------------------------------------------------------------------------------------------------------------------------------------------------------------------------------------------------------------------------------------|-------------------------------------------------------------------------------------------------------------------------------------------------------------------------------------------------------------------------------------------------------------------------------------|
| <ul style="list-style-type: none"> ▪ 24" Tongue Travel ▪ 16" In/Out Mast Travel ▪ 4-Way Mast Tilt ▪ 24" Hydraulic Life Mast ▪ 740 lb. Hammer Assembly ▪ 2 Position Bolt On Hammer ▪ Hydraulic Post Hugger ▪ 6-Handle Control Valve (2 Joystick – 4 Independent) | <ul style="list-style-type: none"> ▪ 1,306 lb. Counter Weight ▪ 15 Gallon Oil Reservoir ▪ Post Carrier Rack ▪ Storage/Toolbox ▪ 9.5L-15 Highway Rated Tires ▪ 13 HP Honda GX Engine ▪ Hydraulic Stabilizer Arm |
|-----------------------------------------------------------------------------------------------------------------------------------------------------------------------------------------------------------------------------------------------------------------------------------------------------------------------------------------------|-------------------------------------------------------------------------------------------------------------------------------------------------------------------------------------------------------------------------------------------------------------------------------------|

Options

BJSRPH	Square / Round Combination Post Hugger (in lieu of round)	35 lbs.	\$263.00
--------	--------------------------------------------------------------	---------	----------



FORESTRY WINCHES



Twenty years in the forestry winch business has given Harco a tremendous insight into the needs of customers in Eastern Canada and U.S.A. We have designed our Big Jim series winch with that in mind and came up with a winch that is stronger in several areas & is more ergonomically appealing to the customer. Our brochure lists many significant improvements in winch design and we are sure you will find much lower cost of service and repair as the Big Jim Winch uses North American bearings, drive chains & sprockets.

FW8800

Winch complete with 166 feet of cable and hook, PTO shaft, D handle pull control and free swinging upper pulley assembly, protective screen.

Weight (lbs.)	List
764	\$6,098.00

Options

	Weight (lbs.)	List
BJCC10	Choker Chains – 10'	\$114.00
BJCC7	Choker Chains – 7'	\$90.00
BJCC7A	Choker Cable – 7' x 7/16"	\$55.00
BJCCSA	Choker Cable – 5' x 7/16"	\$49.00
BJCCV	Sliding Hook	\$34.00
BJCA7166	7/16" x 166' Replacement Cable	\$418.00



LIQUID FERTILIZER APPLICATOR



Features:

- ▶ Tubular Steel Frame Construction
- ▶ Convertible Hitch Clevis
- ▶ Transverse Mounted Tank
- ▶ LED Implement Lights
- ▶ Tire-to-Tire Pump Drive
- ▶ 2" Bottom Fill Plumbing
- ▶ Rockshaft Lift System
- ▶ Safety Chain
- ▶ 12.4 x 24 Tires
- ▶ Blu-Jet® Coulters
- ▶ John Blue Piston Pump
- ▶ 300 or 500 Gallon Tank Capacity
- ▶ Knife or Stream Injection
- ▶ Fixed 60" or 90" Axles
- ▶ Adjustable Axle of 60"-90"



Continued...



****Select One Item from Each Section****

Section 1		
Model	Description	Price
BJLA00100	Base Unit	\$7,783.00

Section 2		
Model	Description	Price
BJLA00105	300 Gallon Tank	\$3,272.00
BJLA00106	500 Gallon Tank	\$4,015.00

Section 3		
Model	Description	Price
BJLA00102	60" Fixed Axle	\$5,923.00
BJLA00104	80" Fixed Axle	\$6,007.00
BJLA00111	90" Fixed Axle	\$6,099.00
BJLA00103	60"-90" Adjustable Axle	\$7,549.00

Section 4		
Model	Description	Price
BJLA00107	5R30 Fixed Tool Bar	\$5,623.00
BJLA00110	7R30 Fixed Tool Bar	\$7,211.00
BJLA00108	5R30 Folding Tool Bar	\$9,548.00
BJLA00109	7R30 Folding Tool Bar	\$11,131.00

****For Different Row Spacing Configurations contact Harco Ag****

Section 5		
Model	Description	Price
LA0134	Coulter/Stream Injection	\$263.00
LA0133	Coulter/Knife Injection	\$333.00

Price Per Row

Section 6		
Model	Description	Price
BJLA00101	Single Piston Pump, Drive, Plumbing	\$7,931.00
BJLA00112	Double Piston Pump, Drive, Plumbing	\$9,341.00



PULL TYPE CULTIVATOR

Features:

- ▶ 2 1/2" x 1/4" Wall Tubular Frame
- ▶ Adjustable Clevis Style Hitch
- ▶ DOT Approved Safety Chain
- ▶ Complete Hydraulic Package
- ▶ Heavy Duty 45 x 12 x 660 mm 'S' tines
- ▶ 7.60 – 15 Implement Tires with Tubes
- ▶ Tongue Jack



Model	Description	Approx. Weight (lbs.)	Set Up (Net)	Price
BJSTC7-4	<ul style="list-style-type: none"> - 7' Base Unit - 4" Tine Centres - 21 Tines - 2 3/4" Sweeps 	1,055	\$450.00	\$7,670.00
BJSTC7-6	<ul style="list-style-type: none"> - 7' Base Unit - 6" Tine Centres - 15 Tines - 2 3/4" Sweeps 	973	\$425.00	\$7,052.00
BJEXT2-4	<ul style="list-style-type: none"> - 2' Extension Kit for 9' Coverage - 4" Tine Centres - 6 Tines - 2 3/4" Sweeps 	140	\$50.00	\$957.00
BJEXT2-6	<ul style="list-style-type: none"> - 2' Extension Kit for 9' Coverage - 6" Tine Centres - 4 Tines - 2 3/4" Sweeps 	95	\$45.00	\$768.00
BJEXT4-4	<ul style="list-style-type: none"> - 4' Extension Kit for 11' Coverage - 4" Tine Centres - 12 Tines - 2 3/4" Sweeps 	336	\$70.00	\$1,871.00
BJEXT4-6	<ul style="list-style-type: none"> - 4' Extension Kit for 11' Coverage - 6" Tine Centres - 8 Tines - 2 3/4" Sweeps 	275	\$60.00	\$1,601.00

5808 Hwy #9, Harriston, Ontario, N0G 1Z0
Phone: 519-338-2923, Fax: 519-338-2756
Email: sales@harcoag.ca
www.harcoag.ca



MULTI-PURPOSE GRAPPLE

The Big Jim Multi-Purpose Grapple is available with Frey, Alo, Skid Steer quick attach brackets and universal pin brackets (1" diameter pin). The grapple consists of 1" thick x 5" deep outside teeth and 3/4" x 5" deep inner teeth. Teeth are tied together with 1 3/4" and 1" diameter round bars and reinforced with 4" x 2" x 1/4" wall tubing on back side of grapple. Teeth are spaced on 12" centres to allow dirt to pass through, but still pick up branches, roots and many other objects. Several different upper claw options are available to suit the customer's specific requirements.

Basic unit includes 3000 PSI Canadian made hydraulic cylinders and hoses to reach centre of grapple. For complete specifications and dimensions please refer to literature.

Uses:

- ▶ Brush raking or piling
- ▶ Log lifting, piling or loading
- ▶ Orchard pruning, etc.
- ▶ Round and square bale grabbing
- ▶ Moving loose hay and straw
- ▶ Moving scrap metal and tires
- ▶ Bind and dirt free trimming and blocking of tree tops

*Recommended horsepower – 40HP to 120HP

Section 1 – Choose a Grapple

Model	Description	Approx. Weight (lbs.)	Price
BJMPG05	5 Foot Basic	527	\$3,018.00
BJMPG06	6 Foot Basic	611	\$3,216.00
BJMPG07	7 Foot Basic	695	\$3,413.00

Units include cylinder & hoses to centre of grapple

Section 2 – Choose a Claw Option

Model	Description	Approx. Weight (lbs.)	Price
BJMPGSC	Single Claw (2 Required)	35 each	\$293.00 each
BJMPGDC	Double Claw (2 Required)	78 each	\$424.00 each
BJMPG3CS-05	3 Claw Solid Assembly – for 5' Base Unit	237	\$1,145.00
BJMPG3CS-06	3 Claw Solid Assembly – for 6' Base Unit	247	\$1,191.00
BJMPG4CS-07	3 Claw Solid Assembly – for 7' Base Unit	597	\$1,426.00

Section 3 – Choose a Mounting Option

Model	Description	Price
BJMPG-FREY	Bolt on quick attach brackets for Frey Loaders	\$342.00
BJMPG-ALO	Bolt on quick attach brackets for ALO Loaders	\$342.00
BJMPG-SS	Bolt on quick attach brackets for Skid Steer Loaders	\$342.00
BJMPG-BB	Bolt on pin brackets – 1" diameter pins	\$229.00

Larger, Higher Horsepower and Custom Made Models Available On Request!



FORGED BALE SPEAR



Model	Description	Weight (lbs.)	Price
BJSF1565	Big Jim Forged Bale Spear – 49” Tine Bucket Mount	87 lbs.	\$ 599.00
BJSF1566	Big Jim Forged Bale Spear – 39” Tine Bucket Mount		\$ 536.00
BJSF1525	Big Jim 3 Point Forged Bale Spear – 49” Tine		\$ 658.00
BJSF1626	Big Jim 3 Point Forged Bale Spear – 39” Tine		\$ 536.00
ALO 235	Alo Loader Quick Attach Spear – Single		\$ 893.00
ALO 255	Alo Loader Quick Attach Spear – Double		\$1,145.00
Frey 205	Frey Loader Quick Attach Spear – Single		\$ 536.00
Frey 225	Frey Loader Quick Attach Spear – Double		\$1,061.00

CONVEY-ALL

TAB

CONVEY-ALL™

June 2023

Call Harco Ag Equipment
for pricing & availability.

519-338-2923

sales@harcoag.ca

www.harcoag.ca

12" Top End Drive Conveyors (TED)

ITEM #	Model#	Description
650507751	1235 TED	Conveyor 12"X35' Straight Hopper Top Drive
650507753	1240 TED	Conveyor 12"X40' Straight Hopper Top Drive

STANDARD FEATURES

10" x 14 Gauge Tubes
 "A" Frame Undercarriage
 Adjustable Discharge Hood
 12" Belt

DRIVE OPTIONS		Description
503238		Electric Direct Drive kit 700 FPM
503602		Electric Drive with Speed Reduction kit
501199		Hydraulic Drive (c/w motor)

MOTORS		Description
1910000016		5 HP Single Phase Motor
1910000017		5 HP 3 Phase Motor (230/460 volt)
1910000020		5 HP 3 Phase Motor (575 volt)

OPTIONS		
504395		Wind guard for 1235
504337		Wind guard for 1240
504396		Wind Guard and Drip Pan Package 1235
504338		Wind Guard and Drip Pan Package 1240
TC10005743		Brush Kit at drive roller
TC1000RLH		Rubber Lined Hood
504357		Yard Wheel Caster
402246		2 5/16 " Ball Receiver Hitch

CONVEY-ALL™

12" Transfer Conveyors (TC)

Item #	Model#	Description
650507780	1214	Transfer Conveyor 12"X14' FL Hopper
650507780S	1214SS	Transfer Conveyor S/S 12"X14' FL Hopper
650507782	1214RC	Transfer Conveyor 12"X14' Rail Car Hopper
650507782S	1214RCSS	Transfer Conveyor 12"X14' Rail Car Hopper

STANDARD FEATURES

10" x 14 Gauge Tubes
 12" Wide Rubber Belt
 Winch Down Collapsible Hopper (FL Hopper)
 Field Loader Hopper (FL)
 Rail Car Hopper (RC)

DRIVE OPTIONS	Description
503530	Side PTO Drive
504303	Elec. Drive (c/w Pulleys, belts & guards) No Motor
650505011	Gas Drive (c/w Pulleys, belts & guards) No Motor

MOTORS	Description
1920000002	5.5 HP Honda Motor (GX160HX 6:1 Reduction)
1920000006	11 HP Honda W/ 6.1 Reduction
1910000017	5 HP 3 Phase Motor (230/460 volt)
1910000020	5 HP 3 Phase Motor (575 volt)
1910000016	5 HP Single Phase Motor

OPTIONS	Description
503608	Hopper Casters
503533	Swivel Discharge (For swiveling on a leg intake hopper)
402246	2 5/16 " Ball Receiver Hitch
504357	Yard Wheel Caster
650505009	Tow Package (c/w Hwy wheels & tow hitch)
650505013	Tow Hitch Only

CONVEY-ALL™

16" Truck Loader Conveyors (TL)

Motor NOT included

ITEM #	Model#	Description
650507760	1640TL	Conveyor 16"X40' FL Hopper Self Propelled Gas Drive
650507760S	1640TLSS	Conveyor S/S 16"X40' FL Hopper Self Propelled Gas Drive
650506927	1650TL	Conveyor 16"X50' FL Hopper Self Propelled Gas Drive
650506927S	1650TLSS	Conveyor S/S 16"X50' FL Hopper Self Propelled Gas Drive
650507383	1650TLRC	Conveyor 16"x50' Rail Car Hopper Self Propelled Gas Drive
650507383S	1650TLRCSS	Conveyor S/S 16"x50' Rail Car Hopper Self Propelled Gas Drive
650507031	1658TL	Conveyor 16"X58' FL Hopper Self Propelled Gas Drive
650507031S	1658TLSS	Conveyor S/S 16"X58' FL Hopper Self Propelled Gas Drive

Motor NOT included

STANDARD FEATURES		
10" x 14 Gauge Tubes		
"A" Frame Undercarriage		
Field Loader Hopper		
Adjustable Discharge Hood		
16" Wide Chevron Belt		

10" x 14 Gauge Tubes
 "A" Frame Undercarriage
 Field Loader Hopper
 Adjustable Discharge Hood
 16" Wide Chevron Belt

MOTORS		Description
650508087		35HP Kohler Motor includes muffler NET Price
650508088		38HP Kohler EFI Motor includes muffler NET price
650508089		35HP Vanguard Motor includes muffler NET price
650508090		37HP Vanguard EFI Motor includes muffler NET price

OPTIONS		Description
650507319		Light Kit 1650TL
650507342		Light Kit 1658TL
650507320		Electric actuator for discharge hood
13000042071		Cold Weather Pkge 35 Kohler Gas Motor
13000042069		Cold Weather Pkge 35 Vanguard Gas Motor
650508887		stainless steel Ends (in lieu of mild steel)
1865000002		Oil Tank Heater
1865000001		125 Watt Heater for 35 HP Kohler
402246		2 5/16 " Ball Receiver Hitch
503418		RC Hopper w/ Hold down wheels, 1/4" material
504386		Fender & Light Pkg
503326		Quad Adjust Hood Pkge

CONVEY-ALL™

16" Oilseed Truck Loader Conveyors (TL)

Motor NOT included

ITEM #	Model#	Description
650508439	1650TL-Canola	Conveyor 16"X50' FL Canola Hopper SP Gas Drive
650508440	1658TL-Canola	Conveyor 16"X58' FL Canola Hopper SP Gas Drive

Motor NOT included

STANDARD FEATURES		
-------------------	--	--

10" x 14 Gauge Tubes
"A" Frame Undercarriage
Field Loader Hopper
Adjustable Discharge Hood
Belt Scrapers
16" Wide Chevron Belt

MOTORS		Description
650508087		35HP Kohler Motor includes muffler NET Price
650508088		38HP Kohler EFI Motor includes muffler NET price
650508089		35HP Vanguard Motor includes muffler NET price
650508090		37HP Vanguard EFI Motor includes muffler NET price

OPTIONS		Description
650507319		Light Kit 1650TL
650507342		Light Kit 1658TL
650507320		Electric actuator for discharge hood
13000042071		Cold Weather Pkge 35 Kohler Gas Motor
1865000002		Oil Tank Heater
1865000001		125 Watt Heater for 35 HP Kohler
402246		2 5/16 " Ball Receiver Hitch
504386		Fender & Light Pkg

CONVEY-ALL™

16" Field Loader Conveyors (FL)

ITEM #	Model#	Description
650507754	1635FLS	Conveyor 16"X35' FL Hopper side PTO Drive
650507755	1635FLT	Conveyor 16"X35' FL Hopper Top Drive Elec. motor not incl.
650507756	1635FLH	Conveyor 16"X35' FL Hopper Hydraulic Drive Includes Motor
650507757	1635FLE	Conveyor 16"X35' FL Hopper S-Drive Elec. Motor not Incl.
650507758	1635FLG	Conveyor 16"X35' FL Hopper S-Drive Gas Motor not Incl.
650507759	1645FLT	Conveyor 16"X45' FL Hopper Top Drive Elec. Motor not Incl.

STANDARD FEATURES

10" x 14 Gauge Tubes

"A" Frame Undercarriage

Field Loader Hopper

Adjustable Discharge Hood

16" Chevron Belt

Hand Winch Lift

MOTORS	Description
1920000067	23.5 HP Kohler Motor
1910000034	15 HP 3 Phase Motor 1800 RPM (230/460 volt)
1910000036	15 HP 3 Phase Motor 1800 RPM (575 volt)
1910000030	10 HP 1 Phase Motor 1800 RPM

OPTIONS	Description
650508887	stainless steel Ends (in lieu of mild steel)
504357	Yard Wheel Caster
13000042055	Electric Clutch, Gas Dr. 1 1/8 " 3 Groove
402246	2 5/16 " Ball Receiver Hitch
650507319	Light Kit 1650TL

CONVEY-ALL™

16" Belt Conveyors Truck Load Standard Hopper

ITEM #	Model#	Description
650507778	1635TED	Conveyor 16"X35' Straight Hopper Top Drive Motor not Incl.
650507777	1635	Conveyor 16"X35' Straight Hopper S-Drive Motor Not Incl.
650507779	1645	Conveyor 16"X45' Straight Hopper S-Drive Motor Not Incl.

STANDARD FEATURES

10" x 14 Gauge Tubes
 "A" Frame Undercarriage
 16" Wide Rubber Belt
 Adjustable Discharge Hood

DRIVE OPTIONS	Description
503519	Gas Drive (c/w Pulleys, belts & guards) No Motor, 35'
503527	Gas Drive (c/w Pulleys, belts & guards) No Motor, 45'
503332	Electric Drive (c/w Pulleys, belts & guards) No Motor
503530	Side PTO Drive
504191	Hydraulic Drive (c/w motor)

MOTORS	length	Description
1920000067	1635 - 1645	23.5 HP Kohler Motor
1910000051	1635	7.5 HP 3PH Motor 230/460 volt
1910000027	1635	7.5 HP 3PH Motor 575 volt
1910000023	1635	7.5 HP 1PH Motor
1910000029	1645	10 HP 3PH Motor 230/460 volt
1910000033	1645	10 HP 3PH Motor 575 volt

OPTIONS	Description
504357	Yard Wheel Caster
402246	2 5/16 " Ball Receiver Hitch
650507319	Light Kit 1650TL
650507320	Electric actuator for discharge hood
650507651	Brush Kit
650508887	stainless steel Ends (in lieu of mild steel)

CONVEY-ALL™

16" Bin Fill Conveyors (55-100)

ITEM #	Model#	Description
650507748	1655	Conveyor 16"X55' Scissor Lift Positive Pinch Drive
650507749	1665	Conveyor 16"X65' Scissor Lift Positive Pinch Drive
650507750	1670	Conveyor 16"X70' Scissor Lift Positive Pinch Drive
650507752	1675	Conveyor 16"X75' Scissor Lift Positive Pinch Drive
650507763	1685	Conveyor 16"X85' Scissor Lift Positive Pinch Drive
650507764	1690	Conveyor 16"X90' Scissor Lift Positive Pinch Drive
650507765	16100	Conveyor 16"X100' Scissor Lift Positive Pinch Drive No SP

STANDARD FEATURES

10" 12 & 14 Gauge Tubes
 Hydraulic Scissor Lift
 16" Wide Rubber Belt
 Adjustable Discharge Hood
 Standard Hopper

DRIVE OPTIONS	Description
503080	Electric Drive (c/w Pulleys, belts & guards) No Motor, 55' - 100'
504298	End PTO Drive (shear pin protection), All Models
650508014	Diesel Drive w/ Mover no swing
503508	Side PTO Drive (shear pin protection), All Models

MOTORS	Length	Description
1910000034	1655 - 1665	15 HP 3 Phase Motor 1800 RPM (230/460 volt)
1910000036	1655 - 1655	15 HP 3 Phase Motor 1800 RPM (575 volt)
1910000043	1670 - 16100	20 HP, 3 Phase Motor 1800 RPM (230/460 Volt), 70' - 100'
1910000042	1670 - 16100	20 HP, 3 Phase Motor 1800 RPM (575 Volt), 70' - 100'

OPTIONS	Description
650507203	Swing out W/ Elec Mover kit, 85'- 100' End PTO incl.
650505047	Swing Out W/ Hyd. Mover Kit, 85' - 100' End PTO Incl.
650505048	Swing Out, 10", 85' - 100' Includes End PTO
650508031	SP Pkg W/ 50 HP Kubota Tier 4 & hyd Swing Out
504441	SP Pkg W/ 50 HP Kubota Tier 4 & Elec Swing Out
503529	Hyd. Winch for Swing Out /Non SP Units
504354	Wet Kit (Includes Electric Motor)
503816	Hydraulic 90 Degree Hopper Axle
650508267	Electric Drive Swingout Conveyor with Electric hopper mover NO PTO
650508887	stainless steel Ends (in lieu of mild steel)

CONVEY-ALL™

16" Transfer Conveyors (TC)

ITEM #	Model#	Description
650507781	1615	Transfer Conveyor 16"X15' FL Hopper
650507781S	1615SS	Transfer Conveyor S/S 16"X15' FL Hopper
650507783	1616RC	Transfer Conveyor 16"X16' Rail Car Hopper
650507783S	1616RCSS	Transfer Conveyor S/S 16"X16' Rail Car Hopper

STANDARD FEATURES

10" x 14 Gauge Tubes

16" Wide Chevron Rubber Belt

Winch Down Collapsible Hopper (FL)

Winch UP Hopper Flaps (RC)

DRIVE OPTIONS	Description
503243	Countershaft Gas Drive (reqd for 13 HP - motor not included)
501258	Gas Drive (c/w Pulleys, belts & guards) No Motor
501253	Elec. Drive (c/w Pulleys, belts & guards) No Motor
503670	Hydraulic Drive (c/w motor) No Hyd. Hoses

MOTORS	Description
1920000006	11 HP Honda W/ 6.1 Reduction
1920000010	13 HP Honda Electric Start
1910000051	7.5 HP 3PH Motor 230/460 volt
1910000027	7.5 HP 3PH Motor 575 volt
1910000023	7.5 HP 1PH Motor

OPTIONS	Description
504314	Wind guard, Drip Pan Pkg
503608	Hopper Casters
504357	Yard Wheel Caster
402246	2 5/16" Ball Receiver Hitch
650506854	Swivel Discharge (For swiveling on a leg intake hopper)
1920000065	Cent. Clutch For 13 HP Honda

CONVEY-ALL™

22" Bin Fill Conveyors (35-75)

ITEM #	Model#	Description
2235	2235	Conveyor 22"X35' A-Frame Positive Pinch Drive
650507790	2245	Conveyor 22"X45' A-Frame Positive Pinch Drive
650507791	2265	Conveyor 22"X65' Scissor Lift Positive Pinch Drive
650507792	2275	Conveyor 22"X75' Scissor Lift Positive Pinch Drive

STANDARD FEATURES

14" x 12 Gauge Tubes. (304 on SS)

22" Wide Rubber Belt

Spring Tension Standard "S" Drive Box (35-45)

Positive Non-Slip Drive (65-75)

DRIVE OPTIONS	Length	Description
503039	2235 - 2245	Electric Drive (c/w Pulleys, belts & guards) No Motor 45' & Lower
503054	2265 - 2275	Electric Drive kit, 65+
503731		Hydraulic Drive (c/w motor) 45' & Lower
503463		Gas Drive Pkg Requires 35 HP Kohler, 45' & Lower
504212	2265 - 2275	End PTO Drive (c/w shear bolt protection), 65+
650508244		Side Pto Drive Kit

MOTORS	Length	Description
1910000034	2235 - 2255	15 HP 3 Phase Motor 1800 RPM (230/460 volt)
1910000036	2235 - 2255	15 HP 3 Phase Motor 1800 RPM (575 volt)
1910000060	2265	25 HP 1200 RPM (575 volt), 65'
1910000059	2265	25 HP 1200 RPM (230/460 volt), 65'
1910000046	2270 - 2275	30 HP, 1200 RPM (575 Volt), 70' - 75'
1910000061	2270 - 2275	30 HP, 1200 RPM (230/460 Volt), 70' - 75'

OPTIONS	Description
504357	Yard Wheel Caster
503638	Winch Kit for Collapsible Hopper (Main Conveyor)
503132	Hyd. Clevis Hitch
650505114	Wet Kit (Includes Motor) 55' - 110'
650508887	stainless steel Ends (in lieu of mild steel)

CONVEY-ALL™

22" Bin Fill Conveyors (85-120)

ITEM #	Model#	Description
650507793	2285	Conveyor 22"X85' Scissor Lift Positive Pinch Drive
650507794	2290	Conveyor 22"X90' Scissor Lift Positive Pinch Drive
650507795	22100	Conveyor 22"X100' Scissor Lift Positive Pinch Drive
650507796	22110	Conveyor 22"X110' Scissor Lift Positive Pinch Drive
650507797	22120	Conveyor 22"X120' Scissor Lift Positive Pinch Drive

STANDARD FEATURES

14" x 12 Gauge Tubes (304 on SS)
 Hydraulic Scissor Lift
 Spring Tension Standard "S" Drive Box
 Extendable Axles 13'6" to 17'6"
 Positive Non-Slip Drive

DRIVE OPTIONS		Description
503054	2285 - 22120	Electric Drive kit, 65+
504116		Electric Drive kit (c/w belts, pulleys, guards)
650508244		Side Pto Drive Kit
650508483		Diesel Drive w/ Mover no swing 80HP Cummins Diesel
504212		End PTO Drive (c/w shear bolt protection), 65+
650505004		120' End PTO Drive (c/w Shear Bolt Mechanism)

MOTORS		Description
1910000047	2285 - 22110	40 HP 1200 RPM (575 volt)
1910000048	2285 - 22110	40HP 1200 RPM (230/460 volt)
1910000064	22120	50 HP 1200 RPM (575 volt) All Models

OPTIONS		Description
650507439		Swing Out W / 12 Volt Mover & Winch
503638		Winch Kit for Collapsible Hopper (Main Conveyor)
503451		Hyd. Pintle Hitch 120'
503132		Hyd. Clevis Hitch
503529		Hyd. Winch for Swing Out /Non SP Units
503491		HD Rail Rim 2 Req'd
650505114		Wet Kit (Includes Motor) 55' - 110'
503816		Hydraulic 90 Degree Hopper Axle
650508887		stainless steel Ends (in lieu of mild steel)

CONVEY-ALL™

22" Truck Loader Conveyors (TL)

ITEM #	Model#	Description
650507761	2250TL	Conveyor 22"X50' FL Hopper Self Propelled Diesel Drive
650507761S	2250TLSS	Conveyor S/S 22"X50' FL Hopper Self Propelled Diesel Drive
650507766	2258TL	Conveyor 22"X58' FL Hopper Self Propelled Diesel Drive
650507766S	2258TLSS	Conveyor S/S 22"X58' FL Hopper Self Propelled Diesel Drive

STANDARD FEATURES

14" x 12 Gauge Tubes

50HP Kubota Tier 4 Diesel Motor

Hydraulic Belt Drive w/ 4000 Series Motor

Hydraulic Driven Mover W/ 180° Steering VIA Hyd. Cylinder

27 x 10.50 x 15 - 6 Ply Steering Tire

1/4" Hopper Construction

OPTIONS	Description
650507342	Light Kit 1658TL
650507320	Electric actuator for discharge hood
1865000006	500 Watt Oil Tank Heater
650508887	stainless steel Ends (in lieu of mild steel)

CONVEY-ALL™

22" Transfer Conveyors (TC)

ITEM #	Model#	Description
650507785	2218	Transfer Conveyor 22"X18' FL Hopper
650507787	2218RC	Transfer Conveyor 22"X18' Rail Car Hopper
650507787S	2218RCSS	Transfer Conveyor S/S 22"X18' Rail Car Hopper

STANDARD FEATURES

Field Loader Hopper

14" x 12 Gauge Tubes

Only 5" of Clearance Required for Hopper

Winch UP Containment Flaps

Field Loader Hopper (FL)

Rail Car Hopper (RC)

DRIVE OPTIONS	Description
503239	Countershaft Gas Drive (reqd for 13 HP - motor not included)
503671	Gas Drive (c/w Pulleys, belts & guards) No Motor
650505021	Gas Drive (Less Motor)

MOTORS	Description
1920000006	11 HP Honda W/ 6.1 Reduction
1920000010	13 HP Honda Electric Start
1910000029	10 HP 3PH Motor 230/460 volt
1910000033	10 HP 3PH Motor 575 volt
1910000030	10 HP 1 Phase Motor 1800 RPM

OPTIONS	Description
503608	2218 Hopper Casters
402246	2218 2 5/16" Ball Receiver Hitch
504357	2218 Yard Wheel Caster
650505020	2218 Swivel Discharge for leg
1920000065	2218 Cent. Clutch For 13 HP Honda

CONVEY-ALL™

22" Drive Over Conveyors (DO)

ITEM #	Model#	Description
650507676	2228	Drive over Conveyor 22"X28' 5 1/4" Deck Height
2228SS	2228SS	Drive over Conveyor S/S 22"X28' 5 1/4" Deck Height

STANDARD FEATURES

Hydraulic Cylinder Lift on Undercarriage

Standard Discharge Height 35"

Approx. 3980 LBS

5 1/4" Drive Over Clearance

DRIVE OPTIONS	Description
503672	Hydraulic Drive (c/w Motor, Manual Hydraulic Valve)
650505007	Elec. Drive (c/w Motor mount, jack shaft, mounts, guards belts, pulleys)
650505021	Gas Drive (Less Motor)

MOTORS	Description
650508087	35HP Kohler Motor includes muffler NET Price
650508088	38HP Kohler EFI Motor includes muffler NET price
650508089	35HP Vanguard Motor includes muffler NET price
650508090	37HP Vanguard EFI Motor includes muffler NET price
1910000034	15 HP 3 Phase Motor 1800 RPM (230/460 volt)
1910000036	15 HP 3 Phase Motor 1800 RPM (575 volt)

OPTIONS	Description
650507745	Mover Kit Motor NOT Included
1830000109	Wet Kit (c/w hyd pump, valve, mounts, hoses, fittings, (110 VOLT)
1830000110	Wet Kit (c/w hyd pump, valve, mounts, hoses, fittings, (220 VOLT)

CONVEY-ALL™

16" Paddle Belt Conveyors (TCP)

ITEM #	Model#	Description
650507767	TCP 1620	Conveyor 16"X20' Paddle Belt Top Drive 5HP motor not incl.
650507798	TCP 1620S	Conveyor 16"X20' Stand Paddle Belt Top Drive 5HP motor not incl.
650507768	TCP 1625	Conveyor 16"X25' Paddle Belt Top Drive 5HP motor not incl.
650507827	TCP 1625S	Conveyor 16"X25' Stand Paddle Belt Top Drive 5HP motor not incl.
650507769	TCP 1630	Conveyor 16"X30' Paddle Belt Top Drive 7.5HP motor not incl.
650507893	TCP 1630S	Conveyor 16"X30' Stand Paddle Belt Top Drive 7.5HP motor not incl.
650507770	TCP 1635	Conveyor 16"X35' Paddle Belt Top Drive 7.5HP motor not incl.
650507799	TCP 1635S	Conveyor 16"X35' Stand Paddle Belt Top Drive 7.5HP motor not incl.
650507814	TCP 1640	Conveyor 16"X40' Paddle Belt Top Drive 10HP motor not incl.
650507800	TCP 1640S	Conveyor 16"X40' Stand Paddle Belt Top Drive 10HP motor not incl.
650507816	TCP 1645	Conveyor 16"X45' Paddle Belt Top Drive 10HP motor not incl.

MOTOR NOT INCLUDED

STANDARD FEATURES

10" x 14 Gauge Tubes

16" Paddle Belt

Top End Drive Electric w/ Countershaft

Steel Hopper W/ Clean Out

MOTORS	Conveyor	Description
1910000016	1620 - 1625	5 HP Single Phase Motor
1910000017	1620 - 1625	5 HP 3 Phase Motor (230/460 volt)
1910000020	1620 - 1625	5 HP 3 Phase Motor (575 volt)
1910000023	1630 - 1635	7.5 HP 1PH Motor
1910000051	1630 - 1635	7.5 HP 3PH Motor 230/460 volt
1910000027	1630 - 1635	7.5 HP 3PH Motor 575 volt
1910000030	1640 - 1645	10 HP 1 Phase Motor 1800 RPM
1910000029	1640 - 1645	10 HP 3PH Motor 230/460 volt
1910000033	1640 - 1645	10 HP 3PH Motor 575 volt

OPTIONS	Description
504356	Steel Hopper Cover
504157	Collapsible Hopper Option in Lieu of Steel hopper
TCP1600C	10' Base Unit
TCP160CF	Price Per Linear Foot
501346	90" A Frame Stand < 15'
501347	126" A Frame Stand < 20'
501348	162" A Frame Stand <25'
503026	198" A Frame Stand <30'
503027	234" A Frame Stand <35'

CONVEY-ALL™

18" OPEN BED LOW PROFILE CONVEYORS (OBL)

BED SECTIONS		Description
504366		18" Open bed low profile bed kit - 2'
504365		18" Open bed low profile bed kit - 4'
504364		18" Open bed low profile bed kit - 6'
504363		18" Open bed low profile bed kit - 8'
504362		18" Open bed low profile bed kit - 10'
504377		18" Open Bed Low profile Tail Section 10'
1003050014	Per foot	Crescent Rubber Belting 18" Ultimate I 2-PLY 150 WGT

DISCHARGE SPOUT OPTIONS		Description
504408		Low profile discharge spout - 10"
504409		Low profile discharge spout
504410		60 Degree Low profile discharge spout w/ 10" flange

DRIVE OPTIONS		Description
504401		Electric drive up to 40'
504405		In-line reversible drive up to 40'
650505066		Electric drive with gearbox up to 40'
504361		Electric drive 40' - 90'
504293		In-line reversible drive 40' - 90'
650505063		Electric drive with gearbox 40' - 90'
504359		Electric drive 90' and up
504391		In-line reversible drive 90' and up
650505070		Electric drive with gearbox 90' and up

OPTIONS		Description
504389		OBL-18 Meridian bin transition
503145		Discharge stand

- ~ 18" Wide Belt
- ~ 2,900 Bushel per hour at 400 FPM
- ~ Open ben with rollers mild steel
- ~ Stainless Steel available

CONVEY-ALL™

24" OPEN BED LOW PROFILE CONVEYORS (OBL)

BED SECTIONS		Description
504371		24" Open bed low profile bed kit - 2'
504370		24" Open bed low profile bed kit - 4'
504369		24" Open bed low profile bed kit - 6'
504368		24" Open bed low profile bed kit - 8'
504367		24" Open bed low profile bed kit - 10'
504379		24" Open Bed Low profile Tail Section 10'
1003050013	Per Foot	Crescent Rubber Belting 24" 2 ply x Bare MOR

DISCHARGE SPOUT OPTIONS		Description
504424		Low profile horizontal discharge spout
504423		Low profile 14" flanged discharge spout
650406008		Low profile 14" discharge spout

DRIVE OPTIONS		Description
504415		Electric drive up to 40'
504417		Electric drive 40' - 90'
504418		Electric drive 90' and up
504422		In-Line Reversible Drive 90' and up
650505069		Electric drive with gearbox 90' and up

OPTIONS		Description
504389		OBL-18 Meridian bin transition
503333		Discharge stand
37511		Standard Airgate Transition For standard 18" Meridian
40057		High Capacity Airgate Transition For standard 18" Meridian Gate

~ 24" Wide Belt

~ 4,500 Bushel per hour at 400 FPM

~ Open ben with rollers mild steel

~ Stainless Steel available

CONVEY-ALL™

RECOMMENDED HP RATING FOR UNDERBIN CONVEYORS

MOTOR	Length	Description
1910000016	Up to 40'	5 HP Single Phase Motor
1910000017	Up to 40'	5 HP 3 Phase Motor (230/460 volt)
1910000020	Up to 40'	5 HP 3 Phase Motor (575 volt)
1910000023	40 - 65 Feet	7.5 HP 1PH Motor
1910000051	40 - 65 Feet	7.5 HP 3PH Motor 230/460 volt
1910000027	40 - 65 Feet	7.5 HP 3PH Motor 575 volt
1910000030	65 - 90 Feet	10 HP 1 Phase Motor 1800 RPM
1910000029	65 - 90 Feet	10 HP 3PH Motor 230/460 volt
1910000033	65 - 90 Feet	10 HP 3PH Motor 575 volt
1910000034	90 - 130 Feet	15 HP 3 Phase Motor 1800 RPM (230/460 volt)
1910000036	90 - 130 Feet	15 HP 3 Phase Motor 1800 RPM (575 volt)
1910000043	130 + Feet	20 HP, 3 Phase Motor 1800 RPM (230/460 Volt),
1910000042	130 + Feet	20 HP, 3 Phase Motor 1800 RPM (575 Volt), 70' -

IDEAL

&

MAPLESIDE

TAB



Jan 2026 - All items not in Harco inventory will be subject to a potential tariff charge.

Rotary Cutters

Model	Description	Colour	Price – CDN
RC4LDIDSC	Rotary Cutter 4' Light Duty w/ Slip Clutch PTO	Gray	\$ 2,865.00
RC4LDIDSP	Rotary Cutter 4' Light Duty w/ Shear Pin PTO	Gray	\$ 2,612.00
RC5SDIDSC	Rotary Cutter 5' Standard Duty w/ Slip Clutch PTO	Gray	\$ 3,161.00
RC5SDIDSP	Rotary Cutter 5' Standard Duty w/ Shear Pin PTO	Gray	\$ 2,907.00
RC6MDID	Rotary Cutter 6' Medium Duty	Gray	\$ 4,478.00
RC6SDIDSC	Rotary Cutter 6' Standard Duty w/ Slip Clutch PTO	Gray	\$ 3,580.00
RC6SDIDSP	Rotary Cutter 6' Standard Duty w/ Shear Pin PTO	Gray	\$ 3,339.00
RC7MDID	Rotary Cutter 7' Medium Duty	Gray	\$ 6,292.00

Rotary Cutter Guards

Model	Description	Colour	Price – CDN
9000148	4' Front Rubber Guard w/ Hardware	Black	\$ 88.00
9000149	5' Front Rubber Guard w/ Hardware	Black	\$ 101.00
9000150	6' Front Rubber Guard w/ Hardware	Black	\$ 124.00
9000151	4' Rear Metal Guard w/ Hardware	Black	\$ 51.00
9000152	5' Rear Metal Guard w/ Hardware	Black	\$ 64.00
9000153	6' Rear Metal Guard w/ Hardware	Black	\$ 69.00
9000589	4' Front Chain Guard w/ Hardware	Black	\$ 179.00
9000590	4' Rear Chain Guard w/ Hardware	Black	\$ 155.00
9000591	5' Front Chain Guard w/ Hardware	Black	\$ 214.00
9000592	5' Rear Chain Guard w/ Hardware	Black	\$ 181.00
9000593	6' Front Chain Guard w/ Hardware	Black	\$ 255.00
9000594	6' Rear Chain Guard w/ Hardware	Black	\$ 195.00

Box Blades

Model	Description	Colour	Price – CDN
BB4LDID	Box Blade 4' Light Duty	Gray	\$ 1,408.00
BB5SDID	Box Blade 5' Standard Duty	Gray	\$ 1,727.00
BB6MDID	Box Blade 6' Medium Duty	Gray	\$ 2,189.00
BB6SDID	Box Blade 6' Standard Duty	Gray	\$ 1,842.00
BB7MDID	Box Blade 7' Medium Duty	Gray	\$ 2,390.00
BB8MDID	Box Blade 8' Medium Duty	Gray	\$ 2,668.00

PRICED IN CANADIAN DOLLARS

PRICES ARE FOB HARRISTON, ONT – SUBJECT TO CHANGE WITHOUT NOTICE



Jan 2026 - All items not in Harco inventory will be subject to a potential tariff charge.

Disc Harrows

Model	Description	Colour	Price – CDN
DH5LDID	Disc Harrow 5' Light Duty	Gray	\$ 2,532.00
DH6SDID	Disc Harrow 6' Standard Duty	Gray	\$ 2,642.00
DH7MDID	Disc Harrow 7' Medium Duty	Gray	\$ 3,963.00

Disc Mowers

Model	Description	Colour	Price – CDN
DM7MDID	Disc Mower 7' Medium Duty	Gray	\$15,004.00
DM8MDID	Disc Mower 8' Medium Duty	Gray	\$15,972.00
DM9MDID	Disc Mower 9' Medium Duty	Gray	\$16,698.00

Finishing Mowers

Model	Description	Colour	Price – CDN
FM5SDID	Finish Mower 5' Standard Duty	Yellow	\$ 4,216.00
FM6SDID	Finish Mower 6' Standard Duty	Yellow	\$ 4,794.00

3-Point Fertilizer Spreaders

Model	Description	Colour	Price – CDN
FSID	Fertilizer Spreader	Red	\$ 1,139.00
PFSID	Poly Fertilizer Spreader	Black/Red	\$ 1,344.00

Grader Blades

Model	Description	Colour	Price – CDN
GB4LDID	Rear Grader Blade 4' Light Duty	Gray	\$ 784.00
GB5SDID	Rear Grader Blade 5' Standard Duty	Gray	\$ 904.00
GB6MDID	Rear Grader Blade 6' Medium Duty	Gray	\$ 1,531.00
GB6SDID	Rear Grader Blade 6' Standard Duty	Gray	\$ 975.00
GB7MDID	Rear Grader Blade 7' Medium Duty	Gray	\$ 1,615.00
GB8MDID	Rear Grader Blade 8' Medium Duty	Gray	\$ 2,006.00
LG6SDID	Land Grader 6' Standard Duty	Gray	\$ 2,633.00
LG8MDID	Land Grader 8' Medium Duty	Gray	\$ 3,506.00

PRICED IN CANADIAN DOLLARS

PRICES ARE FOB HARRISTON, ONT – SUBJECT TO CHANGE WITHOUT NOTICE



Jan 2026 - All items not in Harco inventory will be subject to a potential tariff charge.

Landscape Rakes

Model	Description	Colour	Price – CDN
LR4LDID	Landscape Rake 4' Light Duty	Gray	\$ 1,124.00
LR5SDID	Landscape Rake 5' Standard Duty	Gray	\$ 1,180.00
LR6MDID	Landscape Rake 6' Medium Duty	Gray	\$ 1,724.00
LR6SDID	Landscape Rake 6' Standard Duty	Gray	\$ 1,222.00
LR7MDID	Landscape Rake 7' Medium Duty	Gray	\$ 1,921.00
LR7SDID	Landscape Rake 7' Standard Duty	Gray	\$ 1,323.00
LR8MDID	Landscape Rake 8' Medium Duty	Gray	\$ 2,348.00
LRWKID	Landscape Rake Wheel Kit	Black	\$ 561.00

Snow Pushers

Model	Description	Colour	Price – CDN
SP6BDK	Snow Pusher Back Drag Kit, 6'	Yellow	\$ 753.00
SP6SDID	Snow Pusher 6' Standard Duty	Yellow	\$ 2,427.00
SP7BDK	Snow Pusher Back Drag Kit, 7'	Yellow	\$ 1,170.00
SP7SDID	Snow Pusher 7' Standard Duty	Yellow	\$ 2,820.00
SP8BDK	Snow Pusher Back Drag Kit, 8'	Yellow	\$ 1,265.00
SP8SDID	Snow Pusher 8' Standard Duty	Yellow	\$ 2,907.00

ATV/UTV Equipment

Model	Description	Colour	Price – CDN
UDC5ID	UTV Disc/Cultipacker Combo 5'	Gray	\$ 4,993.00
UDH5ID	UTV Disc Harrow 5'	Gray	\$ 2,874.00
UFD5ID	UTV Flip Disc 5'	Gray	\$ 1,718.00
UFSID	UTV Fertilizer Spreader	Black	\$ 1,967.00
UMS10ID	UTV Manure Spreader 10 Bushel	Yellow	\$ 2,123.00
UWU2ID	UTV Wire Unroller 2" Receiver	Gray	\$ 182.00
UWUID	UTV Wire Unroller	Gray	\$ 241.00

Rotary Tillers

Model	Description	Colour	Price – CDN
RT4LDID	Rotary Tiller 4' Light Duty	Gray	\$ 4,165.00
RT5SDID	Rotary Tiller 5' Standard Duty	Gray	\$ 4,692.00
RT6SDID	Rotary Tiller 6' Standard Duty	Gray	\$ 5,253.00
RT7SDID	Rotary Tiller 7' Standard Duty	Gray	\$ 6,646.00

PRICED IN CANADIAN DOLLARS

PRICES ARE FOB HARRISTON, ONT – SUBJECT TO CHANGE WITHOUT NOTICE



Jan 2026 - All items not in Harco inventory will be subject to a potential tariff charge.

Miscellaneous Equipment

Model	Description	Colour	Price – CDN
MBSDID	Middle Buster Standard Duty	Gray	\$ 402.00
MP1SDID	Moldboard Plow One Bottom Standard Duty	Gray	\$ 1,503.00
MP2SDID	Moldboard Plow Two Bottom Standard Duty	Gray	\$ 2,394.00
PFW1242ID	Pallet Fork 1,200 lb 42"	Black	\$ 1,366.00
PFW342ID	Pallet Fork 3,000 lb 42"	Black	\$ 1,658.00
SSLDID	Sub-soiler Light Duty	Gray	\$ 344.00
SSSDID	Sub-soiler Standard Duty	Gray	\$ 441.00
TMSDID	Trailer Mover Standard Duty	Gray	\$ 357.00
WSSDID	Wire Stretcher Standard Duty	Gray	\$ 922.00
BPMID	Boom Pole Medium Duty	Gray	\$ 697.00
BPSDID	Boom Pole Standard Duty	Gray	\$ 293.00
BR52SDID	Bucket Rake 52" Standard Duty	Black	\$ 708.00
BR68SDID	Bucket Rake 68" Standard Duty	Black	\$ 768.00
CASDID	Carry All Standard Duty	Gray	\$ 305.00
FC1SDID	Field Cultivator One-Row Standard Duty	Gray	\$ 684.00
FC3SDID	Field Cultivator Three-Bar Standard Duty	Gray	\$ 1,711.00
HF1MDID	Hay Fork Single Spear Medium Duty	Gray	\$ 659.00
HF1SDID	Hay Fork Single Spear Standard Duty	Gray	\$ 412.00
HFB1ID	Hay Fork Bucket Single Spear	Black	\$ 555.00
HFF1ID	Hay Fork Front Single Spear	Black	\$ 1,082.00
TGQA254ID	Tine Grapple – Dual Cylinder	Black	\$ 3,449.00
NT5SDID	No Till Seed Drill, 9 row, 5'	Black	\$ 13,915.00
NT7SDID	No Till Seed Drill, 11 row, 7'	Black	\$ 16,262.00
DT015BL	Hydraulic Dump Trailer, 100" x 55" x 34"	Black	\$ 5,445.00
DT15ID	Utility Dump Trailer	NEW	\$4,792.00
BSQA-2BL	Double (Dual) Bale Spear	Black	\$ 1,224.00
QH1ID	Quick Hitch		\$ 363.00

PRICED IN CANADIAN DOLLARS

PRICES ARE FOB HARRISTON, ONT – SUBJECT TO CHANGE WITHOUT NOTICE



Jan 2026 - All items not in Harco inventory will be subject to a potential tariff charge.

Post Pounders

Model	Description	Colour	Price – CDN
ID100	Vibrating Head Driver	Gray	\$ 11,560.00
ID110	Vibrating Head Driver	Gray	\$ 13,276.00
TAVID	Ideal Tilt Attachment w/ Valve		\$ 5,445.00
ID205	Trailer Model w/ Electric Start	Black	\$ 28,650.00
ID210	Trailer Model w/ Hitch	Black	\$ 27,322.00
ID120K	Pilot Auger Kit		\$ 7,449.00
2000282	Auger/Bit 4.5" (Sold Separately)		\$ 1,139.00
2000281	Auger/Bit 6" (Sold Separately)		\$ 1,568.00
	Pilot Auger Factory Install		\$ 1,210.00

PRICED IN CANADIAN DOLLARS

PRICES ARE FOB HARRISTON, ONT – SUBJECT TO CHANGE WITHOUT NOTICE



Mapleside MFG INC

2026 Price List



HARCOAg
EQUIPMENT

5808 Hwy #9, Harriston, Ontario, N0G 1Z0, 519-338-2923, Fax: 519-338-2756
sales@harcoag.ca www.harcoag.ca

Rep'd in Eastern & Northern Ontario, Quebec & the Maritimes

Table of Contents

Pallet Forks.....	1
Bale Spears.....	2&3
Bale Squeezers.....	3
Bale Unrollers.....	3
Back Grill Buckets.....	4&5
Standard Profile Buckets.....	6
High Volume Buckets.....	7
Low Profile Buckets.....	8&9
High Dump Buckets.....	10
3 Point Hitch Dump Boxes.....	11
3 Point Hitch Weight Boxes.....	11
3 Point Hitch Box Blades.....	12
3 Point Hitch Grader Blades.....	12
Land Planes.....	13
Land Levelers.....	14
Heavy Duty Brush Grapple.....	15
Log Grapple Forks.....	15
Hydraulic Tree Puller Stump Bucket.....	16
Manure Forks.....	17
Rock Buckets.....	18
Snow Pushers.....	19
Compact Snow Pushers.....	20
Hydraulic Snow Blades.....	21
Rotary Cutters.....	22
Lawn Rollers.....	23
Boom Poles.....	23
MT Attachments.....	24
Pins, Adapters, & Accessories.....	25&26



Prices are FOB Creemore, Ont - Subject to change without notice

Pallet Forks

1200 Pound Cap. Pallet Forks

<u>Product ID</u>	<u>Description</u>	<u>Gross Weight</u>	<u>List Price</u>
12JDQAPF	1200lb PALLET FORK JD440/540 Q-TACH FRAME ONLY	200 lbs	\$410.00
12JDQAPF-42	1200lb PALLET FORK JD440/540 Q-TACH w/42" TINES	295 lbs	\$660.00
12JDQAPF-48	1200lb PALLET FORK JD440/540 Q-TACH w/48" TINES	305 lbs	\$680.00
12SQAPF	1200lb PALLET FORK SS Q-TACH FRAME ONLY	200 lbs	\$410.00
12SQAPF-42	1200lb PALLET FORK SS Q-TACH w/42" TINES	295 lbs	\$660.00
12SQAPF-48	1200lb PALLET FORK SS Q-TACH w/48" TINES	305 lbs	\$680.00

2000 Pound Cap. Pallet Forks

20JDQAPF	2000lb PALLET FORK JD440/540 Q-TACH FRAME ONLY	230 lbs	\$475.00
20JDQAPF-42	2000lb PALLET FORK JD440/540 Q-TACH w/42" TINES	325 lbs	\$715.00
20JDQAPF-48	2000lb PALLET FORK JD440/540 Q-TACH w/48" TINES	335 lbs	\$725.00
20SQAPF	2000lb PALLET FORK SS Q-TACH FRAME ONLY	230 lbs	\$475.00
20SQAPF-42	2000lb PALLET FORK SS Q-TACH w/42" TINES	325 lbs	\$715.00
20SQAPF-48	2000lb PALLET FORK SS Q-TACH w/48" TINES	335 lbs	\$725.00
20EQAPF	2000lb PALLET FORK EURO Q-TACH FRAME ONLY	230 lbs	\$475.00
20EQAPF-42	2000lb PALLET FORK EURO Q-TACH w/42" TINES	325 lbs	\$715.00
20EQAPF-48	2000lb PALLET FORK EURO Q-TACH w/48" TINES	335 lbs	\$725.00

5500 Pound Cap. Pallet Forks

55JDQAPF	5500lb PALLET FORK JD 640 Q-TACH FRAME ONLY	306 lbs	\$785.00
55JDQAPF-42	5500lb PALLET FORK JD640 Q-TACH w/42" TINES	400 lbs	\$1,060.00
55JDQAPF-48	5500lb PALLET FORK JD640 Q-TACH w/48" TINES	410 lbs	\$1,090.00
55JDQAPF-54	5500lb PALLET FORK JD640 Q-TACH w/ 54" TINES	420 lbs	\$1,220.00
55SQAPF	5500lb PALLET FORK SS Q-TACH FRAME ONLY	296 lbs	\$785.00
55SQAPF-42	5500lb PALLET FORK SS Q-TACH w/42" TINES	390 lbs	\$1,060.00
55SQAPF-48	5500lb PALLET FORK SS Q-TACH w/48" TINES	400 lbs	\$1,090.00
55SQAPF-54	5500lb PALLET FORK SS Q-TACH w/ 54" TINES	410 lbs	\$1,220.00
55EQAPF	5500lb PALLET FORK EURO Q-TACH FRAME ONLY	296 lbs	\$785.00
55EQAPF-42	5500lb PALLET FORK EURO Q-TACH w/42" TINES	390 lbs	\$1,060.00
55EQAPF-48	5500lb PALLET FORK EURO Q-TACH w/48" TINES	400 lbs	\$1,090.00
55EQAPF-54	5500lb PALLET FORK EURO Q-TACH w/ 54" TINES	410 lbs	\$1,220.00



5500 LBS



2000 LBS



1200 LBS



ALL PALLET FORKS COME WITH CLASS 2 TINES > 4" WIDE, 1.5" THICK

ALL PALLET FORK FRAMES HAVE 50" WIDE CARRIAGE

HARCOAg
EQUIPMENT

Bale Spears

Single Prong Bale Spears

<i>Product ID</i>	<i>Description</i>	<i>Gross Weight</i>	<i>List Price</i>
SQASPBS	SINGLE PRONG BALE SPEAR SS Q-TACH FRAME ONLY		\$520.00
SQASPBS-39	SINGLE PRONG BALE SPEAR SS Q-TACH W/39" TINE		\$670.00
SQASPBS-49	SINGLE PRONG BALE SPEAR SS Q-TACH W/49" TINE		\$705.00
JDQASPBS	SINGLE PRONG BALE SPEAR JD Q-TACH FRAME ONLY		\$520.00
JDQASPBS-39	SINGLE PRONG BALE SPEAR JD Q-TACH W/39" TINE		\$670.00
JDQASPBS-49	SINGLE PRONG BALE SPEAR JD Q-TACH W/49" TINE		\$705.00
EQASPBS	SINGLE PRONG BALE SPEAR EURO Q-TACH FRAME ONLY		\$520.00
EQASPBS-39	SINGLE PRONG BALE SPEAR EURO Q-TACH 39" TINE		\$670.00
EQASPBS-49	SINGLE PRONG BALE SPEAR EURO Q-TACH 49" TINE		\$705.00

Double Prong Bale Spears

<i>Product ID</i>	<i>Description</i>	<i>Gross Weight</i>	<i>List Price</i>
SQABSHD	H.D BALE SPEAR SS Q-TACH FRAME ONLY	193 lbs	\$525.00
SQABSHD-39	H.D BALE SPEAR SS Q-TACH w/39" TINE		\$805.00
SQABSHD-49	H.D BALE SPEAR SS Q-TACH w/49" TINE	230 lbs	\$815.00
JDQABS	BALE SPEAR JD440/540 Q-TACH FRAME ONLY		\$550.00
JDQABS-39	BALE SPEAR JD440/540 Q-TACH 39" TINE		\$805.00
JDQABS-49	BALE SPEAR JD440/540 Q-TACH 49" TINE		\$815.00
EQABS	H.D BALE SPEAR EURO Q-TACH FRAME ONLY	198 lbs	\$780.00
EQABS-39	H.D BALE SPEAR EURO Q-TACH 39" TINE		\$910.00
EQABS-49	H.D BALE SPEAR EURO Q-TACH 49" TINE	235 lbs	\$925.00

DPT	2 PRONG SLIDE IN BALE SPEAR TUBE/3x3/SET		\$140.00
-----	------------------------------------------	--	----------



Single Prong Bale Spear



Double Prong Bale Spear

BALE SPEARS DO NOT COME WITH VERTICAL UPRIGHT POSTES



Bale Spears

Triple Prong Bale Spears

<i>Product ID</i>	<i>Description</i>	<i>Gross Weight</i>	<i>List Price</i>
SQABSTP	3 PRONG BALE SPEAR SS Q-TACH FRAME ONLY	243 lbs	\$770.00
SQABSTP-39	3 PRONG BALE SPEAR SS Q-TACH 39" TINES		\$1,190.00
SQABSTP-49	3 PRONG BALE SPEAR SS Q-TACH 49" TINES	283 lbs	\$1,290.00
EQABSTP	3 PRONG BALE SPEAR EURO Q-TACH FRAME ONLY	248 lbs	\$770.00
EQABSTP-39	3 PRONG BALE SPEAR EURO Q-TACH 39" TINES		\$1,190.00
EQABSTP-49	3 PRONG BALE SPEAR EURO Q-TACH 49" TINES	288 lbs	\$1,290.00
3PBSBR	BACK RACK FOR 3 PRONG BALE SPEARS		\$710.00

Bale Squeezers

<i>Product ID</i>	<i>Description</i>	<i>Gross Weight</i>	<i>List Price</i>
BSSQA	BALE SQUEEZER SKID STEER Q-TACH	580 lbs	\$2,290.00
BSEQA	BALE SQUEEZER EURO Q-TACH	580 lbs	\$2,290.00

3 Point Hitch Round Bale Unroller

<i>Product ID</i>	<i>Description</i>	<i>Gross Weight</i>	<i>List Price</i>
RBU3PH	3 POINT HITCH ROUND BALE UN-ROLLER	335 lbs	\$2,565.00



3 Prong Bale Spear



3 Prong Bale Spear Back Rack



Bale Squeezer



Round Bale Unroller



Buckets

Skid Steer Hookup Back Grill Buckets

<i>Product ID</i>	<i>Description</i>	<i>Gross Weight</i>	<i>List Price</i>
BGB72SQA	BACK GRILL 72" SS Q-TACH BUCKET	585 lbs	\$1,830.00
BGB72SQA-BOCE	BACK GRILL 72" SS Q-TACH BUCKET W/ BOLT ON CUTTING EDGE	670 lbs	\$2,020.00
BGB72SQA-TEETH	BACK GRILL 72" SS Q-TACH BUCKET W/ TEETH	647 lbs	\$2,005.00
BGB78SQA	BACK GRILL 78" SS Q-TACH BUCKET	615 lbs	\$1,920.00
BGB78SQA-BOCE	BACK GRILL 78" SS Q-TACH BUCKET W/ BOLT ON CUTTING EDGE	707 lbs	\$2,130.00
BGB78SQA-TEETH	BACK GRILL 78" SS Q-TACH BUCKET W/ TEETH	677 lbs	\$2,075.00
BGB81SQA	BACK GRILL 81" SS Q-TACH BUCKET	625 lbs	\$1,930.00
BGB81SQA-TEETH	BACK GRILL 81" SS Q-TACH BUCKET W/ TEETH	680 lbs	\$2,120.00
BGB84SQA	BACK GRILL 84" SS Q-TACH BUCKET	645 lbs	\$1,990.00
BGB84SQA-BOCE	BACK GRILL 84" SS Q-TACH BUCKET W/ BOLT ON CUTTING EDGE	744 lbs	\$2,215.00
BGB84SQA-TEETH	BACK GRILL 84" SS Q-TACH BUCKET W/ TEETH	714 lbs	\$2,195.00
BGB90SQA	BACK GRILL 90" SS Q-TACH BUCKET	675 lbs	\$2,080.00
BGB90SQA-BOCE	BACK GRILL 90" SS Q-TACH BUCKET W/ BOLT ON CUTTING EDGE	781 lbs	\$2,320.00
BGB90SQA-TEETH	BACK GRILL 90" SS Q-TACH BUCKET W/ TEETH	750 lbs	\$2,465.00
BGB96SQA	BACK GRILL 96" SS Q-TACH BUCKET	705 lbs	\$2,220.00
BGB96SQA-BOCE	BACK GRILL 96" SS Q-TACH BUCKET W/ BOLT ON CUTTING EDGE	818 lbs	\$2,480.00
BGB96SQA-TEETH	BACK GRILL 96" SS Q-TACH BUCKET W/ TEETH	780 lbs	\$2,555.00
HDBGB78SQA	HD BACK GRILL 78" SS Q-TACH BUCKET	856 lbs	\$2,420.00
HDBGB78SQA-BOCE	HD B/G 78" SS Q-TACH BUCKET W/ BOLT ON CUTTING EDGE	948 lbs	\$2,630.00
HDBGB78SQA-TEETH	HD BACK GRILL 78" SS Q-TACH BUCKET W/ TEETH	918 lbs	\$2,835.00
HDBGB84SQA	HD BACK GRILL 84" SS Q-TACH BUCKET	940 lbs	\$2,545.00
HDBGB84SQA-BOCE	HD B/G 84" SS Q-TACH BUCKET W/ BOLT ON CUTTING EDGE	1040 lbs	\$2,770.00
HDBGB84SQA-TEETH	HD BACK GRILL 84" SS Q-TACH BUCKET W/ TEETH	1010 lbs	\$3,000.00



Buckets

Euro/Alo Hookup Back Grill Buckets

<u>Product ID</u>	<u>Description</u>	<u>Gross Weight</u>	<u>List Price</u>
BGB72EQA	BACK GRILL 72" EURO Q-TACH BUCKET	590 lbs	\$1,830.00
BGB72EQA-BOCE	B/G 72" EURO Q-TACH BUCKET W/ BOLT ON CUTTING EDGE	675 lbs	\$2,020.00
BGB72EQA-TEETH	BACK GRILL 72" EURO Q-TACH W/ TEETH	652 lbs	\$2,005.00
BGB78EQA	BACK GRILL 78" EURO Q-TACH BUCKET	620 lbs	\$1,920.00
BGB78EQA-BOCE	B/G 78" EURO Q-TACH BUCKET W/ BOLT ON CUTTING EDGE	712 lbs	\$2,130.00
BGB78EQA-TEETH	BACK GRILL 78" EURO Q-TACH W/ TEETH	682 lbs	\$2,075.00
BGB84EQA	BACK GRILL 84" EURO Q-TACH BUCKET	650 lbs	\$1,990.00
BGB84EQA-BOCE	B/G 84" EURO Q-TACH BUCKET W/ BOLT ON CUTTING EDGE	749 lbs	\$2,215.00
BGB84EQA-TEETH	BACK GRILL 84" EURO Q-TACH W/ TEETH	719 lbs	\$2,195.00
BGB90EQA	BACK GRILL 90" EURO Q-TACH BUCKET	680 lbs	\$2,080.00
BGB90EQA-BOCE	B/G 90" EURO Q-TACH BUCKET W/ BOLT ON CUTTING EDGE	786 lbs	\$2,320.00
BGB90EQA-TEETH	BACK GRILL 90" EURO Q-TACH W/ TEETH	755 bs	\$2,465.00
BGB96EQA	BACK GRILL 96" EURO Q-TACH BUCKET	710 lbs	\$2,220.00
BGB96EQA-BOCE	B/G 96" EURO Q-TACH BUCKET W/ BOLT ON CUTTING EDGE	823 lbs	\$2,480.00
BGB96EQA-TEETH	BACK GRILL 96" EURO Q-TACH BUCKET W/ TEETH	785 lbs	\$2,555.00



REG. DUTY BACK GRILL BUCKETS

>COME WITH 5/8" X 6" WELDED ON CUTTING EDGE

>3/16 MATERIAL THROUGHOUT

>BOTTOM RUNNERS

>ALL BUCKETS ARE COMPATABLE WITH BOLT ON CUTTING EDGE

>40" DEEP BY 34" HIGH FROM BOTTOM TO TOP OF GRILL

HEAVY DUTY BACK GRILL BUCKETS

>COME WITH 3/4" X 6" WELDED ON CUTTING EDGE

>1/4" MATERIAL THROUGHOUT

>AR400 BOTTOM RUNNERS AS WELL AS SIDE CUTTERS

>ALL BUCKETS ARE COMPATABLE WITH BOLT ON CUTTING EDGE

>40" DEEP BY 34" HIGH FROM BOTTOM TO TOP OF GRILL



Buckets

Skid Steer Hookup Standard Profile Buckets

<u>Product ID</u>	<u>Description</u>	<u>Gross Weight</u>	<u>List Price</u>
SPB72SQA	STANDARD PROFILE 72" SS Q-TACH BUCKET	645 lbs	\$1,785.00
SPB72SQA-BOCE	S/P 72" SS Q-TACH BUCKET W/ BOLT ON CUTTING EDGE	730 lbs	\$1,975.00
SPB72SQA-TEETH	STANDARD PROFILE 72" SS Q-TACH BUCKET W/ TEETH	705 lbs	\$2,085.00
SPB78SQA	STANDARD PROFILE 78" SS Q-TACH BUCKET	670 lbs	\$1,820.00
SPB78SQA-BOCE	S/P 78" SS Q-TACH BUCKET W/ BOLT ON CUTTING EDGE	762 lbs	\$2,030.00
SPB78SQA-TEETH	STANDARD PROFILE 78" SS Q-TACH BUCKET W/ TEETH	730 lbs	\$2,120.00
SPB84SQA	STANDARD PROFILE 84" SS Q-TACH BUCKET	715 lbs	\$1,885.00
SPB84SQA-BOCE	S/P 84" SS Q-TACH BUCKET W/ BOLT ON CUTTING EDGE	814 lbs	\$2,110.00
SPB84SQA-TEETH	STANDARD PROFILE 84" SS Q-TACH BUCKET W/ TEETH	775 lbs	\$2,185.00
SPB90SQA	STANDARD PROFILE 90" SS Q-TACH BUCKET	750 lbs	\$2,050.00
SPB90SQA-BOCE	S/P 90" SS Q-TACH BUCKET W/ BOLT ON CUTTING EDGE	856 lbs	\$2,290.00
SPB90SQA-TEETH	STANDARD PROFILE 90" SS Q-TACH BUCKET W/ TEETH	810 lbs	\$2,350.00
SPB96SQA	STANDARD PROFILE 96" SS Q-TACH BUCKET	790 lbs	\$2,200.00
SPB96SQA-BOCE	S/P 96" SS Q-TACH BUCKET W/ BOLT ON CUTTING EDGE	903 lbs	\$2,460.00
SPB96SQA-TEETH	STANDARD PROFILE 96" SS Q-TACH BUCKET W/ TEETH	850 lbs	\$2,500.00

Euro/Alo Hookup Standard Profile Buckets

<u>Product ID</u>	<u>Description</u>	<u>Gross Weight</u>	<u>List Price</u>
SPB72EQA	STANDARD PROFILE 72" EURO Q-TACH BUCKET	650 lbs	\$1,785.00
SPB72EQA-BOCE	S/P 72" EURO Q-TACH BUCKET W/ BOLT ON CUTTING EDGE	735 lbs	\$1,975.00
SPB72EQA-TEETH	STANDARD PROFILE 72" EURO Q-TACH BUCKET W/ TEETH	710 lbs	\$2,085.00
SPB78EQA	STANDARD PROFILE 78" EURO Q-TACH BUCKET	675 lbs	\$1,820.00
SPB78EQA-BOCE	S/P 78" EURO Q-TACH BUCKET W/ BOLT ON CUTTING EDGE	767 lbs	\$2,030.00
SPB78EQA-TEETH	STANDARD PROFILE 78" EURO Q-TACH BUCKET W/ TEETH	735 lbs	\$2,120.00
SPB84EQA	STANDARD PROFILE 84" EURO Q-TACH BUCKET	720 lbs	\$1,885.00
SPB84EQA-BOCE	S/P 84" EURO Q-TACH BUCKET W/ BOLT ON CUTTING EDGE	819 lbs	\$2,110.00
SPB84EQA-TEETH	STANDARD PROFILE 84" EURO Q-TACH BUCKET W/ TEETH	780 lbs	\$2,185.00
SPB90EQA	STANDARD PROFILE 90" EURO Q-TACH BUCKET	755 lbs	\$2,050.00
SPB90EQA-BOCE	S/P 90" EURO Q-TACH BUCKET W/ BOLT ON CUTTING EDGE	861 lbs	\$2,290.00
SPB90EQA-TEETH	STANDARD PROFILE 90" EURO Q-TACH BUCKET W/ TEETH	815 lbs	\$2,350.00
SPB96EQA	STANDARD PROFILE 96" EURO Q-TACH BUCKET	795 lbs	\$2,200.00
SPB96EQA-BOCE	S/P 96" EURO Q-TACH BUCKET W/ BOLT ON CUTTING EDGE	908 lbs	\$2,460.00
SPB96EQA-TEETH	STANDARD PROFILE 96" EURO Q-TACH BUCKET W/ TEETH	855 lbs	\$2,500.00

>3/16 MATERIAL THROUGHOUT

>COME WITH 5/8" X 6" WELDED ON CUTTING EDGE

>BOTTOM RUNNERS

>ALL BUCKETS ARE COMPATIBLE WITH BOLT ON CUTTING EDGE

>39" DEEP BY 30" HIGH



Buckets

Skid Steer Hookup High Volume Buckets

<i>Product ID</i>	<i>Description</i>	<i>Gross Weight</i>	<i>List Price</i>
HVB72SQA	HIGH VOLUME 72" SS Q-TACH BUCKET	660 lbs	\$1,835.00
HVB72SQA-BOCE	H/V 72" SS Q-TACH BUCKET W/ BOLT ON CUTTING EDGE	745 lbs	\$2,025.00
HVB78SQA	HIGH VOLUME 78" SS Q-TACH BUCKET	690 lbs	\$1,905.00
HVB78SQA-BOCE	H/V 78" SS Q-TACH BUCKET W/ BOLT ON CUTTING EDGE	782 lbs	\$2,115.00
HVB84SQA	HIGH VOLUME 84" SS Q-TACH BUCKET	720 lbs	\$1,995.00
HVB84SQA-BOCE	H/V 84" SS Q-TACH BUCKET W/ BOLT ON CUTTING EDGE	819 lbs	\$2,220.00
HVB90SQA	HIGH VOLUME 90" SS Q-TACH BUCKET	750 lbs	\$2,140.00
HVB90SQA-BOCE	H/V 90" SS Q-TACH BUCKET W/ BOLT ON CUTTING EDGE	856 lbs	\$2,380.00
HVB96SQA	HIGH VOLUME 96" SS Q-TACH BUCKET	780 lbs	\$2,225.00
HVB96SQA-BOCE	H/V 96" SS Q-TACH BUCKET W/ BOLT ON CUTTING EDGE	893 lbs	\$2,485.00
HVB102SQA	HIGH VOLUME 102" SS Q-TACH BUCKET	800 lbs	\$2,310.00
HVB102SQA-BOCE	H/V 102" SS Q-TACH BUCKET W/ BOLT ON CUTTING EDGE	919 lbs	\$2,590.00
HVB108SQA	HIGH VOLUME 108" SS Q-TACH BUCKET	820 lbs	\$2,380.00
HVB108SQA-BOCE	H/V 108" SS Q-TACH BUCKET W/ BOLT ON CUTTING EDGE	946 lbs	\$2,680.00
HVB120SQA	HIGH VOLUME 120" SS Q-TACH BUCKET		\$2,540.00
HVB144SQA	HIGH VOLUME 144" SS Q-TACH BUCKET	1310 lbs	\$3,240.00

Euro/Alo Hookup High Volume Buckets

<i>Product ID</i>	<i>Description</i>	<i>Gross Weight</i>	<i>List Price</i>
HVB72EQA	HIGH VOLUME 72" EURO Q-TACH BUCKET	665 lbs	\$1,835.00
HVB72EQA-BOCE	H/V 72" EURO Q-TACH BUCKET W/ BOLT ON CUTTING EDGE	750 lbs	\$2,025.00
HVB78EQA	HIGH VOLUME 78" EURO Q-TACH BUCKET	695 lbs	\$1,905.00
HVB78EQA-BOCE	H/V 78" EURO Q-TACH BUCKET W/ BOLT ON CUTTING EDGE	787 lbs	\$2,115.00
HVB84EQA	HIGH VOLUME 84" EURO Q-TACH BUCKET	725 lbs	\$1,995.00
HVB84EQA-BOCE	H/V 84" EURO Q-TACH BUCKET W/ BOLT ON CUTTING EDGE	824 lbs	\$2,220.00
HVB90EQA	HIGH VOLUME 90" EURO Q-TACH BUCKET	755 lbs	\$2,140.00
HVB90EQA-BOCE	H/V 90" EURO Q-TACH BUCKET W/ BOLT ON CUTTING EDGE	861 lbs	\$2,380.00
HVB96EQA	HIGH VOLUME 96" EURO Q-TACH BUCKET	785 lbs	\$2,225.00
HVB96EQA-BOCE	H/V 96" EURO Q-TACH BUCKET W/ BOLT ON CUTTING EDGE	898 lbs	\$2,485.00
HVB102EQA	HIGH VOLUME 102" EURO Q-TACH BUCKET	805 lbs	\$2,310.00
HVB102EQA-BOCE	H/V 102" EURO Q-TACH BUCKET W/ BOLT ON CUTTING EDGE	924 lbs	\$2,590.00
HVB108EQA	HIGH VOLUME 108" EURO Q-TACH BUCKET	825 lbs	\$2,380.00
HVB108EQA-BOCE	H/V 108" EURO Q-TACH BUCKET W/ BOLT ON CUTTING EDGE	951 lbs	\$2,680.00
HVB120EQA	HIGH VOLUME 120" EURO Q-TACH BUCKET		\$2,535.00

>3/16 MATERIAL THROUGHOUT

>COME WITH 5/8" X 6" WELDED ON CUTTING EDGE

>BOTTOM RUNNERS

>ALL BUCKETS ARE COMPATIBLE WITH BOLT ON CUTTING EDGE

>48" DEEP BY 35" HIGH



Buckets

Skid Steer Hookup Low Profile Buckets

<i>Product ID</i>	<i>Description</i>	<i>Gross Weight</i>	<i>List Price</i>
66LPBSQA	LOW PROFILE 66" SKID STEER Q-TACH BUCKET	385 lbs	\$1,125.00
66LPBSQA-BOCE	L/P 66" SKID STEER Q-TACH BUCKET W/ BOLT ON CUTTING EDGE	463 lbs	\$1,305.00
66LPBSQA-TEETH	LOW PROFILE 66" SKID STEER Q-TACH BUCKET W/ TEETH	440 lbs	\$1,485.00
72LPBSQA	LOW PROFILE 72" SKID STEER Q-TACH BUCKET	415 lbs	\$1,180.00
72LPBSQA-BOCE	L/P 72" SKID STEER Q-TACH BUCKET W/ BOLT ON CUTTING EDGE	500 lbs	\$1,370.00
72LPBSQA-TEETH	LOW PROFILE 72" SKID STEER Q-TACH BUCKET W/ TEETH	477 lbs	\$1,485.00
78LPBSQA	LOW PROFILE 78" SKID STEER Q-TACH BUCKET	445 lbs	\$1,250.00
78LPBSQA-BOCE	L/P 78" SKID STEER Q-TACH BUCKET W/ BOLT ON CUTTING EDGE	537 lbs	\$1,460.00
78LPBSQA-TEETH	LOW PROFILE 78" SKID STEER Q-TACH BUCKET W/ TEETH	507 lbs	\$1,560.00
84LPBSQA	LOW PROFILE 84" SKID STEER Q-TACH BUCKET	475 lbs	\$1,295.00
84LPBSQA-BOCE	L/P 84" SKID STEER Q-TACH BUCKET W/ BOLT ON CUTTING EDGE	574 lbs	\$1,520.00
84LPBSQA-TEETH	LOW PROFILE 84" SKID STEER Q-TACH BUCKET W/ TEETH	544 lbs	\$1,755.00
90LPBSQA	LOW PROFILE 90" SKID STEER Q-TACH BUCKET	505 lbs	\$1,340.00
90LPBSQA-BOCE	L/P 90" SKID STEER Q-TACH BUCKET W/ BOLT ON CUTTING EDGE	611 lbs	\$1,580.00
90LPBSQA-TEETH	LOW PROFILE 90" SKID STEER Q-TACH BUCKET W/ TEETH	580 lbs	\$1,840.00
96LPBSQA	LOW PROFILE 96" SKID STEER Q-TACH BUCKET	535 lbs	\$1,385.00
96LPBSQA-BOCE	L/P 96" SKID STEER Q-TACH BUCKET W/ BOLT ON CUTTING EDGE	648 lbs	\$1,645.00
96LPBSQA-TEETH	LOW PROFILE 96" SKID STEER Q-TACH BUCKET W/ TEETH	610 lbs	\$1,770.00

Euro/Alo Hookup Low Profile Buckets

<i>Product ID</i>	<i>Description</i>	<i>Gross Weight</i>	<i>List Price</i>
66LPBEQA	LOW PROFILE 66" EURO Q-TACH BUCKET	390 lbs	\$1,125.00
66LPBEQA-BOCE	L/P 66" EURO Q-TACH BUCKET W/ BOLT ON CUTTING EDGE	468 lbs	\$1,305.00
66LPBEQA-TEETH	LOW PROFILE 66" EURO Q-TACH BUCKET W/ TEETH	445 lbs	\$1,485.00
72LPBEQA	LOW PROFILE 72" EURO Q-TACH BUCKET	420 lbs	\$1,180.00
72LPBEQA-BOCE	L/P 72" EURO Q-TACH BUCKET W/ BOLT ON CUTTING EDGE	505 lbs	\$1,370.00
72LPBEQA-TEETH	LOW PROFILE 72" EURO Q-TACH BUCKET W/ TEETH	482 lbs	\$1,485.00
78LPBEQA	LOW PROFILE 78" EURO Q-TACH BUCKET	450 lbs	\$1,250.00
78LPBEQA-BOCE	L/P 78" EURO Q-TACH BUCKET W/ BOLT ON CUTTING EDGE	442 lbs	\$1,460.00
78LPBEQA-TEETH	LOW PROFILE 78" EURO Q-TACH BUCKET W/ TEETH	512 lbs	\$1,560.00
84LPBEQA	LOW PROFILE 84" EURO Q-TACH BUCKET	480 lbs	\$1,295.00
84LPBEQA-BOCE	L/P 84" EURO Q-TACH BUCKET W/ BOLT ON CUTTING EDGE	579 lbs	\$1,520.00
84LPBEQA-TEETH	LOW PROFILE 84" EURO Q-TACH BUCKET W/ TEETH	549 lbs	\$1,755.00
90LPBEQA	LOW PROFILE 90" EURO Q-TACH BUCKET	510 lbs	\$1,340.00
90LPBEQA-BOCE	L/P 90" EURO Q-TACH BUCKET W/ BOLT ON CUTTING EDGE	616 lbs	\$1,385.00
90LPBEQA-TEETH	LOW PROFILE 90" EURO Q-TACH BUCKET W/ TEETH	585 lbs	\$1,840.00
96LPBEQA	LOW PROFILE 96" EURO Q-TACH BUCKET	540 lbs	\$1,385.00
96LPBEQA-BOCE	L/P 96" EURO Q-TACH BUCKET W/ BOLT ON CUTTING EDGE	653 lbs	\$1,645.00
96LPBEQA-TEETH	LOW PROFILE 96" EURO Q-TACH BUCKET W/ TEETH	615 lbs	\$1,770.00



Buckets

John Deer 440/540 Hookup Low Profile Buckets

<i>Product ID</i>	<i>Description</i>	<i>Gross Weight</i>	<i>List Price</i>
66LPBJDQA	LOW PROFILE 66" JD440/540 Q-TACH BUCKET	390 lbs	\$1,125.00
66LPBJDQA-BOCE	L/P 66" JD440/540 Q-TACH BUCKET W/ BOLT ON CUTTING EDGE	468 lbs	\$1,305.00
66LPBJDQA-TEETH	LOW PROFILE 66" JD440/540 Q-TACH BUCKET W/ TEETH	445 lbs	\$1,485.00
72LPBJDQA	LOW PROFILE 72" JD440/540 Q-TACH BUCKET	420 lbs	\$1,180.00
72LPBJDQA-BOCE	L/P 72" JD440/540 Q-TACH BUCKET W/ BOLT ON CUTTING EDGE	505 lbs	\$1,370.00
72LPBJDQA-TEETH	LOW PROFILE 72" JD440/540 Q-TACH BUCKET W/ TEETH	482 lbs	\$1,485.00
78LPBJDQA	LOW PROFILE 78" JD440/540 Q-TACH BUCKET	450 lbs	\$1,250.00
78LPBJDQA-BOCE	L/P 78" JD440/540 Q-TACH BUCKET W/ BOLT ON CUTTING EDGE	442 lbs	\$1,460.00
78LPBJDQA-TEETH	LOW PROFILE 78" JD440/540 Q-TACH BUCKET W/ TEETH	512 lbs	\$1,560.00
84LPBJDQA	LOW PROFILE 84" JD440/540 Q-TACH BUCKET	480 lbs	\$1,295.00
84LPBJDQA-BOCE	L/P 84" JD440/540 Q-TACH BUCKET W/ BOLT ON CUTTING EDGE	579 lbs	\$1,520.00
84LPBJDQA-TEETH	LOW PROFILE 84" JD440/540 Q-TACH BUCKET W/ TEETH	549 lbs	\$1,755.00
90LPBJDQA	LOW PROFILE 90" JD440/540 Q-TACH BUCKET	510 lbs	\$1,340.00
90LPBJDQA-BOCE	L/P 90" JD440/540 Q-TACH BUCKET W/ BOLT ON CUTTING EDGE	616 lbs	\$1,345.00
90LPBJDQA-TEETH	LOW PROFILE 90" JD440/540 Q-TACH BUCKET W/ TEETH	585 lbs	\$1,840.00
96LPBJDQA	LOW PROFILE 96" JD440/540 Q-TACH BUCKET	540 lbs	\$1,385.00
96LPBJDQA-BOCE	L/P 96" JD440/540 Q-TACH BUCKET W/ BOLT ON CUTTING EDGE	653 lbs	\$1,645.00
96LPBJDQA-TEETH	LOW PROFILE 96" JD440/540 Q-TACH BUCKET W/ TEETH	615 lbs	\$1,770.00

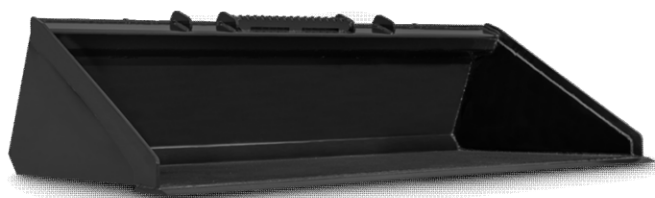

>3/16 MATERIAL THROUGHOUT

>COME WITH 5/8" X 6" WELDED ON CUTTING EDGE

>BOTTOM RUNNERS

>ALL BUCKETS ARE COMPATIBLE WITH BOLT ON CUTTING EDGE

>34" DEEP BY 19" HIGH



Dump Buckets

Regular Capacity High Dump Buckets

<i>Product ID</i>	<i>Description</i>	<i>Gross Weight</i>	<i>List Price</i>
HDB86SQA	HIGH DUMP 86" SS Q-TACH BUCKET	987 lbs	\$4,565.00
HDB92SQA	HIGH DUMP 92" SS Q-TACH BUCKET		\$4,730.00
HDB98SQA	HIGH DUMP 98" SS Q-TACH BUCKET		\$4,880.00
HDB104SQA	HIGH DUMP 104" SS Q-TACH BUCKET		\$5,030.00
HDB110SQA	HIGH DUMP 110" SS Q-TACH BUCKET		\$5,190.00

High Volume High Dump Buckets

<i>Product ID</i>	<i>Description</i>	<i>Gross Weight</i>	<i>List Price</i>
HVHDB80SQA	HIGH VOLUME HIGH DUMP BUCKET 80" SS Q-TACH		\$5,400.00
HVHDB84SQA	HIGH VOLUME HIGH DUMP BUCKET 84" SS Q-TACH		\$5,450.00
HVHDB86SQA	HIGH VOLUME HIGH DUMP BUCKET 86" SS Q-TACH	1145 lbs	\$5,500.00
HVHDB96SQA	HIGH VOLUME HIGH DUMP BUCKET 96" SS Q-TACH	1326 lbs	\$5,545.00



Normal Capacity High Dump Bucket



High Volume High Dump Bucket

3PH Dump and Weight Boxes

3 Point Hitch Dump Boxes

<i>Product ID</i>	<i>Description</i>	<i>Gross Weight</i>	<i>List Price</i>
3X3DB3PH	3' X 3' DUMP BOX 3PH 10 CUBIC FEET		\$400.00
4X4DB3PH	4' X 4' DUMP BOX 3PH 30 CUBIC FEET		\$860.00



3 Point Hitch Dump Box

3 Point Hitch Weight Boxes

<i>Product ID</i>	<i>Description</i>	<i>Gross Weight</i>	<i>List Price</i>
3PHWB-SM-R	SMALL 3PH WEIGHT BOX CAT 1 - RED		\$489.00
3PHWB-SM-JD	SMALL WEIGHT BOX CAT 1 - JD GREEN		\$489.00
3PHWB-SM-O	SMALL 3PH WEIGHT BOX CAT 1 - ORANGE		\$489.00
3PHWB-LG-R	BIG 3PH WEIGHT BOX CAT 2 - RED		\$549.00
3PHWB-LG-JD	BIG 3PH WEIGHT BOX CAT 2 - JD GREEN		\$549.00
3PHWB-LG-O	BIG 3PH WEIGHT BOX CAT 2 - ORANGE		\$549.00

Blades

3 Point Hitch Box Blades

<u>Product ID</u>	<u>Description</u>	<u>Gross Weight</u>	<u>List Price</u>
4BB3PH	4 FT BOX BLADE 3 POINT HITCH - 3 RIPPERS	360 lbs	\$925.00
5BB3PH	5 FT BOX BLADE 3 POINT HITCH - 4 RIPPERS	420 Lbs	\$1,080.00
6BB3PH	6 FT BOX BLADE 3 POINT HITCH - 5 RIPPERS	520 lbs	\$1,205.00
7BB3PH	7 FT BOX BLADE 3 POINT HITCH - 6 RIPPERS	593 lbs	\$1,345.00
8BB3PH	8 FT BOX BLADE 3 POINT HITCH - 7 RIPPERS	655 lbs	\$1,470.00

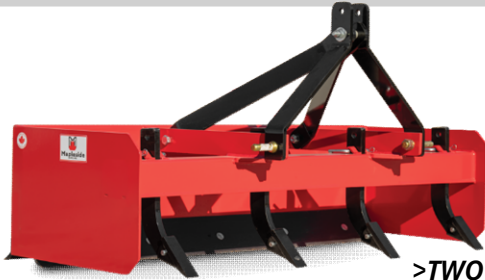

>TWO REVERSABLE CUTTING EDGES

>CUTTING EDGE ON THE BACK FOR PUSHING APPLICATIONS

>4FT AND 5FT HAVE 5/16" THICK SIDES

>6FT, 7FT, AND 8FT HAVE 1/2" THICK SIDES

>3/16" MAIN BODY MATERIALS

3 Point Hitch Grader Blades

<u>Product ID</u>	<u>Description</u>	<u>Gross Weight</u>	<u>List Price</u>
3PHGB-4	3 POINT HITCH GRADER BLADE 4 FT	177 lbs	\$810.00
3PHGB-5	3 POINT HITCH GRADER BLADE 5 FT	204 lbs	\$880.00
3PHGB-6	3 POINT HITCH GRADER BLADE 6 FT	225 lbs	\$935.00
3PHGB-7	3 POINT HITCH GRADER BLADE 7 FT	264 lbs	\$985.00
3PHGBHD-7	3 POINT HITCH H.D GRADER BLADE 7 FT	521 lbs	\$1,625.00
3PHGBHD-8	3 POINT HITCH H.D GRADER BLADE 8 FT	550 lbs	\$1,845.00
ACK-7-8HD	CYLINDER KIT FOR HD GRADER BLADES		\$370.00



Heavy duty grader blade

>MULTIPLE SIZES FOR EVERY RATING OF TRACTOR

>REVERSABLE CUTTING EDGE

>ROTATING BLADE FOR PUSHING AND PULLING APPLICATIONS

>CYLINDER KIT AVAILABLE FOR THE HD GRADERS

Reg. duty Grader Blade



3 Point Hitch Land Planes

<i>Product ID</i>	<i>Description</i>	<i>Gross Weight</i>	<i>List Price</i>
LP3PH5	3 POINT HITCH LAND PLANE 5FT	640 lbs	\$1,745.00
LP3PH6	3 POINT HITCH LAND PLANE 6FT	700 lbs	\$1,845.00
LP3PH7	3 POINT HITCH LAND PLANE 7FT	770 lbs	\$2,000.00
LP3PH8	3 POINT HITCH LAND PLANE 8FT	830 lbs	\$2,200.00

Skid Steer Land Planes

<i>Product ID</i>	<i>Description</i>	<i>Gross Weight</i>	<i>List Price</i>
LPSSQA5	SKID STEER LAND PLANE 5FT	700 lbs	\$2,125.00
LPSSQA6	SKID STEER LAND PLANE 6FT	775 lbs	\$2,260.00
LPSSQA7	SKID STEER LAND PLANE 7FT	830 lbs	\$2,375.00
LPSSQA8	SKID STEER LAND PLANE 8FT	900 lbs	\$2,500.00



3 POINT HITCH LAND PLANE

SKID STEER LAND PLANE

- > Dual reversible curved 1/2" x 6" high-carbon steel blade cutting edges
- > Replaceable bolted on adjustable skid shoes
- > Approximate depth and height 51" deep x 33" high
- > Adjustable skid steer mount
- > Category 1 three point hitch
- > Quick hitch compatible
- > Rated for tractors up to 60hp



Land Levelers

<i>Product ID</i>	<i>Description</i>	<i>Gross Weight</i>	<i>List Price</i>
6FTLL	6FT LAND LEVELER		\$4,175.00
6FTLL-TILT	6FT LAND LEVELER W/ TILT		\$4,700.00
8FTLL	8FT LAND LEVELER		\$4,280.00
8FTLL-TILT	8FT LAND LEVELER W/ TILT		\$4,860.00
10FTLL	10FT LAND LEVELER		\$4,450.00
10FTLL-TILT	10FT LAND LEVELER W/ TILT		\$4,900.00
12FTLL	12FT LAND LEVELER		\$5,015.00
12FTLL-TILT	12FT LAND LEVELER W/ TILT		\$5,500.00
14FTLL	14FT LAND LEVELER		\$5,860.00
14FTLL-TILT	14FT LAND LEVELER W/ TILT		\$6,250.00
16FTLL	16FT LAND LEVELER		\$5,870.00
16FTLL-TILT	16FT LAND LEVELER W/ TILT		\$6,440.00

>MADE OF 1/4" AND 1/2" MATERIALS

>STRENGTHENED TONGUE FOR BETTER DURABILITY

>ALL MODELS HAVE LIFT

>OPTIONAL TILT FOR GRADING ON A SLOPE FOR WATER RUN OFF

>COMES WITH TIRES, HOSES AND COUPLERS.



Grapples

Skid Steer Hookup Heavy Duty Brush Grapple

<u>Product ID</u>	<u>Description</u>	<u>Gross Weight</u>	<u>List Price</u>
80HDBG	80" SS HEAVY DUTY BRUSH GRAPPLE	1050 lbs	\$5,190.00
80HDBG-AR400	80" SS HEAVY DUTY BRUSH GRAPPLE AR400	1050 lbs	\$6,800.00
54BGSQA	54" SS BRUSH GRAPPLE		\$3,700.00



- >**H.D BRUSH GRAPPLE COMES WITH TWO THUMBS**
- >**AR400 HARDEND TIPS ON GRAPPLE AND ON THUMBS**
- >**COMES WITH CYLINDERS AND HOSES**

Bucket Grapples

<u>Product ID</u>	<u>Description</u>	<u>Gross Weight</u>	<u>List Price</u>
HDGB80SSQA	HEAVY DUTY GRAPPLE FLAT BUCKET SS 80"		\$5,900.00



- >**MADE OF 1/4", 1/2" AND 3/4" MATERIALS**
- >**COMES WITH HOSES AND COUPLERS**

Skid Steer Hookup Log Grapples

<u>Product ID</u>	<u>Description</u>	<u>Gross Weight</u>	<u>List Price</u>
LGFA	LOG GRAPPLE FORKS FRAME ONLY		\$2,215.00
LGFA-42	LOG GRAPPLE 42" TINES		\$2,465.00
LGFA-48	LOG GRAPPLE 48" TINES		\$2,490.00
LGFA-54	LOG GRAPPLE 54" TINES		\$2,520.00



- >**CYLINDER GUARD TO PROTECT FROM DAMAGING THE CYLINDER**
- >**MOVE LOGS AND POSTS WITH EASE**
- >**STANDARD 16" CARRAGE**
- >**MAIN FRAME MADE OUT OF 3/8 MATERIAL**
- >**GRAPPLE MATERIAL IS MADE UP OF 1/2" AND 1/4" MATERIAL**



Skid Steer Hookup Tree Puller

<i>Product ID</i>	<i>Description</i>	<i>Gross Weight</i>	<i>List Price</i>
TPSB	TREE PULLER/STUMP BUCKET SKID STEER Q-TACH	620 lbs	\$3,095.00



- >REPLACEABLE TEETH ON THE FRONT**
- >SERRATED ARMS FOR BREAKING AND TEARING ROOTS**
- >STANDARD WITH BOLT ON OUTSIDE SERRATED PLATES**
- >REMOVABLE PROTECTIVE BACK GRILL**
- >COMES WITH HOSES AND COUPLERS**



Manure Forks

Skid Steer Hookup Manure Forks

<u>Product ID</u>	<u>Description</u>	<u>Gross Weight</u>	<u>List Price</u>
60MFSQA	SS Q-TACH MANURE FORK 60" FRAME ONLY		\$845.00
60MFSQA-35	SS Q-TACH MANURE FORK 60" FRAME 35" CRANKED TINE	465 lbs	\$1,520.00
72MFSQA	SS Q-TACH MANURE FORK 72" FRAME ONLY		\$1,015.00
72MFSQA-35	SS Q-TACH MANURE FORK 72" FRAME 35" CRANKED TINE	512 lbs	\$1,775.00
84MFSQA	SS Q-TACH MANURE FORK 84" FRAME ONLY		\$1,135.00
84MFSQA-35	SS Q-TACH MANURE FORK 84" FRAME 35" CRANKED TINE	600 lbs	\$2,065.00

Euro/ALO Hookup Manure Forks

<u>Product ID</u>	<u>Description</u>	<u>Gross Weight</u>	<u>List Price</u>
60MFEQA	EURO Q-TACH MANURE FORK 60" FRAME ONLY		\$845.00
60MFEQA-35	EURO Q-TACH MANURE FORK 60" FRAME 35" CRANKED TINE	460 lbs	\$1,520.00
72MFEQA	EURO Q-TACH MANURE FORK 72" FRAME ONLY		\$1,020.00
72MFEQA-35	EURO Q-TACH MANURE FORK 72" FRAME 35" CRANKED TINE	500 lbs	\$1,780.00
84MFEQA	EURO Q-TACH MANURE FORK 84" FRAME ONLY		\$1,135.00
84MFEQA-35	EURO Q-TACH MANURE FORK 84" FRAME 35" CRANKED TINE	600 lbs	\$2,065.00



>CONUS 1 SLEEVES

>35" CRANKED CONUS 1 TINES

>TINES ARE SPACED 8" APART

>SIDE PLATES AND WARE BAR ON BOTTOM ARE 3/8" MATERIAL

>MAIN BODY IS 1/4" MATERIAL



Rock Buckets

Skid Steer Hookup Rock Buckets

<i>Product ID</i>	<i>Description</i>	<i>Gross Weight</i>	<i>List Price</i>
66RBSQA	SS Q-TACH ROCK BUCKET 66" L 20" H 40" D	560 lbs	\$1,710.00
72RBSQA	SS Q-TACH ROCK BUCKET 72" L 20" H 40" D	600 lbs	\$1,785.00
78RBSQA	SS Q-TACH ROCK BUCKET 78" L 20" H 40" D	640 lbs	\$1,870.00
84RBSQA	SS Q-TACH ROCK BUCKET 84" L 20" H 40" D	675 lbs	\$1,975.00

Euro/ALO Hookup Rock Buckets

<i>Product ID</i>	<i>Description</i>	<i>Gross Weight</i>	<i>List Price</i>
66RBEQA	EURO Q-TACH ROCK BUCKET 66" L 20" H 40" D	560 lbs	\$1,710.00
72RBEQA	EURO Q-TACH ROCK BUCKET 72" L 20" H 40" D	600 lbs	\$1,785.00
78RBEQA	EURO Q-TACH ROCK BUCKET 78" L 20" H 40" D	640 lbs	\$1,870.00
84RBEQA	EURO Q-TACH ROCK BUCKET 84" L 20" H 40" D	675 lbs	\$1,975.00

John Deer 440/540 Hookup Rock Buckets

<i>Product ID</i>	<i>Description</i>	<i>Gross Weight</i>	<i>List Price</i>
66RBJDQA	JD440/540 Q-TACH ROCK BUCKET 66" L 20" H 40" D	560 lbs	\$1,710.00
72RBJDQA	JD440/540 Q-TACH ROCK BUCKET 72" L 20" H 40" D	600 lbs	\$1,785.00
78RBJDQA	JD440/540 Q-TACH ROCK BUCKET 78" L 20" H 40" D	640 lbs	\$1,870.00
84RBJDQA	JD440/540 Q-TACH ROCK BUCKET 84" L 20" H 40" D	675 lbs	\$1,975.00



>20" HIGH 40" DEEP

>VERTICAL SHEET METAL TINES FOR ADDED STRENGTH

>2.5" BETWEEN TINES

> 3/8" MATERIAL

Mister Picker Rock Buckets

<i>Product ID</i>	<i>Description</i>	<i>Gross Weight</i>	<i>List Price</i>
RBMP86SQA	86" MISTER PICKER ROCK BUCKET SKID STEER Q-TACH		\$4,755.00

Snow Pushers

Skid Steer Hookup Snow Pushers

<u>Product ID</u>	<u>Description</u>	<u>Gross Weight</u>	<u>List Price</u>
6SPSQA	SKID STEER Q-TACH SNOW PUSHER 6 FT	725 Lbs	\$2,225.00
7SPSQA	SKID STEER Q-TACH SNOW PUSHER 7 FT		\$2,525.00
8SPSQA	SKID STEER Q-TACH SNOW PUSHER 8 FT	835 Lbs	\$2,645.00
9SPSQA	SKID STEER Q-TACH SNOW PUSHER 9 FT		\$2,750.00
10SPSQA	SKID STEER Q-TACH SNOW PUSHER 10 FT	940 Lbs	\$2,940.00
12SPSQA	SKID STEER Q-TACH SNOW PUSHER 12 FT	1062 Lbs	\$3,170.00

Euro/ALO Hookup Snow Pushers

<u>Product ID</u>	<u>Description</u>	<u>Gross Weight</u>	<u>List Price</u>
6SPEQA	EURO Q-TACH SNOW PUSHER 6 FT	725 Lbs	\$2,225.00
7SPEQA	EURO Q-TACH SNOW PUSHER 7 FT		\$2,525.00
8SPEQA	EURO Q-TACH SNOW PUSHER 8 FT	835 Lbs	\$2,645.00
9SPEQA	EURO Q-TACH SNOW PUSHER 9 FT		\$2,750.00
10SPEQA	EURO Q-TACH SNOW PUSHER 10 FT	940 Lbs	\$2,940.00
12SPEQA	EURO Q-TACH SNOW PUSHER 12 FT	1060 Lbs	\$3,170.00



- >**COMES WITH ADJUSTIBLE HARDENED SKID SHOES**
- >**ALL PUSHERS COME WITH BACK DRAG**
- >**COMES WITH HARDENED REVERSABLE CUTTING EDGE**
- >**32" HIGH BY 36" DEEP**

Compact Snow Pushers

Snow Pushers

<u>Product ID</u>	<u>Description</u>	<u>Gross Weight</u>	<u>List Price</u>
48SP-C-SS	COMPACT SS Q-TACH SNOW PUSHER 48"		\$1,700.00
54SP-C-SS	COMPACT SS Q-TACH SNOW PUSHER 54"		\$1,725.00
60SP-C-SS	COMPACT SS Q-TACH SNOW PUSHER 60"		\$1,830.00
66SP-C-SS	COMPACT SS Q-TACH SNOW PUSHER 66"		\$1,885.00
72SP-C-SS	COMPACT SS Q-TACH SNOW PUSHER 72"		\$1,945.00



Hydraulic Snow Blades

Skid Steer Hookup Snow Blades

<i>Product ID</i>	<i>Description</i>	<i>Gross Weight</i>	<i>List Price</i>
8HYDSQASB	SKID STEER Q-TACH HYDRAULIC SNOW BLADE 8 FT		\$4,500.00
10HYDSQASB	SKID STEER Q-TACH HYDRAULIC SNOW BLADE 10 FT		\$4,615.00



>25" HIGH MOLDBOARD

>COMES WITH DUAL CYLINDERS FOR ANGLE

>COMES WITH SPRING TRIP EDGE

>COMES WITH HOSES

>AVAILABLE IN SKID STEER AND EURO HOOKUP



Rotary Cutters

Skid Steer Hookup Rotary Cutters

<u>Product ID</u>	<u>Description</u>	<u>Gross Weight</u>	<u>List Price</u>
72RC-SSQA	72" ROTARY CUTTER SKID STEER Q-TACH		\$5,575.00
72RC-3PH	72" ROTARY CUTTER 3PH		\$4,395.00
RC-WHEEL	ROTARY CUTTER WHEEL		\$450.00



- >72" Cutting Path**
- >78" Overall Width**
- >3/16" Material for the Deck**
- >Front wheel (Optional)**

Lawn Rollers

Tow Behind Rollers

<i>Product ID</i>	<i>Description</i>	<i>Gross Weight</i>	<i>List Price</i>
24X48DR	24" DRUM ROLLER 48" WIDE	325 Lbs	\$940.00
24X60DR	24" DRUM ROLLER 60" WIDE	380 Lbs	\$1,060.00
24X72DR	24" DRUM ROLLER 72" WIDE	440 Lbs	\$1,200.00
30X48DR	30" DRUM ROLLER 48" WIDE	405 Lbs	\$1,250.00
30X60DR	30" DRUM ROLLER 60" WIDE	575 Lbs	\$1,430.00
30X72DR	30" DRUM ROLLER 72" WIDE	675 Lbs	\$1,600.00

- >1/8 Material**
- >Drain plug for adding water for extra weight**
- >1/4" 2x2 tubing for the frame**



Boom Poles

Skid Steer Hookup Boom Poles

<i>Product ID</i>	<i>Description</i>	<i>Gross Weight</i>	<i>List Price</i>
10BPSQA	10FT TELESCOPIC SKID STEER BOOM POLE	310 Lbs	\$1,375.00
10BPEQA	10FT TELESCOPIC EURO BOOM POLE	310 Lbs	\$1,475.00

- > Skid steer and Euro hookup**
- > 75" main boom with 48" telescopic boom**
- >Pintle hook on end with spring-loaded locking arm & pin**
- >3000 lbs capacity closed & 1500 lbs capacity extended**

MT Style Attachments

MT Manure Forks

<u>Product ID</u>	<u>Description</u>	<u>Gross Weight</u>	<u>List Price</u>
36MFMINIBC	36" MINI SKID STEER MANURE FORK FRAME ONLY		\$480.00
36MFMINIBC-35	48" MINI BOBCAT MANURE FORK W/ 35" CRANKED TINES		\$565.00
48MFMINIBC	36" MINI SKID STEER MANURE FORK FRAME ONLY		\$640.00
48MFMINIBC-35	48" MINI BOBCAT MANURE FORK W/ 35" CRANKED TINES		\$950.00

MT Bale Spears

<u>Product ID</u>	<u>Description</u>	<u>Gross Weight</u>	<u>List Price</u>
MINIBC-2PBS	2 PRONG BALE SPEAR MINI BOBCAT		\$495.00
MINIBC-2PBS	2 PRONG BALE SPEAR MINI BOBCAT W/ 39" TINES		\$755.00
DPD-2X2	2 PRONG SLIDE IN BALE SPEAR TUBE 2X2 SET		\$175.00

MT PALLET FORKS

MINI-20SQAPF	2000lb MINI BOBCAT PALLET FORK FRAME ONLY		\$350.00
MINI-20SQAPF-42	2000lb MINI BOBCAT PALLET FORKS W/ 42" FORKS		\$515.00



Pins, Adapters, & Accessories

Adapters and plates

<u>Product ID</u>	<u>Description</u>	<u>Gross Weight</u>	<u>List Price</u>
THSSQA	TRAILER HITCH SKID STEER Q-TACH		\$300.00
HHTHSQA	HAND HELD TRAILER HITCH SKID STEER Q-TACH		\$205.00
SSQAWOK	SKID STEER Q-TACH WELD PLATE		\$250.00
JDQAWOK	JD440/540 WELD ON PLATE		\$295.00
FWOEQA	EURO Q-TACH WELD PLATE		\$315.00
EQAWOK	EURO Q-TACH WELD ON HOOKS		\$130.00
SSQABOSP	SKID STEER Q-TACH BOLT ON MOUNT FOR SNOW PUSHER		\$300.00
EQABOSP	EURO Q-TACH BOLT ON MOUNT FOR SNOW PUSHER		\$330.00
JCB406QABOSP	JCB 406-QA BOLT ON MOUNT FOR SNOW PUSHER		
SSQA-EURO	SKID STEER TO EURO ADAPTER		\$1,030.00
EURO-SSQA	EURO TO SKID STEER ADAPTER		\$1,550.00
QUICK3PH-1	CLASS 1 QUICK HITCH		\$470.00
QUICK3PH-2	CLASS 2 QUICK HITCH		\$600.00

FORKS, SPEARS, & TINES

<u>Product ID</u>	<u>Description</u>	<u>Gross Weight</u>	<u>List Price</u>
4X1.5X42	42" 2A 4X1.5X54 FORKS 16" CARRIAGE	47 Lbs	\$140.00
4X1.5X48	48" 2A 4X1.5X54 FORKS 16" CARRIAGE	52 Lbs	\$150.00
4X1.5X54	54" 2A 4X1.5X54 FORKS 16" CARRIAGE	56 Lbs	\$170.00
BT-39	39" BALE TINE, COMES W/NUT		\$145.00
BT-49	49" BALE TINE, COMES W/NUT		\$180.00
MT-35	35" CRANKED CONUS 1 MANURE FORK TINE W/NUT		\$70.00

Fork Extensions

<u>Product ID</u>	<u>Description</u>	<u>Gross Weight</u>	<u>List Price</u>
6FE	6FT FORK EXTENSIONS		\$400.00
78FE	78" FORK EXTENSIONS		\$440.00
8FE	8FT FORK EXTENSIONS		\$575.00
9FE	9FT FORK EXTENSIONS		\$650.00
10FE	10FT FORK EXTENSIONS		\$725.00
11FE	11FT FORK EXTENSIONS		\$1,070.00
12FE	12FT FORK EXTENSIONS		\$1,155.00



PINS

<i>Product ID</i>	<i>Description</i>	<i>Gross Weight</i>	<i>List Price</i>
LP-6	1/4" X 1.75" LYNCH PIN		\$0.48
LP-8	5/16" X 1.75 LYNCH PIN		\$0.48
BP-127	1/2" X 3" BENT HITCH PIN		\$3.15
HP-22	7/8" X 4.25" HITCH PIN		\$10.50
DP-22	3 POINT HITCH LIFT PIN, CAT 1		\$9.75
RHHP-19114	3/4" X 4-1/2" RED HANDLE HITCH PIN		\$5.67
RHHP-19165	3/4" X 6-1/2" RED HANDLE HITCH PIN		\$6.69
RHHP-22114	7/8" X 4-1/2" RED HANDLE HITCH PIN		\$8.52
RHHP-22165	7/8" X 6-1/2" RED HANDLE HITCH PIN		\$7.80
RHHP-25114	1" X 4-1/2" RED HANDLE HITCH PIN		\$8.52
RHHP-22216	1-1/8" X 8-1/2" RED HANDLE HITCH PIN		\$14.28



RED HANDLE HITCH PIN



LYNCH PIN



BENT HITCH PIN



3PH PIN

Replacement Parts

<i>Product ID</i>	<i>Description</i>	<i>Gross Weight</i>	<i>List Price</i>
BBLPS	BOX BLADE/LAND PLANE SHANK		\$55.00
RC-BLADE	ROTARY CUTTER BLADES	9 LBS	\$75.00
RC-BLADE BOLT	ROTARY CUTTER BLADE BOLT		\$110.00

CUTTING EDGES & GRADER BLADES

<i>Product ID</i>	<i>Description</i>	<i>Gross Weight</i>	<i>List Price</i>
DBF-3/4X6X68-B	68" 3/4" X 6" BOLT ON CUTTING EDGE		\$180.00
DBF-3/4X6X74-B	74" 3/4" X 6" BOLT ON CUTTING EDGE		\$190.00
DBF-3/4X6X80-B	80" 3/4" X 6" BOLT ON CUTTING EDGE		\$210.00
DBF-3/4X6X86-B	86" 3/4" X 6" BOLT ON CUTTING EDGE		\$225.00
DBF-3/4X6X92-B	92" 3/4" X 6" BOLT ON CUTTING EDGE		\$240.00
DBF-3/4X6X98-B	98" 3/4" X 6" BOLT ON CUTTING EDGE		\$260.00
DBF-3/4X6X104-B	104" 3/4" X 6" BOLT ON CUTTING EDGE		\$280.00
DBF-3/4X6X-110-B	110" 3/4" X 6" BOLT ON CUTTING EDGE		\$300.00
GB-1/2X6X48-C	1/2X6X4' (5/8B) CTR PU BLACK GR/BL		\$65.00
GB-1/2X6X54-C	1/2X6X4.5' (5/8B) CTR PU BLACK GR/BL		\$75.00
GB-1/2X6X60-C	1/2X6X5' (5/8B) CTR PU BLACK GR/BL		\$85.00
GB-1/2X6X72-C	1/2X6X6' (5/8B) CTR PU BLACK GR/BL		\$95.00
GB-1/2X6X84-C	1/2X6X7' (5/8B) CTR PU BLACK GR/BL		\$105.00
GB-1/2X6X96-C	1/2X6X8' (5/8B) CTR PU BLACK GR/BL		\$115.00



Mapleside Mfg. INC. Product Warranty

Mapleside. Mfg. INC. (Mapleside Mfg) stands behind the quality of our products and offers the following warranty to provide peace of mind to our valued customers:

Duration of Warranty:

All new products manufactured by Mapleside Mfg are warranted to be free from defects in materials and/or workmanship for a comprehensive period of 2 years. This warranty is extended exclusively to the original end-user and becomes effective on the date the original end-user receives the product.

Coverage and Limitations:

Mapleside Mfg's obligation under this warranty is limited to the repair or replacement of any part(s) proven to be defective in materials and/or workmanship under normal use and service. The determination of defects will be made by Mapleside Mfg through photographic evidence or other means as necessary.

"Normal use and service" refers to the usage consistent with the intended purpose of the goods and within conditions normally encountered through proper use. Any evidence of improper use, neglect, unauthorized repair, or alteration to the original design may void this warranty.

Warranty Claims Process:

Warranty claims must be initiated through an authorized Mapleside Mfg dealer. The dealer is required to contact Mapleside Mfg and obtain authorization before conducting any warranty work. Failure to secure prior authorization may result in rejected warranty claims.

Mapleside Mfg reserves the right to modify specifications and/or designs at any time for any product for sale, without obligation to owners of previously purchased products.

Exclusions from Warranty:

This warranty explicitly excludes the following items:

- Normal maintenance or adjustments
- Products lost or damaged during shipment
- Accessory items and parts not supplied by Mapleside Mfg

All warranty claims must be discussed with an authorized employee of Mapleside Mfg prior to any repairs being performed.

Mapleside Mfg makes no warranties beyond those expressly stated in this document, and no person is authorized to make any other warranties binding upon Mapleside Mfg with respect to products manufactured by Mapleside. Mfg. INC. Our commitment is to your satisfaction and the enduring quality of our products.

Rep'd by...

HARCOAG
EQUIPMENT

Mapleside Manufacturing
793202 Grey Road 124
Creemore, Ontario, L0M 1G0

www.maplesidemfg.ca



PRO-DIG



*PRO SLICE BRACKET PRICE INCREASE
 APRIL 1/25

FEEDING RANGE

ProDig Attachments

Product Code #	Description	Size	List Price [CDN]
SHEAR GENIUS			
GS 1500	Shear Genius	1.5m	\$13,293.00
GS 1800	Shear Genius	1.8m	14,624.00
GS 2200	Shear Genius	2.2m	15,288.00
GS 2500	Shear Genius	2.5m	16,174.00
TBB 100	Tractor bolt on brackets		*571.00
IDBB 100	Industrial bolt on brackets <i>(Price does not include brackets)</i>		*799.00
MEGA BITE			
MB 1500	Mega Bite	1.5m	\$13,293.00
MB 1800	Mega Bite	1.8m	14,180.00
MB 2200	Mega Bit	2.2m	15,066.00
MB PO	Twin Cylinder Push Off		1,662.00
MP3-1500-F-MESH	1.5m Maize Infill Panel (not compatible w/Push Off.)		166.00
MP3-1800-F-MESH	1.8m Maize Infill Panel (not compatible w/Push Off.)		219.00
MP3-2200-F-MESH	2.2m Maize Infill Panel (not compatible w/Push Off.)		285.00
TBB 100	Tractor bolt on brackets		*571.00
IDBB 100	Industrial bolt on brackets		*799.00
MBNG	Removal of plastic/net gripper unit		554.00
HX TIP	Replacement weld on hardox wear tips for tines <i>(Price does not include brackets)</i>	Each	39.00
PRO SLICE			
BS-B0S	Pro Slice -complete with plastic/net gripper		\$8,418.00
Optional Extras			
TBB100	Tractor Bolt on Brackets		*571.00
IDBB100	Industrial Bolt on Brackets		*799.00
980SFT	Extra Tines (pair) for carrying 2 bales		266.00
GRAPPLE BUCKETS - TRACTOR			
GPTG 1500	Grapple Buckets – Tractor	1.5m	\$6,202.00
GPTG 1800	Grapple Buckets – Tractor	1.8m	6,645.00
GPTG 2100	Grapple Buckets – Tractor	2.1m	6,978.00
GPTGS	Removable Bucket Sides		454.00
BOCE 200x25	Bolt on cutting edge (per metre) <i>(Price include brackets)</i>	200x25mm	554.00
GRAPPLE BUCKET - TELEHANDLER			
GPG 0.8	Grapple Bucket – Tele-Handler	1.8m	\$8,196.00
GPG 1.1	Grapple Bucket – Tele-Handler	2.3m	8,196.00
GPG 1.5	Grapple Bucket – Tele-Handler	2.5m	8,861.00
GPG 1.7	Grapple Bucket – Tele-Handler	2.5m	9,526.00
GPTGS	Removable Bucket Sides		532.00
BOCE 200x25	Bolt on cutting edge (per metre) <i>(Price includes weld on brackets, bolt on also available)</i>	200x25mm	554.00

PRICED IN CANADIAN DOLLARS

PRICES ARE FOB HARRISTON, ON – DESIGN & PRICE ARE SUBJECT TO CHANGE WITHOUT NOTICE



*PRO SLICE BRACKET PRICE INCREASE
 APRIL 1/25

FEEDING RANGE ProDig Attachments

Product Code #	Description	Size	List Price [CDN]
PRO SHEAR GRABS			
SG 1300	Shear Grab	1.3m	\$8,196.00
SG 1500	Shear Grab	1.5m	8,640.00
SG 1800	Shear Grab	1.8m	9,748.00
SG 2200	Shear Grab	2.2m	11,077.00
SG-PO-01	Single Cylinder Push Off		1,551.00
SG-1300-F-MESH	1.3m Maize Infill Panel		244.00
SG-1300-PO-MESH	1.3m Maize Infill Panel (no centre for Push Off)		111.00
SG-1500-F-MESH	1.5m Maize Infill Panel		299.00
SG-1500-PO-MESH	1.5m Maize Infill Panel (no centre for Push Off)		166.00
SG-1800-F-MESH	1.8m Maize Infill Panel		344.00
SG-1800-PO-MESH	1.8m Maize Infill Panel (no centre for Push Off)		211.00
SG-2200-F-MESH	2.2m Maize Infill Panel		454.00
SG-2200-PO-MESH	2.2m Maize Infill Panel (no centre for Push Off)		321.00
TBB 100	Tractor bolt on brackets		*571.00
IDBB 100	Industrial bolt on brackets		*799.00
HX TIP	Replacement weld on hardox wear tips for tines <i>(Price does not include brackets)</i>	Each	39.00

Shear Grab	SG1300 HX	SG 1500 HX	SG 1800 HX	SG 2200 HX
Height (mm)	(1034) – 41"	(1034) – 41"	(1034) – 41"	(1034) – 41"
Width (mm)	(1320) – 52"	(1520) – 60"	(1820) – 72"	(2220) – 87"
Depth (mm)	(1100) – 43"	(1100) – 43"	(1100) – 43"	(1100) – 43"
Capacity (m3)	.92	1.06	1.28	1.56
Weight (kg) – lbs	(561) – 1246 lbs.	(603) – 1329 lbs.	(687) – 1514 lbs.	(793) – 1748 lbs.
Number of Tines	9 Hardox	10 Hardox	12 Hardox	15 Hardox
Tine spacing (mm)	(116) – 4.5"	(122) – 5"	(121) – 5"	(116) – 4.5"
Tine length (mm)	(885) – 35"	(885) – 35"	(885) – 35"	(885) – 35"
Rams	2x90mm Bore	20x90mm Bore	2x100mm Bore	2x100mm Bore
Opening Hgt (mm)	(800) – 31.5"	(800) – 31.5"	(800) – 31.5"	(800) – 31.5"
Pressure Relief Valve	Optional	Optional	Optional	Optional

All measurements are approximate – Weight excludes brackets as these vary.



PRICED IN CANADIAN DOLLARS

PRICES ARE FOB HARRISTON, ON – DESIGN & PRICE ARE SUBJECT TO CHANGE WITHOUT NOTICE



*PRO SLICE BRACKET PRICE INCREASE
 APRIL 1/25

FEEDING RANGE ProDig Attachments

Product Code #	Description	Size	List Price (CDN)
TRACTOR TINE GRAB			
TTG 1300	Tine Grab – Tractor	1.3m	\$6,202.00
TTG 1500	Tine Grab – Tractor	1.5m	6,424.00
TTG 1800	Tine Grab – Tractor	1.8m	6,645.00
TBB 100	Tractor bolt on brackets		*571.00
IDBB 100	Industrial bolt on brackets		*799.00
HX TIP	Replacement weld on hardox wear tips for tines <i>(Price does not include brackets)</i>	each	39.00
TELEHANDLER TINE GRAB			
TG 1500	Tine Grab – Tele-Handler	1.5m	\$6,867.00
TG 1800	Tine Grab – Tele-Handler	1.8m	7,310.00
TG 2200	Tine Grab – Tele-Handler	2.2m	9,526.00
TG 2500	Tine Grab – Tele-Handler	2.5m	10,191.00
TBB 100	Tractor bolt on brackets		*571.00
IDBB 100	Industrial bolt on brackets		*799.00
HX TIP	Replacement weld on hardox wear tips for tines <i>(Price does not include brackets)</i>	each	39.00



PRICED IN CANADIAN DOLLARS

PRICES ARE FOB HARRISTON, ON – DESIGN & PRICE ARE SUBJECT TO CHANGE WITHOUT NOTICE



*PRO SLICE BRACKET PRICE INCREASE
 APRIL 1/25

FEEDING RANGE ProDig Attachments

Product Code #	Description	Size	List Price (CDN)
CHOP 'N' FEED BUCKET			
CNF2000	Chop 'n Feed Bucket	2.0m	\$11,299.00
CNF2300	Chop 'n Feed Bucket	2.3m	11,742.00
CNF2500	Chop 'n Feed Bucket	2.5m	12,407.00
TBB100-3PL-C2-CNF	3-Point linkage w/hyd top link		1,662.00
CNF-300-EXT-01	Long Spout Extension	300mm	399.00
TBB 100	Tractor bolt on brackets		*571.00
IDBB 100	Industrial bolt on brackets <i>(Price does not include brackets)</i>		*799.00



PRICED IN CANADIAN DOLLARS

PRICES ARE FOB HARRISTON, ON – DESIGN & PRICE ARE SUBJECT TO CHANGE WITHOUT NOTICE



*PRO SLICE BRACKET PRICE INCREASE
 APRIL 1/25

GRASS HANDLING RANGE

ProDig Attachments

Product Code #	Description	Size	List Price (CDN)
BALE HANDLER			
BH 500	Hydraulic Bale Handler (Includes std rollers)		\$3,100.00
BH 500 EQ	Hydraulic Bale Handler-Weld on euro hitch (Inc std rollers)		3,210.00
BH 500 QRR	Quick Release Rollers	per pair	288.00
TBB 100	Tractor bolt on brackets		*571.00
IDBB 100	Industrial bolt on brackets <i>(Price does not include brackets-except BH 500 EQ)</i>		*799.00



Product Code #	Description	Size	List Price [CDN]
HYDRAULIC BALE GRAB			
BG 500	Hydraulic Bale Grab (excludes check valve)		\$3,321.00
BG 500 EQ	Hydraulic Bale Grab-Weld on euro hitch (excludes check valve)		3,432.00
BG 500-CV	Optional check valve		222.00
TBB 100	Tractor bolt on brackets		*571.00
IDBB 100	Industrial bolt on brackets <i>(Price does not include brackets-except BG 500EQ)</i>		*799.00



Product Code #	Description	Size	List Price [CDN]
BALE STACKERS			
C320	Bale Stacker (3 square, 2 round)		\$9,969.00
C430	Bale Stacker (4 square, 3 round)		11,077.00
TBB 100	Tractor bolt on brackets		*571.00
IDBB 100	Industrial bolt on brackets		*799.00
C320-C430-FUS-01	C320-C430 Bottom bar hydraulic fold up system <i>(Price does not include brackets)</i>		1,363.00



PRICED IN CANADIAN DOLLARS

PRICES ARE FOB HARRISTON, ON – DESIGN & PRICE ARE SUBJECT TO CHANGE WITHOUT NOTICE



*PRO SLICE BRACKET PRICE INCREASE
 APRIL 1/25

GRASS HANDLING RANGE

ProDig Attachments

Product Code #	Description	Size	List Price (CDN)
PUSH OFF GRASS FORKS			
POGF 2500 HX	Push Off Grass Fork – Hardox Tines	2.5m	\$17,504.00
POGF 2750 HX	Push Off Grass Fork – Hardox Tines	2.75m	18,390.00
POGF 3000 HX	Push Off Grass Fork – Hardox Tines	3.0m	18,833.00
POGF 3300 HX	Push Off Grass Fork – Hardox Tines	3.3m	19,498.00
POGF 3600 HX	Push Off Grass Fork – Hardox Tines	3.6m	20,163.00
POGF 4000 HX	Push Off Grass Fork – Hardox Tines	4.0m	21,271.00
PUSH OFF GRASS FORKS – FORGED TINES			
POGF 2500 RT	Push Off Grass Fork – Forged Tines	2.5m	\$17,282.00
POGF 2750 RT	Push Off Grass Fork – Forged Tines	2.75m	18,168.00
POGF 3000 RT	Push Off Grass Fork – Forged Tines	3.0m	18,390.00
POGF 3300 RT	Push Off Grass Fork – Forged Tines	3.3m	18,833.00
POGF 3600 RT	Push Off Grass Fork – Forged Tines	3.6m	19,498.00
POGF 4000 HX	Push Off Grass Fork – Forged Tines	4.0m	20,163.00
POGF BB	Bolt on Hitch (3 pt linkage or industrial loader bracket)		\$1,030.00
POGF KILESKIFT	Extra for Kileskift Hitch (custom hitches priced accordingly)		2,360.00
POGF LK	Lighting Kit (work & road transport lights)		1,208.00
POGF-GATE-LOCK-01	Bolt on Gate Locking Latch – per pair		576.00
COLOUR	Colour options (any off standard colour)		288.00
HX TIP XL	Replacement weld on Hardox wear tips for tines		55.00



PUSH THAT LOAD WITH EASE

PUSH OFF GRASS FORK

- Available in 2.5m to 4.0m
- Twice as effective over using a blade
- Less horsepower required
- Less fuel used
- Can also be used on Wheel Loaders
- 40mm Hardox tines 1400mm long
- Only 1 hydraulic service required
- 40mm greasable pins with bushings



PRICED IN CANADIAN DOLLARS

PRICES ARE FOB HARRISTON, ON – DESIGN & PRICE ARE SUBJECT TO CHANGE WITHOUT NOTICE



*PRO SLICE BRACKET PRICE INCREASE
 APRIL 1/25

GRASS HANDLING RANGE

ProDig Attachments

Product Code #	Description	Size	List Price [CDN]
FOLDING GRASS FORKS – MAMMOTH			
MAMMOTH-36-S	Grass Forks – Folding 1525 mm tines	3600mm 12'	\$21,492.00
MAMMOTH-36	Grass Forks - Folding 1829 mm tines	3600mm 12'	22,157.00
MAMMOTH-36-XL	Grass Forks - Folding 2090 mm tines	3600mm 12'	23,044.00
MAMMOTH-42	Grass Forks – Folding 1829 mm tines	4200mm 14'	23,708.00
MAMMOTH-42-XL	Grass Forks – Folding 2090 mm tines	4200mm 14'	24,816.00
MAMMOTH-49	Grass Forks – Folding 1829 mm tines	4900mm 16'	25,481.00
MAMMOTH-49-XL	Grass Forks – Folding 2090 mm tines	4900mm 16'	26,589.00
MAMMOTH-55	Grass Forks – Folding 1829 mm tines	5500mm 18'	27,697.00
MAMMOTH-55-XL	Grass Forks – Folding 2090 mm tines	5500mm 18'	28,805.00
CONTINENTAL FOLDING GRASS FORKS - TAURUS			
TAURUS-36-S	Grass Forks – Folding – 1524 mm tines	3600mm 12'	\$21,049.00
TAURUS-36	Grass Forks – Folding – 1829 mm tines	3600mm 12'	21,714.00
TAURUS-36-XL	Grass Forks – Folding – 2090 mm tines	3600mm 12'	22,379.00
TAURUS-42	Grass Forks – Folding – 1829 mm tines	4200mm 14'	23,265.00
TAURUS-42-XL	Grass Forks – Folding – 2090 mm tines	4200mm 14'	23,930.00
TAURUS-49	Grass Forks – Folding – 1829 mm tines	4900mm 16'	25,260.00
TAURUS-49-XL	Grass Forks – Folding – 2090 mm tines	4900mm 16'	25,924.00
TAURUS-55	Grass Forks – Folding – 1829 mm tines	5500mm 18'	27,254.00
TAURUS-55-XL	Grass Forks – Folding – 2090 mm tines	5500mm 18'	28,140.00

Product Code	Description	List Price [CDN]
FGF-MB-36	Maize Blade complete to suit Taurus-36	\$2,216.00
FGF-MB-42	Maize Blade complete to suit Taurus-42	2,493.00
FGF-MB-49	Maize Blade complete to suit Taurus-49	2,770.00
FGF-MB-55	Maize Blade complete to suit Taurus-55	3,047.00
FGF-FBMB-36	Full Bottom Maize Blade to suit Taurus-36	4,388.00
FGF-FBMB-42	Full Bottom Maize Blade to suit Taurus-42	4,953.00
FGF-FBMB-49	Full Bottom Maize Blade to suit Taurus-49	5,485.00
FGF-FBMB-55	Full Bottom Maize Blade to suit Taurus-55	6,050.00
FGF KILESKIFT	Extra for Kileskift Hitch (custom hitches priced accordingly)	1,939.00
FGF FLK	Work lighting kit (2 LED work lights)	1,086.00
FGF TG	Transport Tine Guard	1,374.00
FGF FDV	Flow Divider Valve (for even oil flow to each side of fork)	310.00
COLOUR	Colour options (any off standard colour)	288.00
HX TIP XL	Replacement Hardox wear tips for tines (each)	55.00

Price includes Euro 50 brackets, double side tines & hydraulic check valve

PRICED IN CANADIAN DOLLARS

PRICES ARE FOB HARRISTON, ON – DESIGN & PRICE ARE SUBJECT TO CHANGE WITHOUT NOTICE



*PRO SLICE BRACKET PRICE INCREASE
 APRIL 1/25

GRASS HANDLING RANGE

Product Code #	Description	Size	List Price [CDN]
PUSH OFF FOLDING GRASS FORKS			
POFGF 4200	Push Off Folding Grass Fork	4.2m	\$38,777.00
POFGF 4900	Push Off Folding Grass Fork	4.9m	44,317.00
POFGF TG	Transport Tine Guard		1,374.00
POGF BB	Bolt on hitch (3pt linkage or industrial loader bracket)		1,030.00
POGF KILESKIFT	Extra for Kileskift Hitch (custom hitches priced accordingly)		2,360.00
COLOUR	Colour options (any off standard colour)		288.00
HX TIP XL	Replacement hardox wear tips for tines (each)		55.00

Product Code #	Description	Size	List Price [CDN]
GRASS FORKS – TELEHANDLER			
GF 2200	Grass Forks – Tele-Handler	2.2m	\$5,537.00
GF 2500	Grass Forks – Tele-Handler	2.5m	5,980.00
GF 2700	Grass Forks – Tele-Handler	2.7m	6,424.00
GF 3000	Grass Forks – Tele-Handler	3.0m	6,867.00
TBB 100	Tractor bolts on brackets		*571.00
IDBB 100	Industrial bolt on brackets		*799.00
HX TIP	Replacement weld on hardox wear tips for tines		39.00

GRASS FORKS - CONTRACTOR			
CF 2500	Grass Forks – Contractor	2.5m	\$9,748.00
CF 2750	Grass Forks - Contractor	2.75m	10,412.00
CF 3000	Grass Forks - Contractor	3.0m	11,299.00
CF 3300	Grass Forks - Contractor	3.3m	11,964.00
CF 3600	Grass Forks - Contractor	3.6m	12,628.00
FGF DST	Double side tines		632.00
FGF ZUC	Bolt in centre section for Z-linkage		233.00
FGF TG	Transport tine guard		1,252.00
COLOUR	Colour options (any off standard colour)		299.00
HX TIP XL	Replacement weld on hardox wear tips for tines (Price includes weld on brackets, bolt on also available.)		55.00



Product Code #	Description	Size	List Price [CDN]
SILAGE COMPACTOR			
SC-2500	Silage Compactor Sliding	2.5m	\$26,589.00
SC-3000	Silage Compactor Sliding	3.0m	31,021.00
SC-F-2500	Silage Compactor Fixed	2.5m	22,157.00
SC-F-3000	Silage Compactor Fixed	3.0m	23,708.00
SC-ARM	Silage Compactor Bolt on Arm		11,077.00



PRICED IN CANADIAN DOLLARS

PRICES ARE FOB HARRISTON, ON – DESIGN & PRICE ARE SUBJECT TO CHANGE WITHOUT NOTICE



*PRO SLICE BRACKET PRICE INCREASE
 APRIL 1/25

GRAIN INDUSTRIAL HANDLING RANGE

ProDig Attachments

Product Code #	Description	Size	List Price [CDN]
HI-TIP BUCKET			
HTB 2.2*	Hi Tip Bucket	2.5m	\$15,509.00
HTB 3.2*	Hi Tip Bucket	2.75m	16,108.00
HTB 3.5*	Hi Tip Bucket	3.0m	16,329.00
HTB 3.25*	Hi Tip Bucket	2.5m	16,218.00
HTB 3.65*	Hi Tip Bucket	2.75m	16,462.00
HTB 4.0*	Hi Tip Bucket	3.0m	16,617.00
HTB 4.3*	Hi Tip Bucket	3.2m	16,839.00
HTB 4.15	Hi Tip Bucket	2.5m	16,839.00
HTB 4.6	Hi Tip Bucket	2.75m	17,504.00
HTB 5.0	Hi Tip Bucket	3.0m	17,725.00
HTB 5.4	Hi Tip Bucket	3.2m	18,168.00
HTB 5.1	Hi Tip Bucket	2.5m	17,903.00
HTB 5.5	Hi Tip Bucket	2.75m	18,346.00
HTB 6.0	Hi Tip Bucket	3.0m	18,745.00
HTB 6.45	Hi Tip Bucket	3.2m	18,944.00
HTB 6.15	Hi Tip Bucket	2.5m	19,055.00
HTB 6.8	Hi Tip Bucket	2.75m	20,207.00
HTB 7.4	Hi Tip Bucket	3.0m	20,384.00
HTB 8.0	Hi Tip Bucket	3.2m	20,607.00

*Requires bolt on bracket



Product Code #	Description	Size	List Price [CDN]
HTBB 100*	Industrial bolt on bracket *		1,042.00
BOCE 3P 200x25	Bolt on cutting edge (per metre)	200x25mm	554.00
BOCE 3P 250x30	Bolt on cutting edge (per metre)	250x30mm	809.00
WOCE 200x25	Weld on edge, welded to main cutting edge (per metre)	200x25mm	465.00
HTB ZUCF	Z linkage cut out (bolt in flat plate section)		554.00
HTB ZUCW	Z linkage cut out (bolt in z-linkage well)		864.00
HTB-SF-300	HTB 300mm spill frame (3 part for flat plate section)		1,263.00
HTB-SF-300-U	HTB 300mm spill frame (3 part for Z-linkage well)		1,562.00
COLOUR	Colour options (any off standard colour)		321.00
KILESKIFT	Extra over for Kileskift hitch		1,130.00
<i>(Price includes weld on brackets)</i>			



PRICED IN CANADIAN DOLLARS

PRICES ARE FOB HARRISTON, ON – DESIGN & PRICE ARE SUBJECT TO CHANGE WITHOUT NOTICE



*PRO SLICE BRACKET PRICE INCREASE
 APRIL 1/25

GRAIN INDUSTRIAL HANDLING RANGE ProDig Attachments

MINI HI-TIP BUCKET			
HTBSS 1500	Mini Hi Tip Bucket	1.5m	\$8,573.00
HTBSS 1800	Mini Hi Tip Bucket	1.8m	8,861.00
HTBSS 2000	Mini Hi Tip Bucket	2.0m	8,994.00
HTBSS 1500-H	Mini High Capacity Hi Tip Bucket	1.5m	8,861.00
HTBSS 1800-H	Mini High Capacity Hi Tip Bucket	1.8m	8,861.00
HTBSS 2000-H	Mini High Capacity Hi Tip Bucket <i>(Price does not include brackets)</i>	2.0m	9,260.00



Product Code #	Description	Size	List Price [CDN]
GRAIN BUCKET			
GB 1.9	Grain Bucket	2.28m	\$5,936.00
GB 2.1	Grain Bucket	2.5m	6,424.00
GB 2.3	Grain Bucket	2.75m	6,756.00
GB 2.5	Grain Bucket	3.0m	7,199.00
GB 2.7	Grain Bucket	2.28m	7,532.00
GB 3.0	Grain Bucket	2.5m	7,953.00
GB 3.3	Grain Bucket	2.75m	8,861.00
GB 3.6	Grain Bucket	3.0m	9,304.00
GB 4.0	Grain Bucket	2.5m	10,102.00
GB 4.5	Grain Bucket	2.75m	10,634.00
GB 4.9	Grain Bucket	3.0m	11,299.00
BOCE 200x25	Bolt on cutting edge (per metre) <i>(Price includes weld on brackets)</i>	200x25mm	554.00
BOCE 250x30	Bolt on cutting edge (per metre) <i>(Price includes weld on brackets)</i>	250x30mm	809.00



PRICED IN CANADIAN DOLLARS

PRICES ARE FOB HARRISTON, ON – DESIGN & PRICE ARE SUBJECT TO CHANGE WITHOUT NOTICE



GRAIN INDUSTRIAL HANDLING RANGE

ProDig Attachments

*PRO SLICE BRACKET PRICE INCREASE
 APRIL 1/25

TRACTOR LOADER BUCKET			
GPT 1500	Loader Bucket – Tractor	1.5m	\$2,213.00
GPT 1800	Loader Bucket – Tractor	1.8m	2,324.00
GPT 2100	Loader Bucket – Tractor	2.1m	2,612.00
GPT 2500	Loader Bucket – Tractor	2.5m	2,967.00
BOCE 200x25	Bolt on cutting edge (per metre) <i>(Price includes weld on brackets)</i>	200x25mm	554.00



TELEHANDLER LOADER BUCKET			
GP0.8	Loader Bucket – Telehandler	1.8m	\$3,321.00
GP1.1	Loader Bucket – Telehandler	2.3m	3,543.00
GP1.5	Loader Bucket – Telehandler	2.5m	4,341.00
GP1.7	Loader Bucket – Telehandler	2.5m	4,540.00
GP-HD	Extra over for high volume sides		1,363.00
BOCE 200x25	Bolt on cutting edge (per metre) <i>(Price includes weld on brackets)</i>	200x25mm	554.00
BOCE 250x30	Bolt on cutting edge (per metre)	250x30mm	809.00



PRICED IN CANADIAN DOLLARS

PRICES ARE FOB HARRISTON, ON – DESIGN & PRICE ARE SUBJECT TO CHANGE WITHOUT NOTICE



*PRO SLICE BRACKET PRICE INCREASE
 APRIL 1/25

GRAIN INDUSTRIAL HANDLING RANGE

ProDig Attachments

COMMODITY BAG FILLERS (Grain, Fertilizer, Sand, Stone, Plastic Pellets)

Product Code #	Description	Size	List Price [CDN]
BAG FILLER BUCKETS			
BF3 600	Bag Filler Bucket w/swinging door system	0.6m3	\$7,751.00
BF3 1000	Bag Filler Bucket w/swinging door system	1.0m3	8,349.00
BF3 1400	Bag Filler Bucket w/swinging door system	1.4m3	9,080.00
BF3 2000	Bag Filler Bucket w/swinging door system	2.0m3	10,366.00
IDBB 100	Industrial bolt on brackets		799.00
FBF WD	Weigh Load System w/Digital Display		3,656.00
BOCE 200x25	Bolt on cutting edge (per metre) <i>(Price does not include brackets)</i>	200x25mm	554.00



COMMODITY BAG FILLERS (Grain, Fertilizer, Sand, Stone, Plastic Pellets)

FORK LIFT BAG FILLER BUCKETS			
FBF 600	Fork Lift Bag Filler Bucket		\$15,509.00
FBF 1000	Fork Lift Bag Filler Bucket		15,952.00
FBF 1400	Fork Lift Bag Filler Bucket		16,174.00
FBF WD	Weigh load system with digital display		3,656.00



PRICED IN CANADIAN DOLLARS

PRICES ARE FOB HARRISTON, ON – DESIGN & PRICE ARE SUBJECT TO CHANGE WITHOUT NOTICE



*PRO SLICE BRACKET PRICE INCREASE
 APRIL 1/25

GRAIN INDUSTRIAL HANDLING RANGE

ProDig Attachments

Product Code #	Description	Size	List Price [CDN]
STONE FORKS			
SF 1800	Stone Fork	1.8m	\$5,759.00
SF 2200	Stone Fork	2.2m	6,645.00
SF 2500	Stone Fork	2.5m	7,532.00
TBB 100	Tractor bolt on brackets		*571.00
IDBB 100	Industrial bolt on brackets		*799.00
TBB100-3PL-C2	3-point linkage/Euro 50 or Euro quicke combo (price does not include brackets)		1,718.00



MANURE FORKS			
MF 1800	Manure Fork	1.8m	\$4,429.00
MF 2200	Manure Fork	2.2m	5,094.00
MF 2500	Manure Fork	2.5m	5,759.00
TBB 100	Tractor bolt on brackets		*571.00
IBDD 100	Industrial bolt on brackets		*799.00
HX TIP	Replacement weld on hardox wear tips for tines (Price does not include brackets)	Each	39.00



PALLET FORKS			
PF 2000	Pallet Forks	2.5 tonne	\$1,992.00
PF 3000	Pallet Forks	3 tonne	2,346.00
PF 4900	Pallet Forks	5 tonne	3,764.00
PF 7000	Pallet Forks	7 tonne	6,645.00
PF 10000	Pallet Forks	10 tonne	10,634.00
PFSF 2-4.9	Bolt on spill frame (PF 2000 to PF4900)		765.00
PFSF 7-10	Bolt on spill frame (PF 7000 to PF10000) (Price includes weld on brackets)		920.00
PF-LG	Bolt on log grab (class 2&3)		2,759.00
PF-BS	Bolt on bale spike (class 2&3)		687.00

Price includes weld on brackets & forks



PRICED IN CANADIAN DOLLARS

PRICES ARE FOB HARRISTON, ON – DESIGN & PRICE ARE SUBJECT TO CHANGE WITHOUT NOTICE



*PRO SLICE BRACKET PRICE INCREASE
 APRIL 1/25

GRAIN INDUSTRIAL HANDLING RANGE

ProDig Attachments

Product Code #	Description	Size	List Price [CDN]
PRO SWEEP			
PS 2000	Pro Sweep	2.0m	\$2,878.00
PS 2500	Pro Sweep	2.5m	3,100.00
PFS 1250	Pro Sweep Pallet Fork Sleeves	1250mm	543.00
PFS 800	Pro Sweep Pallet Fork Sleeves	800mm	476.00
PS COM	Pro Sweep Combination Hitch/3-pt Linkage & Pallet Forks		1,108.00
PS DH	Pro Sweep Tractor/Industrial Loader Direct Hitch		609.00
PS SWIVEL	Pro Sweep Swivel Head-price does not include brackets		842.00
Pressure Relief Valve Kits			
3/8 PRV KIT	3/8" Pressure Relief Valve Kit	3/8"	\$299.00
1/2" PRV KIT	1/2" Pressure Relief Valve Kit	1/2"	355.00
TBB 100	Tractor bolt on brackets		*571.00
IDBB 100	Industrial bolt on brackets		*799.00
IDBB Custom	Custom/non-std bolt on brackets, 3-pt linkage, Terex 860, Skid Steer, JCB 3CX etc.		1,030.00
TB 100	Tractor weld-on brackets		321.00
IDB 100	Industrial weld-on brackets		521.00
HTBB 100	Industrial weld-on brackets for hi-tip bucket		1,042.00
BE 150x16	Cutting Edge – per metre	150 x 16	211.00
BE 150x20	Cutting Edge – per metre	150 x 20	233.00
BE 200x25	Cutting Edge – per metre	200 x 25	366.00
BE 200x30	Cutting Edge – per metre	250 x 30	543.00
Welded Brackets			
BOCE 200x25	Bolt on cutting edge – per metre	200 x 25	\$554.00
BOCE 250x30	Bolt on cutting edge – per metre	250 x 30	809.00
WOCE 200x25	Weld on cutting edge, welded to main edge - per metre	200 x 25	465.00
WOCE 250x30	Weld on cutting edge, welded to main edge - per metre	250 x 30	643.00



PRICED IN CANADIAN DOLLARS

PRICES ARE FOB HARRISTON, ON – DESIGN & PRICE ARE SUBJECT TO CHANGE WITHOUT NOTICE

TAB 1



5808 Hwy #9, Harriston, Ontario, N0G 1Z0
Phone: 519-338-2923, Fax: 519-338-2756
Email: sales@harcoag.ca
www.harcoag.ca

Date Change Only

Land Rollers

Single Section Rollers – Quarter Turn

Features Include:

- 42" diameter roller
- 5/8" nominal roller thickness for additional weight and for maximum durability
- Rugged construction weighs up to 450 lbs per foot without water for ballast
- 850 lb hitch weight

Standard Equipment:

- 2.5" removable roller shafts
- Highway speed rated 235x75R17.5 tires
- Transports under 9 feet
- 213 series bearings in ductile iron housings
- Clearance lights
- Acre metre

Optional Equipment:

- Levelling blade to smooth over animal mounds, irrigation tracks
- Water fill kit to add water ballast of additional 575 lbs per foot
- Valmar 4056 airseeding attachment – factory installed with step
- Tecknik Plus 12 volt air seeder attachment with rate controller

Model #	Description	Price [CDN]
800011	Single Section Quarter Turn Land Roller , 14 foot	\$32,600.00
803335	Ground Levelling Blade , 14 foot with hydraulic height	\$8,800.00
803310	Scraper Kit, 14 foot – Bolt on	\$1,050.00
Options		
803000	Water Fill Kit – 3" & 2" Banjo Quick Couplers	\$1,600.00
803022	Universal Seeder Mount Kit, Quarter Turn-No Seeder Quarter Turn Factory Set-Up	\$8,800.00 \$1,700.00

Disassembling Charge for Single Sections Rollers - \$450.00



PRICED IN CANADIAN DOLLARS

PRICES ARE FOB BENITO, MB – DESIGN & PRICE ARE SUBJECT TO CHANGE WITHOUT NOTICE



5808 Hwy #9, Harriston, Ontario, N0G 1Z0
Phone: 519-338-2923, Fax: 519-338-2756
Email: sales@harcoag.ca
www.harcoag.ca

Date Change Only

Land Rollers Continued...

Single Section Rollers – Straight Hitch

Features Include:

- 42" diameter roller
- 5/8" nominal roller thickness for additional weight and for maximum durability
- Rugged construction weighs up to 450 lbs per foot without water for ballast

Standard Equipment:

- 2.5" removable roller shafts
- Highway speed rated 235x70R16 tires
- Transports 1 foot wider than working width
- 213 series bearings in ductile iron housings
- Clearance lights
- Acre metre

Optional Equipment:

- Levelling blade to smooth over animal mounds, irrigation tracks
- Water fill kit to add water ballast of additional 575 lbs per foot
- Valmar 4056 airseeding attachment – factory installed with step
- Technik Plus 12 volt air seeder attachment with rate controller

Model #	Description	Price [CDN]
800004	Single Section Land Roller , 11.5 foot	\$20,400.00
805015	Ground Levelling Blade , 11.5 foot with hydraulic height	\$7,500.00
800007	Scraper Kit, 11.5 foot – Bolt on	\$950.00
<hr/>		
800003	Single Section Land Roller , 14 foot	\$23,500.00
803335	Ground Levelling Blade , 14 foot with hydraulic height	\$8,800.00
804640	Scraper Kit, 14 foot – Bolt on	\$1,050.00
<hr/>		
800005	Single Section Land Roller , 17 foot	\$24,500.00
805001	Ground Levelling Blade , 17 foot with hydraulic height	\$9,500.00
804286	Scraper Kit, 17 foot – Bolt on	\$1,150.00
<hr/>		
800002	Single Section Land Roller , 20 foot	\$27,600.00
805356	Ground Levelling Blade , 20 foot with hydraulic height	\$10,600.00
804647	Scraper Kit, 20 foot – Bolt on	\$1,250.00
<hr/>		
Options		
803000	Water Fill Kit – 3" & 2" Banjo Quick Couplers	\$1,600.00
<hr/>		
	Single Section Factory Set-Up	\$1,400.00

Disassembling Charge for Single Sections Rollers - \$450.00



PRICED IN CANADIAN DOLLARS

PRICES ARE FOB BENITO, MB – DESIGN & PRICE ARE SUBJECT TO CHANGE WITHOUT NOTICE



5808 Hwy #9, Harriston, Ontario, N0G 1Z0
Phone: 519-338-2923, Fax: 519-338-2756
Email: sales@harcoag.ca
www.harcoag.ca

Date Change Only

Land Rollers Continued...

Three Section Rollers

Features Include:

- 42" diameter roller
- 5/8" nominal roller thickness for additional weight and for maximum durability
- Rugged construction weighs up to 450 lbs per foot without water for ballast

Standard Equipment:

- 2.5" removable roller shafts
- Highway speed rated 235x70R16 tires
- Patented diagonal brace arm
- Hydraulic floating hitch
- 213 series bearings in ductile iron housings
- Clearance lights
- Acre metre
- Hydraulic folding rear wheels

Optional Equipment:

- Levelling blade to smooth over animal mounds, irrigation tracks
- Water fill kit to add water ballast of additional 575 lbs per foot
- Valmar 4056 or 6056 airseeding attachment – factory installed with step

Model #	Description	Price [CDN]
800020	3 Section Land Roller , 31 foot	\$63,050.00
805007	Ground Levelling Blade , 31 foot with hydraulic height	\$21,800.00
802446	Scraper Kit, 31 foot – Bolt on	\$2,500.00
800009	3 Section Land Roller , 36 foot	\$66,500.00
805010	Ground Levelling Blade , 36 foot with hydraulic height	\$23,000.00
802447	Scraper Kit, 36 foot – Bolt on	\$2,800.00
800010	3 Section Land Roller , 42 foot	\$68,800.00
805011	Ground Levelling Blade , 42 foot with hydraulic height	\$24,900.00
802448	Scraper Kit, 42 foot – Bolt on	\$3,100.00
800018	3 Section Land Roller , 46 foot	\$73,200.00
805006	Ground Levelling Blade , 46 foot with hydraulic height	\$26,150.00
802449	Scraper Kit, 46 foot – Bolt on	\$3,450.00
800017	3 Section Land Roller , 52 foot	\$81,800.00
805012	Ground Levelling Blade , 52 foot with hydraulic height	\$27,600.00
802450	Scraper Kit, 52 foot – Bolt on	\$3,760.00
Options		
803040	Water Fill Kit – 3" & 2" Banjo Quick Couplers	\$5,400.00
803024	Universal Seeder Mount Kit, 3 Section – No Seeder	\$10,150.00
		3-Section Factory Set-Up
		\$2,300.00

Disassembling Charge for Single Sections Rollers - \$450.00



PRICED IN CANADIAN DOLLARS

PRICES ARE FOB BENITO, MB – DESIGN & PRICE ARE SUBJECT TO CHANGE WITHOUT NOTICE



5808 Hwy #9, Harriston, Ontario, N0G 1Z0
Phone: 519-338-2923, Fax: 519-338-2756
Email: sales@harcoag.ca
www.harcoag.ca

Date Change Only

Land Rollers Continued...

Three Section Rollers – Extreme Duty

Features Include:

- 42” diameter roller
- 21mm (almost 7/8”) nominal roller thickness for additional weight and for maximum durability
- Rugged construction weighs up to 570 lbs per foot without water for ballast

Standard Equipment:

- 2 15/16” removable roller shafts
- Highway speed rated 235x70R16 tires
- Patented diagonal brace arm
- Hydraulic floating hitch
- Double Row Spherical Bearings
- Clearance lights
- Acre metre
- Hydraulic folding rear wheels

Optional Equipment:

- Water fill kit to add water ballast of additional 575 lbs per foot

Model #	Description	Price [CDN]
875046	3 Section Land Roller , 46 foot	\$83,400.00
875052	3 Section Land Roller , 52 foot	\$91,800.00
	3 Section Factory Setup	\$2,650.00
Please contact for current freight quote		



Disassembling Charge for Single Sections Rollers - \$450.00

PRICED IN CANADIAN DOLLARS

PRICES ARE FOB BENITO, MB – DESIGN & PRICE ARE SUBJECT TO CHANGE WITHOUT NOTICE



Date Change Only

Land Rollers Continued...

Five Section Rollers

Features Include:

- 42" diameter roller
- 5/8" nominal roller thickness for additional weight and for maximum durability
- Rugged construction weighs up to 450 lbs per foot without water for ballast

Standard Equipment:

- 2.5" removable roller shafts
- Highway speed rated 235x70R16 tires
- Patented diagonal brace arm
- Hydraulic floating hitch
- 213 series bearings in ductile iron housings
- Clearance lights
- Acre metre
- Hydraulic folding wheels

Model #	Description	Price [CDN]
800056	12-56-5, 5 Section Land Roller, 56 foot	\$105,900.00
800062	12-62-5, 5 Section Land Roller, 62 foot	\$109,900.00
800066	12-66-5, 5 Section Land Roller, 66 foot	\$114,900.00
800070	12-70-5, 5 Section Land Roller, 70 foot	\$120,900.00
	5 Section Factory Set Up	\$4,000.00



Disassembling Charge for Single Sections Rollers - \$450.00

PRICED IN CANADIAN DOLLARS

PRICES ARE FOB BENITO, MB – DESIGN & PRICE ARE SUBJECT TO CHANGE WITHOUT NOTICE

5808 Hwy #9, Harriston, Ontario, N0G 1Z0
Phone: 519-338-2923, Fax: 519-338-2756
Email: sales@harcoag.ca
www.harcoag.ca







New vertical tillage concept by HCC Inc. features patented self sharpening tines in a three tine configuration followed by adjustable rolling harrows.

Unit can be purchased less the rolling harrows. Machines with harrows can be operated with harrows lifted or with varying rates of penetration and different angles allowing for varying finish results.

Extremely heavy frame and tongue provide excellent downward pressure. At the same time the rolling aerator tines are protected from impact by 'C' shanks.

Dual wheels are standard on all machines.

SMART-TILL				
Model	Width	Weight (lbs)	Set Up	MSRP [USD]
SMT 101	10 Feet Less Rolling Harrows	3,350	\$200.00	\$31,540.00
SMT 101	10 Feet With Rolling Harrows	5,250	\$350.00	\$39,710.00
SMT 151	15 Feet Less Rolling Harrows	5,000	\$350.00	\$44,410.00
SMT 151	15 Feet With Rolling Harrows	7,850	\$400.00	\$57,335.00
SMT 203	20 Feet Less Rolling Harrows	7,550		\$61,905.00
SMT 203	20 Feet With Rolling Harrows	11,500		\$85,465.00
SMT 303	30 Feet Less Rolling Harrows	10,500		\$97,425.00
SMT 303	30 Feet With Rolling Harrows	16,500		\$120,345.00

PRICED IN USD - ITEMS MAY BE SUBJECT TO A POTENTIAL TARIFF CHARGE
FOB FACTORY – PRICES SUBJECT TO CHANGE WITHOUT NOTICE

5808 Hwy #9, Harriston, Ontario, N0G 1Z0
Phone: 519-338-2923, Fax: 519-338-2756
Email: sales@harcoag.ca
www.harcoag.ca



Rotary Harrows Modules

Part #	Description	MSRP [USD]
853044	Harrow Module – 3'	\$2,435.00
853066	Harrow Module – 5' 7"	\$2,985.00
853033	Harrow Module – 6'	\$3,115.00
853109	Harrow Module – 9'	\$4,080.00

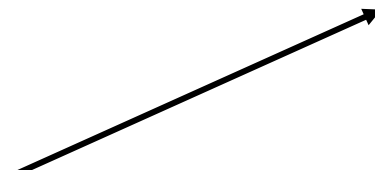

Harrow Hangers

Part #	Description	MSRP [USD]
853129*	3' Harrow Hanger	\$555.00
853103*	5' 7", 6', 9' Harrow Hanger	\$660.00

Harrows smooth, level & loosen soil – Ideal for seed bed preparation. Harrows can be varied up to 30° at either standard or aggressive angles. Tine material is wear resistant 4140 steel.

*Includes hanger, bushing & decal.

PRICED IN USD - ITEMS MAY BE SUBJECT TO A POTENTIAL TARIFF CHARGE
FOB FACTORY – PRICES SUBJECT TO CHANGE WITHOUT NOTICE

ITEMS MAY BE SUBJECT TO A POTENTIAL TARIFF CHARGE

SCHMEISER®

WHOLEGOODS PRICE CATALOG



SELMA, CA



1-800 288-8128 Order Desk

559-268-3279 Fax
orders@tgschmeiser.com

www.tgschmeiser.com

JANUARY 2026

Version 17.0

SWGPC260115

T. G. SCHMEISER CO., INC.**TERMS & CONDITIONS OF SALE**

Minimum Order: \$50.00 Net

Freight: F.O.B. Factory

Prices: Subject to change without notice. All shipments will be at prevailing prices on the date of order.

Ordering Policy:

- 1 **Wholegoods** - All wholegood orders will be confirmed back to customer by order acknowledgement via fax or email. All orders will be built according to the written order acknowledgement. If the order acknowledgement is incorrect, call immediately to correct the order. If, after ordering, you have not received an acknowledgement, your order may not have been booked. Please call our office to confirm your order.
- 2 **Parts** - Most parts ship out the same day if orders are placed by 2:00 p.m. All parts will be shipped out via UPS (prepaid and add) or truckline (freight collect) unless otherwise noted. No order acknowledgement will be sent unless requested. If account is not current, then the order will be shipped C.O.D.

Order Changes: Wholegood orders changed or modified after production has begun may incur a change charge.

Knocked Down or Assembled: Our products are shipped "knocked down". This simply means that our wholegood products are disassembled enough to safely fit on a truck (flatbed). The pricelist will indicate assembly charges for each product line. If you wish to have your order completely assembled, a net charge will apply.

Return Policy: No product or part may be returned for credit unless written authorization by T.G. Schmeiser Co., Inc. has been given in advance. All returned items must have an RMA (Return Material Authorization) number clearly written on the packing list and on the exterior of package. If an item does not have an RMA number, shipment will not be accepted and credit will not be given. All returned items must be shipped prepaid.

- 1 **Wholegoods** - Wholegood items that are standard built may be returned for credit with advanced written authorization. Items shall be new and in unused condition.
Many wholegoods are custom built or special order items.
These are either non-returnable or subject to a re-stocking charge, depending on how specialized the order.
- 2 **Parts** - All parts that have been ordered within the last 12 months (and are listed in the current parts price list) may be returned for credit. Parts shall be new and in unused condition. Items that are obsolete or superseded may be returned, only if listed on current parts pricelist.

Past Due Accounts: Accounts past due will be placed on C.O.D. or hold until brought current or satisfactory arrangements are made for payment. Interest of 1-1/2% per month (annual rate 18%), or such other rate allowed by state law, can be charged on past due accounts.

Damages or Shortages in Shipping: We make every effort to see that equipment and/or parts are loaded on the carrier's vehicle properly, however the ultimate responsibility of securing load and transportation is that of the carrier. T.G. Schmeiser Co. is not liable for damage or loss of merchandise once it has left our yard. Dealer is solely responsible for filing claims against the carrier for any loss or damage. Schmeiser will help you in securing an adjustment for the loss or damage, providing you have filed a claim with the carrier. Claims for shortages in shipments or concealed damage must be made within 10 days of receipt of goods.

Warranty: All Wholegood items are subject to the Schmeiser 12 month **Limited Written Warranty**. Warranty cards must be submitted within 30 days of sale to retail customer to be eligible. All warranty work must be pre-approved. Schmeiser/Dealer warranty policy is available by calling the factory.

T.G. Schmeiser reserves the right to make improvements in the design and changes in specifications at any time without incurring any obligation to install them on units previously sold.

SCHMEISER® PRICE LIST

CONTENTS

TERMS AND CONDITIONS	Page	2
TILL AN' PAK™	Till an' Pak	Pages	4 - 8
	Smooth an' Roll		
	Float		
	Squadron Arms		
	3pt. Hitches		
	TPP 3510 Wheel Kit		
	TPP 3520 Wheel Kit		
	TPP 3530 Wheel Kit		
	TPP 3540 Wheel Kit		
	TPP 3550 Wheel Kit		
	Folding Till an' Paks		
AERATION & SOIL MGT.	Smart-Till®	Pages	9 - 10
	Smart-Till® ORCHARD MAX		
TILL AN' BEDDER™	4 Bar Till an' Bedder	Pages	11 - 12
	4 Bar Folding Till an Bedder		
LEVELERS	Drag Scraper		13 - 20
	Speed Leveler		
	V-Blade		
	Bantam Leveler		
	Model 77 Leveler		
	Varitrak 3pt. Land Leveler		
	Grader Blade		
	Tri-Plane Land Leveler		
	Folding Tri-Plane Land Leveler		
	Precision Finishing Scraper		
RIPPERS	Finishing Ripper Chisel	Pages	21 - 28
	S-Series		
	C-Series		
	P-Series		
	Crumbler		
	Down Pressure Roller		
	V-Series		
	Mid-Row Ripper		
3PT. CULTI-PLOW™ (Chisel Plow)	2 Bar	Page	29
	3 Bar		
DISC - TANDEM	ORCHARD DISC	Pages	30 - 35
	TSN - 3pt.		
	RTM - 3pt.		
	RTH - 3pt.		
	PTM - Pull Type		
	PTH - Pull Type		
DRILLS - COVER CROP	Double Disc Model	Page	36
	No-Till Drill		
HARVEST BIN TRAILERS	Page	37
CONTACT INFORMATION	Page	40

MODEL 77 TILL AN' PAK™ PRICE LIST



TILL AN' PAK™

Assembly charge - n/c Assembled - except tongue

TONGUES			3 X 52"					3 X 72"			3 X 84"			
TUBE	RING	WT/FT	2 FT	3 FT	4 FT	5 FT	6 FT	7 FT	8 FT	9 FT	10 FT	11 FT	12 FT	
8	10/14	114	\$ 2,620	\$ 2,950	\$ 3,270	\$ 3,605	\$ 4,055	\$ 4,390	\$ 4,720	\$ 5,015	\$ 5,640	\$ 5,975	\$ 6,305	
8	12/16	137	3,030	3,375	3,700	4,015	4,510	4,830	5,165	5,475	6,110	6,460	6,760	
8	13/17	150	3,005	3,320	3,645	3,970	4,430	4,765	5,085	5,400	6,025	6,340	6,660	
8	14/20	212	3,215	3,340	4,175	4,660	5,270	5,765	6,250	6,730	7,445	8,005	8,415	
8	16/22	221	3,380	3,955	4,550	5,125	5,840	6,420	7,020	7,590	8,495	9,085	9,660	
10	12/16	143	3,095	3,435	3,785	4,130	4,605	4,950	5,295	5,640	6,275	6,770	6,960	
10	13/17	157	3,060	3,390	3,725	4,065	4,550	4,870	5,215	5,555	6,180	6,520	6,850	
10	14/20	219	3,240	3,750	4,250	4,750	5,380	5,875	6,375	6,880	7,675	8,180	8,660	
10	16/22	228	3,430	4,010	4,630	5,165	5,920	6,495	7,080	7,690	8,560	9,230	9,765	
12	14/20	224	3,275	3,795	4,310	4,810	5,460	5,970	6,485	6,980	7,865	8,325	8,850	
12	16/22	233	3,470	4,075	4,685	5,235	6,040	6,615	7,230	7,840	8,710	9,395	9,920	
14	16/22	236	3,555	4,180	4,805	5,350	6,165	6,770	7,390	8,010	8,880	9,575	10,085	

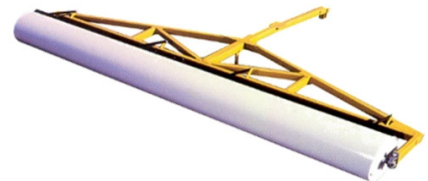

SMOOTH AN' ROLL™

Assembly charge - n/c Assembled - except tongue

	20"	114	\$ 2,305	\$ 2,485	\$ 2,660	\$ 2,970	\$ 3,280	\$ 3,465	\$ 3,715	\$ 3,840	\$ 4,135	\$ 4,415	\$ 4,595
	24"	135	2,535	2,765	2,970	3,350	3,700	3,920	4,155	4,435	4,820	5,050	5,280
	30"	166	3,005	3,425	3,825	4,435	4,990	5,405	5,820	6,255	6,875	7,300	7,730
	36"	182	CALL FOR PRICING										
Mud Scraper	5	115	130	135	145	165	170	180	215	220	230	245	

(Call For Availability)



FLOAT

Assembly charge - n/c Minimal assembly required

	24	1,155	1,215	1,275	1,330	1,410	1,465	1,510	1,620	1,665	1,715	1,825
--	----	-------	-------	-------	-------	-------	-------	-------	-------	-------	-------	-------



SQUADRON ARMS (PAIR)

Assembly charge - n/c Minimal assembly required

Size	12"	18"	24"	30"	36"	42"	48"	54"	60"	66"	72"
T-P Trail Unit Width	2 FT	3 FT	4 FT	5 FT	6 FT	7 FT	8 FT	9 FT	10 FT	11 FT	12 FT
Price	1,380	1,415	1,545	1,575	1,610	1,630	1,755	1,780	1,815	1,885	1,930
Weight	103	109	115	121	151	160	169	178	187	196	205

MODEL 77 TILL AN' PAK™ PRICE LIST



TILL AN' PAK™

Assembly charge - n/c Assembled - except tongue

			← 3-1/2 X 84" →					← 3-1/2 X 100" →						
TUBE	RING	WT/FT	13 FT	14 FT	15 FT	16 FT	17 FT	18 FT	19 FT	20 FT	21 FT	22 FT	23 FT	24 FT
8	10/14	114	\$ 6,430	\$ 7,155	\$ 7,575	\$ 8,045	\$ 8,375	\$ 8,455	\$ 9,385	\$ 9,890	\$ 10,610	\$ 10,810	\$ 11,340	\$ 11,680
8	12/16	137	6,455	7,195	7,590	8,180	8,495	8,535	9,485	10,000	10,700	10,985	11,375	11,725
8	13/17	150	6,675	7,450	7,860	8,415	8,670	8,725	9,710	10,205	11,000	11,320	11,710	12,040
8	14/20	212	8,715	9,620	10,190	10,855	11,395	11,800	12,660	13,350	14,280	14,770	15,310	15,795
8	16/22	221	9,965	10,960	11,615	12,345	12,950	13,510	14,465	15,270	16,275	16,860	17,495	18,080
10	12/16	143	7,155	7,300	7,695	8,185	8,495	8,810	9,520	10,010	10,785	11,095	11,475	11,800
10	13/17	157	7,510	7,655	8,080	8,490	8,665	9,250	9,995	10,495	11,305	11,645	11,890	12,390
10	14/20	219	8,915	9,835	10,145	11,075	11,230	12,065	12,945	13,645	14,185	15,070	15,645	16,140
10	16/22	228	10,155	11,160	11,820	12,585	12,785	13,765	15,150	15,540	16,565	17,155	17,815	18,405
12	14/20	224	9,085	10,015	10,610	11,290	11,450	12,295	13,190	13,900	14,845	15,365	15,945	16,455
12	16/22	233	10,340	11,365	12,045	12,810	13,025	14,025	15,000	15,825	16,860	17,300	18,135	18,735
14	16/22	236	10,550	11,585	12,145	13,450	13,275	14,290	15,280	16,110	17,160	17,700	18,460	19,085

** 2-3/16" Pillow Block Bearing Upgrade	\$390
TPP3700 - Bolt on Jack Stand	\$195



SMOOTH AN' ROLL™

Assembly charge - n/c Assembled - except tongue

	20"	114	\$ 4,595	\$ 5,160	\$ 5,425	\$ 5,760	\$ 5,935	\$ 5,970	\$ 6,645	\$ 6,955	\$ 7,540	\$ 7,720	\$ 7,955	\$ 8,160
	24"	135	5,295	5,910	6,205	6,525	6,690	6,975	7,555	7,905	8,515	8,750	9,045	9,130
	30"	166	7,835	8,625	9,035	9,680	10,090	10,500	11,255	11,790	12,590	13,005	13,490	13,905
	36"	182	CALL FOR PRICING											
Mud Scraper	5	275	285	295	310	320	345	350	360	375	390	400	405	

(Call For Availability)



FLOAT

Assembly charge - n/c Minimal assembly required

	24	1,900	1,965	2,020	2,080	n/a	n/a	n/a	n/a	n/a	n/a	n/a	n/a	n/a
--	----	-------	-------	-------	-------	-----	-----	-----	-----	-----	-----	-----	-----	-----

FOLDING TILL AN' PAK - See Page #8



1 800 288-8128 Order Desk

TILL AN' PAK WHEEL KIT PRICE LIST

TPP 3510, TPP 3520 and TPP 3530



TPP 3520 (end mount)



TPP 3510 (vineyard model)

**Jack Stand and Safety Chain standard
Light kit included on units 12' and
wider**

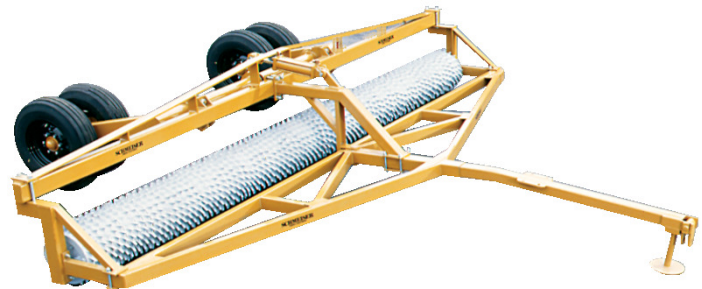

TPP 3530 Model

HYDRAULIC WHEEL KITS & MISC. ATTACHMENTS

Assembly Charge: n/c

PART NO.	DESCRIPTION	WT.	PRICE
TPP 3501	3 Pt. Hitch Cat 1 & 2 (2 - 13 ft.)	80 lbs.	\$ 1,125.00
TPP 3502	3 Pt. Hitch Cat 2 & 3 (14 - 20 ft.) (Specify Width)	105	1,530.00
TPP 3503	Implement Trail Hitch	81	918.00
TPP 3510	*1Hydraulic Transport Kit up to 10 ft. (Less Tires & Lead Hoses)	350	4,035.00
TPP 3520	¹ Hydraulic Transport Kit (End Mount) up to 14 ft. (Less Tires & Lead Hoses)	282	3,970.00
TPP 3530-2	Hydraulic Transport Kit (8 - 16 ft.) - 2 Wheels (Less Tires & Lead Hoses)	875	6,125.00
TPP 3530-4	Hydraulic Transport Kit (14 - 24 ft.) - 4 Wheels (Less Tires & Lead Hoses)	950	7,290.00
7.60x15 TIRE	7.60 x 15 Rib Implement Tires (Mounted) - Each	25	225.00

*Can not use 10" tube with 14/20 ring combination. ¹Up to 12" tube and 14/20 ring.

LEAD HOSES (with pioneer tips)

PART NO.	DESCRIPTION	LENGTH	TPP 3510	TPP 3520	TPP 3530	FOLDING T-F	WT.	PRICE
LH-100	Lead Hoses - pair	100"		2' - 5'			15 lbs.	\$ 175.00
LH-112	Lead Hoses - pair	112"	2' - 5'	6' - 9'			16	180.00
LH-120	Lead Hoses - pair	120"		10' - 14'			17	190.00
LH-132	Lead Hoses - pair	132"	6' - 9'		8' - 9'		18	205.00
LH-144	Lead Hoses - pair	144"	10'		10' - 18'		19	210.00
LH-168	Lead Hoses - pair	168"			19' - 24'		20	245.00
LH-204	Lead Hoses - pair	204"					25	295.00

TILL AN' PAK WHEEL KIT PRICE LIST

TPP 3540 and TPP 3550

Jack Stand and Safety Chain standard
Light kit included on units 12' and wider



TPP 3540 WHEEL KIT (ADJUSTABLE)

Assembly charge - n/c assembled except pull frame

PART NO.	DESCRIPTION	WT.	PRICE
TPP 3540-2	Adjustable Wheel Kit (8 - 16 ft.) - 2 Wheels (Less Tires & Lead Hoses)	1,200 lbs.	\$ 6,515.00
TPP 3540-4	Adjustable Wheel Kit (14 - 20 ft.) - 4 Wheels (Less Tires & Lead Hoses)	1,500	7,990.00
TPP 3540-4HD	Adjustable Wheel Kit (18 - 24 ft.) - 4 Wheels Heavy Duty- For Lrg Rings	1,800	9,065.00
7.60X15TIRE	7.60 x 15 Rib Implement Tires (Mounted) - Each	25	225.00
TPP 3540-GN	3540 Gooseneck Hitch - (1) Cylinder		2,480.00
TPP 3540-GNHD	3540 Gooseneck Hitch - Heavy Duty - (2) Cylinder		2,765.00
TPP 3540-GNHDXL	3540 Gooseneck Hitch - Heavy Duty - 2 Cylinder - X-Large	2,680	3,770.00

TPP 3540 Adjustable Wheel Kit sold only with Till An' Pak.
 Add price of Wheel Kit to price of Till An' Pak for total unit price. See page #5 for Till an' Pak prices.



TPP 3550 WHEEL KIT (STRADDLE AXLE)

Assembly charge - n/c

Transport width - 5'-7"

	18 FT	19 FT	20 FT	21 FT	22 FT	23 FT	24 FT	25 FT	26 FT	27 FT	28 FT	29 FT
Kit Price	\$11,955	12,025	12,080	12,155	12,210	12,290	12,345	12,415	12,480	12,550	12,605	12,690
add'l weight	1,650	1,685	1,720	1,755	1,790	1,825	1,860	1,895	1,930	1,965	2,000	2,035

Includes (2) tires & cylinder. Lead hoses not included.
 TPP 3550 Adjustable Wheel Kit sold only with Till An' Pak. All sizes use 2-3/16" flange bearings.
 Add price of Wheel Kit to price of Till An' Pak for total unit price. See page #5 for Till an' Pak prices.

LEAD HOSES (with pioneer tips)

PART NO.	DESCRIPTION	LENGTH	TPP 3540	TPP 3550	FOLDING T-P	WT.	PRICE
LH-112	Lead Hoses - pair	112"	8' - 9'			16 lbs.	\$ 180.00
LH-120	Lead Hoses - pair	120"	10' - 18'			17	190.00
LH-132	Lead Hoses - pair	132"	19' - 24'			18	205.00
LH-204	Lead Hoses - pair	204"				25	295.00
LH-216	Lead Hoses - pair	216"		18' - 21'	ALL SIZES	27	305.00
LH-240	Lead Hoses - pair	240"		22' - 25'		30	330.00
LH-260	Lead Hoses - pair	260"		26' - 28'		35	345.00
LH-275	Lead Hoses - pair	275"		29' - 30'		40	420.00

MODEL 77 TILL AN' PAK PRICELIST

FOLDING MODEL



- 2-3/16" bearings & 6" overlap standard
- Call factory for narrower transport widths and Folding Smooth an' Roll

Assembly charge - \$ 250 net



TUBE	RING	WT/FT	20 FT	21 FT	22 FT	23 FT	24 FT	25 FT	26 FT	27 FT	28 FT
12	14/20	360	40,205	40,845	41,280	42,020	42,635	43,080	43,665	44,290	44,875
14	16/22	380	43,870	44,435	45,025	45,745	46,175	46,905	47,770	48,360	49,120

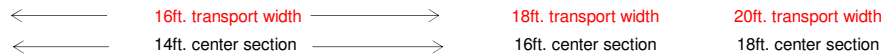

TUBE	RING	WT/FT	-	29 FT	30 FT	31 FT	32 FT	33 FT	34 FT	35 FT	36 FT
12	14/20	360	-	46,255	46,985	47,295	48,100	48,835	49,270	49,860	50,240
14	16/22	380	-	50,530	51,335	52,065	52,645	53,360	54,100	54,670	55,295

Includes transport & folding hydraulics; (4) tires, cylinders, valves and connecting hoses.
2-3/16" Bearings and 6" Overlap are now standard - Lead hoses not included.

Folding Till an' Pak Options

PART NO.	DESCRIPTION	PRICE
FTP-GN	FTP Gooseneck Hitch - (1) Cylinder	\$ 2,345.00
FTP-GNHD	FTP Gooseneck Hitch - Heavy Duty - (2) Cylinders	2,650.00
FTP-GNHDXL	FTP Gooseneck Hitch - Heavy Duty - (2) Cylinders - X-Large	3,405.00
FTP-TWB	Tandem Walking Beams - Heavy Duty	1,990.00
LH-216	Lead Hoses & Tips (pair)	305.00
LH-275	Gooseneck Lead Hoses & Tips (pair)	420.00

3 PT. FOLDING SMOOTH AN' ROLL



- Unit features 2-3/16" bearings & 6" overlap between wing and main frame rollers
- CAT 3 (QH) / CAT 4N (QH) / CAT 4 Compatible
- Flow divider for uniform wing movement
- Mud-Scrapers included

MODEL	WIDTH	TUBE DIAMETER	WEIGHT	PRICE
SRF3P4024	40 FT.	24"	8,200 LBS.	\$31,715.00

AERATION & SOIL MANAGEMENT

SCHMEISER SMART-TILL®



SMART-TILL

Visit www.smart-till.com for more information

MODEL NO.	TILLED WIDTH	RIGID -FOLDING	TRANSPORT WIDTH	APPROX. HP	WEIGHT	PRICE W/ HARROWS	PRICE W/O HARROWS
SMT101	10 ft.	RIGID	12'	85-130 PTO	3,350 lbs. w/o harrows 5,250 lbs. w/ harrows	\$ 39,710.00	\$ 31,540.00
SMT151	15 ft.	RIGID	17'	130-200 PTO	5,000 lbs. w/o harrows 7,850 lbs. w/ harrows	57,335.00	44,410.00
SMT203	20 ft.	FOLDING	17'	170-255 PTO	7,550 lbs. w/o harrows 11,400 lbs. w/ harrows	85,465.00	61,905.00
SMT303	30 ft.	FOLDING	17'	300-450 ENGINE 255-380 PTO	10,500 lbs. w/o harrows 16,000 lbs. w/ harrows	120,345.00	97,425.00

- 2.7" TILL XTREME trunnion bearings standard on tine gangs Transport width is **with** rear harrows.
 - Tires & lead hoses are included.



SMART-TILL ROTARY HARROW MODULES

PART NO.	DESCRIPTION	Field Width (tine to tine)		PRICE
		0° Angle	30° Angle	
853044	Harrow Module 3'	38"	33"	\$ 2,435.00
853066	Harrow Module 5'7"	68"	59"	2,985.00
853033	Harrow Module 6'		63.5"	3,115.00
853109	Harrow Module 9'	115"	100"	4,080.00
853129*	3' Harrow Hanger			555.00
853103*	5'7", 6', 9' Harrow Hanger			660.00

- Harrows smooth, level and loosen soil - Ideal for seed bed preparation. Harrows can be varied up to 30° at either standard or aggressive angles. Tine material is wear resistant 4140 steel. *includes: hanger, bushing, and decal

1 800 288-8128 Order Desk

AERATOR PRICE LIST SMART-TILL ORCHARD MAX



Optional Rear Rollers



STO-14 - 14' Wide Unit

SMART-TILL ORCHARD MAX

Assembly charge - N/A

MODEL NO.	SIZE	Working Width	Overall Width	WEIGHT	PRICE
STO-08	8 ft.	4' - 8'	9'	1,600	\$ 11,480.00
STO-09	9 ft.	5' - 9'	10'	1,650	11,550.00
STO-10	10 ft.	6' - 10'	11'	1,700	11,625.00
STO-11	11 ft.	7' - 11'	12'	1,750	11,700.00
STO-12	12 ft.	8' - 12'	13'	1,800	11,775.00
STO-13	13 ft.	9' - 13'	14'	1,850	11,850.00
STO-14	14 ft.	10' - 14'	15'	1,900	11,925.00
STO-15	15 ft.	11' - 15'	16'	1,950	11,995.00

Standard Accessories: Patented Smart-Till Chrome Tines, 2.7" Sealed Till XTreme Bearings, Light kit on units 12' and wider, Adjustable gangs from 0-10 degrees, Bearing guards & weight brackets

OPTIONS / PARTS

PART NO.	DESCRIPTION	PRICE
*NO PART NUMBER	Make unit adjustable by 2' less than overall size (i.e. 14' to 12')	\$ 250.00
GMB-WEIGHT	100 LB. Suitcase Weight (Up to 20 per machine)	145.00
TP02101216D-6SR	2' - 6" Wide - 10-12/16 Rear Roller	EA. 3,015.00

ORDERS@TGSCHMEISER.COM

TILL AN' BEDDER™ PRICE LIST

NEXT GEN RIGID TILL AN' BEDDER

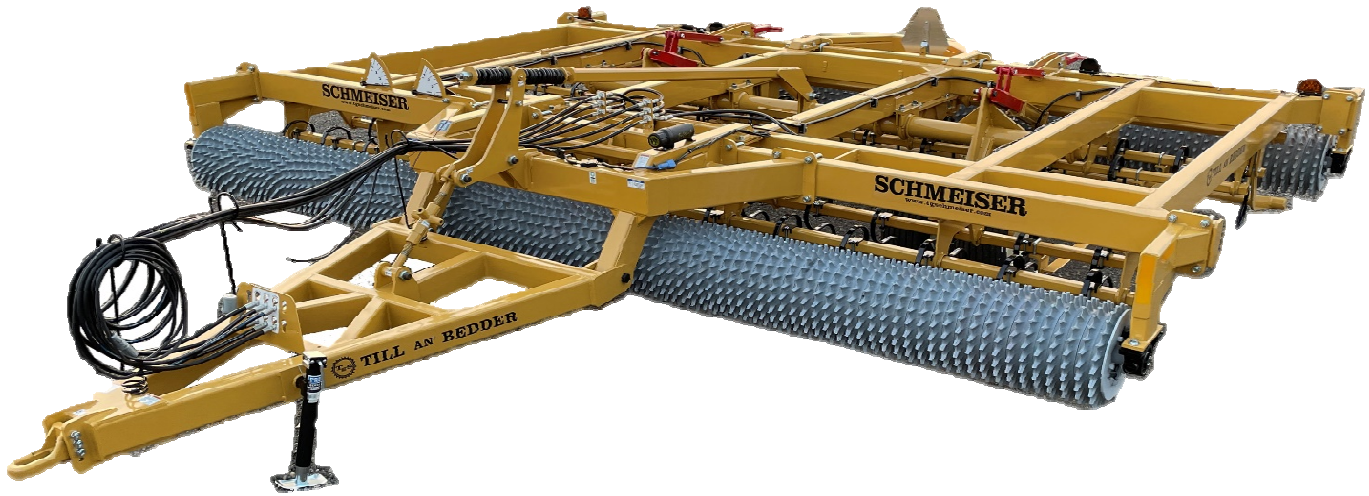

FOUR BAR MODEL
 Assembly charge - \$ 300 net

Width	Tube-Ring Size	Model Number	WT.	Transport Width	Approx. HP	PRICE
12 ft.	12 - 14/20	TBX412121420D	9,475	13' - 8"	120 - 180	48,315.00
12 ft.	14 - 16/22	TBX412141622D	9,775	13' - 8"	120 - 180	48,980.00
14 ft.	12 - 14/20	TBX414121420D	11,100	15' - 8"	140 - 210	52,225.00
14 ft.	14 - 16/22	TBX414141622D	11,435	15' - 8"	140 - 210	53,105.00
16 ft.	12 - 14/20	TBX416121420D	12,580	17' - 8"	160 - 240	58,235.00
16 ft.	14 - 16/22	TBX416141622D	12,980	17' - 8"	160 - 240	59,240.00
18 ft.	12 - 14/20	TBX418121420D	14,490	19' - 8"	180 - 270	64,585.00
18 ft.	14 - 16/22	TBX418141622D	14,940	19' - 8"	180 - 270	65,400.00
20 ft.	12 - 14/20	TBX420121420D	16,100	21' - 8"	200 - 300	69,720.00
20 ft.	14 - 16/22	TBX420141622D	16,600	21' - 8"	200 - 300	70,975.00

Next Gen Model includes 2-11/16" Till Xtreme Bearings. Hydraulic S-Tines Standard. Depth gauge for S-Tines & Leveling bar standard.
 1 Foot wider rear roller standard. Ductile Rings standard. All lead hoses and wheels and tires included. Easy to adjust front-to-rear level.
 On board hose storage. Light Kit Included. Unit ships 11'11" wide & 85% assembled.



OPTIONAL REAR TRAIL HITCH

TILL AN' BEDDER OPTIONS

PART NO.	DESCRIPTION	WT.	PRICE
TBX4-Q	Heavy Duty Rear Trail Hitch		1795.00
HKFTB4-TH	Hose kit for Heavy Duty Rear Trail Hitch hydraulic circuit (1 pair)		575.00
SBM-SRO	Front Split Roller Option (for 12ft. to 20ft. units)		2050.00

Light kit included on all units

ORDERS@TGSCHMEISER.COM

TILL AN' BEDDER™ PRICE LIST

NEXT GEN FOLDING TILL AN' BEDDER

(4 BAR MODEL)



FOLDING 4 BAR TILL AN' BEDDER

Assembly charge - \$ 600 net - ready to tow

Width	Tube-Ring Size	Model Number	Transport Width	Approx. HP	PRICE
24 FT.	14-16/22	TBFX424141622D	17' 6"	240 - 360	118,060.00
26 FT.	14-16/22	TBFX426141622D		260 - 390	122,650.00
28 FT.	14-16/22	TBFX428141622D		280 - 420	128,030.00
30 FT.	12-14/20	TBFX430121420D		300 - 450	128,460.00
30 FT.	14-16/22	TBFX430141622D			132,970.00
30 FT.	14/24S 14/20D	TBFX430121420DS			129,105.00
30 FT.	14/24S 16/22D	TBFX430141622DS			132,970.00

Hydraulic S-Tine Kit Standard. Depth indicator for S-Tines and Leveling Bar Standard. Front to rear level standard. Front hydraulic hose storage bank. Includes tires and all hydraulic cylinders and connecting hoses. Call factory for pricing on other sized units.

Units ship partially assembled 11' 11" wide. Estimated assembly time at dealership is (2) personnel @ 8 hours each.

TILL AN' BEDDER OPTIONS

PART NO.	DESCRIPTION	WT.	PRICE
FTB4-RTH	Next GEN heavy duty trail hitch (comes with CAT 3 perfect hitch)		2,365.00
FTB4-SCR-30	Scrapers for 30' unit equipped with steel rings (call for other sizes)		1,045.00
HKFTB4-TH	Hose kit for Heavy Duty Rear Trail Hitch hydraulic circuit (1 pair)		575.00
Specify on order	Optional double lip clevis for rear hitch		255.00

ORDERS@TGSCHMEISER.COM

LEVELER PRICE LIST

DRAG SCRAPER & SPEED LEVELER



SDSM-10 shown w/ optional side blades

DRAG SCRAPER

Assembly charge - N/A

MODEL NO.	SIZE	HP RANGE	CAPACITY	Weight	PRICE
SDS08	8 ft.	65-85	2 Cubic Yards	1,580	\$ 9,475.00
SDSM08 (Medium)	8 ft.	65-85	2 Cubic Yards	1,300	8,365.00
SDS10	10 ft.	75-100	2.5 Cubic Yards	1,690	9,780.00
SDSM10 (Medium)	10 ft.	75-100	2.5 Cubic Yards	1,400	8,600.00
SDS12	12 ft.	90-110	3 Cubic Yard	1,860	10,755.00
SDSM12 (Medium)	12 ft.	90-110	3 Cubic Yard	1,560	9,460.00
SDS14	14 ft.	100-130	3.5 Cubic Yards	2,000	11,245.00
SDSM14 (Medium)	14 ft.	100-130	3.5 Cubic Yards	1,680	9,905.00

Standard Accessories: Lead hoses, transport safety chain, replaceable long-life UHMW wheel axle bushings, reversible/replaceable wheel axle spindles. Jack Stand. SDS units are 3 pt. Cat II / Cat II Quick Hitch compatible.

Light kit included on all units

OPTIONS

PART NO.	DESCRIPTION	PRICE
Call Factory	Hydraulic Tilt-Leg Option	1,415.00
Call Factory	Turnbuckle Tilt-Leg Option	615.00
SLP-BKS	Replaceable / Reversible Side Blades (Pair with fasteners)	300.00
SDS-GPS	GPS & Laser Stand	290.00
GMB-HITCHVBK	Perfect Hitch V-Block Kit, Cat 2-3	85.00

SPEED LEVELER

Assembly charge - N/A

MODEL NO.	SIZE	PRICE
SSL10	10 ft.	\$5,960.00



10 ft. wide main unit with turnbuckle adjustable gauge wheels, replaceable spindles, center buster and standard V-blade replacement blades (10 ft. rears). 14 ft. drag pipe for a smooth finish. Quick & easy post harvest clean up

ORDERS@TGSCHEMEISER.COM

LEVELER PRICE LIST

V-BLADE LEVELER™



VBL model
w/ rear smoothing plate



VBL-R model
w/ 8" rear roller

V-BLADE LEVELER

Assembly charge - n/c - fully assembled

***** VBL model *****

***** VBL-R roller model *****

SIZE	APPROX. HP	MODEL	WT.	PRICE	MODEL	WT.	PRICE
8 ft	40 - 55	VBL-08	1,765 lbs.	\$ 7,090.00	VBL-08R	1795 lbs.	\$ 7,245.00
9	45 - 60	VBL-09	1,882	7,275.00	VBL-09R	1,910	7,455.00
10	50 - 65	VBL-10	1,992	7,455.00	VBL-10R	2,018	7,690.00
11	55 - 70	VBL-11	2,101	7,765.00	VBL-11R	2,124	7,960.00
12	60 - 75	VBL-12	2,187	8,015.00	VBL-12R	2,209	8,185.00
13	65 - 80	VBL-13	2,322	8,250.00	VBL-13R	2,343	8,445.00
14	75 - 90	VBL-14	2,430	8,575.00	VBL-14R	2,450	8,710.00
15	75 - 95	VBL-15	2,562	8,840.00	VBL-15R	2,580	8,920.00
16	80 - 100	VBL-16	2,650	9,235.00	VBL-16R	2,667	9,435.00
17	85 - 105	VBL-17	2,798	9,590.00	VBL-17R	2,813	9,715.00
18	90 - 110	VBL-18	2,926	10,040.00	VBL-18R	2,939	10,125.00

Light kit included on units 12' and up

V-BLADE OPTIONS

PART NO.	DESCRIPTION	WT.	PRICE
3VB-D	Berm Scraper Assembly (pair)	65 lbs.	\$ 1,155.00
3VB-DR	Berm Scraper Assembly-Roller Model (pair)	65	1,320.00
3VB-L	Overflow Shield Kit	27	345.00
3VB-F	Shipping Stands for Vertical Shipping (can be returned for credit)		85.00

Visit our website @ www.tgschmeiser.com

LEVELER PRICE LIST

BANTAM LEVELER™



BANTAM LEVELER

Assembly charge - \$ 275 net - ready to tow

MODEL #	SIZE (width x length)	APPROX. HP	DRY WT.	WT. W/ FLUID	PRICE
BOL 080	8 x 18 Complete	40 - 50	2,414 lbs.	3,414 lbs.	\$ 15,350.00
BOL 090	9 x 18 Complete	45 - 55	2,523	3,648	15,590.00
BOL 100	10 x 18 Complete	50 - 60	2,632	3,882	15,870.00
BOL 110	11 x 18 Complete	55 - 65	2,741	4,116	16,180.00
BOL 120	12 x 18 Complete	60 - 70	2,850	4,350	16,625.00
BOL 130	13 x 18 Complete	65 - 75	2,959	4,584	17,070.00
BOL 140	14 x 18 Complete	70 - 80	3,068	4,818	17,375.00
BOL 150	15 x 18 Complete	75 - 85	3,177	5,052	17,810.00
BOL 160	16 x 18 Complete	80 - 95	3,286	5,286	18,605.00
BOL 170	17 x 18 Complete	85 - 100	3,795	5,920	18,855.00
BOL 180	18 x 18 Complete	90 - 105	3,904	6,154	19,300.00

All units include: jack stand, adjustable off-set hitch, mud scraper, heavy duty bucket cranks, 1-11/16" bearings.
 (2) 7.60 x 15 8 ply tires, (2) wheels, 4 x 16 cyl., wheel axle, all hoses and transport lockout.

Light kit included on all units

1 800 288-8128 Order Desk

LEVELER PRICE LIST
MODEL 77 ORCHARD LEVELER™



MODEL 77 ORCHARD LEVELER

Assembly charge - \$ 450 net - ready to tow

Shipping Stack (fits in 16' of deck space) - \$495

MODEL NO.	WIDTH	TILL AN' PAK		APPROX.	TURNING	WT.	PRICE	DOUBLE
		TUBE	RING SIZE	H.P.	RADIUS			FLAT ROLLER
LL-77-10 x 20	10 ft.	10	12/16	55 - 65	16 ft.	5,240 lbs	\$ 28,535.00	\$ 28,265.00
LL-77-10 x 20	10 ft.	12	14/20	55 - 65	16 ft.	6,050	30,860.00	
LL-77-11 x 20	11 ft.	10	12/16	60 - 70	17 ft.	5,520	29,215.00	28,680.00
LL-77-11 x 20	11 ft.	12	14/20	60 - 70	17 ft.	6,411	31,780.00	
LL-77-12 x 20	12 ft.	10	12/16	65 - 75	18 ft.	5,800	29,835.00	30,130.00
LL-77-12 x 20	12 ft.	12	14/20	65 - 75	18 ft.	6,772	32,875.00	
LL-77-14 x 20	14 ft.	10	12/16	75 - 90	20 ft.	6,320	31,255.00	32,240.00
LL-77-14 x 20	14 ft.	12	14/20	75 - 90	20 ft.	7,454	35,280.00	
LL-77-15 x 20	15 ft.	10	12/16	85 - 100	22 ft.	6,800	32,425.00	33,395.00
LL-77-15 x 20	15 ft.	12	14/20	85 - 100	22 ft.	8,100	36,515.00	

Includes hydraulic cylinders, 15" wheels, lead hoses, connecting hoses, (4) 7.60 x 15 tires, & tongue jack.
 Rear roller mud scrapers are now standard.

Light kit included on all units

ORDERS@TGSCHMEISER.COM

LEVELER PRICE LIST

VARITRAK™ AND SCHMEISER GRADER BLADE™

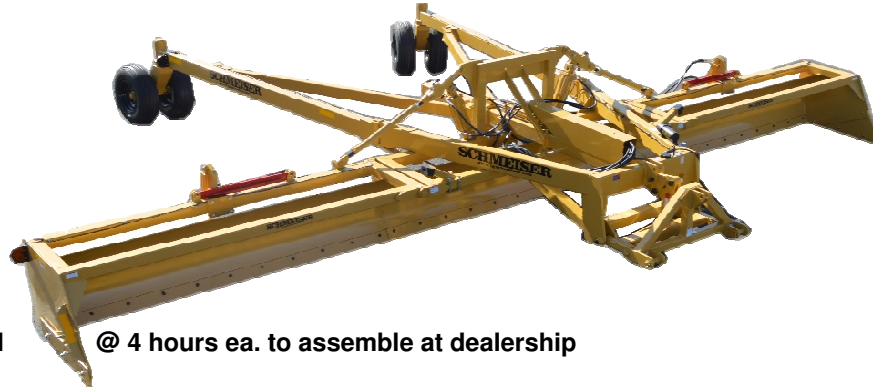

VARITRAK LEVELER

Ships with wings on. 2 personnel

@ 4 hours ea. to assemble at dealership

** Lead Hoses Included

MODEL NO.	BUCKET WIDTH	REAR WHEELS	RIGID - FOLDING	TRANSPORT WIDTH	PRICE
SVT - 16S	16 ft.	Steel (18" x 30")	RIGID	16' 6" x 24'	\$ 27,535.00
SVT - 16R	16 ft.	Dual Rubber	RIGID	16' 6" x 24'	26,510.00
SVT - 20S	20 ft.	Steel (18" x 30")	FOLDING	13' 6" x 24'	38,580.00
SVT - 20R	20 ft.	Dual Rubber	FOLDING	13' 6" x 24'	37,790.00
SVT - 24S	24 ft.	Steel (18" x 30")	FOLDING	13' 6" x 24'	39,945.00
SVT - 24R	24 ft.	Dual Rubber	FOLDING	13' 6" x 24'	38,730.00
SVT - 30R	30 ft.	Dual Rubber	FOLDING	15' 6" x 24'	45,840.00

- Includes self leveling compensation hitch, extra HD bushings in all high wear pivot points including hitch and rear stabilizer arms. Pivot assembly on rear wheels are comprised of 3" shaft, thrust brgs, and bushings.
- Folding models include (2) 4" x 12" wing cylinders, (1) 3" x 36" rear frame cylinder and connecting hoses.

VARITRAK OPTIONS

MODEL NO.	DESCRIPTION	PRICE
SVT-LHU	Laser Hitch Upgrade	\$ 1,105.00
SVT-L-16	S-Tine Option for 16 ft. Units	5,575.00
SVT-L-20	S-Tine Option for 20 ft. Units	7,540.00
SVT-L-24	S-Tine Option for 24 ft. Units	7,950.00
SVT-L-30	S-Tine Option for 30 ft. Units	8,645.00

Note: Laser hitch upgrade includes (1) 4" x 12" cylinder, cylinder anchor mount, and laser receiver mounting stand (laser not included).

Light kit included on all units



GRADER BLADE

Assembly charge - n/c

**Transport width - 7'-6"

MODEL NO.	BUCKET WIDTH	WEIGHT	TRANSPORT WIDTH	PRICE
SGB-20	20 ft.	3,300 lbs.	8' 0"	\$ 28,065.00
SGB-30	30 ft.	4,200	8' 0"	33,905.00
SGB-40	40 ft.	4,900	8' 0"	35,345.00

- Hydraulic depth control standard on all units - Lead hoses & rear transport lights included
- Includes (4) 205-75-D15 transport tires and wheels and (4) 205-75-D15 reversible gauge wheels.

Light kit included on all units

1 800 288-8128 Order Desk

LEVELER PRICE LIST

TRI-PLANE LAND LEVELER



TRI-PLANE LEVELER

Assembly charge - \$ 525 net - ready to tow

Partial assembly - \$ 275 net (11' 5" transport width partially assembled)

Est. 10-12 hrs @ dealership to complete assembly

MODEL NO.	WIDTH x LENGTH	FRONT WHEELS	APPROX H.P.	WEIGHT	PRICE
SLP 12DS30	12 ft. x 30 ft.	Dual Steel	115 - 140	7,040 lbs.	\$ 45,595.00
SLP 12QR30	12 ft. x 30 ft.	Quad Rubber	115 - 140	6,640	45,140.00
SLP 14DS30	14 ft. x 30 ft.	Dual Steel	130 - 155	7,190	46,180.00
SLP 14QR30	14 ft. X 30 ft.	Quad Rubber	130 - 155	6,790	45,735.00
SLP 14DS	14 ft. x 40 ft.	Dual Steel	130 - 155	7,490	47,265.00
SLP 14QR	14 ft. x 40 ft.	Quad Rubber	130 - 155	7,090	46,795.00
SLP 16DS30	16 ft. x 30 ft.	Dual Steel	150 - 175	7,330	47,095.00
SLP 16QR30	16 ft. x 30 ft.	Quad Rubber	150 - 175	6,930	46,650.00
SLP 16DS	16 ft. x 40 ft.	Dual Steel	150 - 175	7,630	48,005.00
SLP 16QR	16 ft. x 40 ft.	Quad Rubber	150 - 175	7,230	47,565.00
SLP 18DS30	18 ft. x 30 ft.	Dual Steel	170 - 190	7,430	47,565.00
SLP 18QR30	18 ft. x 30 ft.	Quad Rubber	170 - 190	7,030	47,180.00
SLP 18DS	18 ft. x 40 ft.	Dual Steel	170 - 190	7,730	48,655.00
SLP 18QR	18 ft. x 40 ft.	Quad Rubber	170 - 190	7,330	48,370.00

- Includes hydraulic transport assembly (with two 12.5 x 16 tires and two 3-1/2 x 8" welded cylinders).
- Lead hoses included.
- Dual steel units include (4) 30" dia. X 18" wide steel wheels with 1-11/16 flange bearings.
- 1/2 x 6 Blade standard
- Quad rubber tire units include (4) 9.5L x 15 rib implement tires on front end of machine in lieu of 2 steel wheels

LAND LEVELER OPTIONS

MODEL NO.	DESCRIPTION	WEIGHT	PRICE
SLPA10HBO	Hydraulic Bucket Option - Lead hoses included	220 lbs.	\$ 2,045.00
SLP-SHIPBAR	Bar to ship unit partially assembled (can be returned for credit)		300.00

Light kit included on all units

Visit our website @ www.tgshmeiser.com

LEVELER PRICE LIST

FOLDING TRI-PLANE LAND LEVELER



SLP24DSF in transport mode



SLP24DSF model in field mode

FOLDING TRI-PLANE LEVELER

Assembly Included

MODEL NO.	WIDTH x LENGTH	FRONT WHEELS	APPROX H.P.	WEIGHT	PRICE
SLP 18DSF	18 ft. x 40 ft.	Dual Steel	180-225	9,140 lbs.	\$ 60,690.00
SLP 20DSF	20 ft. x 40 ft.	Dual Steel	200-260	9,250	61,340.00
SLP 20QRF	20 ft. x 40 ft.	Quad Rubber	200-260	8,850	60,715.00
SLP 22DSF	22 ft. x 40 ft.	Dual Steel	220-280	9,360	61,960.00
SLP 22QRF	22 ft. x 40 ft.	Quad Rubber	220-280	8,960	61,365.00
SLP 24DSF	24 ft. x 40 ft.	Dual Steel	240-300	9,470	62,760.00
SLP 24QRF	24 ft. x 40 ft.	Quad Rubber	240-300	9,070	62,145.00

- Folded Transport width is 11'0" (Manual Fold Only)
- Includes hydraulic transport assembly (with two 12.5 x 16 tires and two 3-1/2 x 8" welded cylinders).
- Lead hoses included.
- Dual steel units include (4) 30" dia. X 18" wide steel wheels with 1-11/16 flange bearings.
- 1/2 x 6 Blade standard
- Quad rubber tire units include (4) 9.5L x 15 rib implement tires on front end of machine in lieu of 2 steel wheels

1 800 288-8128 Order Desk

LEVELER PRICE LIST

PRECISION FINISHING SCRAPER



PRECISION FINISHING SCRAPER

PFS 24 w/ End Tow Option Shown

MODEL NO.	WIDTH x LENGTH	APPROX H.P.	CU/YD	WEIGHT	PRICE
PFS 12	12 ft. x 22 ft.	145-200	8.6	6,800 lbs.	\$ 35,925.00
PFS 14	14 ft. x 22 ft.	170-230	9.5	7,000	37,240.00
PFS 16	16 ft. x 22 ft.	190-265	10.9	7,200	38,975.00
PFS 18	18 ft. x 22 ft.	215-300	12.2	7,400	41,755.00
PFS 20	20 ft. x 22 ft.	240-330	13.6	8,500	45,170.00
PFS 22	22 ft. x 22 ft.	265-365	15	8,720	47,890.00
PFS 24	24 ft. x 22 ft.	300-400	16.3	8,980	51,075.00

- 12, 14, and 16 ft. units include (4) 31x13.5 Tires, Lead Hoses & Tips - Laser Tower not included
 - 18 ft., 20 ft., 22 ft., and 24 ft. units include (4) 16.5x16 Tires, Lead Hoses & Tips

PRECISION FINISHING SCRAPER OPTIONS

MODEL NO.	DESCRIPTION	WEIGHT	PRICE
PFS-LTO	Laser Tower - each	144 lbs.	\$ 1,240.00
PFS-TO*	End Tow Transport ~ Available on 20', 22' & 24' units	1600	11,335.00
PFS-RWO	Rear Wheel Option	-	6,510.00
PFS-GPS	GPS Stand - each	24	230.00
PFS-SWH	Swivel Hitch	67	1,330.00
PFS-HKJF	Hydraulic Hose Kit - For End Tow Models	-	435.00
PFS-HKJR	Hydraulic Hose Kit - Rigid units	-	405.00

* End Tow transport width 12'7"

If ordering (1) Laser Tower or GPS Stand, you do **NOT** need to add a hose kit. Only add a hose kit if ordering (2) GPS Stands or (2) Laser towers. (1) Hose kit is included in the base model number

Visit our website @ www.tgschmeiser.com

RIPPER PRICE LIST

FINISHING RIPPER CHISEL



3 Bar model
(shown w/ gauge wheels)

2 BAR FINISHING CHISEL Assembled - n/c

MODEL NO.	Width	# of Shanks	Spacing	Description	Approx. Wt.	PRICE
SFC-213	13 ft.	13	12"	1-1/4" x 30" shank w/ alfalfa spike	3,000 lbs.	\$ 15,290.00
SFC-215	15 ft.	15	12"	1-1/4" x 30" shank w/ alfalfa spike	3,300	16,720.00
SFC-217	17 ft.	17	12"	1-1/4" x 30" shank w/ alfalfa spike	3,600	18,140.00
SFC-219	19 ft.	19	12"	1-1/4" x 30" shank w/ alfalfa spike	3,900	18,810.00
SFC-221	21 ft.	21	12"	1-1/4" x 30" shank w/ alfalfa spike	4,200	21,090.00
SFC-223	23 ft.	23	12"	1-1/4" x 30" shank w/ alfalfa spike	4,500	22,335.00
SFC-225	25 ft.	25	12"	1-1/4" x 30" shank w/ alfalfa spike	4,800	23,690.00

Complete with Cat III & IV 3pt. Hitch. Gauge wheels are available, see options section below.

3 BAR FINISHING CHISEL Assembled - n/c minimal assembly required

MODEL NO.	Width	# of Shanks	Spacing	Description	Approx. Wt.	PRICE
SFC-313	13 ft.	13	12"	1-1/4" x 30" shank w/ alfalfa spike	3,200 lbs.	\$ 16,865.00
SFC-315	15 ft.	15	12"	1-1/4" x 30" shank w/ alfalfa spike	3,600	18,295.00
SFC-317	17 ft.	17	12"	1-1/4" x 30" shank w/ alfalfa spike	4,300	19,870.00
SFC-319	19 ft.	19	12"	1-1/4" x 30" shank w/ alfalfa spike	4,600	21,175.00
SFC-321	21 ft.	21	12"	1-1/4" x 30" shank w/ alfalfa spike	4,900	23,030.00
SFC-323	23 ft.	23	12"	1-1/4" x 30" shank w/ alfalfa spike	5,250	23,945.00
SFC-325	25 ft.	25	12"	1-1/4" x 30" shank w/ alfalfa spike	5,600	25,910.00

Complete with Cat III & IV 3pt. Hitch. Gauge wheels are available, see options section below.

OPTIONS

PART NO.	DESCRIPTION	PRICE
SFC-GWS	Standard Duty Gauge Wheels with (2) 9.5 x 15" Rib Imp Tires	\$ 3,360.00
SFC-GWHD	Heavy Duty Gauge Wheels with (2) 12.5 x 16" Rib Imp Tires	4,150.00
SFC-D	Heavy Duty Gauge Wheel Cranks - Upgrade (Flat acme thread - EZ adjust)	480.00
SFC-GWDS	Heavy Duty Gauge Wheels with Dual Steel Wheels (4 wheels total)	5,585.00
SFC-RH3B	Rear Trail Hitch (for 3-bar models)	555.00
SFC-RH2B	Rear Trail Hitch (for 2 bar models)	480.00

RIPPER PRICE LIST

S-SERIES



S-SERIES - 3 POINT

Assembled - n/c

MODEL NO.	# of Shanks	Spacing	Shank Size		Weight	PRICE
S53430	5	30"	1-1/4" x 34"	S-Series - "L" Shank design	5,145 lbs.	\$ 25,505.00
S73420	7	20"	1-1/4" x 34"	S-Series - "L" Shank design	5,905	27,605.00
S73422	7	22"	1-1/4" x 34"	S-Series - "L" Shank design	5,984	27,640.00
S73424	7	24"	1-1/4" x 34"	S-Series - "L" Shank design	6,100	28,055.00
S73430	7	30"	1-1/4" x 34"	S-Series - "L" Shank design	6,512	28,815.00
S53630	5	30"	1-1/2" x 36"	S-Series - "L" Shank design	6,124	28,900.00
S73620	7	20"	1-1/2" x 36"	S-Series - "L" Shank design	6,908	31,750.00
S73622	7	22"	1-1/2" x 36"	S-Series - "L" Shank design	7,054	32,045.00
S73624	7	24"	1-1/2" x 36"	S-Series - "L" Shank design	7,255	32,330.00
S73630	7	30"	1-1/2" x 36"	S-Series - "L" Shank design	7,788	33,685.00

Complete with Cat III & IV 3pt. hitch, dual gauge wheels w/ (4) 7" x 30" steel wheels, chrome points and replaceable shins.

Crumbler attachment available. See page #26 for Crumbler prices. **Wear guards now included on all units. Cat III and CAT IV Narrow QH

Light kit included on all units

RIPPER OPTIONS

PART NO.	DESCRIPTION		PRICE
EP	Extra Pockets - per pocket	80	340.00
RH	Rear Hitch for S-Series and P-Series	100	540.00
*P	36" Parabolic Shank Option (in lieu of "L" Shank design) per shank	-	n/c
S*38**P	38" Parabolic Shank Upgrade (each shank) From 36" shank	20	140.00
S*42**P	42" Parabolic Shank Upgrade (each shank)	60	270.00

Note: Approximately 35 to 60 H.P. required per "L" shank. Results may vary depending on ground conditions.

Note: See page #25 for Crumbler attachments

ORDERS@TGSCHMEISER.COM

RIPPER PRICE LIST

C-SERIES RIPPER



C-SERIES - 3 POINT

Assembled - n/c minimal assembly required

MODEL NO.	Shanks	Spacing	Shank Size		Weight	PRICE
C53624	5	24"	1-1/2" x 36"	C-Series - "L" Shank design	4,600 lbs.	\$ 19,195.00
C53630	5	30"	1-1/2" x 36"	C-Series - "L" Shank design	4,867	19,735.00
C73620	7	20"	1-1/2" x 36"	C-Series - "L" Shank design	5,798	23,255.00
C73622	7	22"	1-1/2" x 36"	C-Series - "L" Shank design	5,972	23,560.00
C73624	7	24"	1-1/2" x 36"	C-Series - "L" Shank design	6,076	23,700.00
C73630	7	30"	1-1/2" x 36"	C-Series - "L" Shank design	6,585	24,620.00

Complete with Cat. III & IV hitch, 3" x 12" Chrome points and replaceable shins. Gauge wheels not available on this unit.
 Designed for use with Down Pressure Roller. See page #27 for options and DPR prices.**Wear guards now included

Light kit included on all units

RIPPER OPTIONS

PART NO.	DESCRIPTION	Weight	PRICE
EP	Extra Pockets - per pocket	80	340.00
*P	36" Parabolic Shank Option (in lieu of "L" Shank design) per shank	-	n/c
C*38**P	38" Parabolic Shank Upgrade (each shank)	20	140.00

Note: Approximately 35 to 60 H.P. required per "L" shank. Results may vary depending on ground conditions.

See page #26 for Down Pressure Roller attachments

1 800 288-8128 Order Desk

RIPPER PRICE LIST

P-SERIES RIPPER



Shown w/ CWD counterweight

P-SERIES - PULL TYPE

Assembled - n/c some additional assembly required

MODEL NO.	# of Shanks	Spacing	Shank Size		WEIGHT	PRICE
P53630	5	30"	1-1/2" x 36"	P-Series	9,218 lbs.	\$ 49,335.00
P53630D	5	30"	1-1/2" x 36"	P-Series - Detachable	9,432	49,610.00
P73622	7	22"	1-1/2" x 36"	P-Series	9,218	52,815.00
P73622D	7	22"	1-1/2" x 36"	P-Series - Detachable	9,406	53,405.00
P73624	7	24"	1-1/2" x 36"	P-Series	9,218	53,115.00
P73624D	7	24"	1-1/2" x 36"	P-Series - Detachable	9,396	53,690.00
P73630D	7	30"	1-1/2" x 36"	P-Series - Detachable	9,500	54,430.00

Complete with geared flow divider, auto rephase gauge wheels, single point depth control gauging, & chrome points and shins.
Lead hoses included. Available with Down Pressure Roller or Crumbler. Be sure to order appropriate counterweight.

*** 9 & 11 Shank units available - Call Factory for pricing & details ***

RIPPER OPTIONS

PART NO.	DESCRIPTION		PRICE
EP	Extra Pockets - per pocket	80	340.00
RH	Rear Hitch for S-Series and P-Series	100	540.00
*P	36" Parabolic Shank Option (in lieu of "L" Shank design) per shank	-	n/c
P*38**P	38" Parabolic Shank Upgrade (each shank)	20	140.00
CWD	Counterweight for Pull-Type Ripper with Down Pressure Roller	1800	4,180.00
CWC	Counterweight for Pull-Type Ripper with Crumbler Roller	900	2,090.00

Note: Approximately 35 to 60 H.P. required per "L" shank. Results may vary depending on ground conditions.

See pages 25 & 26 for Crumbler and DPR attachments

RIPPER PRICE LIST

CRUMBLER



CRUMBLER - SPIRAL PADDLE

Assembled - n/c

Assembled to Ripper - \$50 net

MODEL NO.	WIDTH	# of Paddles	Rear Bar (height x width)	WEIGHT	PRICE
CS5-144	12 ft.	5	7" x 7" or 7" x 5"	2467 lbs.	\$ 12,020.00
CS5-156	13 ft.	5	7" x 7" or 7" x 5"	2540	12,160.00
CS5-168	14 ft.	5	7" x 7" or 7" x 5"	2613	12,410.00
CS5-180	15 ft.	5	7" x 7" or 7" x 5"	2748	12,870.00
CS5-192	16 ft.	5	7" x 7" or 7" x 5"	2951	13,415.00
CS5-204	17 ft.	5	7" x 7" or 7" x 5"	3123	13,970.00

For use on S-Series and P-Series Rippers. P-Series Rippers must use counterweight option #CWC.



CRUMBLER - STRAIGHT PADDLE

Assembled - n/c

Assembled to Ripper - \$50 net

MODEL NO.	WIDTH	# of Paddles	Rear Bar (height x width)	WEIGHT	PRICE
CS7-144	12 ft.	7	7" x 7" or 7" x 5"	2466 lbs.	\$ 9,455.00
CS7-156	13 ft.	7	7" x 7" or 7" x 5"	2539	9,900.00
CS7-168	14 ft.	7	7" x 7" or 7" x 5"	2612	10,215.00
CS7-180	15 ft.	7	7" x 7" or 7" x 5"	2755	10,670.00
CS7-192	16 ft.	7	7" x 7" or 7" x 5"	2965	11,130.00
CS7-204	17 ft.	7	7" x 7" or 7" x 5"	3181	11,575.00

For use on S-Series and P-Series Rippers. P-Series Rippers must use counterweight option #CWC.

See Page #24 & 26 for Ripper Prices

RIPPER PRICE LIST
DOWN PRESSURE ROLLER



DOWN PRESSURE ROLLER

Assembled - n/c

Assembled to Ripper - \$50 net

MODEL NO.	Width	Rear Bar (height x width)	Weight	PRICE
DPR-108	9 ft.	7" x 7"	4,381 lbs.	\$ 24,735.00
DPR-120	10 ft.	7" x 7"	4,648	25,450.00
DPR-144	12 ft.	7" x 7"	4,915	26,725.00
DPR-156	13 ft.	7" x 7"	5,242	28,010.00
DPR-168	14 ft.	7" x 7"	5,513	29,430.00
DPR-180	15 ft.	7" x 7"	5,783	30,855.00
DPR-192	16 ft.	7" x 7"	5,783	32,265.00
DPR-204	17 ft.	7" x 7"	6,234	34,105.00
CWD	Counterweight for Pull-Type Ripper with Down Pressure Roller			4,180.00
For use on C-Series and P-Series Rippers only. P-Series Rippers must use counterweight option #CWD.				

See Page #23 & 24 for Ripper Prices

Visit our website @ www.tgschmeiser.com

RIPPER PRICE LIST

V-SERIES RIPPER

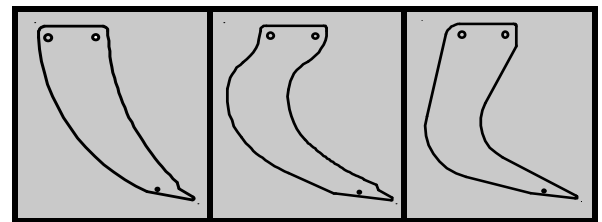

Standard

Parabolic

"L" Shank

V-Series Ripper - Vineyard Model

Assembled - n/c

MODEL NO.	# of Shanks	Spacing	Shank Size		WEIGHT	PRICE	
VR327S	3	30"	1-1/4" x 27"	V-Series - Standard Shank	1,050 lbs.	\$ 6,025.00	
VR327P	3	30"	1-1/4" x 27"	V-Series - Parabolic Shank	1,075	6,025.00	
VR327L	3	30"	1-1/4" x 27"	V-Series - "L" Shank design	1,104	6,025.00	
VR331S	3	30"	1-1/4" x 31"	V-Series - Standard Shank	1,102	6,390.00	
VR331P	3	30"	1-1/4" x 31"	V-Series - Parabolic Shank	1,127	6,390.00	
VR331L	3	30"	1-1/4" x 31"	V-Series - "L" Shank design	1,154	6,390.00	
VR334S	3	30"	1-1/4" x 34"	V-Series - Standard Shank	1,150	7,030.00	
VR334P	3	30"	1-1/4" x 34"	V-Series - Parabolic Shank	1,175	7,030.00	
VR334L	3	30"	1-1/4" x 34"	V-Series - "L" Shank design	1,202	7,030.00	
VSR-00A100	Rear Trail Hitch - Factory Install Only						550.00

Category II or Cat II quick hitch. 6 x 6 main frame construction. 2-1/4" x 7-1/2" Chrome shin guard & point standard.

Overall Frame width: 64-3/4"

Note: Approximately 25 to 35 H.P. required per shank. Results may vary depending on ground conditions.

Caution: Tractors with smaller tires may have ground clearance issues with 34" shanks.

RIPPER PRICE LIST

MID ROW RIPPER



DPR024 Rear Roller

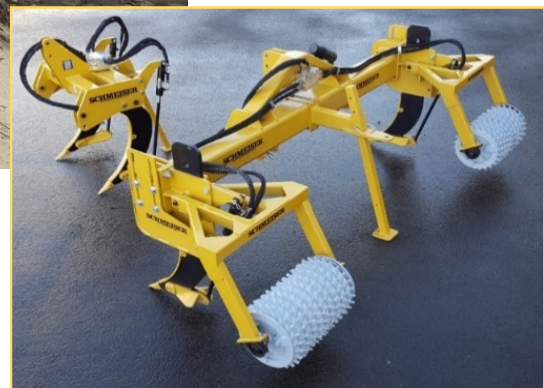

HD & MINI SERIES

Assembled - n/c minimal assembly required

MODEL NO.	Shanks	Adj. Shank Depth	Width	Shank Spacing	Weight	PRICE
ASW32036	2	24"	3', Mini	33-3/4"	690 lbs.	\$ 11,700.00
ASW32048	2	24"	4', Mini	44-3/4"	730 lbs.	11,905.00
ASW32060	2	24"	5', Mini	55-3/4"	775 lbs.	12,105.00
ASW52060	2	24", 28", & 32"	5', HD	4'-6"	1265 lbs.	13,280.00
ASW52072	2	24", 28", & 32"	6', HD Adjustable	4'-6" to 5'-4"	1300 lbs.	13,560.00
ASW52084	2	24", 28", & 32"	7', HD Adjustable	4'-6" to 6'-4"	1350 lbs.	13,700.00
ASW52096	2	24", 28", & 32"	8', HD Adjustable	4'-6" to 7'-4"	1400 lbs.	13,850.00
ASW52120	2	24", 28", & 32"	10', HD Adjustable	4'-6" to 9'-4"	1500 lbs.	14,140.00
ASW52132	2	24", 28", & 32"	11', HD Adjustable	5'-6" to 10'-4"	1590 lbs.	14,435.00
ASW52144	2	24", 28", & 32"	12', HD Adjustable	5'-6" to 11'-4"	1640 lbs.	14,550.00

OPTIONS

PART NO.	DESCRIPTION	Weight	PRICE
TP02101216D-RR	2 Ft. Till an' Pak Pup - For HD Ripper only 10" tube, 12/16 ring (each)	450	2,350.00
TP02101216D-6RR	2 Ft. 6" Till an' Pak Pup - For HD Ripper only 10" tube, 12/16 ring (each)	515	2,480.00
TP02121420D-RR	2 Ft. Till an' Pak Pup - For HD Ripper only 12" tube, 14/20 ring (each)	615	2,775.00
TP02121420D-6RR	2 Ft. 6" Till an' Pak Pup - For HD Ripper only 12" tube, 14/20 ring (each)	725	3,000.00
DPR024	2 Ft. Down Pressure Roller - 12/20 Steel Star Ring w/ Mud Scrapers (ea)	435	2,935.00
DPR030	2 Ft. 6" Down Pressure Roller - 12/20 Steel Star Ring w/ Mud Scrapers (ea)	535	3,415.00
SWKS-0050	Dirt Crowdors for HD MRR		1,785.00
*SWKS-0060	Hydraulic Oil Cooling System (Heat exchanger, hoses, fittings, brackets)		860.00
SWKS-0048K	18" Extension Kit for HD MRR - Includes extensions and fasteners		930.00

HD Rippers will come standard with adjustable depth gauging when ordered with Till an' Pak Pups

*Some tractors are equipped with smaller hydraulic reservoir systems and may need additional cooling.

Note: Approximately 35 to 55 H.P. required per shank. Results may vary depending on ground conditions.

Note: For Till an' Pak rollers for Mini Mid Row Ripper - use standard Till an' Pak pricing on Page #4 of Price List.

3-POINT CULTI-PLOW PRICE LIST

2 BAR & 3 BAR MODELS

2 BAR - VINEYARD MODEL

Assembly charge - n/c



MODEL NO.	DESCRIPTION		WT.	PRICE
4CP-1	4 Ft. Culti-Plow (single 1" x 2" shank)	5 shanks	413 lbs	\$ 3,220.00
5CP-1	5 Ft. Culti-Plow (single 1" x 2" shank)	5 shanks	438	3,280.00
6CP-1	6 Ft. Culti-Plow (single 1" x 2" shank)	5 shanks	463	3,350.00
7CP-1	7 Ft. Culti-Plow (single 1" x 2" shank)	7 shanks	520	3,915.00
8CP-1	8 Ft. Culti-Plow (single 1" x 2" shank)	7 shanks	545	4,025.00
4CP-3	4 Ft. Culti-Plow (double shank combo 3/4" x 2" & 1" x 2")	5 shank sets	508	3,570.00
5CP-3	5 Ft. Culti-Plow (double shank combo 3/4" x 2" & 1" x 2")	5 shank sets	533	3,655.00
6CP-3	6 Ft. Culti-Plow (double shank combo 3/4" x 2" & 1" x 2")	5 shank sets	558	3,750.00
7CP-3	7 Ft. Culti-Plow (double shank combo 3/4" x 2" & 1" x 2")	7 shank sets	647	4,555.00
8CP-3	8 Ft. Culti-Plow (double shank combo 3/4" x 2" & 1" x 2")	7 shank sets	672	4,615.00

Unit equipped with 3/4" x 2" x 16" reversible chisel points - Safety stand is standard

2 BAR OPTIONS

PART NO.	DESCRIPTION		WT.	PRICE
CP-1 EX	1 Ft. Extensions (single 1" x 2" shank)	(1 pair)	178 lbs.	\$ 880.00
CP-3 EX	1 Ft. Extensions (double shank combo 3/4" x 2" & 1" x 2")	(1 pair)	216	1,105.00
CP-THTP	Rear Trail Hitch - to pull Till an' Pak behind Culti-Plow		35	270.00
3CP-RH	Rear Trail Hitch - Heavy Duty		65	425.00

3 BAR MODEL - HEAVY DUTY - Cat 2 & 3

Assembly charge - \$ 100 net - ready for field



MODEL NO.	DESCRIPTION	# OF SHANKS	WT.	PRICE
HCP310	10 Ft. Culti-Plow (Triple shank combo 3/4", 3/4" and 1" thick)	9 shank sets	1575 lbs.	\$ 10,965.00
HCP312	12 Ft. Culti-Plow (Triple shank combo 3/4", 3/4" and 1" thick)	11 shank sets	1811	12,180.00
HCP314	14 Ft. Culti-Plow (Triple shank combo 3/4", 3/4" and 1" thick)	13 shank sets	2047	13,380.00
HCP316	16 Ft. Culti-Plow (Triple shank combo 3/4", 3/4" and 1" thick)	15 shank sets	2283	14,750.00
HCP318	18 Ft. Culti-Plow (Triple shank combo 3/4", 3/4" and 1" thick)	17 shank sets	2519	16,320.00
HCP320	20 Ft. Culti-Plow (Triple shank combo 3/4", 3/4" and 1" thick)	19 shank sets	2755	17,600.00

All units are complete with 3 bars (4 x 4 x .375wall tubing), Cat.II, III, quick hitch II, III, IIIN.
Gauge wheels are optional.

Light kit included on all 3 Bar units

3 BAR OPTIONS

MODEL NO.	DESCRIPTION		WT.	PRICE
HCPGW	Gauge Wheels - includes (2) 9.50 x 15 tires (1 pair)		375 lbs.	\$ 2,585.00
HCPRH	Rear Trail Hitch		125	485.00

Note: Approximately 12 to 16 hp per shank assembly at 15" deep. Results may vary depending on ground conditions.

Visit our website @ www.tgschmeiser.com

ORCHARD DISC PRICE LIST

TANDEM DISC - HEAVY



DTH MODEL

MODEL NO.	# of Blades	Width	Blade Size	Spacing	Base Wt.	PRICE
DTH24-24NS	24	10'-0"	24" x 6mm	9"	4,900	\$ 26,045.00
DTH28-24	28	11'-0"	24" x 6mm	9"	5,171	26,855.00
DTH28-24NS	28	11'-0"	24" x 6mm	9"	5,135	26,895.00
DTH32-24	32	12'-6"	24" x 6mm	9"	5,418	27,760.00
DTH32-24NS	32	12'-6"	24" x 6mm	9"	5,376	27,790.00
DTH36-24	36	14'-0"	24" x 6mm	9"	6,001	30,590.00
DTH36-24NS	36	14'-0"	24" x 6mm	9"	5,954	30,635.00
DTH40-24	40	15'-6"	24" x 6mm	9"	6,239	31,335.00
DTH40-24NS	40	15'-6"	24" x 6mm	9"	6,187	31,375.00
DTH44-24	44	17'-0"	24" x 6mm	9"	6,486	32,235.00
DTH44-24NS	44	17'-0"	24" x 6mm	9"	6,745	32,265.00
DTH28-26	28	11'-0"	26" x 6mm	9"	5,348	\$ 27,610.00
DTH28-26NS	28	11'-0"	26" x 6mm	9"	5,297	27,680.00
DTH32-26	32	12'-6"	26" x 6mm	9"	5,619	28,490.00
DTH32-26NS	32	12'-6"	26" x 6mm	9"	5,561	28,585.00
DTH36-26	36	14'-0"	26" x 6mm	9"	6,228	31,485.00
DTH36-26NS	36	14'-0"	26" x 6mm	9"	6,162	31,560.00
DTH40-26	40	15'-6"	26" x 6mm	9"	6,491	32,225.00
DTH40-26NS	40	15'-6"	26" x 6mm	9"	6,418	32,310.00
DTH44-26	44	17'-0"	26" x 6mm	9"	6,763	33,280.00
DTH44-26NS	44	17'-0"	26" x 6mm	9"	6,682	33,350.00
HD 1-3/4" Gang Bolts, 1-3/4" Trunnion Bearings, ACME Thread Front Turnbuckle, Middle buster (Less Sweep), 9" blade spacing, Single point hydraulic depth control, Cat-3 Perfect Hitch, 12-28" Front Gang Adj., 10-26" Rear Gang Adj., Jack Stand, Lead hoses included. Transport Light Kit Standard						

OPTIONS - DTH ORCHARD DISC

PART NO.	DESCRIPTION	PRICE
DTS-24	Mud scraper blade set - 24 blade unit	1,855.00
DTS-28	Mud scraper blade set - 28 blade unit	2,250.00
DTS-32	Mud scraper blade set - 32 blade unit	2,505.00
DTS-36	Mud scraper blade set - 36 blade unit	2,975.00
DTS-40	Mud scraper blade set - 40 blade unit	3,265.00
DTS-44	Mud scraper blade set - 44 blade unit	3,480.00
SDO-T	REAR TRAIL HITCH	445.00
DRT-L012	DIRT DIVERTERS	485.00
GMB-HITCVBK	Perfect Hitch V-Block Kit Cat 2-3	85.00

1 800 288-8128 Order Desk

VINEYARD DISC PRICE LIST

3 POINT - TANDEM SUPER NARROW



TSN MODEL
Assembled - n/c

Shown w/ optional mounted Till an' Pak

MODEL NO.	# of Blades	Width of Cut	Frame Width	Blade Size	Blade Type	Base Wt.	PRICE
TSN8N	8	29" to 42"	45"	22" x 5mm	smooth / smooth	1,006 lbs.	\$ 7,925.00
TSN8N-NS	8	29" to 42"	45"	22" x 5mm	notched / smooth	1,002	7,980.00
TSN8N-NN	8	29" to 42"	45"	22" x 5mm	notched / notched	998	8,005.00
TSN8	8	29" to 53"	55"	22" x 5mm	smooth / smooth	1,026	8,140.00
TSN8-NS	8	29" to 53"	55"	22" x 5mm	notched / smooth	1,022	8,180.00
TSN8-NN	8	29" to 53"	55"	22" x 5mm	notched / notched	1,018	8,215.00
TSN10	10	46" to 66"	55"	22" x 5mm	smooth / smooth	1,181	8,940.00
TSN10-NS	10	46" to 66"	55"	22" x 5mm	notched / smooth	1,177	9,000.00
TSN10-NN	10	46" to 66"	55"	22" x 5mm	notched / notched	1,171	9,075.00
TSN12	12	46" to 66"	55"	22" x 5mm	smooth / smooth	1,336	9,895.00
TSN12-NS	12	46" to 66"	55"	22" x 5mm	notched / smooth	1,330	9,960.00
TSN12-NN	12	46" to 66"	55"	22" x 5mm	notched / notched	1,324	10,035.00

PART NO.	DESCRIPTION		
DBEOR225	Blade Extensions, rear outside w/ 22" x 5mm blade (pr.)		\$ 550.00
DBEOF225	Blade Extensions, front outside w/ 22" x 5mm blade (pr.)		550.00
DTS-8	Mud scraper blade set - 8 blade unit		255.00
DTS-10	Mud scraper blade set - 10 blade unit		645.00
DTS-12	Mud scraper blade set - 12 blade unit		1,005.00
DTS-SEK	Scraper arm & blade ass'y w/ scraper extension (one pair)		210.00
SDO-R	Rear Trail Hitch for 8 to 16 blade units		230.00
DRT-L012	Dirt Diverters (pair) for 8 blade and 10 blade models		485.00
DRT-L312	Dirt Diverters (pair) for 12 blade models		500.00
SDO-V	Dirt Diverter Extensions (pair)		165.00
DRT-M	Cane Deflectors (pair)		210.00

ORDERS@TGSCHMEISER.COM

VINEYARD DISC PRICE LIST

3PT. REVERSIBLE TANDEM - MEDIUM DUTY



Shown w/ dirt diverters, cane deflectors, and mud scrapers

RTM MODEL
 Assembly charge - n/c

MODEL NO.	# of Blades	Width of Cut	Frame Width	Blade Size	Blade (front/rear)	Base Wt.	PRICE
RTM12N	12	46" to 53"	48"	24" x 5mm	smooth / smooth	1,715 lbs.	\$ 10,925.00
RTM12N-NS	12	46" to 53"	48"	24" x 5mm	notched / smooth	1,709	10,990.00
RTM12N-NN	12	46" to 53"	48"	24" x 5mm	notched / notched	1,703	11,020.00
RTM12	12	53" to 66"	60"	24" x 5mm	smooth / smooth	1,754	11,070.00
RTM12-NS	12	53" to 66"	60"	24" x 5mm	notched / smooth	1,748	11,020.00
RTM12-NN	12	53" to 66"	60"	24" x 5mm	notched / notched	1,742	11,155.00
RTM14	14	63" to 84"	66"	24" x 5mm	smooth / smooth	1,895	11,975.00
RTM14-NS	14	63" to 84"	66"	24" x 5mm	notched / smooth	1,889	12,010.00
RTM14-NN	14	63" to 84"	66"	24" x 5mm	notched / notched	1,881	12,035.00
RTM16N	16	63" to 84"	66"	24" x 5mm	smooth / smooth	1,987	12,335.00
RTM16N-NS	16	63" to 84"	66"	24" x 5mm	notched / smooth	1,981	12,410.00
RTM16N-NN	16	63" to 84"	66"	24" x 5mm	notched / notched	1,971	12,455.00
RTM16W	16	63" to 101"	86"	24" x 5mm	smooth / smooth	2,063	12,555.00
RTM16W-NS	16	63" to 101"	86"	24" x 5mm	notched / smooth	2,055	12,590.00
RTM16W-NN	16	63" to 101"	86"	24" x 5mm	notched / notched	2,047	12,640.00
RTM18	18	81" to 119"	86"	24" x 5mm	smooth / smooth	2,215	13,065.00
RTM18-NS	18	81" to 119"	86"	24" x 5mm	notched / smooth	2,207	13,105.00
RTM18-NN	18	81" to 119"	86"	24" x 5mm	notched / notched	2,197	13,160.00

Reversible, 1-3/4" round axles, trunnion bearings w/ wear plates, 9" blade spacing,
 Cat I & II, Cat II quick hitch, middle buster, 0-30 degree gangs & tapered frame design.

OPTIONS - RTM 3PT. DISC.

PART NO.	DESCRIPTION		For Model #	PRICE
DBEOR245	Blade Extensions, rear outside w/ 24" x 5mm blade (pr.)		RTM	\$ 615.00
DBEOF245	Blade Extensions, front outside w/ 24" x 5mm blade (pr.)		RTM	615.00
DTS-12	Mud scraper blade set - 12 blade unit	TSN	RTM RTH	1,005.00
DTS-14	Mud scraper blade set - 14 blade unit		RTM RTH	1,115.00
DTS-16	Mud scraper blade set - 16 blade unit		RTM RTH	1,255.00
DTS-18	Mud scraper blade set - 18 blade unit		RTM RTH	1,435.00
DTS-SEK	Scraper arm & blade ass'y w/ scraper extension (one pair)	TSN	RTM RTH	210.00
SDO-R	Rear Trail Hitch for 12 to 16 blade units	TSN	RTM RTH	230.00
SDO-N	Rear Trail Hitch for 18 to 20 blade units		RTM RTH	270.00
SDO-Q	RTM Toolbar Attachment		RTM	520.00
DRT-L012	Dirt Diverters (pair) for 16 & 18 blade models		RTM RTH	485.00
DRT-L312	Dirt Diverters (pair) for 12 & 14 blade models		RTM RTH	500.00
SDO-V	Dirt Diverter Extensions (pair)	TSN	RTM RTH	165.00
DRT-M	Cane Deflectors (pair)	TSN	RTM RTH	210.00
RTM-L	High Lift 3pt. hitch in lieu of standard (for RTM disc)		RTM	155.00

VINEYARD DISC PRICE LIST

3PT. REVERSIBLE TANDEM - SUPER HEAVY DUTY



Shown with dirt diverters, and cane deflectors

RTH MODEL

Assembly charge - n/c

MODEL NO.	# of Blades	Width of Cut	Frame Width	Blade Size	Blade (front/rear)	Base Wt.	PRICE
RTH12	12	53" to 66"	60"	24" x 6mm	smooth / smooth	2,075 lbs.	\$ 11,700.00
RTH12-NS	12	53" to 66"	60"	24" x 6mm	notched / smooth	2,069	11,750.00
RTH12-NN	12	53" to 66"	60"	24" x 6mm	notched / notched	2,063	11,795.00
RTH14	14	63" to 84"	66"	24" x 6mm	smooth / smooth	2,235	12,570.00
RTH14-NS	14	63" to 84"	66"	24" x 6mm	notched / smooth	2,229	12,605.00
RTH14-NN	14	63" to 84"	66"	24" x 6mm	notched / notched	2,221	12,645.00
RTH16N	16	63" to 84"	66"	24" x 6mm	smooth / smooth	2,343	13,245.00
RTH16N-NS	16	63" to 84"	66"	24" x 6mm	notched / smooth	2,336	13,295.00
RTH16N-NN	16	63" to 84"	66"	24" x 6mm	notched / notched	2,327	13,345.00
RTH16W	16	63" to 101"	86"	24" x 6mm	smooth / smooth	2,431	13,400.00
RTH16W-NS	16	63" to 101"	86"	24" x 6mm	notched / smooth	2,423	13,460.00
RTH16W-NN	16	63" to 101"	86"	24" x 6mm	notched / notched	2,415	13,510.00
RTH18	18	81" to 119"	86"	24" x 6mm	smooth / smooth	2,500	14,090.00
RTH18-NS	18	81" to 119"	86"	24" x 6mm	notched / smooth	2,492	14,125.00
RTH18-NN	18	81" to 119"	86"	24" x 6mm	notched / notched	2,482	14,180.00
RTH20	20	81" to 119"	86"	24" x 6mm	smooth / smooth	2,570	14,635.00
RTH20-NS	20	81" to 119"	86"	24" x 6mm	notched / smooth	2,560	14,685.00
RTH20-NN	20	81" to 119"	86"	24" x 6mm	notched / notched	2,550	14,750.00

Reversible, 1-3/4" round axles, trunnion bearings w/ wear plates, 9" blade spacing, Cat II, Cat II quick hitch, middle buster, 0-30 degree gangs & tapered frame design.

OPTIONS - RTH 3PT. DISC

PART NO.	DESCRIPTION	For Model #			PRICE
DBEOR246	Blade Extensions, rear outside w/ 24" x 6mm blade (pr.)			RTH	\$ 655.00
DBEOF246	Blade Extensions, front outside w/ 24" x 6mm blade (pr.)			RTH	655.00
DTS-12	Mud scraper blade set - 12 blade unit	TSN	RTM	RTH	1,005.00
DTS-14	Mud scraper blade set - 14 blade unit		RTM	RTH	1,115.00
DTS-16	Mud scraper blade set - 16 blade unit		RTM	RTH	1,255.00
DTS-18	Mud scraper blade set - 18 blade unit		RTM	RTH	1,435.00
DTS-20	Mud scraper blade set - 20 blade unit			RTH	1,580.00
DTS-SEK	Scraper arm & blade ass'y w/ scraper extension (one pair)	TSN	RTM	RTH	210.00
SDO-R	Rear Trail Hitch for 12 to 16 blade units	TSN	RTM	RTH	230.00
SDO-N	Rear Trail Hitch for 18 to 20 blade units		RTM	RTH	270.00
SDO-P	RTH Toolbar Attachment			RTH	510.00
DRT-L012	Dirt Diverters (pair) for 16, 18 & 20 blade models	TSN	RTM	RTH	485.00
DRT-L312	Dirt Diverters (pair) for 12 & 14 blade models	TSN	RTM	RTH	500.00
SDO-V	Dirt Diverter Extensions (pair)	TSN	RTM	RTH	165.00
DRT-M	Cane Deflectors (pair)	TSN	RTM	RTH	210.00
RTH-L	High Lift 3pt. hitch in lieu of standard (for RTH disc)			RTH	155.00

VINEYARD DISC PRICE LIST

PULL TYPE TANDEM DISC - MEDIUM



Shown w/
notched blades

PTM MODEL

Assembly charge - n/c

MODEL NO.	# of Blades	Width of Cut	Frame Width	Blade Size	Blade Type	Base Wt.	PRICE
PTM12	12	4'2" - 5'6"	60"	24" x 5mm	smooth / smooth	2,378 lbs.	\$ 17,020.00
PTM12-NS	12	4'2" - 5'6"	60"	24" x 5mm	notched / smooth	2,372	17,055.00
PTM12-NN	12	4'2" - 5'6"	60"	24" x 5mm	notched / notched	2,366	17,100.00
PTM14	14	5'3" - 7'0"	66"	24" x 5mm	smooth / smooth	2,508	17,980.00
PTM14-NS	14	5'3" - 7'0"	66"	24" x 5mm	notched / smooth	2,502	18,025.00
PTM14-NN	14	5'3" - 7'0"	66"	24" x 5mm	notched / notched	2,494	18,080.00
PTM16N	16	5'3" - 7'0"	66"	24" x 5mm	smooth / smooth	2,600	18,765.00
PTM16N-NS	16	5'3" - 7'0"	66"	24" x 5mm	notched / smooth	2,593	18,840.00
PTM16N-NN	16	5'3" - 7'0"	66"	24" x 5mm	notched / notched	2,584	18,875.00
PTM16W	16	5'3" - 8'5"	86"	24" x 5mm	smooth / smooth	2,664	19,195.00
PTM16W-NS	16	5'3" - 8'5"	86"	24" x 5mm	notched / smooth	2,656	19,245.00
PTM16W-NN	16	5'3" - 8'5"	86"	24" x 5mm	notched / notched	2,648	19,315.00
PTM18	18	6'9" - 9'11"	86"	24" x 5mm	smooth / smooth	2,783	19,710.00
PTM18-NS	18	6'9" - 9'11"	86"	24" x 5mm	notched / smooth	2,773	19,765.00
PTM18-NN	18	6'9" - 9'11"	86"	24" x 5mm	notched / notched	2,765	19,825.00
1-3/4" round axles, trunnion bearings w/ wear plates, middle buster, 0-30 degree gangs, 9" blade spacing, hydraulic depth control & tapered frame design. Lead hoses included.							

OPTIONS - PTM PULL TYPE DISC

PART NO.	DESCRIPTION			PRICE
DBEOR245	Blade Extensions, rear outside w/ 24" x 5mm blade (pr.)	PTM		\$ 615.00
DBEOF245	Blade Extensions, front outside w/ 24" x 5mm blade (pr.)	PTM		615.00
DTS-12	Mud scraper blade set - 12 blade unit	PTM	PTH	1,005.00
DTS-14	Mud scraper blade set - 14 blade unit	PTM	PTH	1,115.00
DTS-16	Mud scraper blade set - 16 blade unit	PTM	PTH	1,255.00
DTS-18	Mud scraper blade set - 18 blade unit	PTM	PTH	1,435.00
DTS-SEK	Scraper arm & blade ass'y w/ scraper extension (one pair)	TSN	RTM	210.00
SDO-R	Rear Trail Hitch for 12 to 16 blade units	PTM		230.00
SDO-N	Rear Trail Hitch for 18 to 20 blade units	PTM		270.00
SDO-P	RTH, PTM, PTH Toolbar Attachment	PTM	PTH	510.00
DRT-L012	Dirt Diverters (pair) for 16 & 18 blade models	PTM	PTH	485.00
DRT-L312	Dirt Diverters (pair) for 12 & 14 blade models	PTM	PTH	500.00
SDO-V	Dirt Diverter Extensions (pair)	PTM	PTH	165.00
DRT-M	Cane Deflectors (pair)	PTM	PTH	210.00

1 800 288-8128 Order Desk

VINEYARD DISC PRICE LIST

PULL TYPE TANDEM DISC - HEAVY



Shown with notched blades

PTH MODEL

Assembly charge - n/c

MODEL NO.	# of Blades	Width of Cut	Frame Width	Blade Size	Spacing	Base Wt.	PRICE
PTH-12-24	12	4'2" - 5'6"	60"	24" x 6mm	9"	3,378 lbs.	\$ 18,425.00
PTH-14 -24	14	5'3" - 7'0"	66"	24" x 6mm	9"	3,508	19,350.00
PTH-16N-24	16	5'3" - 7'0"	66"	24" x 6mm	9"	3,600	20,050.00
PTH-16W-24	16	5'3" - 8'5"	86"	24" x 6mm	9"	3,664	20,805.00
PTH-18-24	18	6'9" - 9'11"	86"	24" x 6mm	9"	3,783	21,020.00
PTH-20-24	20	6'9" - 9'11"	86"	24" x 6mm	9"	3,900	21,390.00
PTH-12-26	12	4'2" - 5'6"	60"	26" x 6mm	9"	3,498	18,280.00
PTH-14 -26	14	5'3" - 7'0"	66"	26" x 6mm	9"	3,648	19,240.00
PTH-16N-26	16	5'3" - 7'0"	66"	26" x 6mm	9"	3,760	20,150.00
PTH-16W-26	16	5'3" - 8'5"	86"	26" x 6mm	9"	3,824	20,765.00
PTH-18-26	18	6'9" - 9'11"	86"	26" x 6mm	9"	4,143	21,050.00
PTH-20-26	20	6'9" - 9'11"	86"	26" x 6mm	9"	4,100	21,315.00

1-3/4" round axles, trunnion bearings w/ wear plates, middle buster, 0-30 degree gangs, 9" blade spacing, smooth blades, hydraulic depth control & tapered frame design. Lead hoses included. Notched blades are available

OPTIONS - PTH PULL TYPE DISC

PART NO.	DESCRIPTION			PRICE
NB246	24" x 6mm notched blades in lieu of smooth - each		PTH	\$ 10.00
NB266	26" x 6mm notched blades in lieu of smooth - each		PTH	15.00
DBEOR246	Blade Extensions, rear outside w/ 24" x 6mm blade (pr.)		PTH	655.00
DBEOF246	Blade Extensions, front outside w/ 24" x 6mm blade (pr.)		PTH	655.00
DBEOR266	Blade Extensions, rear outside w/ 26" x 6mm blade (pr.)		PTH	730.00
DBEOF266	Blade Extensions, front outside w/ 26" x 6mm blade (pr.)		PTH	730.00
DTS-12	Mud scraper blade set - 12 blade unit	PTM	PTH	1,005.00
DTS-14	Mud scraper blade set - 14 blade unit	PTM	PTH	1,115.00
DTS-16	Mud scraper blade set - 16 blade unit	PTM	PTH	1,255.00
DTS-18	Mud scraper blade set - 18 blade unit	PTM	PTH	1,435.00
DTS-20	Mud scraper blade set - 20 blade unit		PTH	1,580.00
DTS-SEK	Scraper arm & blade ass'y w/ scraper extension (one pair)	PTM	PTH	210.00
SDO-S	Rear Trail Hitch for PTH Models	PTM	PTH	255.00
SDO-P	RTH, PTM, PTH Toolbar Attachment	PTM	PTH	510.00
DRT-L012	Dirt Diverters (pair) for 16, 18 & 20 blade models - 24" dia. blades	PTM	PTH	485.00
DRT-L312	Dirt Diverters (pair) for 12 & 14 blade models - 24" dia. blades	PTM	PTH	500.00
DRT-L014	Dirt Diverters (pair) for 16, 18 & 20 blade models - 26" dia. blades		PTH	500.00
DRT-L314	Dirt Diverters (pair) for 12 & 14 blade models - 26" dia. Blades		PTH	510.00
SDO-V	Dirt Diverter Extensions (pair)	PTM	PTH	165.00
DRT-M	Cane Deflectors (pair)	PTM	PTH	210.00

VINEYARD DRILL PRICE LIST

DRILLS & SEEDERS



VINEYARD DRILL (Double Disc Opener model)

MODEL NO.	Width	Drilling Range	# of Cups	Opener Spacing	Bushel Cap.	Base Wt.	PRICE
VD-36PW	40.5"	29" - 32"	5	7-1/4"	6	1,715 lbs.	\$ 11,255.00
VD-48PW	48"	36" - 42"	6	7-1/4"	8	1,754	12,535.00
VD-60PW	62"	51" - 58"	8	7-1/4"	10	1,895	14,910.00
VD-72PW	76"	65" - 72"	10	7-1/4"	12	1,987	17,100.00
VD-96PW	101"	91"	13	7-1/2"	16	2,900	24,970.00

Units include double disc openers, 2 x 13" presswheels, and walkboard.

NO-TILL DRILL

MODEL NO.	Width	Drilling Range	# of Cups	Opener Spacing	Bushel Cap.	Base Wt.	PRICE
VDNT-36PW	40.5"	29"	5	7-1/4"	6	2,165 lbs.	\$ 16,390.00
VDNT-48PW	48"	36"	6	7-1/4"	8	2,254	18,530.00
VDNT-60PW	62"	51"	8	7-1/4"	10	2,495	22,570.00
VDNT-72PW	76"	65"	10	7-1/4"	12	2,687	26,420.00

OPTIONS

PART NO.	DESCRIPTION	PRICE
SS-36	Small Seed Attachment - for 36" unit	\$ 4,225.00
SS-48	Small Seed Attachment - for 48" unit	4,330.00
SS-60	Small Seed Attachment - for 60" unit	4,475.00
SS-72	Small Seed Attachment - for 72" unit	4,600.00
NG-36	Native Grass Attachment - for 36" unit	6,325.00
NG-48	Native Grass Attachment - for 48" unit	6,505.00
NG-60	Native Grass Attachment - for 60" unit	6,675.00
NG-72	Native Grass Attachment - for 72" unit	6,800.00
NT-36ATT10	No-Till Attachment - 36" - bolts on existing base unit	6,240.00
NT-48ATT10	No-Till Attachment - 48" - bolts on existing base unit	7,090.00
NT-60ATT10	No-Till Attachment - 60" - bolts on existing base unit	8,805.00
NT-72ATT10	No-Till Attachment - 72" - bolts on existing base unit	10,720.00
VD-TDH	Tandem Drill Hitch (must specify drill combination)	3,995.00

Visit our website @ www.tgschmeiser.com

HARVEST EQUIPMENT PRICE LIST

BIN TRAILERS



HBT3N - 3 BIN NARROW



HBT4S - 4 BIN STANDARD

- * Made annually with an 8/1 delivery
- * Minimum order quantity of 10 if ordered out of season. Call factory for details

BIN TRAILERS

Assembly charge - N/A

MODEL NO.	DESCRIPTION	WEIGHT	PRICE
HBT2N	2 Bin Narrow Trailer - Tires Mounted Inside of Frame	690	\$ 4,905.00
HBT2NR	2 Bin Narrow Trailer with Ramps	725	5,360.00
HBT2S	2 Bin Standard Trailer - Tires Mounted Outside of Frame	775	5,220.00
HBT2SPF	2 Bin Standard w/ Platform & Fender Kit	950	6,170.00
HBT3S	3 Bin Standard Trailer - Tires Mounted Outside of Frame	1,160	5,660.00
HBT3N	3 Bin Narrow Trailer - Tires Mounted Inside of Frame	1,000	5,515.00
HBT3SPF	3 Bin Standard w/ Platform & Fender Kit	1,300	6,695.00
HBT4S	4 Bin Standard Trailer - Tires Mounted Outside of Frame	1,230	6,255.00
HBT4SPF	4 Bin Standard Trailer w/ Platform & Fender Kit	1,400	7,510.00
HBTFK	Fender kit for standard units only	50	430.00

Standard Accessories: Jack Stand. Operator controlled, spring-loaded quick release with Auto-Relatch.
Adjustable and spring-loaded rear bin stops. Removable spindles. Greasable and replaceable trailer pivot pins

ORDERS@TGSCHMEISER.COM

T. G. SCHMEISER CO., INC.

Contact Information

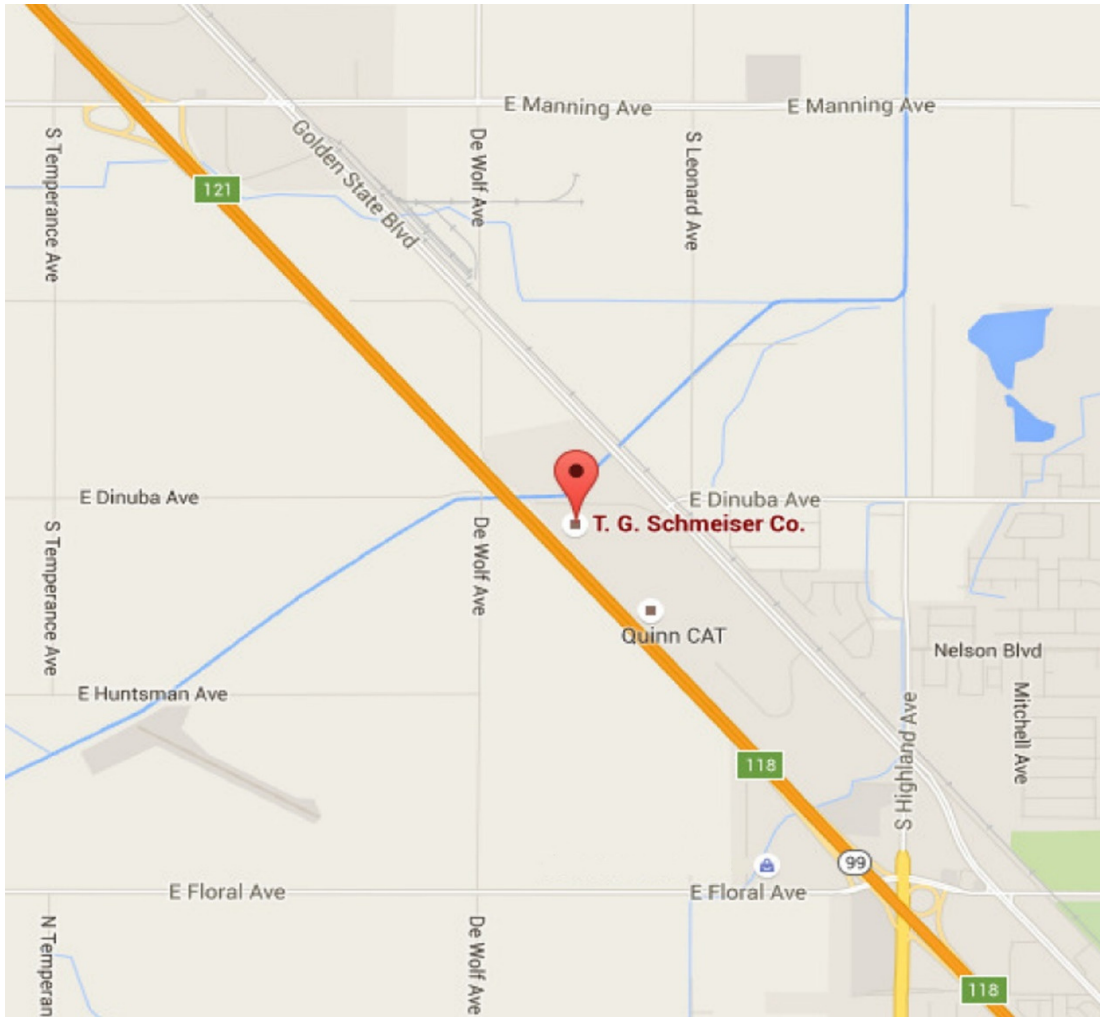

PLANT ADDRESS - 8135 E. DINUBA AVE., SELMA, CA 93662

MAILING ADDRESS - P.O. BOX 1392, SELMA, CA 93662

1 (800) 288-8128

TGSchmeiser.com

Hours of Business

Shipping and Receiving: 8am to 4:30pm

Office Hours:

We are closed for lunch 12pm to 12:30pm

Please Note: Truckload shipments must arrive for loading prior to 3pm

ITEMS MAY BE SUBJECT TO A POTENTIAL TARIFF CHARGE



2024 Pricing held for 2025

MAY-BRIDGE HERSE A CHAINES/PACAGE [May-Bridge Chain Harrows]

Bridge Harrows

Measurement from Draw Bar to back is 86"

Model #	# of Hooks	Working Width	Harrow with Bar		Harrow without Bar		Draw Bar	Colour Code
			Weight (lbs)	Price \$151.00/ft	Weight (lbs)	Price \$116.00/ft	Price \$35.00/ft	
B5	3	4' 4"	145	757.00	130	\$582.00	\$175.00	
B7	5	6' 6"	220	\$1,060.00	195	\$815.00	\$245.00	Grey
B9	7	8' 8"	290	\$1,363.00	255	\$1,048.00	\$315.00	Yellow
B11	9	10' 10"	370	\$1,666.00	320	\$1,280.00	\$385.00	Black
B13	11	13'	450	\$1,968.00	380	\$1,513.00	\$455.00	Blue
B15	13	15' 2"	525	\$2,271.00	445	\$1,746.00	\$525.00	Green
B17	15	17' 4"	610	\$2,574.00	510	\$1,979.00	\$596.00	White
B19	17	19' 6"	695	\$2,877.00	570	\$2,211.00	\$666.00	Purple
B22	19	21' 8"	825	\$3,331.00	700	\$2,561.00	\$771.00	Yellow-White
B24	21	23' 10"	920	\$3,634.00	760	\$2,793.00	\$841.00	Blue-White
B26	23	26'	1050	\$4,444.00	900	\$3,026.00	\$1,418.00	Green-White

*Note: B26 consists of two B13 Harrows with Bar (\$3,937.00) plus a lead bar (\$507.00) for a total of \$4,444.00

Bridge Long Harrows

Measurement from Draw Bar to back is 114"

Model #	# of Hooks	Working Width	Harrow with Bar		Harrow without Bar		Draw Bar	Colour Code
			Weight (lbs)	Price \$214.00/ft	Weight (lbs)	Price \$179.00/ft	Price \$35.00/ft	
B9 L	7	8' 8"	398	\$1,922.00	363	\$1,607.00	\$315.00	Yellow
B11 L	9	10' 10"	502	\$2,349.00	452	\$1,964.00	\$385.00	Black
B13 L	11	13'	606	\$2,776.00	536	\$2,321.00	\$455.00	Blue
B15 L	13	15' 2"	705	\$3,204.00	625	\$2,678.00	\$525.00	Green
B17 L	15	17' 4"	852	\$3,631.00	777	\$3,035.00	\$596.00	White
B19 L	17	19' 6"	966	\$4,058.00	881	\$3,392.00	\$666.00	Purple

To confirm harrow size, refer to number of hooks on harrow (all are odd numbers) and number of loops on draw bar.

Note: HST applies to Model B5 and B7. All other models are zero rated.

PRICED IN CANADIAN DOLLARS

FOB BELWOOD – DESIGN & PRICE ARE SUBJECT TO CHANGE WITHOUT NOTICE



2024 Pricing held for 2025

MAY-BRIDGE HERSE A CHAINES/PACAGE
[May-Bridge Chain Harrows]

Model #	Working Width	Transport Width	Approx. Weight (lbs)	Complete Caddy	Caddy with Harrow
2M15	15' 2"	8' 6"	730	\$10,784.00	\$12,534.00
2M17	17' 4"	8' 6"	770	\$10,912.00	\$12,891.00
2M19	19' 6"	8' 6"	830	\$11,106.00	\$13,317.00
2M22	21' 8"	8' 6"	930	\$11,265.00	\$13,826.00
2M24	21' 10"	8' 6"	990	\$11,499.00	\$14,292.00
2M26	26'	8' 6"	1,050	\$11,758.00	\$14,784.00

FOR LARGER CARRIERS PLEASE CALL FOR PRICING

3-Point Hitch Lift Frame

(makes use of the regular harrow draw bar & also requires top link)

Model #	Working Width	Transport Width	Complete Lift Frame	Lift Frame w/ Harrow & Draw Bar
M7	6' 6"	5'	\$1,257.00	\$2,317.00
M9	8' 8"	7'	\$1,257.00	\$2,619.00
M11	10' 10"	9'	\$1,396.00	\$3,061.00
M13	13'	11' 6"	\$1,396.00	\$3,364.00

Note: HST applies to Model M7. All other models are zero rated.

PRICED IN CANADIAN DOLLARS

FOB BELWOOD – DESIGN & PRICE ARE SUBJECT TO CHANGE WITHOUT NOTICE



2024 Pricing held for 2025

MAY-BRIDGE HERSE A CHAINES/PACAGE
[May-Bridge Chain Harrows]

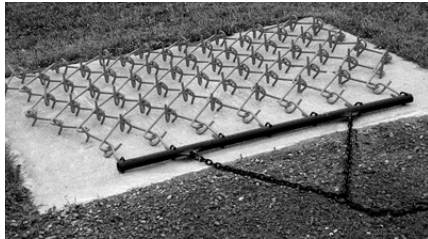

Bridge Estate Harrows

- Includes draw bar \$473.00
- 5 foot working width + tax
- From drawbar to back is 50"
- 1/2" 1045 Hard Steel
- Shipping weight: 95 lbs
- Shipping dimensions: 60" L x 16" W x 6" H

- Includes draw bar \$698.00
- 6' 6" working width + tax
- From drawbar to back is 50"
- 1/2" 1045 hard steel
- Shipping weight: 125 lbs.
- Shipping dimensions: 78" L x 16" W x 6" H

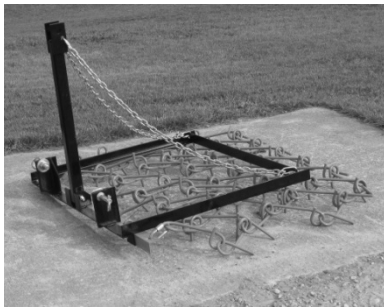

3-Point Hitch Lift Frame

- For 5' Estate Harrow Without Harrow 440.00
- Shipping weight: 70 lbs + tax
- Shipping dimensions: 41" L x 10" W x 6" H

- For 6' 6" Estate Harrow Without Harrow \$576.00
- Shipping weight: 120 lbs. + tax
- Shipping dimensions: 52" x 10" x 6"

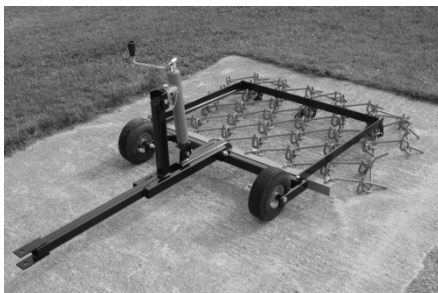

Wheeled Carrier

- Without harrow \$1,107.00
- Shipping weight: 98 lbs + tax
- Shipping dimensions: 41" L x 16" W x 16" H

www.maybridgeharrows.com
info@maybridgeharrows.com

PRICED IN CANADIAN DOLLARS

FOB BELWOOD – DESIGN & PRICE ARE SUBJECT TO CHANGE WITHOUT NOTICE

5808 Hwy #9, Harriston, Ontario, N0G 1Z0
Phone: 519-338-2923, Fax: 519-338-2756
Email: sales@harcoag.ca
www.harcoag.ca



Sept 2025-RUL120 removed

DEL MORINO ROTARY TILLERS, LAWN ROLLERS



TANGO	Standard Features
	<ul style="list-style-type: none"> ▪ Cat 1 three point hitch ▪ Aluminum gearbox 540 rpm ▪ 4 tines per row ▪ Shear bolt PTO shaft cat 2

Model #	Working Width	Engine HP	Wt (lbs)	Price (Cdn)
Tango 105	42"	12 – 30	290	\$1,977.00
Tango 125	50"	12 – 30	308	\$2,061.00

FLASH	Standard Features
	<ul style="list-style-type: none"> ▪ Cat 1 three point ▪ 2 corner gearboxes, shear bolt protection ▪ 4 tines per flange ▪ Adjustable skid shoes ▪ Cat 1 PTO shaft

Model #	Working Width	Engine HP	Wt (lbs)	Price (Cdn)
Flash 85	34"	12 – 25	260	\$2,260.00
Flash 96	38"	12 – 25	282	\$2,337.00
Flash 105	42"	12 – 25	287	\$2,369.00
Flash 125	50"	12 – 25	309	\$2,446.00

PRICED IN CANADIAN DOLLARS

PRICES ARE FOB HARRISTON, ONTARIO – DESIGN & PRICE ARE SUBJECT TO CHANGE WITHOUT NOTICE

5808 Hwy #9, Harriston, Ontario, N0G 1Z0
Phone: 519-338-2923, Fax: 519-338-2756
Email: sales@harcoag.ca
www.harcoag.ca



Sept 2025-RUL120 removed

DEL MORINO ROTARY TILLERS, LAWN ROLLERS

EAGLE	Standard Features
	<ul style="list-style-type: none"> ▪ Cat 1 three point ▪ Cast iron gearbox ▪ 6 tines per row ▪ Cat 4 PTO with slip clutch

Model #	Working Width	Engine HP	Wt (lbs)	Price (Cdn)
Eagle 125-ZF	50"	12 – 50	414	\$3,323.00
Eagle 165-ZF	62"	12 – 50	492	\$3,691.00

URT – HF	Standard Features
	<ul style="list-style-type: none"> ▪ Cat 2 three point ▪ Cast iron gearbox ▪ 100 series drive chain – oil bath ▪ 6 tines per flange ▪ Adjustable skid shoes ▪ Series 4 PTO with slip clutch

Model #	Working Width	Engine HP	Wt (lbs)	Price (Cdn)
URT-HF 150	59"	30 – 70	640	\$4,948.00
URT-HF 168	67"	30 – 70	705	\$5,110.00
URT-HF 186	71"	30 – 70	728	\$5,344.00
URT-HF 204	81"	30 – 70	798	\$5,988.00
URT-HF 222	87"	30 – 70	840	\$6,212.00

'Other models available, call for pricing'

PRICED IN CANADIAN DOLLARS

PRICES ARE FOB HARRISTON, ONTARIO – DESIGN & PRICE ARE SUBJECT TO CHANGE WITHOUT NOTICE



5808 Hwy #9, Harriston, Ontario, N0G 1Z0
Phone: 519-338-2923, Fax: 519-338-2756
Email: sales@harcoag.ca
www.harcoag.ca

Sept 2025-RUL120 removed

DEL MORINO ROTARY TILLERS, LAWN ROLLERS



HRA	Standard Features
	<ul style="list-style-type: none"> ▪ Cat 2 three point hitch ▪ Cast Iron gearbox 540 rpm ▪ 6 tines per row ▪ Universal PTO shaft cat 5 w/slip clutch ▪ Reinforced 3 PTO frame

Model #	Working Width	Engine HP	Wt (lbs)	Price (Cdn)
HRA 225	90"	50 – 95	1415	\$10,449.00
HRA 250	100"	50 – 95	1521	\$11,175.00

DEL MORINO LAWN ROLLERS

LAWN ROLLERS	Standard Features
	<ul style="list-style-type: none"> ▪ Cat 1 & 2, 3 Point ▪ Scraper ▪ Water tight for filling ▪ 15.75" diameter (400mm)

Model #	Working Width	Engine HP	Wt (lbs)	Price (Cdn)
RUL-150	60"	20 – 50	243	\$1,610.00
RUL-170	68"	20 – 50	276	\$1,772.00

Discounted Item – Contact us for exclusive pricing.

PRICED IN CANADIAN DOLLARS

PRICES ARE FOB HARRISTON, ONTARIO – DESIGN & PRICE ARE SUBJECT TO CHANGE WITHOUT NOTICE

ATHENS

EFFECTIVE JANUARY, 2025

Please Note: Commencing January 2025 a surcharge of 10% applies to this current 2025 price list due to discount structure.



WHOLEGOODS PRICE LIST



5808 Hwy #9, Harriston, Ontario, N0G 1Z0
519-338-2923, sales@harcoag.ca
www.harcoag.ca

ATHENS PLOW COMPANY, INC.
P.O. BOX 609
ATHENS, TENNESSEE 37371-0609
TELEPHONE 423-744-PLOW (7569)
WATS 1-800-535-3852
FAX 1-423-744-7218

WWW.ATHENSPLOW.COM

TERMS AND DISCOUNTS FOR WHOLEGOODS ATHENS PLOW COMPANY, INC.

Eligible Items:

Items eligible for Wholegoods Discounts are serial-numbered units and extra equipment accessories ordered with or for that unit.

Trade Discount for Eligible Wholegoods Items:

- Regular Open Account – 25%
- Preseason (90 days) – 25%

Cash Discounts:

- A. Regular Open Account - 5% if paid 30 days from date of invoice. Net 31.
- B. Regular Preseason - 10% if paid 30 days from date of invoice. Net 31.
- C. Volume Discount:
 - a) 5% extra cash discount for orders more than \$100,000 (open account) @ list, if paid 30 days from date of invoice.
 - b) 5% extra cash discount for additional wholegoods for the remainder of the calendar year.
- D. No discount will be allowed on current invoices if any invoices are past due.
- E. Government Agency Discount applies to all units. Government Agency Discount is an additional 5% (Maximum discount of 5% Cash and Government). Government discount applies if paid 30 days from date of invoice. A copy of the Government Purchase Order must accompany the dealer remittance to earn the special discount. Eligible agencies include any department of Federal, State, County or City Government, Soil Conservation, Fish and/or Wildlife, Drainage and Water Districts.

GENERAL STATEMENTS AS TO TERMS AND DISCOUNTS

No cash discount is allowed on warranty pending items.

Payment is due immediately for retailed units: units that have been removed from dealer's main place of business, items that have been used or not adequately protected against devaluation, or due date of invoice, whichever is earlier.

Past due invoices are subject to a 1.5% per month interest charge or the maximum allowable per law, whichever is less.

It is the dealer's responsibility to see that discounted payments reach our office on or before the due dates specified to receive discounts.

All prices are F.O.B. Athens Plow Company.

RETURNED GOODS

WHOLEGOODS

Returns must be approved by Athens Plow Co., Inc. When approved for return, the dealer must prepay shipping costs. Credit will be issued at original invoice amount less applicable cash discount. There will be a restocking charge of 20%.

MERCHANDISE RECEIPT

Any variation between items ordered and shipped and actual items received must be reported to Athens Plow as soon as the variation is recognized and no later than 30 days after receipt of shipment.

All shipments are made F.O.B. our Shipping Dock. All claims regarding the errors, shortages, and/or damages in shipment are the responsibility of the consignee and should be filed with the delivering carrier.

WARRANTY POLICY GUIDE ATHENS PLOW COMPANY, INC.

A. The Purpose of Warranty

Warranty assures the purchaser that should a defect in material or workmanship occur during the warranty period, Athens Plow Company, Inc. will assume specific repair responsibilities, as listed in the warranty statement. The warranty statement is to be provided to each purchaser of each piece of new equipment. Warranty begins on the date the product is delivered to the original purchaser of the product. Once the warranty period has begun, it cannot be stopped or interrupted.

B. Dealer Responsibilities

The following responsibilities are to be performed when the dealer delivers a product to the purchaser or otherwise places it into warranty service:

1. Complete the Warranty Registration Form and forward to Athens Plow Company, Inc. within 30 days of the sale of the product. Warranty reimbursement is contingent upon product registration.
2. Review warranty statement, operator's manual, and complete delivery report with purchaser to assure understanding of purchaser's responsibilities as related to warranty, service, and the proper and safe operation of the product. The purchaser should be advised to have failed parts repaired or replaced immediately upon failure and that continued use will result in additional damage and excessive wear.
3. Contact the manufacturer prior to beginning repair or replacement of failed parts to make certain that the cost of repairs are consistent with the value of the product when sold. Warranty requests for units in dealer's inventory may be submitted to Athens Plow Company, Inc. when defects are noted in the product prior to the retail sale of that unit.
4. Provide warranty and service repairs as directed by Athens Plow Company, Inc. instructions.
5. All warranty work must be completed within 30 days of failure. Notify Athens Plow Company, Inc. if repairs will require more than 30 days after failure for an extension. No claim will be accepted for warranties that exceed this 30-day period.
6. No warranty will be allowed on units delivered to the retail customer prior to the full payment of that unit to the manufacturer by the dealer.
7. If diagnostic time is required, contact Athens Plow Company, Inc. prior to beginning the warranty repair for approval. Travel time reimbursement must be approved by Athens Plow Company, Inc. prior to beginning the warranty repair.

C. Athens Plow Company's Responsibilities

1. Reimbursement for parts used in warranty repair will be credited only when the parts are purchased from Athens Plow Company, Inc. Parts will be credited at dealer's net cost. No warranty will be allowed on parts that are past due.
2. Dealer should use parts from their parts inventory first. In the event that parts must be shipped from Athens Plow Company, Inc., freight will be paid for by Athens Plow Company, Inc. and will be shipped by the most economical means to arrive in the shortest possible time. Air, Next Day Air, Priority, and other special shipment methods requested by the dealer will be at the customer's expense.
3. Warranty Labor Reimbursement for labor expense to the dealer is made by payment of \$50.00 per shop hour. Repair times will be reviewed by Athens Plow Company, Inc. and may be adjusted to average repair time required by other dealers to make similar repairs.
4. Reimbursements for repairs made by outside sources (not dealer personal) will be made for those services deemed necessary for the resolution of the warranty by Athens Plow Company, Inc. Outside repair invoices must have approval from Athens Plow Company, Inc. and must be attached to the warranty claim after approval.

D. Other Warranty Provisions

The following guidelines are to be followed when performing warranty repairs:

1. In all cases, the most economical repair should be performed unless otherwise directed. Credit will not be allowed for assemblies if it is practical to make the repair with individual parts. In some cases, the assembly price may be less than the total of the parts and labor required to complete the repair. In those cases, an assembly may be used.
2. Only those parts provided by Athens Plow Company, Inc. are covered under warranty. The use of parts from other sources will not be eligible for warranty consideration.
3. All parts removed during warranty repair should be held for a period of 60 days after the warranty claim has been submitted to Athens Plow Company, Inc. These parts can be discarded if the return request has not been made during this period. Parts that are returned upon request to Athens Plow Company, Inc. for which credit has not been issued can be returned upon dealer request within 30 days of claim disposition. These parts will be discarded after the 30-day period.
4. Athens Plow Company, Inc. reserves the right to deny or reverse all warranty claims for parts, labor, or miscellaneous charges when errors are found, warranty provisions are abused, or fraudulent claims are submitted.

5. Warranty reimbursement is not possible:
 - a. If parts returned are not cleaned and properly identified, or if they are damaged in return shipment due to poor packaging.
 - b. When failure falls under the "limitations" as identified in the Warranty Statement.
 - c. When Athens Plow Company, Inc. has requested the return of certain parts, assemblies, or information and has not received material within 30 days of date posted on return request.
 - d. On claims due to damage or shortage that are obviously the responsibility of the dealer or the delivering carrier.
 - e. On the entire claim when the warranty policy and provisions are not followed.

All dealers will warranty their technician's work to the purchaser and will indemnify Athens Plow Company Inc. from all such claims.

E. Use of Photos

Pictures should be attached to the dealer's claim when their inclusion will help identify the condition of the part being repaired or replaced, and thus assisting in the approval of the claim. In some cases, the use of photos may eliminate the need to return parts for evaluation. Photos will not be returned unless specifically requested.

F. Delayed Warranty Repairs

Warranty repairs should be scheduled and performed as soon as possible after notification to dealer and Athens Plow Company, Inc. There may be circumstances that require the use of the product for a short period of time by the retail customer or the availability of repair parts necessary to complete the repairs will require the work to extend past the 30-day period. In those cases, the dealer must notify Athens Plow Company, Inc. of the extenuating circumstance and advise that the continued use of the product will not enlarge the warranty claim. These claims will then be processed as if the product is still within the warranty period.

G. Denied Claims

Dealers will be notified of a denied claim that will state the reason for the denial. The dealer has the right to appeal this claim and must do so within 30 days of notification of denial. If there has been no appeal within the 30-day period, the Claim will be considered closed.

LIMITED WARRANTY STATEMENT

Athens Plow Company, Inc. warrants each new Athens Plow Company, Inc. product to be free from defects in material and Workmanship. This warranty is applicable only for the normal service life expectancy of the product or components, not to exceed twelve consecutive months from the date of delivery of the new Athens Plow Company, Inc. product to the original purchaser. Athens Plow Company, Inc. reserves the right to make improvements in design or changes in specifications at any time, without incurring any obligation to owners of units previously sold.

Our obligation under this warranty shall be limited to repairing or replacing, free of charge to the original purchaser, any part that, in our judgment, shall show evidence of such defect, provided further that such part shall be returned within thirty (30) days from date of failure to Athens Plow Company, Inc., routed through the dealer from whom the purchase was made, transportation charges prepaid.

This warranty shall not be interpreted to render Athens Plow Company, Inc. liable for injury or damages of any kind or nature to person or property. This warranty does not extend to the loss of crops, loss because of delay in harvesting, or any expense or loss incurred for labor, substitute machinery, rental or for any other reason. Except as set forth above, Athens Plow Company, Inc. shall have no obligation or liability of any kind on account of any of its equipment and shall not be liable for special or consequential damages. Athens Plow Company, Inc. makes no other warranty, expressed or implied, and, specifically, Athens Plow Company, Inc. disclaims any implied warranty or merchantability or fitness for a particular purpose. Some states or provinces do not permit limitations or exclusions of implied warranties or incidental or consequential damages, so the limitations or exclusions in this warranty may not apply.

This warranty is subject to any existing conditions of supply which may directly affect our ability to obtain materials or manufacture replacement parts.

No one is authorized to alter, modify, or enlarge this warranty nor the exclusion, limitations, and reservations.

TABLE OF CONTENTS

MODEL NUMBER	PAGE
LIFT TYPE DISK HARROWS	
MODEL BBD5	1
MODEL 37	2
MODEL 47	3
MODEL 52	5
MODEL 55	7
MODEL 65	10
MODEL 66	12
PULL TYPE DISK HARROWS	
Tandem	
MODEL 62	15
MODEL 93	26
MODEL 153	29
Double Offsets	
MODEL 76	19
MODEL 77	23
MODEL 116	30
MODEL 119	33
Offsets	
MODEL 97	35
MODEL 107	37
MODEL 127	38
MODEL 167	41
MODEL 137	44
MODEL 187	46
MODEL 287	48
CHISEL PLOW	
MODEL 156	49
LEVEE PLOW	
MODEL 220	52

ATHENS BBD5/BBD6 LIFT-TYPE DISK HARROW

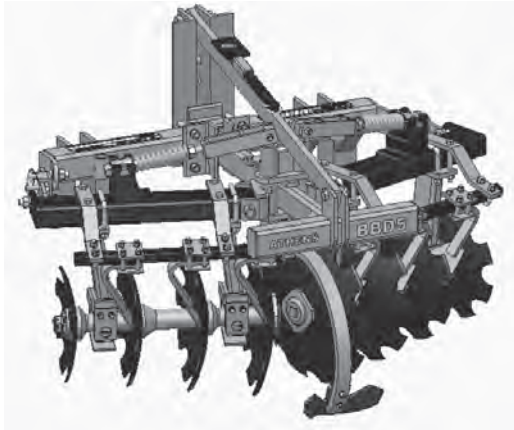

SPECIFICATIONS:

Cutting Width – 5' 0" & 6' 6"
 Disc Spacing – 9"
 Disc Diameter – 22" C/O Tapered
 Cat. II Free Link or Quick Coupler
 Relube Ball Bearings
 Rigid or Spring Bearing Hangers
 1 1/4" Cold Rolled Square Gang Axle
 with Gang Wrench
 Adjustable Angle of Cut 15° and 18°
 Heavy Duty Scrapers
 Balk Buster

<u>MODEL NUMBER</u>	<u>DISC DIAM</u>	<u>TYPE OF DISC</u>	<u>DISC THICK</u>	<u># OF DISC</u>	<u>DISC SPACING</u>	<u># OF BRGS</u>	<u>APX WT</u>	<u>SUGST PRICE</u>
<u>5' 0" WIDE</u>								
BBD5-0827-65T	22" Tap	C/O	.197	8	9"	4	985	\$5,740
<u>6' 6" WIDE</u>								
BBD6-1027-65T	22" Tap	C/O	.197	10	9"	4	1017	\$6,112

ATHENS 37 LIFT TYPE DISK HARROW

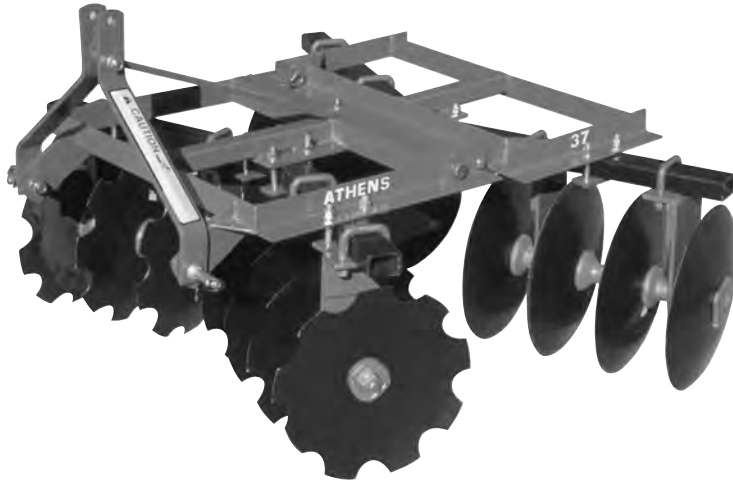

SPECIFICATIONS:

Cutting Width – 5' 2" to 6' 5"

Disc Spacing – 7", 9", or 9"F & 7"R

Discs – 18" Diameter, C/O or SM

STANDARD EQUIPMENT:

Category I Hitch

Adjustable Angle of Cut

1" High Carbon Steel Square Axles

Factory Assembled Gangs

Triple-Lip Sealed Ball Bearings

<u>MODEL NUMBER</u>	<u>DISC DIAM</u>	<u>TYPE OF DISC</u>		<u>DISC THCK</u>	<u># OF DISC</u>	<u>DISC SPACING</u>		<u># OF BRGS</u>	<u>APX WT</u>	<u>SUGST PRICE</u>
		<u>FRNT</u>	<u>REAR</u>			<u>FRNT</u>	<u>REAR</u>			
<u>5' 2" WIDE</u>										
037-1611-010	18"	C.O.	C.O.	.118	16	7"	7"	8	624	\$2,680
037-1611-110	18"	SM.	SM.	.118	16	7"	7"	8	640	\$2,671
037-1611-410	18"	C.O.	SM.	.118	16	7"	7"	8	632	\$2,660
<u>6' 3" WIDE</u>										
037-1621-010	18"	C.O.	C.O.	.118	16	9"	9"	8	654	\$2,732
037-1621-110	18"	SM.	SM.	.118	16	9"	9"	8	670	\$2,714
037-1621-410	18"	C.O.	SM.	.118	16	9"	9"	8	662	\$2,707
<u>6' 5" WIDE</u>										
037-1831-010	18"	C.O.	C.O.	.118	18	9"	7"	8	680	\$2,849
037-1831-110	18"	SM.	SM.	.118	18		7"	8	698	\$2,801
037-1831-410	18"	C.O.	SM.	.118	18	9"	7"	8	690	\$2,826
037-2011-010	18"	C.O.	C.O.	.118	20	7"	7"	8	702	\$2,968
037-2011-110	18"	SM.	SM.	.118	20	7"	7"	8	722	\$2,923
037-2011-410	18"	C.O.	SM.	.118	20	7"	7"	8	712	\$2,942

ATHENS 47 LIFT TYPE DISK HARROW

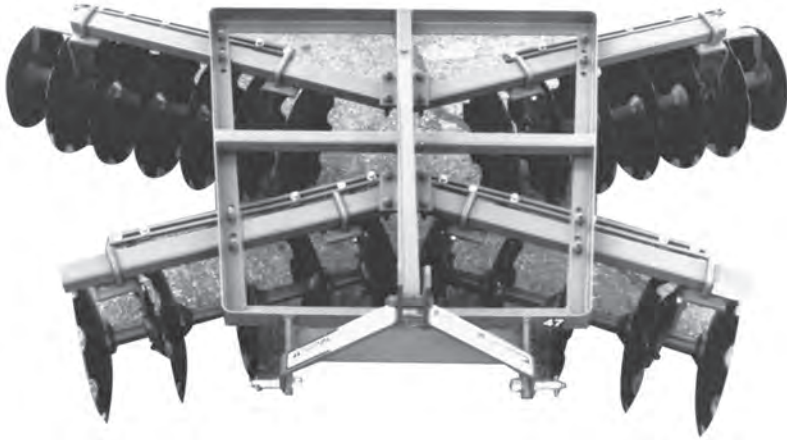

SPECIFICATIONS:

Cutting Width – 6' 3" to 7' 9"
 Disc Spacing – 7", 9", or 9"F & 7"R
 Discs - 18" or 20" – C/O or SM

STANDARD EQUIPMENT:

Category I Hitch
 Adjustable Angle of Cut
 1" High Carbon Square Axles
 Factory Assembled Gangs
 Triple Lip Sealed Ball Bearings

<u>MODEL NUMBER</u>	<u>DISC DIAM</u>	<u>TYPE OF DISC</u>		<u>DISC THCK</u>	<u># OF DISC</u>	<u>DISC SPACING</u>		<u># OF BRGS</u>	<u>APX WT</u>	<u>SUGST PRICE</u>
		<u>FRNT</u>	<u>REAR</u>			<u>FRNT</u>	<u>REAR</u>			
<u>6' 3" WIDE</u>										
047-1621-010	18"	C.O.	C.O.	.118	16	9"	9"	8	664	\$2,731
047-1621-020	20"	C.O.	C.O.	.138	16	9"	9"	8	712	\$2,950
047-1621-110	18"	SM.	SM.	.118	16	9"	9"	8	680	\$2,639
047-1621-120	20"	SM.	SM.	.118	16	9"	9"	8	712	\$2,870
047-1621-410	18"	C.O.	SM.	.118	16	9"	9"	8	672	\$2,680
047-1621-420	20"	C.O.	SM.	.138	16	9"	9"	8	712	\$2,911
<u>6' 5" WIDE</u>										
047-1831-010	18"	C.O.	C.O.	.118	18	9"	7"	8	690	\$2,860
047-1831-020	20"	C.O.	C.O.	.138	18	9"	7"	8	744	\$3,126
047-1831-110	18"	SM.	SM.	.118	18	9"	7"	8	708	\$2,698
047-1831-120	20"	SM.	SM.	.118	18	9"	7"	8	744	\$2,873
047-1831-410	18"	C.O.	SM.	.118	18	9"	7"	8	700	\$2,780
047-1831-420	20"	C.O.	SM.	.138	18	9"	7"	8	744	\$3,011
047-2011-010	18"	C.O.	C.O.	.118	20	7"	7"	8	712	\$2,946
047-2011-020	20"	C.O.	C.O.	.138	20	7"	7"	8	772	\$3,286
047-2011-110	18"	SM.	SM.	.118	20	7"	7"	8	732	\$2,822
047-2011-120	20"	SM.	SM.	.118	20	7"	7"	8	772	\$3,009
047-2011-410	18"	C.O.	SM.	.118	20	7"	7"	8	722	\$2,883
047-2011-420	20"	C.O.	SM.	.138	20	7"	7"	8	772	\$3,150

<u>MODEL NUMBER</u>	<u>DISC DIAM</u>	<u>TYPE OF DISC</u>		<u>DISC THCK</u>	<u># OF DISC</u>	<u>DISC SPACING</u>		<u># OF BRGS</u>	<u>APX WT</u>	<u>SUGST PRICE</u>
		<u>FRNT</u>	<u>REAR</u>			<u>FRNT</u>	<u>REAR</u>			
<u>7' 6" WIDE</u>										
047-2231-010	18"	C.O.	C.O.	.118	22	9"	7"	8	762	\$3,174
047-2231-020	20"	C.O.	C.O.	.138	22	9"	7"	8	828	\$3,489
047-2231-110	18"	SM.	SM.	.118	22	9"	7"	8	784	\$2,982
047-2231-120	20"	SM.	SM.	.118	22	9"	7"	8	828	\$3,186
047-2231-410	18"	C.O.	SM.	.118	22	9"	7"	8	773	\$3,066
047-2231-420	20"	C.O.	SM.	.138	22	9"	7"	8	828	\$3,218
047-2411-010	18"	C.O.	C.O.	.118	24	7"	7"	8	782	\$3,282
047-2411-020	20"	C.O.	C.O.	.138	24	7"	7"	8	854	\$3,626
047-2411-110	18"	SM.	SM.	.118	24	7"	7"	8	806	\$3,069
047-2411-120	20"	SM.	SM.	.118	24	7"	7"	8	854	\$3,289
047-2411-410	18"	C.O.	SM.	.118	24	7"	7"	8	794	\$3,175
047-2411-420	20"	C.O.	SM.	.138	24	7"	7"	8	854	\$3,457
<u>7' 9" WIDE</u>										
047-2021-010	18"	C.O.	C.O.	.118	20	9"	9"	8	737	\$2,946
047-2021-020	20"	C.O.	C.O.	.138	20	9"	9"	8	797	\$3,237
047-2021-110	18"	SM.	SM.	.118	20	9"	9"	8	757	\$2,775
047-2021-120	20"	SM.	SM.	.118	20	9"	9"	8	797	\$2,959
047-2021-410	18"	C.O.	SM.	.118	20	9"	9"	8	747	\$2,859
047-2021-420	20"	C.O.	SM.	.138	20	9"	9"	8	797	\$3,102

ATHENS 52 LIFT-TYPE TANDEM DISK HARROW



SPECIFICATIONS:

Cutting Width 6' 6", 7' 0", 7' 11", and 8' 2"

Disc Spacing 7 1/2", 9", or 9" F & 7 1/2" R

Disc Diameter 18" or 20" C/O or SM

Cat. I Free Link

Relube Ball Bearings

Flangette Bearing Hangers

1 1/8" Cold Rolled Square Gang Axle
with Gang Wrench

Adjustable Angle of Cut 15° and 18°

Heavy Duty Scrapers (Extra Equipment)

Cover Discs (Extra Equipment)

<u>MODEL NUMBER</u>	<u>DISC DIA</u>	<u>TYPE OF DISC</u> FRT REAR	<u>DISC THICK</u>	<u># OF DISC</u>	<u>DISC SPACING</u> FRT REAR	<u># OF BRGS</u>	<u>APX WT</u>	<u>SUGST PRICE</u>
<u>6' 6" WIDE</u>								
052-1622-211	18"	C/O C/O	.138	16	9" 9"	8	823	\$3,848
052-1622-311	18"	SM SM	.138	16	9" 9"	8	855	\$3,767
052-1622-511	18"	C/O SM	.138	16	9" 9"	8	839	\$3,799
052-1622-221	20"	C/O C/O	.148	16	9" 9"	8	868	\$4,118
052-1622-321	20"	SM SM	.148	16	9" 9"	8	904	\$4,045
052-1622-521	20"	C/O SM	.148	16	9" 9"	8	886	\$4,067
<u>7' 0" WIDE</u>								
052-1832-211	18"	C/O C/O	.138	18	9" 7-1/2"	8	872	\$4,023
052-1832-311	18"	SM SM	.138	18	9" 7-1/2"	8	908	\$3,917
052-1832-511	18"	C/O SM	.138	18	9" 7-1/2"	8	892	\$3,980
052-1832-221	20"	C/O C/O	.148	18	9" 7-1/2"	8	922	\$4,334
052-1832-321	20"	SM SM	.148	18	9" 7-1/2"	8	962	\$4,192
052-1832-521	20"	C/O SM	.148	18	9" 7-1/2"	8	944	\$4,262
052-2012-211	18"	C/O C/O	.138	20	7-1/2" 7-1/2"	8	898	\$4,204
052-2012-311	18"	SM SM	.138	20	7-1/2" 7-1/2"	8	938	\$4,077
052-2012-511	18"	C/O SM	.138	20	7-1/2" 7-1/2"	8	918	\$4,154
052-2012-221	20"	C/O C/O	.148	20	7-1/2" 7-1/2"	8	954	\$4,545
052-2012-321	20"	SM SM	.148	20	7-1/2" 7-1/2"	8	998	\$4,386
052-2012-521	20"	C/O SM	.148	20	7-1/2" 7-1/2"	8	976	\$4,460

<u>MODEL NUMBER</u>	<u>DISC DIAM</u>	<u>TYPE OF DISC</u>		<u>DISC THICK</u>	<u># OF DISC</u>	<u>DISC SPACING</u>		<u># OF BRGS</u>	<u>APX WT</u>	<u>SUGST PRICE</u>
		FRT	REAR			FRT	REAR			
<u>7' 11" WIDE</u>										
052-2022-211	18"	C/O	C/O	.138	20	9"	9"	8	926	\$4,498
052-2022-311	18"	SM	SM	.138	20	9"	9"	8	966	\$4,212
052-2022-511	18"	C/O	SM	.138	20	9"	9"	8	946	\$4,300
052-2022-221	20"	C/O	C/O	.148	20	9"	9"	8	982	\$4,683
052-2022-321	20"	SM	SM	.148	20	9"	9"	8	1026	\$4,526
052-2022-521	20"	C/O	SM	.148	20	9"	9"	8	1004	\$4,614
<u>8' 2" WIDE</u>										
052-2232-211	18"	C/O	C/O	.138	22	9"	7-1/2"	8	946	\$4,496
052-2232-311	18"	SM	SM	.138	22	9"	7-1/2"	8	990	\$4,386
052-2232-511	18"	C/O	SM	.138	22	9"	7-1/2"	8	970	\$4,454
052-2232-221	20"	C/O	C/O	.148	22	9"	7-1/2"	8	1008	\$4,894
052-2232-321	20"	SM	SM	.148	22	9"	7-1/2"	8	1057	\$4,723
052-2232-521	20"	C/O	SM	.148	22	9"	7-1/2"	8	1035	\$4,809
052-2412-211	18"	C/O	C/O	.138	24	7-1/2"	7-1/2"	8	966	\$4,699
052-2412-311	18"	SM	SM	.138	24	7-1/2"	7-1/2"	8	1014	\$4,549
052-2412-511	18"	C/O	SM	.138	24	7-1/2"	7-1/2"	8	990	\$4,618
052-2412-221	20"	C/O	C/O	.148	24	7-1/2"	7-1/2"	8	1033	\$5,106
052-2412-321	20"	SM	SM	.148	24	7-1/2"	7-1/2"	8	1086	\$4,859
052-2412-521	20"	C/O	SM	.148	24	7-1/2"	7-1/2"	8	1060	\$5,023

EXTRA EQUIPMENT

SCRAPERS	WIDTH	SPACING	APPROX. WEIGHT	SUGST PRICE
9-052-916220	6' 6"	9"	122#	\$469
9-052-918320	7' 0"	9" F 7 1/2" R	131#	\$526
9-052-920120	7' 0"	7 1/2"	140#	\$551
9-052-920220	7' 11"	9"	147#	\$608
9-052-922320	8' 2"	9" F 7 1/2" R	157#	\$646
9-052-924120	8' 2"	7 1/2"	166#	\$688

COVER DISCS	DESCRIPTION	APPROX. WEIGHT	SUGST PRICE
9-052-700016	Cover Discs w/o Scraper w/ 16" Disc	34#	\$231
9-052-709016	Cover Discs w/ Scraper w/ 16" Disc	43#	\$269

OPTIONAL EQUIPMENT

TO SPECIFY CAT. II IN LIEU OF CAT I, CHANGE THE 10TH DIGIT FROM 1 TO 2.

NO CHARGE

ATHENS 55 LIFT TYPE DISK HARROW

SPECIFICATIONS:

Cutting Width 6' 6" to 9' 4"
 Disc spacing 7 1/2", 9" or
 9" Front & 7 1/2" Rear
 20" or 22" Discs – Cutout or Smooth
 Heavy Duty Scrapers (Extra Equip.)
 Category I or II Hitch
 Relube Ball Bearings

STANDARD EQUIPMENT:

Category II Hitch
 1 1/8" Cold Rolled Square Axles
 w/ Gang Wrench
 Tapered Outside Rear Disc Gangs
 Factory Assembled Gangs
 Adjustable Angle of Cut
 Flangette Bearing Hangers
 Relube Ball Bearings



<u>MODEL NUMBER</u>	<u>DISC DIAM</u>	<u>TYPE OF DISC</u>		<u>DISC THCK</u>	<u># OF DISC</u>	<u>DISC SPACING</u>		<u># OF BRGS</u>	<u>APX WT</u>	<u>SUGST PRICE</u>
		FRNT	REAR			FRNT	REAR			
<u>6' 6" WIDE</u>										
055-1622-222	20"	C.O.	C.O.	.138	16	9"	9"	8	1006	\$4,769
055-1622-642	22"	C.O.	C.O.	.177	16	9"	9"	8	1054	\$5,056
055-1622-322	20"	SM.	SM.	.138	16	9"	9"	8	1024	\$4,678
055-1622-742	22"	SM.	SM.	.177	16	9"	9"	8	1072	\$4,979
055-1622-522	20"	C.O.	SM.	.138	16	9"	9"	8	1014	\$4,713
055-1622-842	22"	C.O.	SM.	.177	16	9"	9"	8	1063	\$5,000
<u>7' 0" WIDE</u>										
055-1832-222	20"	C.O.	C.O.	.138	18	9"	7-1/2"	8	1039	\$4,955
055-1832-642	22"	C.O.	C.O.	.177	18	9"	7-1/2"	8	1096	\$5,287
055-1832-322	20"	SM.	SM.	.138	18	9"	7-1/2"	8	1058	\$4,839
055-1832-742	22"	SM.	SM.	.177	18	9"	7-1/2"	8	1117	\$5,136
055-1832-522	20"	C.O.	SM.	.138	18	9"	7-1/2"	8	1049	\$4,909
055-1832-842	22"	C.O.	SM.	.177	18	9"	7-1/2"	8	1108	\$5,210
055-2012-222	20"	C.O.	C.O.	.138	20	7-1/2"	7-1/2"	8	1072	\$5,147
055-2012-642	22"	C.O.	C.O.	.177	20	7-1/2"	7-1/2"	8	1138	\$5,514
055-2012-322	20"	SM.	SM.	.138	20	7-1/2"	7-1/2"	8	1092	\$5,015
055-2012-742	22"	SM.	SM.	.177	20	7-1/2"	7-1/2"	8	1161	\$5,342
055-2012-522	20"	C.O.	SM.	.138	20	7-1/2"	7-1/2"	8	1081	\$5,096
055-2012-842	22"	C.O.	SM.	.177	20	7-1/2"	7-1/2"	8	1149	\$5,423

<u>MODEL NUMBER</u>	<u>DISC DIAM</u>	<u>TYPE OF DISC</u>		<u>DISC THCK</u>	<u># OF DISC</u>	<u>DISC SPACING</u>		<u># OF BRGS</u>	<u>APX WT</u>	<u>SUGST PRICE</u>
		<u>FRNT</u>	<u>REAR</u>			<u>FRNT</u>	<u>REAR</u>			
<u>7' 11" WIDE</u>										
055-2022-222	20"	C.O.	C.O.	.138	20	9"	9"	8	1125	\$5,460
055-2022-642	22"	C.O.	C.O.	.177	20	9"	9"	8	1192	\$5,660
055-2022-322	20"	SM.	SM.	.138	20	9"	9"	8	1146	\$5,156
055-2022-742	22"	SM.	SM.	.177	20	9"	9"	8	1215	\$5,493
055-2022-522	20"	C.O.	SM.	.138	20	9"	9"	8	1135	\$5,250
055-2022-842	22"	C.O.	SM.	.177	20	9"	9"	8	1203	\$5,587
<u>8' 2" WIDE</u>										
055-2232-222	20"	C.O.	C.O.	.138	22	9"	7-1/2"	8	1155	\$5,460
055-2232-642	22"	C.O.	C.O.	.177	22	9"	7-1/2"	8	1232	\$5,887
055-2232-322	20"	SM.	SM.	.138	22	9"	7-1/2"	8	1179	\$5,342
055-2232-742	22"	SM.	SM.	.177	22	9"	7-1/2"	8	1257	\$5,702
055-2232-522	20"	C.O.	SM.	.138	22	9"	7-1/2"	8	1168	\$5,416
055-2232-842	22"	C.O.	SM.	.177	22	9"	7-1/2"	8	1245	\$5,795
055-2412-222	20"	C.O.	C.O.	.138	24	7-1/2"	7-1/2"	8	1185	\$5,675
055-2412-642	22"	C.O.	C.O.	.177	24	7-1/2"	7-1/2"	8	1271	\$6,114
055-2412-322	20"	SM.	SM.	.138	24	7-1/2"	7-1/2"	8	1211	\$5,519
055-2412-742	22"	SM.	SM.	.177	24	7-1/2"	7-1/2"	8	1299	\$5,847
055-2412-522	20"	C.O.	SM.	.138	24	7-1/2"	7-1/2"	8	1198	\$5,592
055-2412-842	22"	C.O.	SM.	.177	24	7-1/2"	7-1/2"	8	1285	\$6,023
<u>9' 4" WIDE</u>										
055-2422-222	20"	C.O.	C.O.	.138	24	9"	9"	8	1249	\$5,643
055-2422-642	22"	C.O.	C.O.	.177	24	9"	9"	8	1335	\$6,092
055-2422-322	20"	SM.	SM.	.138	24	9"	9"	8	1275	\$5,487
055-2422-742	22"	SM.	SM.	.177	24	9"	9"	8	1363	\$5,715
055-2422-522	20"	C.O.	SM.	.138	24	9"	9"	8	1262	\$5,580
055-2422-842	22"	C.O.	SM.	.177	24	9"	9"	8	1349	\$5,988
055-2632-222	20"	C.O.	C.O.	.138	26	9"	7-1/2"	8	1289	\$5,847
055-2632-642	22"	C.O.	C.O.	.177	26	9"	7-1/2"	8	1385	\$6,320
055-2632-322	20"	SM.	SM.	.138	26	9"	7-1/2"	8	1317	\$5,665
055-2632-742	22"	SM.	SM.	.177	26	9"	7-1/2"	8	1415	\$6,095
055-2632-522	20"	C.O.	SM.	.138	26	9"	7-1/2"	8	1304	\$5,754
055-2632-842	22"	C.O.	SM.	.177	26	9"	7-1/2"	8	1401	\$6,207
055-2812-222	20"	C.O.	C.O.	.138	28	7-1/2"	7-1/2"	8	1301	\$6,028
055-2812-642	22"	C.O.	C.O.	.177	28	7-1/2"	7-1/2"	8	1406	\$6,551
055-2812-322	20"	SM.	SM.	.138	28	7-1/2"	7-1/2"	8	1331	\$5,847
055-2812-742	22"	SM.	SM.	.177	28	7-1/2"	7-1/2"	8	1439	\$6,312
055-2812-522	20"	C.O.	SM.	.138	28	7-1/2"	7-1/2"	8	1316	\$5,948
055-2812-842	22"	C.O.	SM.	.177	28	7-1/2"	7-1/2"	8	1422	\$6,440

<u>EXTRA EQUIPMENT</u>		<u>WIDTH</u>	<u>SPACING</u>	<u>APX WT</u>	<u>SUGST PRICE</u>
9-055-916220	SCRAPERS	6' 6"	9"	122#	\$577
9-055-918320	SCRAPERS	7' 0"	9"F 7-1/2"R	131#	\$644
9-055-920120	SCRAPERS	7' 0"	7-1/2"	140#	\$674
9-055-920220	SCRAPERS	7' 11"	9"	147#	\$744
9-055-922320	SCRAPERS	8' 2"	9"F 7-1/2"R	157#	\$786
9-055-924120	SCRAPERS	8' 2"	7-1/2"	166#	\$842
9-055-924220	SCRAPERS	9' 4"	9"	175#	\$842
9-055-926320	SCRAPERS	9' 4"	9"F 7-1/2"R	184#	\$877
9-055-928120	SCRAPERS	9' 4"	7-1/2"	193#	\$930

<u>EXTRA EQUIPMENT</u>		<u>APX WT</u>	<u>SUGST PRICE</u>
9-055-700016	COVER DISC W/O SCRAPER W/ 16" DISC	34#	\$246
9-055-709016	COVER DISC W/ SCRAPERS W/ 16" DISC	43#	\$287
9-055-800000	BALK BUSTER	38#	\$246

OPTIONAL EQUIPMENT:

TO SPECIFY CAT. #1 IN LIEU OF CAT.#II, CHANGE
10TH DIGIT FROM 2 TO 1

NO CHARGE

ATHENS 65 LIFT-TYPE TANDEM DISK HARROW

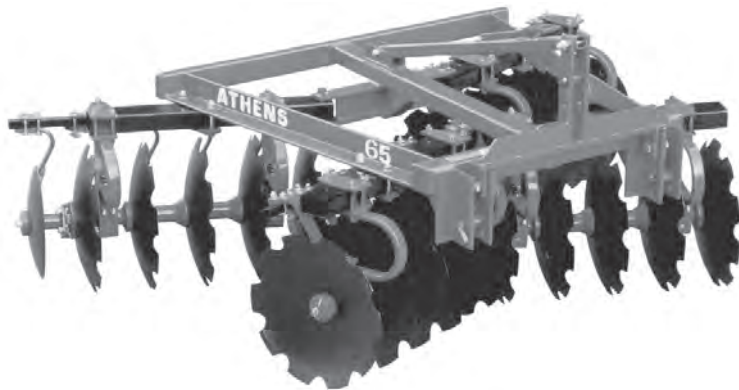

SPECIFICATIONS:

Cutting Width 8', 8' 4", & 9' 6"
 Spacing 9", or 9" Frt & 7 1/2" Rear
 Disc Diameter - 22" or 24" C/O or SM
 Rigid or Spring Bearing Hangers
 Cat. II Free Link/Quick Coupler
 Relube Ball Bearings
 1 1/4" Cold Rolled Square Axle
 with Gang Wrench

<u>MODEL NUMBER</u>	<u>DISC DIAM</u>	<u>TYPE OF DISC</u>		<u>DISC THCK</u>	<u># OF DISC</u>	<u>DISC SPACING</u>		<u># OF BRGS</u>	<u>APX WT</u>	<u>SUGST PRICE</u>
		FRNT	REAR			FRNT	REAR			
<u>8' 0" WIDE</u>										
065-2027-650	22"	C.O.	C.O.	.197	20	9"	9"	8	1710	\$7,781
065-2027-660	24"	C.O.	C.O.	.197	20	9"	9"	8	1770	\$8,220
065-2027-750	22"	SM.	SM.	.197	20	9"	9"	8	1730	\$7,740
065-2027-760	24"	SM.	SM.	.197	20	9"	9"	8	1790	\$8,122
065-2027-850	22"	C.O.	SM.	.197	20	9"	9"	8	1720	\$7,761
065-2027-860	24"	C.O.	SM.	.197	20	9"	9"	8	1780	\$8,170
<u>8' 4" WIDE</u>										
065-2237-650	22"	C.O.	C.O.	.197	22	9"	7-1/2"	8	1762	\$8,184
065-2237-750	22"	SM.	SM.	.197	22	9"	7-1/2"	8	1784	\$8,132
065-2237-850	22"	C.O.	SM.	.197	22	9"	7-1/2"	8	1774	\$8,152
<u>9' 6" WIDE</u>										
065-2427-650	22"	C.O.	C.O.	.197	24	9"	9"	8	1872	\$8,519
065-2427-660	24"	C.O.	C.O.	.197	24	9"	9"	8	1944	\$9,036
065-2427-750	22"	SM.	SM.	.197	24	9"	9"	8	1896	\$8,463
065-2427-760	24"	SM.	SM.	.197	24	9"	9"	8	1968	\$8,924
065-2427-850	22"	C.O.	SM.	.197	24	9"	9"	8	1884	\$8,489
065-2427-860	24"	C.O.	SM.	.197	24	9"	9"	8	1956	\$8,981
065-2637-650	22"	C.O.	C.O.	.197	26	9"	7-1/2"	8	1914	\$8,641
065-2637-750	22"	SM.	SM.	.197	26	9"	7-1/2"	8	1940	\$8,836
065-2637-850	22"	C.O.	SM.	.197	26	9"	7-1/2"	8	1954	\$8,864

OPTIONAL EQUIPMENT

For Spring Bearing Hangers:
 Change the 7th Digit from 7 to 6 and Add 15#
 and \$75.00 per Bearing Weights and Prices.

(CONT'D)

EXTRA EQUIPMENT

SCRAPERS

		<u>SPACING</u>	<u>APX WT</u>	<u>SUGST PRICE</u>
9-065-920270	Scrapers for 8' 0" Units	9"	226	\$852
*9-065-920260		9"	244	\$915
9-065-922370	Scrapers for 8' 4" Units	9"F 7-1/2"R	241	\$906
*9-065-922360		9"F 7-1/2"R	259	\$974
9-065-924270	Scrapers for 9' 6" Units	9"	265	\$1,000
*9-065-924260		9"	283	\$1,065
9-065-926370	Scrapers for 9' 6" Units	9"F 7-1/2"R	280	\$1,054
*9-065-926360		9"F 7-1/2"R	298	\$1,120

*For Units with Spring Bearing Hangers

COVER DISC

9-065-700018	Cover Disc Assembly with 18" Disc w/o Scraper		40	\$303
9-065-709018	Cover Disc Assembly with 18" Disc w/ Scraper		56	\$351
9-065-800000	Balk Buster		23	\$226

ATHENS 66 LIFT TYPE DISK HARROW



SPECIFICATIONS:

Cutting Width 10' 6" to 15' 3"
 Disc Spacing 7 1/2", 9" or
 9" Front & 7 1/2" Rear
 Disc Diameter – 20" or 22" C/O or SM
 Heavy Duty Scrapers (Extra
 Equipment)
 Category II or III Free Link
 or Quick Coupler Hitch

STANDARD EQUIPMENT:

1 1/8" Cold Rolled Square Axle
 Relube Ball Bearings
 Flanette Bearing Hangers
 Adjustable Angle of Cut 16° to 21°
 Tapered Outside Rear Disk Gangs

<u>MODEL NUMBER</u>	<u>DISC DIAM</u>	<u>TYPE OF DISC</u>		<u>DISC THCK</u>	<u># OF DISC</u>	<u>DISC SPACING</u>		<u># OF BRGS</u>	<u>APX WT</u>	<u>SUGST PRICE</u>
		<u>FRNT</u>	<u>REAR</u>			<u>FRNT</u>	<u>REAR</u>			
<u>10' 6" WIDE</u>										
066-3032-222	20"	C.O.	C.O.	.138	30	9"	7-1/2"	8	1924	\$8,531
066-3032-642	22"	C.O.	C.O.	.177	30	9"	7-1/2"	8	2039	\$9,044
066-3032-322	20"	SM.	SM.	.138	30	9"	7-1/2"	8	1957	\$8,681
066-3032-742	22"	SM.	SM.	.177	30	9"	7-1/2"	8	2074	\$8,760
066-3032-522	20"	C.O.	SM.	.138	30	9"	7-1/2"	8	1941	\$8,610
066-3032-842	22"	C.O.	SM.	.177	30	9"	7-1/2"	8	2057	\$9,122
066-3212-222	20"	C.O.	C.O.	.138	32	7-1/2"	7-1/2"	8	1947	\$8,635
066-3212-642	22"	C.O.	C.O.	.177	32	7-1/2"	7-1/2"	8	2071	\$9,185
066-3212-322	20"	SM.	SM.	.138	32	7-1/2"	7-1/2"	8	1982	\$8,794
066-3212-742	22"	SM.	SM.	.177	32	7-1/2"	7-1/2"	8	2109	\$9,354
066-3212-522	20"	C.O.	SM.	.138	32	7-1/2"	7-1/2"	8	1964	\$8,709
066-3212-842	22"	C.O.	SM.	.177	32	7-1/2"	7-1/2"	8	2090	\$9,265
<u>10' 9" WIDE</u>										
066-2822-222	20"	C.O.	C.O.	.138	28	9"	9"	8	1901	\$8,430
066-2822-642	22"	C.O.	C.O.	.177	28	9"	9"	8	2006	\$8,897
066-2822-322	20"	SM.	SM.	.138	28	9"	9"	8	1933	\$8,575
066-2822-742	22"	SM.	SM.	.177	28	9"	9"	8	2039	\$9,044
066-2822-522	20"	C.O.	SM.	.138	28	9"	9"	8	1916	\$8,500
066-2822-842	22"	C.O.	SM.	.177	28	9"	9"	8	2022	\$8,965

<u>MODEL NUMBER</u>	<u>DISC DIAM</u>	<u>TYPE OF DISC</u>		<u>DISC THCK</u>	<u># OF DISC</u>	<u>DISC SPACING</u>		<u># OF BRGS</u>	<u>APX WT</u>	<u>SUGST PRICE</u>
		<u>FRNT</u>	<u>REAR</u>			<u>FRNT</u>	<u>REAR</u>			
<u>12' 2" WIDE</u>										
066-3222-221	20"	C.O.	C.O.	.138	32	9"	9"	12	2044	\$8,864
066-3222-641	22"	C.O.	C.O.	.177	32	9"	9"	12	2180	\$9,620
066-3222-321	20"	SM.	SM.	.138	32	9"	9"	12	2064	\$8,604
066-3222-741	22"	SM.	SM.	.177	32	9"	9"	12	2216	\$9,289
066-3222-521	20"	C.O.	SM.	.138	32	9"	9"	12	2058	\$8,730
066-3222-841	22"	C.O.	SM.	.177	32	9"	9"	12	2197	\$9,450
<u>12' 11" WIDE</u>										
066-3632-221	20"	C.O.	C.O.	.138	36	9"	7-1/2"	12	2103	\$9,067
066-3632-641	22"	C.O.	C.O.	.177	36	9"	7-1/2"	12	2257	\$9,743
066-3632-321	20"	SM.	SM.	.138	36	9"	7-1/2"	12	2234	\$8,798
066-3632-741	22"	SM.	SM.	.177	36	9"	7-1/2"	12	2298	\$9,473
066-3632-521	20"	C.O.	SM.	.138	36	9"	7-1/2"	12	2219	\$8,850
066-3632-841	22"	C.O.	SM.	.177	36	9"	7-1/2"	12	2279	\$9,656
066-4012-221	20"	C.O.	C.O.	.138	40	7-1/2"	7-1/2"	12	2161	\$9,258
066-4012-641	22"	C.O.	C.O.	.177	40	7-1/2"	7-1/2"	12	2334	\$10,065
066-4012-321	20"	SM.	SM.	.138	40	7-1/2"	7-1/2"	12	2195	\$8,953
066-4012-741	22"	SM.	SM.	.177	40	7-1/2"	7-1/2"	12	2406	\$9,663
066-4012-521	20"	C.O.	SM.	.138	40	7-1/2"	7-1/2"	12	2177	\$9,146
066-4012-841	22"	C.O.	SM.	.177	40	7-1/2"	7-1/2"	12	2356	\$9,890
<u>13' 6" WIDE</u>										
066-3622-221	20"	C.O.	C.O.	.138	36	9"	9"	12	2194	\$9,685
066-3622-641	22"	C.O.	C.O.	.177	36	9"	9"	12	2298	\$10,455
066-3622-321	20"	SM.	SM.	.138	36	9"	9"	12	2207	\$9,429
066-3622-741	22"	SM.	SM.	.177	36	9"	9"	12	2328	\$10,114
066-3622-521	20"	C.O.	SM.	.138	36	9"	9"	12	2200	\$9,562
066-3622-841	22"	C.O.	SM.	.177	36	9"	9"	12	2313	\$10,289
<u>14' 1" WIDE</u>										
066-4032-221	20"	C.O.	C.O.	.138	40	9"	7-1/2"	12	2269	\$9,890
066-4032-641	22"	C.O.	C.O.	.177	40	9"	7-1/2"	12	2387	\$10,714
066-4032-321	20"	SM.	SM.	.138	40	9"	7-1/2"	12	2283	\$9,587
066-4032-741	22"	SM.	SM.	.177	40	9"	7-1/2"	12	2421	\$10,333
066-4032-521	20"	C.O.	SM.	.138	40	9"	7-1/2"	12	2276	\$9,746
066-4032-841	22"	C.O.	SM.	.177	40	9"	7-1/2"	12	2405	\$10,525
066-4412-221	20"	C.O.	C.O.	.138	44	7-1/2"	7-1/2"	12	2342	\$10,024
066-4412-641	22"	C.O.	C.O.	.177	44	7-1/2"	7-1/2"	12	2476	\$10,910
066-4412-321	20"	SM.	SM.	.138	44	7-1/2"	7-1/2"	12	2358	\$9,704
066-4412-741	22"	SM.	SM.	.177	44	7-1/2"	7-1/2"	12	2513	\$10,991
066-4412-521	20"	C.O.	SM.	.138	44	7-1/2"	7-1/2"	12	2349	\$9,864
066-4412-841	22"	C.O.	SM.	.177	44	7-1/2"	7-1/2"	12	2495	\$10,733

<u>MODEL NUMBER</u>	<u>DISC DIAM</u>	<u>TYPE OF DISC</u>		<u>DISC THCK</u>	<u># OF DISC</u>	<u>DISC SPACING</u>		<u># OF BRGS</u>	<u>APX WT</u>	<u>SUGST PRICE</u>
		FRNT	REAR			FRNT	REAR			
<u>15' 0" WIDE</u>										
066-4022-221	20"	C.O.	C.O.	.138	40	9"	9"	16	2326	\$10,188
066-4022-641	22"	C.O.	C.O.	.177	40	9"	9"	16	2444	\$11,111
066-4022-321	20"	SM.	SM.	.138	40	9"	9"	16	2340	\$10,064
066-4022-741	22"	SM.	SM.	.177	40	9"	9"	16	2478	\$10,647
066-4022-521	20"	C.O.	SM.	.138	40	9"	9"	16	2282	\$10,128
066-4022-841	22"	C.O.	SM.	.177	40	9"	9"	16	2462	\$10,876

15' 3" WIDE

066-4432-221	20"	C.O.	C.O.	.138	44	9"	7-1/2"	16	2388	\$10,560
066-4432-641	22"	C.O.	C.O.	.177	44	9"	7-1/2"	16	2522	\$11,616
066-4432-321	20"	SM.	SM.	.138	44	9"	7-1/2"	16	2404	\$10,434
066-4432-741	22"	SM.	SM.	.177	44	9"	7-1/2"	16	2559	\$11,093
066-4432-521	20"	C.O.	SM.	.138	44	9"	7-1/2"	16	2397	\$10,501
066-4432-841	22"	C.O.	SM.	.177	44	9"	7-1/2"	16	2542	\$11,358
066-4812-221	20"	C.O.	C.O.	.138	48	7-1/2"	7-1/2"	16	2448	\$10,941
066-4812-641	22"	C.O.	C.O.	.177	48	7-1/2"	7-1/2"	16	2598	\$12,118
066-4812-321	20"	SM.	SM.	.138	48	7-1/2"	7-1/2"	16	2466	\$10,812
066-4812-741	22"	SM.	SM.	.177	48	7-1/2"	7-1/2"	16	2638	\$11,538
066-4812-521	20"	C.O.	SM.	.138	48	7-1/2"	7-1/2"	16	2457	\$10,876
066-4812-841	22"	C.O.	SM.	.177	48	7-1/2"	7-1/2"	16	2618	\$11,830

<u>EXTRA EQUIPMENT</u>	<u>WIDTH</u>	<u>SPACING</u>	<u>APX WT</u>	<u>SUGST PRICE</u>	
9-066-928220	SCRAPERS	10' 9"	9"	336	\$958
9-066-930320	SCRAPERS	10' 6"	9"F 7-1/2"R	360	\$1,027
9-066-932120	SCRAPERS	10' 6"	7-1/2"	384	\$1,096
9-066-932220	SCRAPERS	12' 2"	9"	390	\$1,139
9-066-936320	SCRAPERS	12' 11"	9"F 7-1/2"R	422	\$1,275
9-066-940120	SCRAPERS	12' 11"	7-1/2"	453	\$1,420
9-066-936220	SCRAPERS	13' 6"	9"	428	\$1,290
9-066-940320	SCRAPERS	14' 1"	9"F 7-1/2"R	459	\$1,427
9-066-944120	SCRAPERS	14' 1"	7-1/2"	493	\$1,576
9-066-940220	SCRAPERS	15' 0"	9"	463	\$1,474
9-066-944320	SCRAPERS	15' 3"	9"F 7-1/2"R	489	\$1,606
9-066-948120	SCRAPERS	15' 3"	7-1/2"	531	\$1,746
9-066-700016	COVER DISC W/O SCRAPERS			34	\$191
9-066-709016	COVER DISC W/ SCRAPERS			43	\$258
9-066-800000	BALK BUSTER			23	\$218

ATHENS 62 WHEEL TANDEM DISK HARROW

SPECIFICATIONS:

Cutting Width – 7' 11" to 12' 11"

Spacing – 7 ½", 9" or

9" Front & 7 ½" Rear

Disc Diameter – 20" or 22" C/O or SM

Heavy Duty Scrapers (Extra Equip)

STANDARD EQUIPMENT

Heavy – Duty Tongue with Jack

15", 5 Lug Wheels w/ Hubs

Tapered Outside Rear Disc Gangs

1 ½" Cold Rolled Square Axles

w/ Gang Wrench

Adjustable Angle of Cut

Flangette Bearing Hangers

Relube Ball Bearings

Lifting Hydraulics



<u>MODEL NUMBER</u>	<u>DISC DIAM</u>	<u>TYPE OF DISC</u> FRNT REAR	<u>DISC THCK</u>	<u># OF DISC</u>	<u>DISC SPACING</u> FRNT REAR		<u># OF BRGS</u>	<u>APX WT</u>	<u>SUGST PRICE</u>
<u>7' 11" WIDE</u>									
062-2022-221	20"	C.O. C.O.	.138	20	9"	9"	8	1584	\$8,727
062-2022-641	22"	C.O. C.O.	.177	20	9"	9"	8	1643	\$9,186
062-2022-321	20"	SM. SM.	.138	20	9"	9"	8	1591	\$8,563
062-2022-741	22"	SM. SM.	.177	20	9"	9"	8	1646	\$8,972
062-2022-521	20"	C.O. SM.	.138	20	9"	9"	8	1588	\$8,663
062-2022-841	22"	C.O. SM.	.177	20	9"	9"	8	1645	\$9,081
<u>8' 2" WIDE</u>									
062-2232-221	20"	C.O. C.O.	.138	22	9"	7-1/2"	8	1613	\$8,954
062-2232-641	22"	C.O. C.O.	.177	22	9"	7-1/2"	8	1680	\$9,455
062-2232-321	20"	SM. SM.	.138	22	9"	7-1/2"	8	1620	\$8,780
062-2232-741	22"	SM. SM.	.177	22	9"	7-1/2"	8	1682	\$9,224
062-2232-521	20"	C.O. SM.	.138	22	9"	7-1/2"	8	1617	\$8,882
062-2232-841	22"	C.O. SM.	.177	22	9"	7-1/2"	8	1682	\$9,333
062-2412-221	20"	C.O. C.O.	.138	24	7-1/2"	7-1/2"	8	1647	\$9,186
062-2412-641	22"	C.O. C.O.	.177	24	7-1/2"	7-1/2"	8	1741	\$9,732
062-2412-321	20"	SM. SM.	.138	24	7-1/2"	7-1/2"	8	1666	\$8,985
062-2412-741	22"	SM. SM.	.177	24	7-1/2"	7-1/2"	8	1768	\$9,467
062-2412-521	20"	C.O. SM.	.138	24	7-1/2"	7-1/2"	8	1655	\$9,180
062-2412-841	22"	C.O. SM.	.177	24	7-1/2"	7-1/2"	8	1754	\$9,774

MODEL NUMBER	DISC DIAM	TYPE OF DISC		DISC THCK	# OF DISC	DISC SPACING		# OF BRGS	APX WT	SUGST PRICE
		FRNT	REAR			FRNT	REAR			
<u>9' 4" WIDE</u>										
062-2422-221	20"	C.O.	C.O.	.138	24	9"	9"	8	1695	\$9,151
062-2422-641	22"	C.O.	C.O.	.177	24	9"	9"	8	1789	\$9,669
062-2422-321	20"	SM.	SM.	.138	24	9"	9"	8	1714	\$8,954
062-2422-741	22"	SM.	SM.	.177	24	9"	9"	8	1816	\$9,449
062-2422-521	20"	C.O.	SM.	.138	24	9"	9"	8	1703	\$9,035
062-2422-841	22"	C.O.	SM.	.177	24	9"	9"	8	1802	\$9,579
062-2632-221	20"	C.O.	C.O.	.138	26	9"	7-1/2"	8	1710	\$9,383
062-2632-641	22"	C.O.	C.O.	.177	26	9"	7-1/2"	8	1824	\$9,982
062-2632-321	20"	SM.	SM.	.138	26	9"	7-1/2"	8	1741	\$9,163
062-2632-741	22"	SM.	SM.	.177	26	9"	7-1/2"	8	1853	\$9,704
062-2632-521	20"	C.O.	SM.	.138	26	9"	7-1/2"	8	1730	\$9,279
062-2632-841	22"	C.O.	SM.	.177	26	9"	7-1/2"	8	1839	\$9,832
062-2812-221	20"	C.O.	C.O.	.138	28	7-1/2"	7-1/2"	8	1744	\$9,610
062-2812-641	22"	C.O.	C.O.	.177	28	7-1/2"	7-1/2"	8	1858	\$10,255
062-2812-321	20"	SM.	SM.	.138	28	7-1/2"	7-1/2"	8	1768	\$9,371
062-2812-741	22"	SM.	SM.	.177	28	7-1/2"	7-1/2"	8	1800	\$9,947
062-2812-521	20"	C.O.	SM.	.138	28	7-1/2"	7-1/2"	8	1755	\$9,509
062-2812-841	22"	C.O.	SM.	.177	28	7-1/2"	7-1/2"	8	1874	\$10,108
<u>10' 6" WIDE</u>										
062-3032-221	20"	C.O.	C.O.	.138	30	9"	7-1/2"	8	1899	\$10,316
062-3032-641	22"	C.O.	C.O.	.177	30	9"	7-1/2"	8	2023	\$11,011
062-3032-321	20"	SM.	SM.	.138	30	9"	7-1/2"	8	1924	\$10,057
062-3032-741	22"	SM.	SM.	.177	30	9"	7-1/2"	8	2057	\$10,752
062-3032-521	20"	C.O.	SM.	.138	30	9"	7-1/2"	8	1911	\$10,190
062-3032-841	22"	C.O.	SM.	.177	30	9"	7-1/2"	8	2041	\$10,839
062-3212-221	20"	C.O.	C.O.	.138	32	7-1/2"	7-1/2"	8	1917	\$10,524
062-3212-641	22"	C.O.	C.O.	.177	32	7-1/2"	7-1/2"	8	2051	\$11,530
062-3212-321	20"	SM.	SM.	.138	32	7-1/2"	7-1/2"	8	1945	\$10,412
062-3212-741	22"	SM.	SM.	.177	32	7-1/2"	7-1/2"	8	2088	\$10,919
062-3212-521	20"	C.O.	SM.	.138	32	7-1/2"	7-1/2"	8	1930	\$10,406
062-3212-841	22"	C.O.	SM.	.177	32	7-1/2"	7-1/2"	8	2069	\$11,103
<u>10' 9" WIDE</u>										
062-2822-221	20"	C.O.	C.O.	.138	28	9"	9"	8	1880	\$10,087
062-2822-641	22"	C.O.	C.O.	.177	28	9"	9"	8	1995	\$10,793
062-2822-321	20"	SM.	SM.	.138	28	9"	9"	8	1905	\$9,860
062-2822-741	22"	SM.	SM.	.177	28	9"	9"	8	2026	\$10,429
062-2822-521	20"	C.O.	SM.	.138	28	9"	9"	8	1891	\$9,982
062-2822-841	22"	C.O.	SM.	.177	28	9"	9"	8	2010	\$10,592

<u>MODEL NUMBER</u>	<u>DISC DIAM</u>	<u>TYPE OF DISC</u>		<u>DISC THCK</u>	<u># OF DISC</u>	<u>DISC SPACING</u>		<u># OF BRGS</u>	<u>APX WT</u>	<u>SUGST PRICE</u>
		FRNT	REAR			FRNT	REAR			
<u>12' 2" WIDE</u>										
062-3222-221	20"	C.O.	C.O.	.138	32	9"	9"	12	2166	\$11,590
062-3222-641	22"	C.O.	C.O.	.177	32	9"	9"	12	2300	\$12,347
062-3222-321	20"	SM.	SM.	.138	32	9"	9"	12	2184	\$11,339
062-3222-741	22"	SM.	SM.	.177	32	9"	9"	12	2336	\$11,998
062-3222-521	20"	C.O.	SM.	.138	32	9"	9"	12	2178	\$11,475
062-3222-841	22"	C.O.	SM.	.177	32	9"	9"	12	2317	\$12,180

12' 11" WIDE

062-3632-221	20"	C.O.	C.O.	.138	36	9"	7-1/2"	12	2223	\$12,030
062-3632-641	22"	C.O.	C.O.	.177	36	9"	7-1/2"	12	2377	\$12,864
062-3632-321	20"	SM.	SM.	.138	36	9"	7-1/2"	12	2354	\$11,726
062-3632-741	22"	SM.	SM.	.177	36	9"	7-1/2"	12	2418	\$12,475
062-3632-521	20"	C.O.	SM.	.138	36	9"	7-1/2"	12	2339	\$11,874
062-3632-841	22"	C.O.	SM.	.177	36	9"	7-1/2"	12	2399	\$12,667
062-4012-221	20"	C.O.	C.O.	.138	40	7-1/2"	7-1/2"	12	2281	\$12,475
062-4012-641	22"	C.O.	C.O.	.177	40	7-1/2"	7-1/2"	12	2454	\$13,398
062-4012-321	20"	SM.	SM.	.138	40	7-1/2"	7-1/2"	12	2315	\$12,124
062-4012-741	22"	SM.	SM.	.177	40	7-1/2"	7-1/2"	12	2526	\$12,964
062-4012-521	20"	C.O.	SM.	.138	40	7-1/2"	7-1/2"	12	2297	\$12,320
062-4012-841	22"	C.O.	SM.	.177	40	7-1/2"	7-1/2"	12	2476	\$13,186

<u>EXTRA EQUIPMENT</u>		<u>WIDTH</u>	<u>SPACING</u>	<u>APX WT</u>	<u>SUGST PRICE</u>
9-062-920220	SCRAPERS	7' 11"	9"	177#	\$749
9-062-922320	SCRAPERS	8' 2"	9" F 7-1/2"R	196#	\$794
9-062-924120	SCRAPERS	8' 2"	7-1/2"	208#	\$852
9-062-924220	SCRAPERS	9' 4"	9"	214#	\$852
9-062-926320	SCRAPERS	9' 4"	9" F 7-1/2"R	231#	\$880
9-062-928120	SCRAPERS	9' 4"	7-1/2"	250#	\$942
9-062-932120	SCRAPERS	10' 6"	7-1/2"	296#	\$1,033
9-062-928220	SCRAPERS	10' 9"	9"	263#	\$936
9-062-930320	SCRAPERS	10' 6"	9" F 7-1/2"R	278#	\$997
9-062-932220	SCRAPERS	12' 2"	9"	305#	\$1,092
9-062-936320	SCRAPERS	12' 11"	9" F 7-1/2"R	337#	\$1,189
9-062-940120	SCRAPERS	12' 11"	7-1/2"	367#	\$1,285

EXTRA EQUIPMENT (CONT'D)

		APX	SUGST
		<u>WT</u>	<u>PRICE</u>
9-062-800000	BALK BUSTER	38#	\$268
9-062-700016	COVER DISC W/O SCRAPERS W/ 16" DISC	34#	\$242
9-062-709016	COVER DISC W/ SCRAPERS W/ 16" DISC	43#	\$286

RECOMMENDED TIRE SIZE: 9.5L x 15

CAUTION: TIRES ARE RATED AT 20 MPH MAXIMUM

***PRICE DOES NOT INCLUDE TIRES**

ATHENS 76R RIGID DOUBLE OFFSET HARROW

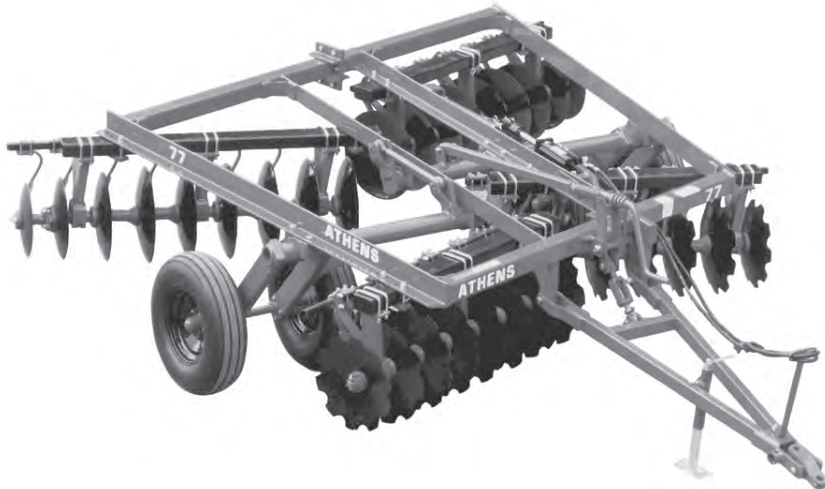

SPECIFICATIONS:

Cutting Width – 8' 10" to 15' 1"
 22" or 24" Discs, Cutout or Smooth
 Spacing 9", 7 ½", or 9"F & 7 ½"R
 Trunnion Mounted Housing with
 Relube Quadriseal Ball Bearings
 Spring or Rigid Bearing Hangers
 1 ¼" Sq. Cold Rolled Gang Axles

STANDARD EQUIPMENT:

Self-Leveling Frame
 "A" Frame Tongue w/Jack
 Heavy-Duty, Tubular Mtd Scrapers
 Cover Discs w/ Scrapers
 Split Wheel Carriages
 Lifting Hydraulics w/ Mech. Transport
 Adjustable Angle of Cut
 15" x 6" – 5 Lug Wheels w/ Hubs
 Tapered Front & Rear Disc Gangs

<u>MODEL NUMBER</u>	<u>DISC DIAM</u>	<u>TYPE OF DISC</u> FRNT REAR	<u>DISC THCK</u>	<u># OF DISC</u>	<u>DISC SPACING</u> FRNT REAR	<u># OF BRGS</u>	<u>APX WT</u>	<u>SUGST PRICE</u>
<u>8' 10" WIDE W/ RIGID BEARING HANGERS</u>								
76R-2427-637	22"	C.O. C.O.	.197	24	9" 9"	8	2694	\$14,564
76R-2427-667	24"	C.O. C.O.	.197	24	9" 9"	8	2840	\$14,775
76R-2427-737	22"	SM. SM.	.197	24	9" 9"	8	2714	\$14,137
76R-2427-767	24"	SM. SM.	.197	24	9" 9"	8	2870	\$14,469
76R-2427-837	22"	C.O. SM.	.197	24	9" 9"	8	2704	\$15,149
76R-2427-867	24"	C.O. SM.	.197	24	9" 9"	8	2853	\$14,627
76R-2637-637	22"	C.O. C.O.	.197	26	9" 7-1/2"	8	2752	\$15,378
76R-2637-737	22"	SM. SM.	.197	26	9" 7-1/2"	8	2783	\$14,979
76R-2637-837	22"	C.O. SM.	.197	26	9" 7-1/2"	8	2767	\$15,175
76R-2817-637	22"	C.O. C.O.	.197	28	7-1/2" 7-1/2"	8	2809	\$15,749
76R-2817-737	22"	SM. SM.	.197	28	7-1/2" 7-1/2"	8	2843	\$15,317
76R-2817-837	22"	C.O. SM.	.197	28	7-1/2" 7-1/2"	8	2825	\$15,530
<u>W/ SPRING BEARING HANGERS</u>								
76R-2426-657	22"	C.O. C.O.	.197	24	9" 9"	8	2902	\$14,609
76R-2426-757	22"	SM. SM.	.197	24	9" 9"	8	3048	\$14,397
76R-2426-857	22"	C.O. SM.	.197	24	9" 9"	8	2922	\$14,486
76R-2636-657	22"	C.O. C.O.	.197	26	9" 7-1/2"	8	2968	\$14,927
76R-2636-757	22"	SM. SM.	.197	26	9" 7-1/2"	8	2999	\$14,770
76R-2636-857	22"	C.O. SM.	.197	26	9" 7-1/2"	8	2983	\$14,847

<u>MODEL NUMBER</u>	<u>DISC DIAM</u>	<u>TYPE OF DISC</u>		<u>DISC THCK</u>	<u># OF DISC</u>	<u>DISC SPACING</u>		<u># OF BRGS</u>	<u>APX WT</u>	<u>SUGST PRICE</u>
		<u>FRNT</u>	<u>REAR</u>			<u>FRNT</u>	<u>REAR</u>			
<u>10' 3" WIDE</u>		<u>W/ RIGID BEARING HANGERS</u>								
76R-2827-637	22"	C.O.	C.O.	.197	28	9"	9"	8	2885	\$15,789
76R-2827-667	24"	C.O.	C.O.	.197	28	9"	9"	8	3056	\$16,034
76R-2827-737	22"	SM.	SM.	.197	28	9"	9"	8	2911	\$15,354
76R-2827-767	24"	SM.	SM.	.197	28	9"	9"	8	3092	\$15,708
76R-2827-837	22"	C.O.	SM.	.197	28	9"	9"	8	2898	\$15,572
76R-2827-867	24"	C.O.	SM.	.197	28	9"	9"	8	3073	\$15,875
76R-3037-637	22"	C.O.	C.O.	.197	30	9"	7-1/2"	8	2943	\$16,161
76R-3037-737	22"	SM.	SM.	.197	30	9"	7-1/2"	8	2979	\$15,701
76R-3037-837	22"	C.O.	SM.	.197	30	9"	7-1/2"	8	2961	\$15,917
76R-3217-637	22"	C.O.	C.O.	.197	32	7-1/2"	7-1/2"	8	3012	\$16,173
76R-3217-737	22"	SM.	SM.	.197	32	7-1/2"	7-1/2"	8	3051	\$15,901
76R-3217-837	22"	C.O.	SM.	.197	32	7-1/2"	7-1/2"	8	3031	\$15,939
		<u>W/ SPRING BEARING HANGERS</u>								
76R-2826-657	22"	C.O.	C.O.	.197	28	9"	9"	8	3105	\$15,725
76R-2826-757	22"	SM.	SM.	.197	28	9"	9"	8	3131	\$15,542
76R-2826-857	22"	C.O.	SM.	.197	28	9"	9"	8	3118	\$15,637
76R-3036-657	22"	C.O.	C.O.	.197	30	9"	7-1/2"	8	3175	\$16,034
76R-3036-757	22"	SM.	SM.	.197	30	9"	7-1/2"	8	3211	\$15,565
76R-3036-857	22"	C.O.	SM.	.197	30	9"	7-1/2"	8	3352	\$15,806
76R-3216-657	22"	C.O.	C.O.	.197	32	7-1/2"	7-1/2"	8	3252	\$16,346
76R-3216-757	22"	SM.	SM.	.197	32	7-1/2"	7-1/2"	8	3291	\$15,879
76R-3216-857	22"	C.O.	SM.	.197	32	7-1/2"	7-1/2"	8	3352	\$16,110
<u>11' 1" WIDE</u>		<u>W/ RIGID BEARING HANGERS</u>								
76R-3437-637	22"	C.O.	C.O.	.197	34	9"	7-1/2"	12	3205	\$18,142
76R-3437-737	22"	SM.	SM.	.197	34	9"	7-1/2"	12	3247	\$17,606
76R-3437-837	22"	C.O.	SM.	.197	34	9"	7-1/2"	12	3227	\$17,868
76R-3617-637	22"	C.O.	C.O.	.197	36	7-1/2"	7-1/2"	12	3251	\$18,570
76R-3617-737	22"	SM.	SM.	.197	36	7-1/2"	7-1/2"	12	3295	\$18,003
76R-3617-837	22"	C.O.	SM.	.197	36	7-1/2"	7-1/2"	12	3273	\$18,296
		<u>W/ SPRING BEARING HANGERS</u>								
76R-3436-657	22"	C.O.	C.O.	.197	34	9"	7-1/2"	12	3521	\$18,272
76R-3436-757	22"	SM.	SM.	.197	34	9"	7-1/2"	12	3563	\$18,056
76R-3436-857	22"	C.O.	SM.	.197	34	9"	7-1/2"	12	3543	\$18,159
76R-3616-657	22"	C.O.	C.O.	.197	36	7-1/2"	7-1/2"	12	3575	\$18,683
76R-3616-757	22"	SM.	SM.	.197	36	7-1/2"	7-1/2"	12	3619	\$18,436
76R-3616-857	22"	C.O.	SM.	.197	36	7-1/2"	7-1/2"	12	3597	\$18,564

<u>MODEL NUMBER</u>	<u>DISC DIAM</u>	<u>TYPE OF DISC</u>		<u>DISC THCK</u>	<u># OF DISC</u>	<u>DISC SPACING</u>		<u># OF BRGS</u>	<u>APX WT</u>	<u>SUGST PRICE</u>
		<u>FRNT</u>	<u>REAR</u>			<u>FRNT</u>	<u>REAR</u>			
<u>11' 8" WIDE</u>		<u>W/ RIGID BEARING HANGERS</u>								
76R-3227-637	22"	C.O.	C.O.	.197	32	9"	9"	12	3191	\$17,853
76R-3227-667	24"	C.O.	C.O.	.197	32	9"	9"	12	3388	\$18,017
76R-3227-737	22"	SM.	SM.	.197	32	9"	9"	12	3231	\$17,369
76R-3227-767	24"	SM.	SM.	.197	32	9"	9"	12	3430	\$17,543
76R-3227-837	22"	C.O.	SM.	.197	32	9"	9"	12	3210	\$17,626
76R-3227-867	24"	C.O.	SM.	.197	32	9"	9"	12	3409	\$17,791
		<u>W/ SPRING BEARING HANGERS</u>								
76R-3226-657	22"	C.O.	C.O.	.197	32	9"	9"	12	3499	\$17,998
76R-3226-757	22"	SM.	SM.	.197	32	9"	9"	12	3528	\$17,808
76R-3226-857	22"	C.O.	SM.	.197	32	9"	9"	12	3513	\$17,909
<u>13' 1" WIDE</u>		<u>W/ RIGID BEARING HANGERS</u>								
76R-3627-637	22"	C.O.	C.O.	.197	36	9"	9"	12	3387	\$18,652
76R-3627-667	24"	C.O.	C.O.	.197	36	9"	9"	12	3611	\$18,967
76R-3627-737	22"	SM.	SM.	.197	36	9"	9"	12	3420	\$18,085
76R-3627-767	24"	SM.	SM.	.197	36	9"	9"	12	3659	\$18,536
76R-3627-837	22"	C.O.	SM.	.197	36	9"	9"	12	3388	\$18,342
76R-3627-867	24"	C.O.	SM.	.197	36	9"	9"	12	3634	\$18,754
		<u>W/ SPRING BEARING HANGERS</u>								
76R-3626-657	22"	C.O.	C.O.	.197	36	9"	9"	12	3707	\$18,831
76R-3626-757	22"	SM.	SM.	.197	36	9"	9"	12	3740	\$18,520
76R-3626-857	22"	C.O.	SM.	.197	36	9"	9"	12	3708	\$18,683
<u>13' 5" WIDE</u>		<u>W/ RIGID BEARING HANGERS</u>								
76R-4037-637	22"	C.O.	C.O.	.197	40	9"	7-1/2"	12	3531	\$19,447
76R-4037-737	22"	SM.	SM.	.197	40	9"	7-1/2"	12	3569	\$18,846
76R-4037-837	22"	C.O.	SM.	.197	40	9"	7-1/2"	12	3546	\$19,121
76R-4417-637	22"	C.O.	C.O.	.197	44	7-1/2"	7-1/2"	12	3739	\$20,240
76R-4417-737	22"	SM.	SM.	.197	44	7-1/2"	7-1/2"	12	3792	\$19,579
76R-4417-837	22"	C.O.	SM.	.197	44	7-1/2"	7-1/2"	12	3765	\$19,907
		<u>W/ SPRING BEARING HANGERS</u>								
76R-4036-657	22"	C.O.	C.O.	.197	40	9"	7-1/2"	12	3871	\$19,585
76R-4036-757	22"	SM.	SM.	.197	40	9"	7-1/2"	12	3909	\$19,339
76R-4036-857	22"	C.O.	SM.	.197	40	9"	7-1/2"	12	3886	\$19,454
76R-4416-657	22"	C.O.	C.O.	.197	44	7-1/2"	7-1/2"	12	4009	\$20,343
76R-4416-757	22"	SM.	SM.	.197	44	7-1/2"	7-1/2"	12	4062	\$20,079
76R-4416-857	22"	C.O.	SM.	.197	44	7-1/2"	7-1/2"	12	4035	\$20,209

MODEL NUMBER	DISC DIAM	TYPE OF DISC		DISC THCK	# OF DISC	DISC SPACING		# OF BRGS	APX WT	SUGST PRICE
		FRNT	REAR			FRNT	REAR			
<u>14' 6" WIDE</u> <u>W/ RIGID BEARING HANGERS</u>										
76R-4027-637	22"	C.O.	C.O.	.197	40	9"	9"	12	3657	\$19,586
76R-4027-667	24"	C.O.	C.O.	.197	40	9"	9"	12	3910	\$19,861
76R-4027-737	22"	SM.	SM.	.197	40	9"	9"	12	3694	\$18,876
76R-4027-767	24"	SM.	SM.	.197	40	9"	9"	12	3962	\$19,206
76R-4027-837	22"	C.O.	SM.	.197	40	9"	9"	12	3676	\$19,261
76R-4027-867	24"	C.O.	SM.	.197	40	9"	9"	12	3935	\$19,459

W/ SPRING BEARING HANGERS

76R-4026-657	22"	C.O.	C.O.	.197	40	9"	9"	12	3993	\$19,725
76R-4026-757	22"	SM.	SM.	.197	40	9"	9"	12	4030	\$19,380
76R-4026-857	22"	C.O.	SM.	.197	40	9"	9"	12	4012	\$19,574

15' 1" WIDE W/ RIGID BEARING HANGERS

76R-4437-637	22"	C.O.	C.O.	.197	44	9"	7-1/2"	12	3788	\$20,337
76R-4437-737	22"	SM.	SM.	.197	44	9"	7-1/2"	12	3841	\$19,673
76R-4437-837	22"	C.O.	SM.	.197	44	9"	7-1/2"	12	3816	\$19,985
76R-4817-637	22"	C.O.	C.O.	.197	48	7-1/2"	7-1/2"	12	3908	\$21,000
76R-4817-737	22"	SM.	SM.	.197	48	7-1/2"	7-1/2"	12	3966	\$20,276
76R-4817-837	22"	C.O.	SM.	.197	48	7-1/2"	7-1/2"	12	3937	\$20,645

W/ SPRING BEARING HANGERS

76R-4436-657	22"	C.O.	C.O.	.197	44	9"	7-1/2"	16	4144	\$20,438
76R-4436-757	22"	SM.	SM.	.197	44	9"	7-1/2"	16	4197	\$20,172
76R-4436-857	22"	C.O.	SM.	.197	44	9"	7-1/2"	16	4172	\$20,294
76R-4816-657	22"	C.O.	C.O.	.197	48	7-1/2"	7-1/2"	12	4280	\$21,053
76R-4816-757	22"	SM.	SM.	.197	48	7-1/2"	7-1/2"	12	4338	\$20,774
76R-4816-857	22"	C.O.	SM.	.197	48	7-1/2"	7-1/2"	12	4309	\$20,925

<u>EXTRA EQUIPMENT</u>									APX WT	SUGST PRICE
9-076-605156	DUAL WHEELS FOR 8' 10" TO 13' 5" UNITS (DUAL WHEELS ARE STANDARD ON 14' 6" & 15' 1" UNITS)								90	\$826
106165	AG LIGHT KIT								17	\$500

RECOMMENDED TIRE SIZE: 9.5L x 15
CAUTION: TIRES ARE RATED AT 20 MPH MAXIMUM.
*PRICE DOES NOT INCLUDE TIRES.

ATHENS 77R RIGID DOUBLE OFFSET DISK HARROW

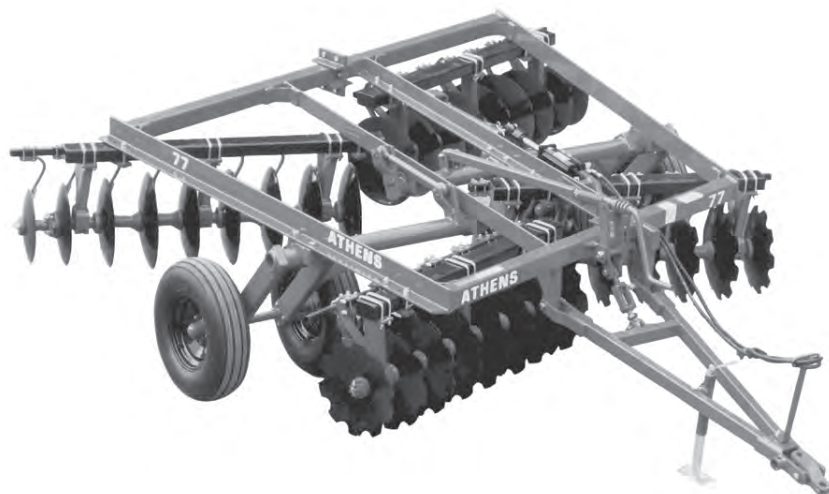

SPECIFICATIONS:

Width – 11' 8" to 15' 9"
 22" or 24" Discs, Cutout or Smooth
 Spacing – 9", 7 1/2", or 9"Frnt & 7 1/2"R
 Trunnion Mounted Housing with
 QUADRASEAL Ball Bearings
 Spring or Rigid Bearing Hangers
 1 1/4" Sq. Cold Rolled Gang Axles

STANDARD EQUIPMENT:

Self-Leveling Frame
 "A" Frame Tongue w/ Jack
 Heavy-duty Tubular Mounted Scrapers
 Cover Discs w/Scrapers
 Split Wheel Carriages
 Lifting Hyd. w/ Mechanical Transport
 Adjustable Angle of Cut
 15" x 6" – 5 Lug Dual Wheels w/ Hubs
 Tapered Front & Rear Gangs

<u>MODEL NUMBER</u>	<u>DISC DIAM</u>	<u>TYPE OF DISC</u>		<u>DISC THCK</u>	<u># OF DISC</u>	<u>DISC SPACING</u>		<u># OF BRGS</u>	<u>APX WT</u>	<u>SUGST PRICE</u>
		<u>FRNT</u>	<u>REAR</u>			<u>FRNT</u>	<u>REAR</u>			
<u>11' 1" WIDE W/ RIGID BEARING HANGERS</u>										
77R-3437-631	22"	C.O.	C.O.	.197	34	9"	7-1/2"	12	3700	\$21,368
77R-3437-731	22"	SM.	SM.	.197	34	9"	7-1/2"	12	3742	\$20,826
77R-3437-831	22"	C.O.	SM.	.197	34	9"	7-1/2"	12	3721	\$21,076
77R-3617-631	22"	C.O.	C.O.	.197	36	7-1/2"	7-1/2"	12	3746	\$21,824
77R-3617-731	22"	SM.	SM.	.197	36	7-1/2"	7-1/2"	12	3789	\$21,242
77R-3617-831	22"	C.O.	SM.	.197	36	7-1/2"	7-1/2"	12	3767	\$21,537
<u>W/ SPRING BEARING HANGERS</u>										
77R-3436-651	22"	C.O.	C.O.	.197	34	9"	7-1/2"	12	4016	\$21,574
77R-3436-751	22"	SM.	SM.	.197	34	9"	7-1/2"	12	4058	\$21,335
77R-3436-851	22"	C.O.	SM.	.197	34	9"	7-1/2"	12	4037	\$21,458
77R-3616-651	22"	C.O.	C.O.	.197	36	7-1/2"	7-1/2"	12	4070	\$22,011
77R-3616-751	22"	SM.	SM.	.197	36	7-1/2"	7-1/2"	12	4113	\$21,761
77R-3616-851	22"	C.O.	SM.	.197	36	7-1/2"	7-1/2"	12	4091	\$21,898
<u>11' 8" WIDE W/ RIGID BEARING HANGERS</u>										
77R-3227-631	22"	C.O.	C.O.	.197	32	9"	9"	12	3701	\$21,047
77R-3227-661	24"	C.O.	C.O.	.197	32	9"	9"	12	3868	\$21,286
77R-3227-731	22"	SM.	SM.	.197	32	9"	9"	12	3740	\$20,556

MODEL NUMBER	DISC DIAM	TYPE OF DISC		DISC THCK	# OF DISC	DISC SPACING		# OF BRGS	APX WT	SUGST PRICE
		FRNT	REAR			FRNT	REAR			
<u>11' 8" WIDE</u>										
<u>W/ RIGID BEARING HANGERS (CONT'D)</u>										
77R-3227-761	24"	SM.	SM.	.197	32	9"	9"	12	3907	\$20,775
77R-3227-831	22"	C.O.	SM.	.197	32	9"	9"	12	3720	\$20,812
77R-3227-861	24"	C.O.	SM.	.197	32	9"	9"	12	3886	\$21,044
<u>W/ SPRING BEARING HANGERS</u>										
77R-3226-651	22"	C.O.	C.O.	.197	32	9"	9"	12	4009	\$20,922
77R-3226-751	22"	SM.	SM.	.197	32	9"	9"	12	4048	\$20,722
77R-3226-851	22"	C.O.	SM.	.197	32	9"	9"	12	4028	\$20,824
<u>13' 1" WIDE</u>										
<u>W/ RIGID BEARING HANGERS</u>										
77R-3627-631	22"	C.O.	C.O.	.197	36	9"	9"	12	3913	\$21,909
77R-3627-661	24"	C.O.	C.O.	.197	36	9"	9"	12	4093	\$22,323
77R-3627-731	22"	SM.	SM.	.197	36	9"	9"	12	3950	\$21,244
77R-3627-761	24"	SM.	SM.	.197	36	9"	9"	12	4146	\$21,849
77R-3627-831	22"	C.O.	SM.	.197	36	9"	9"	12	3934	\$21,584
77R-3627-861	24"	C.O.	SM.	.197	36	9"	9"	12	4123	\$22,093
<u>W/ SPRING BEARING HANGERS</u>										
77R-3626-651	22"	C.O.	C.O.	.197	36	9"	9"	12	4219	\$22,104
77R-3626-751	22"	SM.	SM.	.197	36	9"	9"	12	4260	\$21,767
77R-3626-851	22"	C.O.	SM.	.197	36	9"	9"	12	4240	\$21,939
<u>13' 6" WIDE</u>										
<u>W/ RIGID BEARING HANGERS</u>										
77R-4037-631	22"	C.O.	C.O.	.197	40	9"	7-1/2"	12	4011	\$22,758
77R-4037-731	22"	SM.	SM.	.197	40	9"	7-1/2"	12	4059	\$22,134
77R-4037-831	22"	C.O.	SM.	.197	40	9"	7-1/2"	12	4037	\$22,420
77R-4417-631	22"	C.O.	C.O.	.197	44	7-1/2"	7-1/2"	12	4147	\$23,611
77R-4417-731	22"	SM.	SM.	.197	44	7-1/2"	7-1/2"	12	4200	\$22,931
77R-4417-831	22"	C.O.	SM.	.197	44	7-1/2"	7-1/2"	12	4174	\$23,271
<u>W/ SPRING BEARING HANGERS</u>										
77R-4036-651	22"	C.O.	C.O.	.197	40	9"	7-1/2"	12	4351	\$22,915
77R-4036-751	22"	SM.	SM.	.197	40	9"	7-1/2"	12	4399	\$22,651
77R-4036-851	22"	C.O.	SM.	.197	40	9"	7-1/2"	12	4379	\$22,782
77R-4416-651	22"	C.O.	C.O.	.197	44	7-1/2"	7-1/2"	12	4503	\$23,750
77R-4416-751	22"	SM.	SM.	.197	44	7-1/2"	7-1/2"	12	4556	\$23,455
77R-4416-851	22"	C.O.	SM.	.197	44	7-1/2"	7-1/2"	12	4530	\$23,602
<u>14' 6" WIDE</u>										
<u>W/ RIGID BEARING HANGERS</u>										
77R-4027-631	22"	C.O.	C.O.	.197	40	9"	9"	12	4080	\$22,905
77R-4027-661	24"	C.O.	C.O.	.197	40	9"	9"	12	4290	\$23,448
77R-4027-731	22"	SM.	SM.	.197	40	9"	9"	12	4129	\$22,304

MODEL NUMBER	DISC DIAM	TYPE OF DISC		DISC THCK	# OF DISC	DISC SPACING		# OF BRGS	APX WT	SUGST PRICE
		FRNT	REAR			FRNT	REAR			
<u>14' 6" WIDE</u> <u>W/ RIGID BEARING HANGERS (CONT'D)</u>										
77R-4027-761	24"	SM.	SM.	.197	40	9"	9"	12	4342	\$22,574
77R-4027-831	22"	C.O.	SM.	.197	40	9"	9"	12	4108	\$22,609
77R-4027-861	24"	C.O.	SM.	.197	40	9"	9"	12	4316	\$22,915
<u>W/ SPRING BEARING HANGER</u>										
77R-4026-651	22"	C.O.	C.O.	.197	40	9"	9"	12	4420	\$23,069
77R-4026-751	22"	SM.	SM.	.197	40	9"	9"	12	4469	\$22,915
77R-4026-851	22"	C.O.	SM.	.197	40	9"	9"	12	4448	\$22,945
<u>15' 1" WIDE</u> <u>W/ RIGID BEARING HANGERS</u>										
77R-4437-631	22"	C.O.	C.O.	.197	44	9"	7-1/2"	12	4217	\$24,063
77R-4437-731	22"	SM.	SM.	.197	44	9"	7-1/2"	12	4240	\$23,168
77R-4437-831	22"	C.O.	SM.	.197	44	9"	7-1/2"	12	4216	\$23,504
77R-4817-631	22"	C.O.	C.O.	.197	48	7-1/2"	7-1/2"	12	4327	\$24,563
77R-4817-731	22"	SM.	SM.	.197	48	7-1/2"	7-1/2"	12	4485	\$23,801
77R-4817-831	22"	C.O.	SM.	.197	48	7-1/2"	7-1/2"	12	4356	\$24,191
<u>W/ SPRING BEARING HANGERS</u>										
77R-4436-651	22"	C.O.	C.O.	.197	44	9"	7-1/2"	12	4573	\$23,847
77R-4436-751	22"	SM.	SM.	.197	44	9"	7-1/2"	12	4596	\$23,554
77R-4436-851	22"	C.O.	SM.	.197	44	9"	7-1/2"	12	4572	\$23,704
77R-4816-651	22"	C.O.	C.O.	.197	48	7-1/2"	7-1/2"	12	4699	\$24,659
77R-4816-751	22"	SM.	SM.	.197	48	7-1/2"	7-1/2"	12	4857	\$24,329
77R-4816-851	22"	C.O.	SM.	.197	48	7-1/2"	7-1/2"	12	4728	\$24,506
<u>15' 9" WIDE</u> <u>W/ RIGID BEARING HANGERS</u>										
77R-4427-631	22"	C.O.	C.O.	.197	44	9"	9"	12	4247	\$23,905
77R-4427-661	24"	C.O.	C.O.	.197	44	9"	9"	12	4487	\$24,406
77R-4427-731	22"	SM.	SM.	.197	44	9"	9"	12	4308	\$23,245
77R-4427-761	24"	SM.	SM.	.197	44	9"	9"	12	4538	\$23,499
77R-4427-831	22"	C.O.	SM.	.197	44	9"	9"	12	4282	\$23,585
77R-4427-861	24"	C.O.	SM.	.197	44	9"	9"	12	4509	\$23,851

<u>EXTRA EQUIPMENT</u>									APX WT	SUGST PRICE
106165	AG LIGHT KIT								17#	\$500

RECOMMENDED TIRE SIZE: 9.5L x 15 (4 REQUIRED)
CAUTION: TIRES ARE RATED AT 20 MPH MAXIMUM.
*PRICE DOES NOT INCLUDE TIRES.

ATHENS 93 WHEEL TANDEM DISK HARROW

SPECIFICATIONS:

Cutting Width – 9' 4" to 15' 3"
 Disc Spacing – 7-1/2", 9" or
 9" Frt, 7-1/2" Rear
 22" or 24" Discs- Cutout or Smooth

STANDARD EQUIPMENT:

Reversible Clevis Hitch
 Heavy – Duty Tongue w/ Jack
 1 1/4" Cold Rolled Sq. Axles
 w/ Gang Wrench
 Tapered Outside Rear and
 Front Gangs
 Heavy – Duty Scrapers
 Cover Discs w/ Scrapers
 15", 5 Lug Wheels w/ QUADRASEAL
 Wheel Hubs
 Mechanical Transport
 Adjustable Angle of Cut
 Relube QUADRASEAL Ball Bearings
 Lifting Hydraulics



MODEL NUMBER	DISC DIAM	TYPE OF DISC		DISC THCK	# OF DISC	DISC SPACING		# OF BRGS	APX WT	SUGST PRICE
		FRNT	REAR			FRNT	REAR			
<u>9' 4" WIDE</u>										
093-2427-651	22"	C.O.	C.O.	.197	24	9"	9"	8	2805	\$15,028
093-2427-661	24"	C.O.	C.O.	.197	24	9"	9"	8	2867	\$16,183
093-2427-751	22"	SM.	SM.	.197	24	9"	9"	8	2835	\$15,356
093-2427-761	24"	SM.	SM.	.197	24	9"	9"	8	2898	\$16,021
093-2427-851	22"	C.O.	SM.	.197	24	9"	9"	8	2820	\$14,872
093-2427-861	24"	C.O.	SM.	.197	24	9"	9"	8	2883	\$16,076
093-2637-651	22"	C.O.	C.O.	.197	26	9"	7-1/2"	8	2867	\$15,457
093-2637-751	22"	SM.	SM.	.197	26	9"	7-1/2"	8	2898	\$14,829
093-2637-851	22"	C.O.	SM.	.197	26	9"	7-1/2"	8	2883	\$15,015
093-2817-651	22"	C.O.	C.O.	.197	28	7-1/2"	7-1/2"	8	2932	\$16,535
093-2817-751	22"	SM.	SM.	.197	28	7-1/2"	7-1/2"	8	2966	\$16,139
093-2817-851	22"	C.O.	SM.	.197	28	7-1/2"	7-1/2"	8	2949	\$16,343
<u>10' 6" WIDE</u>										
093-3037-651	22"	C.O.	C.O.	.197	30	9"	7-1/2"	8	3073	\$16,489
093-3037-751	22"	SM.	SM.	.197	30	9"	7-1/2"	8	3109	\$16,073
093-3037-851	22"	C.O.	SM.	.197	30	9"	7-1/2"	8	3092	\$16,274
093-3217-651	22"	C.O.	C.O.	.197	32	7-1/2"	7-1/2"	8	3136	\$16,839
093-3217-751	22"	SM.	SM.	.197	32	7-1/2"	7-1/2"	8	3174	\$16,465
093-3217-851	22"	C.O.	SM.	.197	32	7-1/2"	7-1/2"	8	3155	\$16,693

MODEL NUMBER	DISC DIAM	TYPE OF DISC		DISC THCK	# OF DISC	DISC SPACING		# OF BRGS	APX WT	SUGST PRICE
		FRNT	REAR			FRNT	REAR			
<u>10' 6" WIDE (CONT'D)</u>										
093-2827-651	22"	C.O.	C.O.	.197	28	9"	9"	8	3011	\$16,077
093-2827-661	24"	C.O.	C.O.	.197	28	9"	9"	8	3087	\$17,381
093-2827-751	22"	SM.	SM.	.197	28	9"	9"	8	3045	\$15,692
093-2827-761	24"	SM.	SM.	.197	28	9"	9"	8	3123	\$16,688
093-2827-851	22"	C.O.	SM.	.197	28	9"	9"	8	3028	\$15,885
093-2827-861	24"	C.O.	SM.	.197	28	9"	9"	8	3105	\$17,250
<u>12' 2" WIDE</u>										
093-3227-651	22"	C.O.	C.O.	.197	32	9"	9"	12	3363	\$18,387
093-3227-661	24"	C.O.	C.O.	.197	32	9"	9"	12	3452	\$19,903
093-3227-751	22"	SM.	SM.	.197	32	9"	9"	12	3401	\$17,754
093-3227-761	24"	SM.	SM.	.197	32	9"	9"	12	3493	\$19,628
093-3227-851	22"	C.O.	SM.	.197	32	9"	9"	12	3382	\$18,176
093-3227-861	24"	C.O.	SM.	.197	32	9"	9"	12	3473	\$19,737
<u>12' 11" WIDE</u>										
093-3637-651	22"	C.O.	C.O.	.197	36	9"	7-1/2"	12	3453	\$19,256
093-3637-751	22"	SM.	SM.	.197	36	9"	7-1/2"	12	3496	\$18,747
093-3637-851	22"	C.O.	SM.	.197	36	9"	7-1/2"	12	3477	\$18,982
093-4017-651	22"	C.O.	C.O.	.197	40	7-1/2"	7-1/2"	12	3641	\$20,112
093-4017-751	22"	SM.	SM.	.197	40	7-1/2"	7-1/2"	12	3689	\$19,544
093-4017-851	22"	C.O.	SM.	.197	40	7-1/2"	7-1/2"	12	3665	\$19,838
<u>13' 6" WIDE</u>										
093-3627-651	22"	C.O.	C.O.	.197	36	9"	9"	12	3656	\$20,291
093-3627-661	24"	C.O.	C.O.	.197	36	9"	9"	12	3759	\$21,954
093-3627-751	22"	SM.	SM.	.197	36	9"	9"	12	3699	\$19,786
093-3627-761	24"	SM.	SM.	.197	36	9"	9"	12	3805	\$21,621
093-3627-851	22"	C.O.	SM.	.197	36	9"	9"	12	3677	\$20,047
093-3627-861	24"	C.O.	SM.	.197	36	9"	9"	12	3783	\$21,763
<u>14' 1" WIDE</u>										
093-4037-651	22"	C.O.	C.O.	.197	40	9"	7-1/2"	12	3792	\$21,148
093-4037-751	22"	SM.	SM.	.197	40	9"	7-1/2"	12	3840	\$20,588
093-4037-851	22"	C.O.	SM.	.197	40	9"	7-1/2"	12	3818	\$20,839
093-4417-651	22"	C.O.	C.O.	.197	44	7-1/2"	7-1/2"	12	3930	\$22,013
093-4417-751	22"	SM.	SM.	.197	44	7-1/2"	7-1/2"	12	3984	\$21,384
093-4417-851	22"	C.O.	SM.	.197	44	7-1/2"	7-1/2"	12	3958	\$21,704

MODEL NUMBER	DISC DIAM	TYPE OF DISC		DISC THCK	# OF DISC	DISC SPACING		# OF BRGS	APX WT	SUGST PRICE
		FRNT	REAR			FRNT	REAR			
<u>15' 0" WIDE</u>										
093-4027-651	22"	C.O.	C.O.	.197	40	9"	9"	16	4582	\$22,557
093-4027-661	24"	C.O.	C.O.	.197	40	9"	9"	16	4700	\$24,456
093-4027-751	22"	SM.	SM.	.197	40	9"	9"	16	4630	\$21,982
093-4027-761	24"	SM.	SM.	.197	40	9"	9"	16	4751	\$24,065
093-4027-851	22"	C.O.	SM.	.197	40	9"	9"	16	4606	\$22,277
093-4027-861	24"	C.O.	SM.	.197	40	9"	9"	16	4727	\$24,239
<u>15' 3" WIDE</u>										
093-4437-651	22"	C.O.	C.O.	.197	44	9"	7-1/2"	16	4721	\$23,403
093-4437-751	22"	SM.	SM.	.197	44	9"	7-1/2"	16	4341	\$22,782
093-4437-851	22"	C.O.	SM.	.197	44	9"	7-1/2"	16	4750	\$23,073
093-4817-651	22"	C.O.	C.O.	.197	48	7-1/2"	7-1/2"	16	4853	\$24,251
093-4817-751	22"	SM.	SM.	.197	48	7-1/2"	7-1/2"	16	4911	\$23,560
093-4817-851	22"	C.O.	SM.	.197	48	7-1/2"	7-1/2"	16	4882	\$23,914

EXTRA EQUIPMENT

9-093-605156	DUAL WHEELS COMPLETE (DUAL WHEELS STANDARD ON 13' 6" TO 15' 3" MODELS)								98	\$879
9-093-800000	BALK BUSTER (CENTER TOOTH)								34	\$297

SPECIAL ORDERING INTRUCTIONS:

FOR SPRING BEARING HANGERS:

***NOTE: Spring Bearing Hangers Require 9" Spacing**

Change 7th digit to 8 and 10th digit to S

With 22" Blades: Add 48# and \$260.00 per bearing.

With 24" Blades: Add 48# and \$260.00 per bearing.

RECOMMENDED TIRE SIZE: 9.5L X 15

CAUTION: TIRES ARE RATED AT 20 MPH MAXIMUM.

***NOTE: PRICE DOES NOT INCLUDE TIRES.**

ATHENS 153 TANDEM DISK HARROW

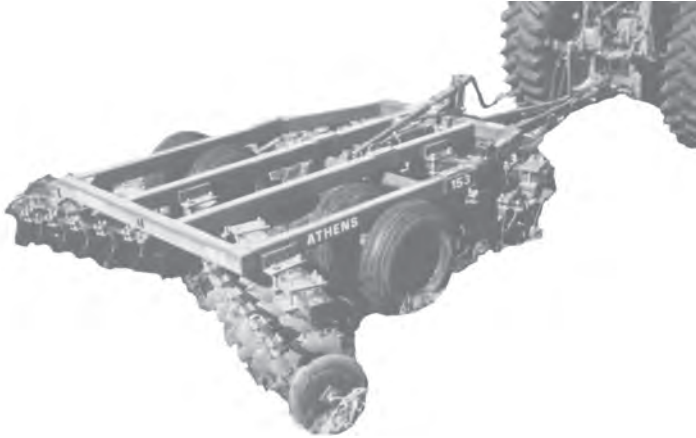

SPECIFICATIONS:

Cutting Width 9' 6", 11', and 12' 6"
24" C/O or SM Discs on 9 1/2" Spacing
Rigid or Spring Bearing Hangers
1 1/2" Cold Rolled Square Axles

STANDARD EQUIPMENT:

Tapered Double Roller Bearings
Dual Wheels
Hydraulic Lifting
Heavy Duty Scrapers (Tubular Mount)
Cover Discs with Scrapers
Tapered Discs on Front & Rear Gangs
Self-Leveling
Reversible Balanced Clevis

<u>MODEL NUMBER</u>	<u>DISC DIAM</u>	<u>TYPE OF DISC</u>		<u>DISC THCK</u>	<u># OF DISC</u>	<u>DISC SPACING</u>		<u># OF BRGS</u>	<u>APX WT</u>	<u>SUGST PRICE</u>
		<u>FRNT</u>	<u>REAR</u>			<u>FRNT</u>	<u>REAR</u>			
<u>9' 6" WIDE</u>										
<u>RIGID BEARING HANGERS</u>										
153-2445-651	24"	C.O.	C.O.	.256	24	9-1/2"		8	4133	\$21,176
153-2445-751	24"	SM.	SM.	.256	24	9-1/2"		8	4174	\$21,013
153-2445-851	24"	C.O.	SM.	.256	24	9-1/2"		8	4153	\$21,097
<u>SPRING BEARING HANGERS</u>										
153-2444-651	24"	C.O.	C.O.	.256	24	9-1/2"		8	4417	\$21,834
153-2444-751	24"	SM.	SM.	.256	24	9-1/2"		8	4458	\$21,668
153-2444-851	24"	C.O.	SM.	.256	24	9-1/2"		8	4437	\$21,750
<u>11' 0" WIDE</u>										
<u>RIGID BEARING HANGERS</u>										
153-2845-651	24"	C.O.	C.O.	.256	28	9-1/2"		10	4604	\$22,939
153-2845-751	24"	SM.	SM.	.256	28	9-1/2"		10	4651	\$22,733
153-2845-851	24"	C.O.	SM.	.256	28	9-1/2"		10	4628	\$22,836
<u>SPRING BEARING HANGERS</u>										
153-2844-651	24"	C.O.	C.O.	.256	28	9-1/2"		10	4861	\$24,719
153-2844-751	24"	SM.	SM.	.256	28	9-1/2"		10	4908	\$24,506
153-2844-851	24"	C.O.	SM.	.256	28	9-1/2"		10	4885	\$24,610
<u>12' 6" WIDE</u>										
<u>RIGID BEARING HANGERS</u>										
153-3245-651	24"	C.O.	C.O.	.256	32	9-1/2"		12	5050	\$24,939
153-3245-751	24"	SM.	SM.	.256	32	9-1/2"		12	5104	\$24,633
153-3245-851	24"	C.O.	SM.	.256	32	9-1/2"		12	5078	\$24,787
<u>SPRING BEARING HANGERS</u>										
153-3244-651	24"	C.O.	C.O.	.256	32	9-1/2"		12	5476	\$27,158
153-3244-751	24"	SM.	SM.	.256	32	9-1/2"		12	5530	\$26,836
153-3244-851	24"	C.O.	SM.	.256	32	9-1/2"		12	5504	\$26,997

RECOMMENDED TIRE SIZE : 9.5L X 15 (4 REQUIRED)
CAUTION: TIRES ARE RATED AT 20 MPH MAXIMUM.
***NOTE: PRICE DOES NOT INCLUDE TIRES.**

**ATHENS 116 FLEX WING
DOUBLE OFFSET DISK HARROW**

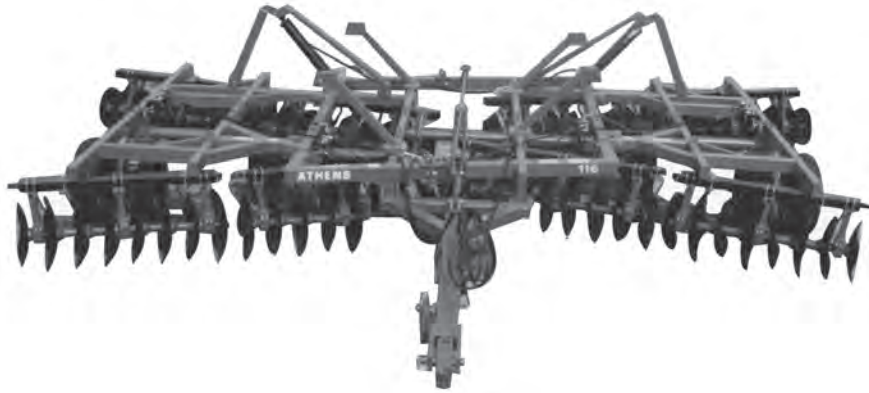

SPECIFICATIONS:

16' 8" to 28' 8" Widths
 Flex Wing, Double Offset
 Truss-Braced, Tubular Frames
 Self – Leveling Frame
 Two Pairs Slave Lifting Cylinders
 Six or Eight Lifting Wheels
 Angle Adjustable (15° – 19°)
 Transport Height Maximum 168"
 Transport Width Maximum 136" or 156"
 22" or 24" Discs, 1.25" Sq. Axle
 Disc Spacing – 9", 7-1/2" or
 9" Front, 7-1/2" Rear

STANDARD EQUIPMENT:

Trunnion Mounted, Rigid Bearing
 Hangers w/QUADRASEAL Ball
 Bearings
 Lifting and Folding Hydraulics
 "A" Frame Tongue w/ Jack
 Reversible Tongue Clevis
 Cover Discs with Discs & Scrapers
 Heavy Duty Disc Scrapers
 Double Tapered Discs on Rear
 Single Tapered Discs on Front
 15" x 8" 6-Lug Wheels w/ Hubs
 Dual Wheels on Center Section

<u>MODEL NUMBER</u>	<u>DISC DIAM</u>	<u>TYPE OF DISC</u>		<u>DISC THCK</u>	<u># OF DISC</u>	<u>DISC SPACING</u>		<u># OF BRGS</u>	<u>APX WT</u>	<u>SUGST PRICE</u>
		<u>FRNT</u>	<u>REAR</u>			<u>FRNT</u>	<u>REAR</u>			
<u>16' 8" WIDE</u>										
116-4427-651	22"	C.O.	C.O.	.197	44	9"	9"	16	7233	\$37,114
116-4427-661	24"	C.O.	C.O.	.197	44	9"	9"	16	7319	\$37,819
116-4427-751	22"	SM.	SM.	.197	44	9"	9"	16	7277	\$36,610
116-4427-761	24"	SM.	SM.	.197	44	9"	9"	16	7374	\$37,132
116-4427-851	22"	C.O.	SM.	.197	44	9"	9"	16	7255	\$36,869
116-4427-861	24"	C.O.	SM.	.197	44	9"	9"	16	7347	\$37,487
116-4837-651	22"	C.O.	C.O.	.197	48	9"	7-1/2"	16	7350	\$37,834
116-4837-751	22"	SM.	SM.	.197	48	9"	7-1/2"	16	7398	\$37,283
116-4837-851	22"	C.O.	SM.	.197	48	9"	7-1/2"	16	7376	\$37,543
116-5217-651	22"	C.O.	C.O.	.197	52	7-1/2"	7-1/2"	16	7496	\$38,572
116-5217-751	22"	SM.	SM.	.197	52	7-1/2"	7-1/2"	16	7548	\$37,968
116-5217-851	22"	C.O.	SM.	.197	52	7-1/2"	7-1/2"	16	7522	\$38,283

MODEL NUMBER	DISC DIAM	TYPE OF DISC		DISC THCK	# OF DISC	DISC SPACING		# OF BRGS	APX WT	SUGST PRICE
		FRNT	REAR			FRNT	REAR			
<u>19' 6" WIDE</u>										
116-5227-651	22"	C.O.	C.O.	.197	52	9"	9"	16	7635	\$38,834
116-5227-661	24"	C.O.	C.O.	.197	52	9"	9"	16	7735	\$39,667
116-5227-751	22"	SM.	SM.	.197	52	9"	9"	16	7687	\$38,255
116-5227-761	24"	SM.	SM.	.197	52	9"	9"	16	7800	\$38,934
116-5227-851	22"	C.O.	SM.	.197	52	9"	9"	16	7661	\$38,575
116-5227-861	24"	C.O.	SM.	.197	52	9"	9"	16	7768	\$39,267
116-5637-651	22"	C.O.	C.O.	.197	56	9"	7-1/2"	16	7734	\$39,633
116-5637-751	22"	SM.	SM.	.197	56	9"	7-1/2"	16	7790	\$38,956
116-5637-851	22"	C.O.	SM.	.197	56	9"	7-1/2"	16	7764	\$39,267
116-6017-651	22"	C.O.	C.O.	.197	60	7-1/2"	7-1/2"	16	7885	\$40,322
116-6017-751	22"	SM.	SM.	.197	60	7-1/2"	7-1/2"	16	7945	\$39,625
116-6017-851	22"	C.O.	SM.	.197	60	7-1/2"	7-1/2"	16	7915	\$39,993
<u>22' 0" WIDE</u>										
116-5627-651	22"	C.O.	C.O.	.197	56	9"	9"	16	7756	\$39,599
116-5627-661	24"	C.O.	C.O.	.197	56	9"	9"	16	8002	\$40,482
116-5627-751	22"	SM.	SM.	.197	56	9"	9"	16	7872	\$39,240
116-5627-761	24"	SM.	SM.	.197	56	9"	9"	16	8059	\$39,947
116-5627-851	22"	C.O.	SM.	.197	56	9"	9"	16	7830	\$39,425
116-5627-861	24"	C.O.	SM.	.197	56	9"	9"	16	8031	\$40,495
116-6237-651	22"	C.O.	C.O.	.197	62	9"	7-1/2"	16	7890	\$40,203
116-6237-751	22"	SM.	SM.	.197	62	9"	7-1/2"	16	7982	\$39,902
116-6237-851	22"	C.O.	SM.	.197	62	9"	7-1/2"	16	7940	\$39,978
116-6817-651	22"	C.O.	C.O.	.197	68	7-1/2"	7-1/2"	18	8237	\$43,189
116-6817-751	22"	SM.	SM.	.197	68	7-1/2"	7-1/2"	18	8338	\$42,516
116-6817-851	22"	C.O.	SM.	.197	68	7-1/2"	7-1/2"	18	8284	\$42,961
<u>23' 4" WIDE</u>										
116-6027-652	22"	C.O.	C.O.	.197	60	9"	9"	20	8567	\$42,759
116-6027-662	24"	C.O.	C.O.	.197	60	9"	9"	20	8451	\$43,701
116-6027-752	22"	SM.	SM.	.197	60	9"	9"	20	8627	\$42,057
116-6027-762	24"	SM.	SM.	.197	60	9"	9"	20	8526	\$42,743
116-6027-852	22"	C.O.	SM.	.197	60	9"	9"	20	8597	\$42,420
116-6027-862	24"	C.O.	SM.	.197	60	9"	9"	20	8477	\$43,237
116-6637-652	22"	C.O.	C.O.	.197	66	9"	7-1/2"	20	8723	\$43,857
116-6637-752	22"	SM.	SM.	.197	66	9"	7-1/2"	20	8822	\$43,078
116-6637-852	22"	C.O.	SM.	.197	66	9"	7-1/2"	20	8789	\$43,444
116-7217-652	22"	C.O.	C.O.	.197	72	7-1/2"	7-1/2"	20	8898	\$45,012
116-7217-752	22"	SM.	SM.	.197	72	7-1/2"	7-1/2"	20	8970	\$44,158
116-7217-852	22"	C.O.	SM.	.197	72	7-1/2"	7-1/2"	20	8934	\$44,599

<u>MODEL NUMBER</u>	<u>DISC DIAM</u>	<u>TYPE OF DISC</u>		<u>DISC THCK</u>	<u># OF DISC</u>	<u>DISC SPACING</u>		<u># OF BRGS</u>	<u>APX WT</u>	<u>SUGST PRICE</u>
		FRNT	REAR			FRNT	REAR			
<u>26' 0" WIDE</u>										
116-7027-653	22"	C.O.	C.O.	.197	68	9"	9"	24	9699	\$48,243
116-7027-663	24"	C.O.	C.O.	.197	68	9"	9"	24	9826	\$49,241
116-7027-753	22"	SM.	SM.	.197	68	9"	9"	24	9767	\$47,433
116-7027-763	24"	SM.	SM.	.197	68	9"	9"	24	9912	\$48,183
116-7027-853	22"	C.O.	SM.	.197	68	9"	9"	24	9733	\$47,834
116-7027-863	24"	C.O.	SM.	.197	68	9"	9"	24	9870	\$48,725
<u>28' 8" WIDE</u>										
116-7827-653	22"	C.O.	C.O.	.197	76	9"	9"	24	10135	\$51,168
116-7827-663	24"	C.O.	C.O.	.197	76	9"	9"	24	10305	\$51,921
116-7827-753	22"	SM.	SM.	.197	76	9"	9"	24	10250	\$50,668
116-7827-763	24"	SM.	SM.	.197	76	9"	9"	24	10420	\$51,424
116-7827-853	22"	C.O.	SM.	.197	76	9"	9"	24	10200	\$50,919
116-7827-863	24"	C.O.	SM.	.197	76	9"	9"	24	10310	\$51,669

<u>EXTRA EQUIPMENT</u>		<u>APX WT</u>	<u>SUGST PRICE</u>
9-116-606158	Dual Wheels for Narrow Wing Units (16' 8" & 19' 6") w/ Two 15 x 6, Six Lug Wheels Dual Wheels Standard on 22' 0" and up	112#	\$1,060
106122	AG LIGHT KIT	18#	\$500

Tapered Double Roller Bearings available at \$125.00 per bearing

RECOMMENDED TIRE SIZE: 11L x 15
CAUTION: TIRES ARE RATED AT 20 MPH MAXIMUM.
***PRICE DOES NOT INCLUDE TIRES.**

ATHENS 119 FLEX WING DOUBLE OFFSET DISK HARROW

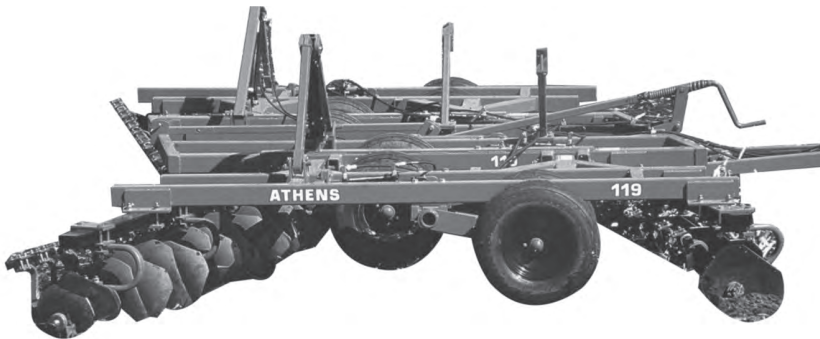

SPECIFICATIONS:

Cutting Width – 19' 6" to 29' 0"
 Flex Wing, Double Offset
 Truss-Braced, Tubular Frames
 Two Pairs Slave Lifting Cylinders
 Six or Eight Wheels
 Angle Adjustable (15° & 19°)
 Transport Height Maximum, 168"
 Transport Width Maximum, 136" or 156"
 22" Discs on 1 ¼" Square Axle
 Disc Spacing – 9"
 "A" Frame Braced Tongue

STANDARD EQUIPMENT:

QUADRASEAL Tapered
 Double Roller Bearings
 Spring Bearing Hangers
 Lifting and Folding Hydraulics
 Tongue with Heavy-Duty Jack
 Reversible, Balanced Clevis
 Cover-Discs w/ Scrapers
 Heavy-Duty Disc Scrapers
 Double Tapered Discs on Rear
 Single Tapered Discs on Front
 15" x 8" 6-Lug Wheels w/ Hubs
 Dual Wheels on Center Section

<u>MODEL NUMBER</u>	<u>DISC DIAM</u>	<u>TYPE OF DISC</u>		<u>DISC THCK</u>	<u># OF DISC</u>	<u>DISC SPACING</u>	<u># OF BRGS</u>	<u>APX WT</u>	<u>SUGST PRICE</u>
		FRNT	REAR						
<u>19' 6" WIDE</u>									
119-5424-651	22"	C.O.	C.O.	.197	52	9"	18	8070	\$44,909
119-5424-751	22"	SM.	SM.	.197	52	9"	18	8122	\$44,250
119-5424-851	22"	C.O.	SM.	.197	52	9"	18	8096	\$44,595
<u>22' 0" WIDE</u>									
119-5824-651	22"	C.O.	C.O.	.197	56	9"	18	8451	\$45,678
119-5824-751	22"	SM.	SM.	.197	56	9"	18	8272	\$45,280
119-5824-851	22"	C.O.	SM.	.197	56	9"	18	8230	\$45,479
<u>23' 4" WIDE</u>									
119-6224-652	22"	C.O.	C.O.	.197	60	9"	22	9182	\$50,775
119-6224-752	22"	SM.	SM.	.197	60	9"	22	9242	\$49,996
119-6224-852	22"	C.O.	SM.	.197	60	9"	22	9212	\$50,404

<u>MODEL NUMBER</u>	<u>DISC DIAM</u>	<u>TYPE OF DISC</u>		<u>DISC THCK</u>	<u># OF DISC</u>	<u>DISC SPACING</u>	<u># OF BRGS</u>	<u>APX WT</u>	<u>SUGST PRICE</u>
		FRNT	REAR						
<u>26' 0" WIDE</u>									
119-7024-652	22"	C.O.	C.O.	.197	68	9"	24	9690	\$54,664
119-7024-752	22"	SM.	SM.	.197	68	9"	24	9758	\$53,780
119-7024-852	22"	C.O.	SM.	.197	68	9"	24	9724	\$54,242

29' 0" WIDE

119-7824-652	22"	C.O.	C.O.	.197	76	9"	24	10203	\$59,326
119-7824-752	22"	SM.	SM.	.197	76	9"	24	10271	\$58,386
119-7824-852	22"	C.O.	SM.	.197	76	9"	24	10237	\$58,856

<u>EXTRA EQUIPMENT</u>								<u>APX WT</u>	<u>SUGST PRICE</u>
9-119-606158	DUAL WHEELS FOR NARROW WING UNITS FOR 19' 6" W/ TWO 15 X 6, SIX LUG WHEELS (DUAL WHEELS STANDARD ON WIDE WINGS 22' 0" & UP)							86#	\$1,060
106122	AG LIGHT KIT							18#	\$500

RECOMMENDED TIRE SIZE: 11L X 15
CAUTION: TIRES ARE RATED AT 20 MPH MAXIMUM.
*PRICE DOES NOT INCLUDE TIRES.

ATHENS 97 LIFT TYPE OFFSET DISK HARROW



SPECIFICATIONS:

Cutting Width 6' 2" to 9' 0"
 22" or 24" Diameter C/O Discs
 Spacing – 9"
 Category II Hitch
 Relube Ball Bearings
 1 ¼" Cold Rolled Square Axle
 with Gang Wrench
 Rigid or Spring Bearing Hangers

<u>MODEL NUMBER</u>	<u>DISC DIAM</u>	<u>TYPE OF DISC</u>		<u>DISC THCK</u>	<u># OF DISC</u>	<u>DISC SPACING</u>	<u># OF BRGS</u>	<u>APX WT</u>	<u>SUGST PRICE</u>
		FRNT	REAR						
<u>6' 2" WIDE</u>									
097-1627-650	22"	C.O.	C.O.	.197	16	9"	6	1337	\$6,432
097-1627-660	24"	C.O.	C.O.	.197	16	9"	6	1385	\$6,712
<u>6' 10" WIDE</u>									
097-1827-650	22"	C.O.	C.O.	.197	18	9"	8	1511	\$7,466
097-1827-660	24"	C.O.	C.O.	.197	18	9"	8	1565	\$7,780
<u>7' 6" WIDE</u>									
097-2027-650	22"	C.O.	C.O.	.197	20	9"	8	1612	\$7,586
097-2027-660	24"	C.O.	C.O.	.197	20	9"	8	1672	\$7,935
<u>WIDE FRAME</u>									
<u>8' 4" WIDE</u>									
097-2227-650	22"	C.O.	C.O.	.197	22	9"	8	1732	\$8,148
097-2227-660	24"	C.O.	C.O.	.197	22	9"	8	1798	\$8,532
<u>9' 0" WIDE</u>									
097-2427-650	22"	C.O.	C.O.	.197	24	9"	8	1826	\$8,923
097-2427-660	24"	C.O.	C.O.	.197	24	9"	8	1898	\$9,342

OPTIONAL EQUIPMENT

For Spring Bearing Hangers:
 Change the 7th Digit from 7 to 6 and add 15#
 and \$75.00 per Bearing to Weights and Prices.

(CONT'D)

EXTRA EQUIPMENT

SCRAPERS

9-097-916270	For 6' 2" Units	190	\$841
*9-097-916260		200	\$925
9-097-918270	For 6' 10" Units	222	\$1,012
*9-097-918260		241	\$1,121
9-097-920270	For 7' 6" Units	242	\$1,083
*9-097-920260		259	\$1,197
9-097-922270	For 8' 4" Units	261	\$1,151
*9-097-922260		278	\$1,265
9-097-924270	For 9' 0" Units	280	\$1,201
*9-097-924260		298	\$1,356

*For Units with Spring Bearing Hangers

COVER DISC

9-097-700018	Cover Disc Assembly with 18" Blade w/o Scraper	20	\$138
9-097-709018	Cover Disc Assembly with 18" Blade w/ Scraper	28	\$161

QUICK HITCH BUSHINGS

101733	Cat. II & III Quick Coupler Adapter for 8' 4" and 9' 0" Units	7	\$123
--------	---------------------------------------------------------------	---	-------

**ATHENS 107 WHEEL TYPE
OFFSET DISK HARROW**

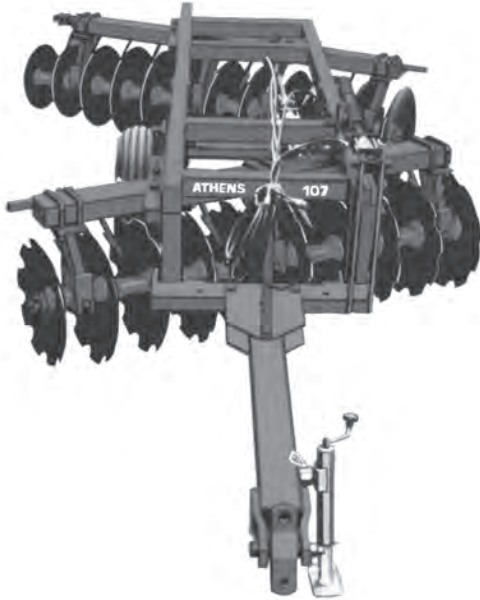

SPECIFICATIONS:

Cutting Width – 6' 2" to 8' 2"
22" or 24" Diameter Discs w /9" Spacing
Relube QUAD Ball Bearings
Gang Axle: 1 ¼" Square
Gang Frames: 3 x 5 x ¼" Tube

STANDARD EQUIPMENT:

Extra Disc on Right Rear
Cover Disc w/ Scraper
Balanced, Reversible Clevis
Heavy Duty Tongue w/ Jack
1 ¼" Cold Rolled Square Axles
w/ Gang Wrench
Heavy Duty Scrapers (Tubular Mtd.)
Wheel Hubs w/ 15" Wheels
Tapered Discs on Rt Rear and Rt Front
Hydraulic Lifting w/ Mechanical Transport

<u>MODEL NUMBER</u>	<u>DISC DIAM</u>	<u>TYPE OF DISC</u>		<u>DISC THCK</u>	<u># OF DISC</u>	<u>DISC SPACING</u>	<u># OF BRGS</u>	<u>APX WT</u>	<u>SUGST PRICE</u>
		FRNT	REAR						
<u>6' 2" WIDE</u>									
107-1727-650	22"	C.O.	C.O.	.197	17	9"	6	2259	\$10,829
107-1727-850	22"	C.O.	SM.	.197	17	9"	6	2268	\$10,655
107-1727-660	24"	C.O.	C.O.	.197	17	9"	6	2334	\$11,080
107-1727-760	24"	SM.	SM.	.197	17	9"	6	2360	\$11,000
107-1727-860	24"	C.O.	SM.	.197	17	9"	6	2347	\$11,037
<u>6' 10" WIDE</u>									
107-1927-650	22"	C.O.	C.O.	.197	19	9"	6	2400	\$11,373
107-1927-850	22"	C.O.	SM.	.197	19	9"	6	2410	\$11,323
107-1927-660	24"	C.O.	C.O.	.197	19	9"	6	2476	\$11,534
107-1927-760	24"	SM.	SM.	.197	19	9"	6	2502	\$11,421
107-1927-860	24"	C.O.	SM.	.197	19	9"	6	2489	\$11,475
<u>7' 6" WIDE</u>									
107-2127-650	22"	C.O.	C.O.	.197	21	9"	6	2514	\$12,041
107-2127-850	22"	C.O.	SM.	.197	21	9"	6	2526	\$11,885
107-2127-660	24"	C.O.	C.O.	.197	21	9"	6	2592	\$12,306
107-2127-760	24"	SM.	SM.	.197	21	9"	6	2618	\$12,197
107-2127-860	24"	C.O.	SM.	.197	21	9"	6	2605	\$12,247
<u>8' 2" WIDE</u>									
107-2327-650	22"	C.O.	C.O.	.197	23	9"	8	2629	\$12,899
107-2327-850	22"	C.O.	SM.	.197	23	9"	8	2642	\$12,726
107-2327-660	24"	C.O.	C.O.	.197	23	9"	8	2708	\$13,127
107-2327-760	24"	SM.	SM.	.197	23	9"	8	2734	\$13,071
107-2327-860	24"	C.O.	SM.	.197	23	9"	8	2720	\$13,098

RECOMMENDED TIRE SIZE: 9.5L x 15
CAUTION: TIRES ARE RATED AT 20 MPH MAXIMUM.
**PRICE DOES NOT INCLUDE TIRES

ATHENS 127 WHEEL TYPE OFFSET DISK HARROW

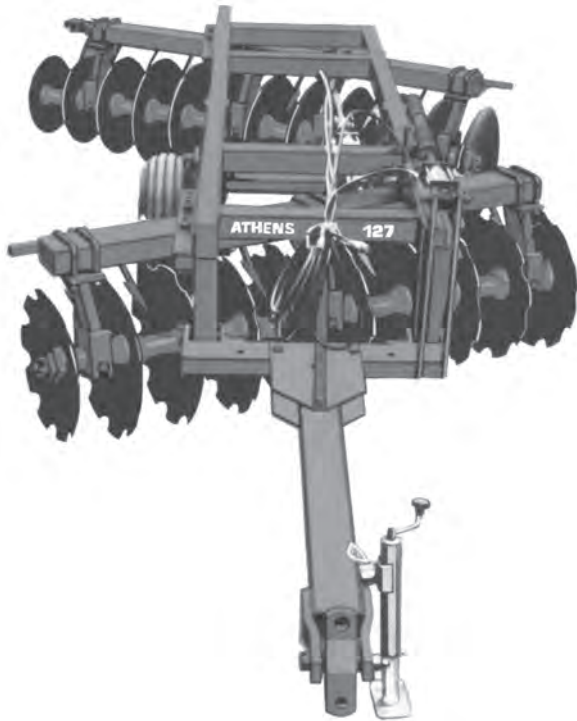

SPECIFICATIONS:

Cutting Width – 6' 6" to 12' 6"
 24" Diameter Discs C/O or SM
 Spacing – 9 1/2"
 Relube QUAD Ball Bearings or
 QUAD Tapered Double Roller Bearings
 w/ Rigid or Spring Bearing Hangers
 Single or Dual Wheels

STANDARD EQUIPMENT:

Extra Disc on Right Rear
 Cover Disc w/ Scraper
 Balanced, Reversible Clevis
 Heavy-Duty Tongue w/Jack
 1 1/2" Cold Rolled Square Axles
 w/ Gang Wrench
 Heavy-Duty Scrapers (Tubular Mtd)
 Wheel Hubs w/ 15" Wheels
 Tapered Discs on Rt Rear & Rt Frt
 Mechanical Transport
 Hydraulic Leveling Complete
 Hydraulic Lifting Complete

<u>MODEL NUMBER</u>	<u>DISC DIAM</u>	<u>TYPE OF DISC</u>		<u>DISC THCK</u>	<u># OF DISC</u>	<u>DISC SPACING</u>	<u># OF BRGS</u>	<u>APX WT</u>	<u>SUGST PRICE</u>
		<u>FRNT</u>	<u>REAR</u>						

127 OFFSET DISK W/ 3 x 5 TUBULAR FRAME & 5 LUG HUBS

6' 6" WIDE

W/ QUAD BALL BEARINGS

127-1747-657	24"	C.O.	C.O.	.256	17	9-1/2"	6	2711	\$14,060
127-1747-757	24"	SM.	SM.	.256	17	9-1/2"	6	2714	\$13,767
127-1747-857	24"	C.O.	SM.	.256	17	9-1/2"	6	2722	\$13,917

W/ QUAD TAPERED DOUBLE ROLLER BEARINGS

127-1745-657	24"	C.O.	C.O.	.256	17	9-1/2"	6	2686	\$15,309
127-1745-757	24"	SM.	SM.	.256	17	9-1/2"	6	2689	\$15,020
127-1745-857	24"	C.O.	SM.	.256	17	9-1/2"	6	2697	\$15,174

7' 3" WIDE

W/ QUAD BALL BEARINGS

127-1947-657	24"	C.O.	C.O.	.256	19	9-1/2"	6	2854	\$14,940
127-1947-757	24"	SM.	SM.	.256	19	9-1/2"	6	2728	\$14,700
127-1947-857	24"	C.O.	SM.	.256	19	9-1/2"	6	2867	\$14,777

W/ QUAD TAPERED DOUBLE ROLLER BEARINGS

127-1945-657	24"	C.O.	C.O.	.256	19	9-1/2"	6	2829	\$16,206
127-1945-757	24"	SM.	SM.	.256	19	9-1/2"	6	2703	\$15,875
127-1945-857	24"	C.O.	SM.	.256	19	9-1/2"	6	2842	\$16,049

<u>MODEL NUMBER</u>	<u>DISC DIAM</u>	<u>TYPE OF DISC</u>		<u>DISC THCK</u>	<u># OF DISC</u>	<u>DISC SPACING</u>	<u># OF BRGS</u>	<u>APX WT</u>	<u>SUGST PRICE</u>
		FRNT	REAR						
<u>8' 0" WIDE</u>									
<u>W/ QUAD BALL BEARINGS</u>									
127-2147-657	24"	C.O.	C.O.	.256	21	9-1/2"	7	3046	\$16,038
127-2147-757	24"	SM.	SM.	.256	21	9-1/2"	7	3055	\$15,667
127-2147-857	24"	C.O.	SM.	.256	21	9-1/2"	7	3060	\$15,824
<u>W/ QUAD TAPERED DOUBLE ROLLER BEARINGS</u>									
127-2145-657	24"	C.O.	C.O.	.256	21	9-1/2"	7	3016	\$17,500
127-2145-757	24"	SM.	SM.	.256	21	9-1/2"	7	3025	\$17,118
127-2145-857	24"	C.O.	SM.	.256	21	9-1/2"	7	3030	\$17,313
<u>8' 9" WIDE</u>									
<u>W/ QUAD BALL BEARINGS</u>									
127-2347-657	24"	C.O.	C.O.	.256	23	9-1/2"	8	3272	\$17,136
127-2347-757	24"	SM.	SM.	.256	23	9-1/2"	8	3296	\$16,731
127-2347-857	24"	C.O.	SM.	.256	23	9-1/2"	8	3287	\$16,926
<u>W/ QUAD TAPERED DOUBLE ROLLER BEARINGS</u>									
127-2345-657	24"	C.O.	C.O.	.256	23	9-1/2"	8	3238	\$18,778
127-2345-757	24"	SM.	SM.	.256	23	9-1/2"	8	3262	\$18,201
127-2345-857	24"	C.O.	SM.	.256	23	9-1/2"	8	3253	\$18,400
<u>127 OFFSET DISK W/ 4 x 6 TUBULAR FRAME & 6 LUG HUBS</u>									
<u>9' 6" WIDE</u>									
<u>W/ QUAD BALL BEARINGS</u>									
127-2547-657	24"	C.O.	C.O.	.256	25	9-1/2"	8	3949	\$20,883
127-2547-757	24"	SM.	SM.	.256	25	9-1/2"	8	3975	\$20,428
127-2547-857	24"	C.O.	SM.	.256	25	9-1/2"	8	3965	\$20,906
<u>W/ QUAD TAPERED DOUBLE ROLLER BEARINGS</u>									
127-2545-657	24"	C.O.	C.O.	.256	25	9-1/2"	8	3916	\$22,580
127-2545-757	24"	SM.	SM.	.256	25	9-1/2"	8	3941	\$22,120
127-2545-857	24"	C.O.	SM.	.256	25	9-1/2"	8	3931	\$22,358
<u>11' 0" WIDE</u>									
<u>W/ QUAD BALL BEARINGS</u>									
127-2947-658	24"	C.O.	C.O.	.256	29	9-1/2"	9	4467	\$22,426
127-2947-758	24"	SM.	SM.	.256	29	9-1/2"	9	4504	\$21,922
127-2947-858	24"	C.O.	SM.	.256	29	9-1/2"	9	4485	\$22,178
<u>W/ QUAD TAPERED DOUBLE ROLLER BEARINGS</u>									
127-2945-658	24"	C.O.	C.O.	.256	29	9-1/2"	9	4379	\$24,086
127-2945-758	24"	SM.	SM.	.256	29	9-1/2"	9	4466	\$23,265
127-2945-858	24"	C.O.	SM.	.256	29	9-1/2"	9	4447	\$23,841
<u>12' 6" WIDE</u>									
<u>W/ QUAD BALL BEARINGS</u>									
127-3347-658	24"	C.O.	C.O.	.256	33	9-1/2"	12	4985	\$24,646
127-3347-758	24"	SM.	SM.	.256	33	9-1/2"	12	5027	\$24,072
127-3347-858	24"	C.O.	SM.	.256	33	9-1/2"	12	5005	\$24,365

<u>MODEL NUMBER</u>	<u>DISC DIAM</u>	<u>TYPE OF DISC</u>		<u>DISC THCK</u>	<u># OF DISC</u>	<u>DISC SPACING</u>	<u># OF BRGS</u>	<u>APX WT</u>	<u>SUGST PRICE</u>
		FRNT	REAR						
<u>12' 6" WIDE W/ QUAD TAPERED DOUBLE ROLLER BEARINGS</u>									
127-3345-658	24"	C.O.	C.O.	.256	33	9-1/2"	12	4935	\$26,358
127-3345-758	24"	SM.	SM.	.256	33	9-1/2"	12	4987	\$25,770
127-3345-858	24"	C.O.	SM.	.256	33	9-1/2"	12	4957	\$26,066

SPECIAL ORDERING INFORMATION:

SPRING BEARING HANGERS W/ TAPERED DOUBLE ROLLER BEARINGS

To order Spring Bearing Hangers, change the 7th digit from a 5 to 4, and add 31# and \$130.00 per bearing to weights and prices for units with QUAD Tapered Double Roller Bearings.

MANUAL LEVELING

To order a turnbuckle for Manual Leveling in place of a cylinder and hoses as listed in the price list, change the 10th digit for 16-23 disc units from "7" to "0" or for 24-33 disc units from "8" to "1" and deduct 13# and \$198.00.

UNITS WITHOUT AN EXTRA DISC ON RIGHT REAR

Units shown in the price list have an extra disc on the right rear and are strongly recommended by ATHENS to improve performance, reduce the need for adjustments, and to allow disking back and forth without an open furrow. To order units with the same number of discs on the front and rear, change 4th and 5th digits to one number lower (as 17 to 16), and reduce the weight by 70# and reduce the price by \$85.00.

EXTRA EQUIPMENT

APX WT SUGST PRICE

9-127-605156 DUAL WHEELS FOR 16-23 DISC UNITS
(DUAL WHEELS STANDARD ON 9' 6" AND UP)

82# \$857

RECOMMENDED TIRE SIZE: NARROW FRAME W/ 5 LUG HUBS, 9.5L X 15
WIDE FRAME W/ 6 LUG HUBS, 11L X 15

CAUTION: TIRES ARE RATED AT 20 MPH MAXIMUM.

*** PRICE DOES NOT INCLUDE TIRES.**

ATHENS 167 WHEEL TYPE OFFSET DISK HARROW

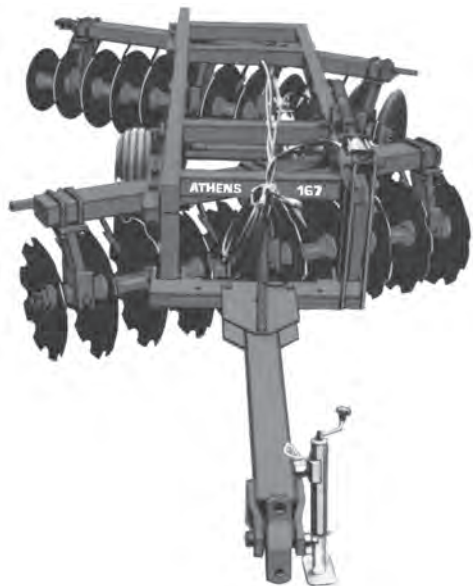

SPECIFICATIONS:

Cutting Width – 7' 1" to 12' 1"
 26" Diameter Discs C/O or SM
 Spacing – 10 ½"
 QUADRASEAL Ball Bearings or
 Tapered Double Roller Bearings w/
 Rigid or Spring Bearing Hangers

STANDARD EQUIPMENT:

Cover Disc w/ Scraper
 Extra Disc on Right Rear
 Heavy-Duty Tongue w/Jack
 Balanced, Reversible Clevis
 1 ½" Cold Rolled Sq. Axle
 Wheel Hubs w/ 15" x 8" Wheels
 Heavy-Duty Scrapers (Tubular Mtd.)
 Tapered Discs on Rt Rear & Rt Frt
 Adjustable Angle of Cut
 Hydraulic Lifting w/ Mech. Transport
 Hydraulic Leveling Complete

<u>MODEL NUMBER</u>	<u>DISC DIAM</u>	<u>TYPE OF DISC</u> FRNT REAR	<u>DISC THCK</u>	<u># OF DISC</u>	<u>DISC SPACING</u>	<u># OF BRGS</u>	<u>APX WT</u>	<u>SUGST PRICE</u>
---------------------	------------------	----------------------------------	------------------	------------------	---------------------	------------------	---------------	--------------------

167 OFFSET DISK W/ 3 x 5 FRAME & 5 LUG HUBS

7' 1" WIDE

W/ QUAD BALL BEARINGS

167-1757-667	26"	C.O. C.O.	.256	17	10-1/2"	8	3077	\$15,883
167-1757-767	26"	SM. SM.	.256	17	10-1/2"	8	3115	\$15,511
167-1757-867	26"	C.O. SM.	.256	17	10-1/2"	8	3096	\$15,698

W/ QUAD TAPERED DOUBLE ROLLER BEARINGS

167-1755-667	26"	C.O. C.O.	.256	17	10-1/2"	8	3121	\$17,510
167-1755-767	26"	SM. SM.	.256	17	10-1/2"	8	3159	\$17,141
167-1755-867	26"	C.O. SM.	.256	17	10-1/2"	8	3140	\$17,311

8' 0" WIDE

W/ QUAD BALL BEARINGS

167-1957-667	26"	C.O. C.O.	.256	19	10-1/2"	8	3246	\$16,952
167-1957-767	26"	SM. SM.	.256	19	10-1/2"	8	3297	\$16,548
167-1957-867	26"	C.O. SM.	.256	19	10-1/2"	8	3277	\$16,758

W/ QUAD TAPERED DOUBLE ROLLER BEARINGS

167-1955-667	26"	C.O. C.O.	.256	19	10-1/2"	8	3290	\$18,613
167-1955-767	26"	SM. SM.	.256	19	10-1/2"	8	3341	\$18,191
167-1955-867	26"	C.O. SM.	.256	19	10-1/2"	8	3321	\$18,403

8' 9" WIDE

W/ QUAD BALL BEARINGS

167-2157-667	26"	C.O. C.O.	.256	21	10-1/2"	8	3437	\$17,998
167-2157-767	26"	SM. SM.	.256	21	10-1/2"	8	3485	\$17,858
167-2157-867	26"	C.O. SM.	.256	21	10-1/2"	8	3461	\$18,087

<u>MODEL NUMBER</u>	<u>DISC DIAM</u>	<u>TYPE OF DISC</u>		<u>DISC THCK</u>	<u># OF DISC</u>	<u>DISC SPACING</u>	<u># OF BRGS</u>	<u>APX WT</u>	<u>SUGST PRICE</u>
		FRNT	REAR						

167 OFFSET DISK W/ 3 x 5 FRAME & 5 LUG HUBS (CONT'D)

8' 9" WIDE W/ QUAD TAPERED DOUBLE ROLLER BEARINGS

167-2155-667	26"	C.O.	C.O.	.256	21	10-1/2"	8	3481	\$20,346
167-2155-767	26"	SM.	SM.	.256	21	10-1/2"	8	3529	\$19,884
167-2155-867	26"	C.O.	SM.	.256	21	10-1/2"	8	3505	\$20,117

167 OFFSET DISK W/ 4 x 6 FRAME & 6 LUG HUBS

9' 7" WIDE W/ QUAD BALL BEARINGS

167-2357-668	26"	C.O.	C.O.	.256	23	10-1/2"	8	4289	\$21,189
167-2357-768	26"	SM.	SM.	.256	23	10-1/2"	8	4342	\$20,724
167-2357-868	26"	C.O.	SM.	.256	23	10-1/2"	8	4316	\$20,943

W/ QUAD TAPERED DOUBLE ROLLER BEARINGS

167-2355-668	26"	C.O.	C.O.	.256	23	10-1/2"	8	4333	\$22,836
167-2355-768	26"	SM.	SM.	.256	23	10-1/2"	8	4386	\$22,350
167-2355-868	26"	C.O.	SM.	.256	23	10-1/2"	8	4360	\$22,592

10' 5" WIDE W/ QUAD BALL BEARINGS

167-2557-668	26"	C.O.	C.O.	.256	25	10-1/2"	8	4488	\$22,080
167-2557-768	26"	SM.	SM.	.256	25	10-1/2"	8	4495	\$21,564
167-2557-868	26"	C.O.	SM.	.256	25	10-1/2"	8	4507	\$21,821

W/ QUAD TAPERED DOUBLE ROLLER BEARINGS

167-2555-668	26"	C.O.	C.O.	.256	25	10-1/2"	8	4532	\$23,731
167-2555-768	26"	SM.	SM.	.256	25	10-1/2"	8	4572	\$23,218
167-2555-868	26"	C.O.	SM.	.256	25	10-1/2"	8	4553	\$23,474

12' 1" WIDE W/QUAD BALL BEARINGS

167-2957-668	26"	C.O.	C.O.	.256	29	10-1/2"	9	4933	\$24,505
167-2957-768	26"	SM.	SM.	.256	29	10-1/2"	9	5000	\$23,916
167-2957-868	26"	C.O.	SM.	.256	29	10-1/2"	9	4967	\$24,214

W/QUAD TAPERED DOUBLE ROLLER BEARINGS

167-2955-668	26"	C.O.	C.O.	.256	29	10-1/2"	9	4977	\$26,540
167-2955-768	26"	SM.	SM.	.256	29	10-1/2"	9	5044	\$25,922
167-2955-868	26"	C.O.	SM.	.256	29	10-1/2"	9	5011	\$25,781

SPECIAL ORDER INFORMATION:

SPRING BEARING HANGERS WITH QUAD TAPERED DOUBLE ROLLER BEARINGS

To order Spring Bearing Hangers, change the 7th digit from a "5" to "4", and add 25# and \$130.00 per bearing to weights and prices for units with QUAD Tapered Double Roller Bearings.

SPECIAL ORDER INFORMATION CONT'D

MANUAL LEVELING

To order a turnbuckle for Manual Leveling in place of a cylinder and hoses as listed in the price list, change the 10th digit for 16-21 disc units from a "7" to "0", or for 22-29 disc units from an "8" to "1" and deduct 12# and \$198.00.

UNITS WITHOUT AN EXTRA DISC ON RIGHT REAR

Units shown in the price list have an extra disc on the right rear and are strongly recommended by ATHENS to improve performance, reduce the need for adjustments, and to allow disking back and forth without an open furrow. To order units with the same number of discs on the front and rear, change 4th and 5th digits to one number lower (as 17 to 16), reduce weight by 100# and reduce the price by \$117.00.

<u>EXTRA EQUIPMENT</u>	<u>APX WT</u>	<u>SUGST PRICE</u>
9-167-605156 DUAL WHEELS FOR 16-21 DISC UNITS (DUAL WHEELS STANDARD ON 9' 7" AND UP)	82#	\$857

RECOMMENDED TIRE SIZE: NARROW FRAME W/ 5 LUG HUBS, 9.5L X 15
WIDE FRAME W/ 6 LUG HUBS, 11L X 15

CAUTION: TIRES ARE RATED AT 20MPH MAXIMUM.

***PRICE DOES NOT INCLUDE TIRES.**

ATHENS 137 WHEEL TYPE OFFSET DISK HARROW

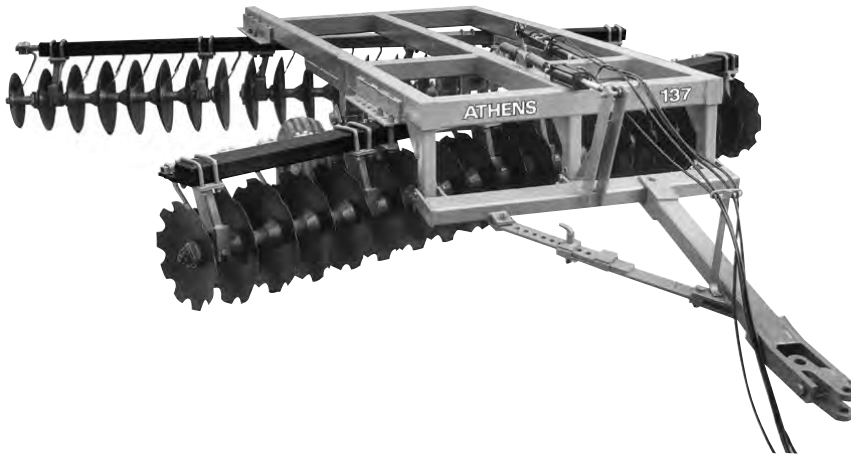

SPECIFICATIONS:

Cutting Width – 12' 6" to 18' 6"
 24" Diameter Disc C/O or SM
 Spacing – 9 1/2"
 Relube QUADRASEAL Ball or
 Tapered Double Roller Bearings
 Rigid or Spring Bearing Hangers

STANDARD EQUIPMENT:

Extra Disc on Right Rear
 Cover Disc w/ Scraper
 Balanced, Reversible Clevis
 1-1/2" Cold Rolled Sq. Axles
 w/ Gang Wrench
 Dual 15" x 8" 6-Lug Wheels w/ Hubs
 Heavy Duty Scrapers (Tubular Mtd.)
 Hydraulic Lifting w/Mech Transport
 Tapered Discs on Rt Rear and Rt Frt
 Adjustable Angle of Cut
 Hydraulic Leveling Complete

<u>MODEL NUMBER</u>	<u>DISC DIAM</u>	<u>TYPE OF DISC</u>		<u>DISC THCK</u>	<u># OF DISC</u>	<u>DISC SPACING</u>	<u># OF BRGS</u>	<u>APX WT</u>	<u>SUGST PRICE</u>
<u>12' 6" WIDE</u>									
<u>W/ QUAD BALL BEARINGS</u>									
137-3347-659	24"	C.O.	C.O.	.256	33	9-1/2"	8	5444	\$26,259
137-3347-759	24"	SM.	SM.	.256	33	9-1/2"	8	5473	\$25,699
137-3347-859	24"	C.O.	SM.	.256	33	9-1/2"	8	5449	\$25,993
<u>W/ RELUBE QUAD TAPERED DOUBLE ROLLER BEARINGS</u>									
137-3345-659	24"	C.O.	C.O.	.256	33	9-1/2"	8	5410	\$28,044
137-3345-759	24"	SM.	SM.	.256	33	9-1/2"	8	5439	\$27,467
137-3345-859	24"	C.O.	SM.	.256	33	9-1/2"	8	5415	\$27,763
<u>14' 0" WIDE</u>									
<u>W/ QUAD BALL BEARINGS</u>									
137-3747-659	24"	C.O.	C.O.	.256	37	9-1/2"	9	5831	\$28,346
137-3747-759	24"	SM.	SM.	.256	37	9-1/2"	9	5881	\$27,693
137-3747-859	24"	C.O.	SM.	.256	37	9-1/2"	9	5854	\$28,041
<u>W/ RELUBE QUAD TAPERED DOUBLE ROLLER BEARINGS</u>									
137-3745-659	24"	C.O.	C.O.	.256	37	9-1/2"	9	5797	\$30,317
137-3745-759	24"	SM.	SM.	.256	37	9-1/2"	9	5847	\$29,661
137-3745-859	24"	C.O.	SM.	.256	37	9-1/2"	9	5820	\$30,012

<u>MODEL NUMBER</u>	<u>DISC DIAM</u>	<u>TYPE OF DISC</u>		<u>DISC THCK</u>	<u># OF DISC</u>	<u>DISC SPACING</u>	<u># OF BRGS</u>	<u>APX WT</u>	<u>SUGST PRICE</u>	
		FRNT	REAR							
<u>15' 6" WIDE</u>		<u>W/ QUAD BALL BEARINGS</u>								
137-4147-659	24"	C.O.	C.O.	.256	41	9-1/2"	12	6562	\$31,076	
137-4147-759	24"	SM.	SM.	.256	41	9-1/2"	12	6618	\$30,349	
137-4147-859	24"	C.O.	SM.	.256	41	9-1/2"	12	6588	\$30,730	
		<u>W/ RELUBE QUAD TAPERED DOUBLE ROLLER BEARINGS</u>								
137-4145-659	24"	C.O.	C.O.	.256	41	9-1/2"	12	6512	\$33,593	
137-4145-759	24"	SM.	SM.	.256	41	9-1/2"	12	6568	\$32,865	
137-4145-859	24"	C.O.	SM.	.256	41	9-1/2"	12	6538	\$32,492	
<u>17' 0" WIDE</u>		<u>W/ QUAD BALL BEARINGS</u>								
137-4547-659	24"	C.O.	C.O.	.256	45	9-1/2"	12	6877	\$32,440	
137-4547-759	24"	SM.	SM.	.256	45	9-1/2"	12	6939	\$31,638	
137-4547-859	24"	C.O.	SM.	.256	45	9-1/2"	12	6906	\$32,060	
		<u>W/ RELUBE QUAD TAPERED DOUBLE ROLLER BEARINGS</u>								
137-4545-659	24"	C.O.	C.O.	.256	45	9-1/2"	12	6827	\$34,790	
137-4545-759	24"	SM.	SM.	.256	45	9-1/2"	12	6889	\$33,949	
137-4545-859	24"	C.O.	SM.	.256	45	9-1/2"	12	6856	\$34,376	
<u>18' 6" WIDE</u>		<u>W/ QUAD BALL BEARINGS</u>								
137-4947-659	24"	C.O.	C.O.	.256	49	9-1/2"	12	7246	\$33,802	
137-4947-759	24"	SM.	SM.	.256	49	9-1/2"	12	7314	\$32,924	
137-4947-859	24"	C.O.	SM.	.256	49	9-1/2"	12	7278	\$33,387	
		<u>W/ RELUBE QUAD TAPERED DOUBLE ROLLER BEARINGS</u>								
137-4945-659	24"	C.O.	C.O.	.256	49	9-1/2"	12	7196	\$36,355	
137-4945-759	24"	SM.	SM.	.256	49	9-1/2"	12	7264	\$35,466	
137-4945-859	24"	C.O.	SM.	.256	49	9-1/2"	12	7228	\$35,932	

SPECIAL ORDERING INFORMATION:

SPRING BEARING HANGERS WITH QUAD TAPERED DOUBLE ROLLER BEARINGS

To order Spring Bearing Hangers, change the 7th digit from a "5" to "4" and add 31# and \$130.00 per bearing to weights and prices for units with QUAD Tapered Double Roller Bearings.

MANUAL LEVELING

To replace the cylinder and hoses w/ a turnbuckle, change the 10th digit from a "9" to "0" and deduct 13# and \$198.00.

UNITS WITHOUT AN EXTRA DISC ON RIGHT REAR

Units shown in the price list have an extra disc on the right rear and are strongly recommended by ATHENS to improve performance, reduce the need for adjustments, and to allow disking back and forth without an open furrow. To order units with the same number of discs on the front and rear, change 4th and 5th digits to one number lower (as 33 to 32), reduce the weight by 70# and reduce the price by \$85.00.

106166 AG LIGHT KIT 19# \$500.00

RECOMMENDED TIRE SIZE: 11L x 15 (4 REQUIRED)

CAUTION: TIRES ARE RATED AT 20 MPH MAXIMUM.

***PRICE DOES NOT INCLUDE TIRES.**

ATHENS 187 WHEEL TYPE OFFSET DISK HARROW

SPECIFICATIONS:

Cutting Width – 12' 1" to 17' 1"
 26" Diameter Disc C/O or SM
 Spacing – 10 1/2"
 Relube QUADRASEAL Ball Bearings or
 Tapered Double Roller Bearings w/
 Rigid or Spring Bearing Hangers

STANDARD EQUIPMENT:

Cover Disc w/ Scraper
 Extra Disc on Right Rear
 Heavy Duty Tongue w/ Jack
 Balanced, Reversible Clevis
 1 1/2" Cold Rolled Sq. Axle
 w/ Gang Wrench
 Dual 15" x 8" 6 Lug Wheels w/ Hub
 Heavy Duty Scrapers (Tubular Mtd.)
 Tapered Discs on Right Rear & Rt Frt
 Adjustable Angle of Cut
 Hydraulic Leveling Complete
 Hydraulic Lifting w/ Mech. Transport

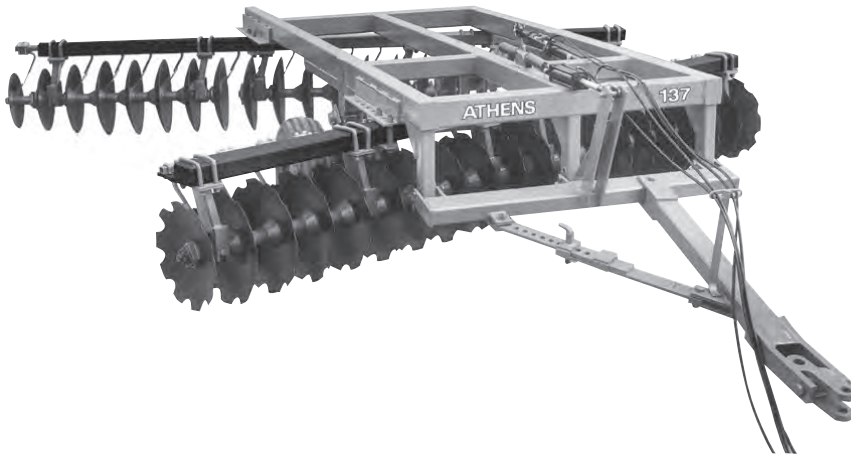

<u>MODEL NUMBER</u>	<u>DISC DIAM</u>	<u>TYPE OF DISC</u>		<u>DISC THCK</u>	<u># OF DISC</u>	<u>DISC SPACING</u>	<u># OF BRGS</u>	<u>APX WT</u>	<u>SUGST PRICE</u>
		<u>FRNT</u>	<u>REAR</u>						
<u>12' 1" WIDE</u>									
<u>W/ RELUBE QUAD BALL BEARINGS</u>									
187-2957-669	26"	C.O.	C.O.	.256	29	10-1/2"	10	5517	\$27,734
187-2957-769	26"	SM.	SM.	.256	29	10-1/2"	10	5585	\$27,214
187-2957-869	26"	C.O.	SM.	.256	29	10-1/2"	10	5552	\$27,483
<u>W/ RELUBE QUAD TAPERED DOUBLE ROLLER BEARINGS</u>									
187-2955-669	26"	C.O.	C.O.	.256	29	10-1/2"	10	5561	\$29,726
187-2955-769	26"	SM.	SM.	.256	29	10-1/2"	10	5629	\$29,265
187-2955-869	26"	C.O.	SM.	.256	29	10-1/2"	10	5596	\$29,543
<u>13' 9" WIDE</u>									
<u>W/ RELUBE QUAD BALL BEARINGS</u>									
187-3357-669	26"	C.O.	C.O.	.256	33	10-1/2"	12	6147	\$30,679
187-3357-769	26"	SM.	SM.	.256	33	10-1/2"	12	6225	\$30,079
187-3357-869	26"	C.O.	SM.	.256	33	10-1/2"	12	6187	\$30,389
<u>W/ RELUBE QUAD TAPERED DOUBLE ROLLER BEARINGS</u>									
187-3355-669	26"	C.O.	C.O.	.256	33	10-1/2"	12	6213	\$33,098
187-3355-769	26"	SM.	SM.	.256	33	10-1/2"	12	6309	\$32,506
187-3355-869	26"	C.O.	SM.	.256	33	10-1/2"	12	6253	\$32,810
<u>15' 5" WIDE</u>									
<u>W/ RELUBE QUAD BALL BEARINGS</u>									
187-3757-669	26"	C.O.	C.O.	.256	37	10-1/2"	12	6581	\$32,729
187-3757-769	26"	SM.	SM.	.256	37	10-1/2"	12	6669	\$32,058
187-3757-869	26"	C.O.	SM.	.256	37	10-1/2"	12	6636	\$32,420

<u>MODEL NUMBER</u>	<u>DISC DIAM</u>	<u>TYPE OF DISC</u>		<u>DISC THCK</u>	<u># OF DISC</u>	<u>DISC SPACING</u>	<u># OF BRGS</u>	<u>APX WT</u>	<u>SUGST PRICE</u>
		<u>FRNT</u>	<u>REAR</u>						
<u>15' 5" WIDE</u>		<u>W/ RELUBE QUAD TAPERED DOUBLE ROLLER BEARINGS</u>							
187-3755-669	26"	C.O.	C.O.	.256	37	10-1/2"	12	6647	\$35,203
187-3755-769	26"	SM.	SM.	.256	37	10-1/2"	12	6735	\$34,515
187-3755-869	26"	C.O.	SM.	.256	37	10-1/2"	12	6702	\$34,875
<u>17' 1" WIDE</u>		<u>W/ RELUBE QUAD BALL BEARINGS</u>							
187-4157-669	26"	C.O.	C.O.	.256	41	10-1/2"	12	7085	\$34,739
187-4157-769	26"	SM.	SM.	.256	41	10-1/2"	12	7182	\$34,100
187-4157-869	26"	C.O.	SM.	.256	41	10-1/2"	12	7134	\$34,384
		<u>W/ RELUBE QUAD TAPERED DOUBLE ROLLER BEARINGS</u>							
187-4155-669	26"	C.O.	C.O.	.256	41	10-1/2"	14	7151	\$37,246
187-4155-769	26"	SM.	SM.	.256	41	10-1/2"	14	7248	\$36,469
187-4155-869	26"	C.O.	SM.	.256	41	10-1/2"	14	7200	\$36,872

SPECIAL ORDER INSTRUCTIONS:

SPRING BEARING HANGERS W/QUAD TAPERED DOUBLE ROLLER BEARINGS

To order Spring Bearing Hangers, Change the 7th digit from "5" to "4", and add 25# and \$130.00 per bearing to weights and prices for units with QUAD Tapered Double Roller Bearings.

UNITS WITHOUT AND EXTRA DISC ON RIGHT REAR

Units shown in the price list have an extra disc on the right rear and are strongly recommended by ATHENS to improve performance, reduce the need for adjustments, and to allow disking back and forth without an open furrow. To order units with the same number of discs on front and rear, change 4th and 5th digits to one number lower (as 33 to 32), reduce weight by 107# and reduce price by \$117.00.

MANUAL LEVELING

To replace the cylinder and hoses w/ a turnbuckle, change the 10th digit from a "9" to "0" and deduct 13# and \$198.00.

106166 AG LIGHT KIT 19# \$500.00

RECOMMENDED TIRE SIZE: 11L X 15 (4 REQUIRED)

CAUTION: TIRES ARE RATED AT 20 MPH MAXIMUM.

***PRICE DOES NOT INCLUDE TIRES.**

ATHENS 287 OFFSET DISK HARROW

SPECIFICATIONS:

Cutting Width – 8' to 16'
 Disc Spacing – 12"
 Disc Blades – 28" or 32" C/O
 Relube 2" Ball Bearings

STANDARD EQUIPMENT

Cover Disc w/ Scraper
 Hydraulic Leveling Complete
 Hydraulic Lifting Complete
 Balanced, Reversible Clevis
 Heavy Duty Tube Mounted Scrapers
 Tapered Rear Gang
 15" x 8" Six Lug Wheels w/
 Dual Wheel Hubs
 2" Cold Rolled Square Gang Axles

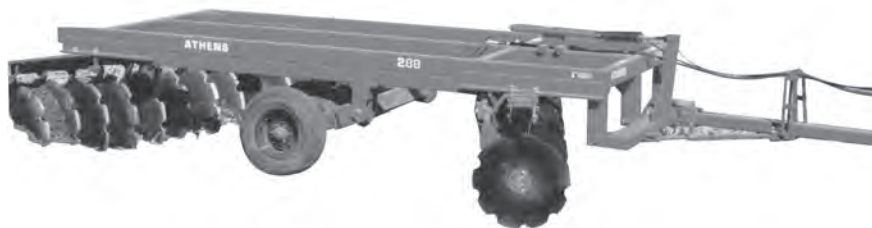

<u>MODEL NUMBER</u>	<u>DISC DIAM</u>	<u>TYPE OF DISC</u>	<u>DISC THCK</u>	<u># OF DISC</u>	<u>DISC SPACING</u>	<u># OF BRGS</u>	<u>APX WT</u>	<u>SUGST PRICE</u>
<u>8' 0" WIDE</u>		<u>W/ RELUBE BALL BEARINGS</u>						
287-1722-688	28"	C.O.	.31	17	12"	8	5221	\$28,451
287-1722-628	32"	C.O.	.39	17	12"	8	5750	\$31,940
<u>9' 0" WIDE</u>		<u>W/ RELUBE BALL BEARINGS</u>						
287-1922-688	28"	C.O.	.31	19	12"	8	5490	\$29,374
287-1922-628	32"	C.O.	.39	19	12"	8	6165	\$33,489
<u>10' 0" WIDE</u>		<u>W/ RELUBE BALL BEARINGS</u>						
287-2122-688	28"	C.O.	.31	21	12"	8	5812	\$30,958
287-2122-628	32"	C.O.	.39	21	12"	8	6505	\$35,075
<u>12' 0" WIDE</u>		<u>W/ RELUBE BALL BEARINGS</u>						
287-2522-688	28"	C.O.	.31	25	12"	8	7867	\$38,855
287-2522-628	32"	C.O.	.39	25	12"	8	8710	\$42,956
<u>14' 0" WIDE</u>		<u>W/ RELUBE BALL BEARINGS</u>						
287-2922-688	28"	C.O.	.31	29	12"	12	8650	\$42,475
287-2922-628	32"	C.O.	.39	29	12"	12	9473	\$46,816
<u>16' 0" WIDE</u>		<u>W/ RELUBE BALL BEARINGS</u>						
287-3322-688	28"	C.O.	.31	33	12"	12	9250	\$45,535
287-3322-628	32"	C.O.	.39	33	12"	12	10005	\$49,253

****To Order a Model 288 Change the 3rd Digit to an 8 and add \$1,256.00 Per Bearing.**

RECOMMENDED TIRE SIZE: 11L x 15 (4 REQUIRED)
 CAUTION: TIRES ARE RATED AT 20 MPH MAXIMUM.

***PRICE DOES NOT INCLUDE TIRES.**

ATHENS 156 MOUNTED CHISEL PLOW



SPECIFICATIONS:

Lift Type – 5', 7', 10', 11' Bases
 2 Bar Lift Type – 5' to 15'
 3 Bar Lift Type – 7' to 16'
 1 x 2 x 26", 1 x 2 x 32" &
 1 ¼ x 2 x 32" Alloy Steel Tines
 5/8" Chisel Points or
 3/8" Twisted Shovels

STANDARD EQUIPMENT

Cushion Spring Clamps
 4 x 4" Tubular Frame
 12" Tine Spacing

MODEL NUMBER	TINE ATTACHMENT	TINE SIZE			SIZE (CAT) HITCH	APX WT	SUGST PRICE
		1 x 26"	1 x 32"	1.25 x 32"			
<u>5' 0" WIDE</u>		<u>W/ RIGID TINE ATTACHMENT, 26" TINES & 5/8" POINTS</u>					
156-0521-221	RGD	X			I	580	\$2,645
156-0521-222	RGD	X			II	580	\$2,645
<u>7' 0" WIDE</u>		<u>W/ RIGID TINE ATTACHMENT, 26" TINES & 5/8" POINTS</u>					
156-0721-223	RGD	X			II	732	\$3,548
		<u>2 – BAR LIFT TYPE W/ SPRING TINE ATTACHMENT & 5/8" POINTS</u>					
<u>5' 0" WIDE</u>		<u>W/ CATEGORY I OR II HITCH PINS</u>					
156-0522-221	SPG	X			I	736	\$3,867
156-0522-321	SPG		X		I	766	\$3,990
156-0522-421	SPG			X	I	822	\$4,351
156-0522-222	SPG	X			II	737	\$3,867
156-0522-322	SPG		X		II	767	\$3,990
156-0522-422	SPG			X	II	822	\$4,351
<u>7' 0" WIDE</u>		<u>W/ CATEGORY II HITCH PINS</u>					
156-0722-223	SPG	X			II	952	\$4,722
156-0722-323	SPG		X		II	994	\$4,895
156-0722-423	SPG			X	II	1001	\$5,400
<u>11' 0" WIDE</u>		<u>W/ CATEGORY II HITCH PINS</u>					
156-1122-223	SPG	X			II	1243	\$6,822
156-1122-323	SPG		X		II	1452	\$7,103
156-1122-423	SPG			X	II	1573	\$7,893

<u>MODEL NUMBER</u>	<u>TINE ATTCH MENT</u>	<u>TINE SIZE</u>			<u>SIZE (CAT) HITCH</u>	<u>APX WT</u>	<u>SUGST PRICE</u>
		<u>1 x 26"</u>	<u>1 x 32"</u>	<u>1.25 x 32"</u>			
		*** SINGLE EXTENSION FOR TWO-BAR UNITS***			(SINGLE EXTENIONS ARE COMPLETE)		
		<u>W/ 5/8" CHISEL POINTS</u>					
<u>2' 0"</u>							
9-156-022122	RGD	X			N/A	198	\$714
9-156-022222	SPG	X			N/A	198	\$1,124
9-156-022232	SPG		X		N/A	210	\$1,187
9-156-022242	SPG			X	N/A	232	\$1,320
		DOUBLE EXTENSION FOR TWO-BAR UNITS			(USED ONLY WITH SINGLE EXTENSIONS)		
		<u>W/ 5/8" CHISEL POINTS</u>					
<u>2' 0"</u>							
9-156-042122	RGD	X			N/A	253	\$887
9-156-042222	SPG	X			N/A	253	\$1,405
9-156-042232	SPG		X		N/A	265	\$1,433
9-156-042242	SPG			X	N/A	287	\$1,598
<u>3-BAR W/ SPRING TINE ATTACHMENT & 5/8" POINTS</u>							
<u>7' 0" WIDE</u>		<u>W/ CATEGORY II HITCH</u>					
156-0732-223	SPG	X			II	1089	\$5,468
156-0732-323	SPG		X		II	1131	\$5,649
156-0732-423	SPG			X	II	1208	\$6,146
<u>10' 0" WIDE</u>		<u>W/ CATEGORY II-III HITCH</u>					
156-1032-223	SPG	X			II & III	1458	\$7,123
156-1032-323	SPG		X		II & III	1518	\$7,368
156-1032-423	SPG			X	II & III	1628	\$8,102
		SINGLE EXTENSION FOR THREE BAR UNITS			(SINGLE EXTENSIONS ARE COMPLETE)		
		<u>W/ 5/8" CHISEL POINTS</u>					
<u>2' 0"</u>							
9-156-023222	SPG	X			N/A	199	\$1,137
9-156-023232	SPG		X		N/A	211	\$1,192
9-156-023242	SPG			X	N/A	233	\$1,334
		DOUBLE EXTENSION FOR THREE-BAR UNITS			(USED ONLY WITH SINGLE EXTENSIONS)		
		<u>W/ 5/8" CHISEL POINTS</u>					
<u>2' 0"</u>							
9-156-043222	SPG	X			N/A	268	\$1,386
9-156-043232	SPG		X		N/A	280	\$1,434
9-156-043242	SPG			X	N/A	302	\$1,531

MODEL NUMBER	TINE ATTCH MENT	TINE SIZE			SIZE (CAT) HITCH	APX WT	SUGST PRICE
		1 x 26"	1 x 32"	1.25 x 32"			
TRIPLE EXTENSION FOR THREE-BAR UNITS <u>W/ 5/8" CHISEL POINTS</u>					(TRIPLE EXTENSIONS ARE COMPLETE)		
<u>6' 0"</u>							
9-156-063222	SPG	X			N/A	770	\$4,142
9-156-063232	SPG		X		N/A	806	\$4,301
9-156-063242	SPG			X	N/A	872	\$4,722

EXTRA EQUIPMENT

					APX WT	SUGST PRICE
9-156-520516	GAUGE WHEELS (2 BAR UNITS ONLY) 2-15 WHEELS LESS TIRES				167#	\$1,174
9-156-530516	GAUGE WHEELS (3 BAR UNITS ONLY) 2-15 WHEELS LESS TIRES				169#	\$1,191
101733	CAT II & III QUICK COUPLER ADAPTER FOR 10' UNITS				7#	\$130
101746	CAT II QUICK COUPLER ADAPTER FOR 7' UNITS AND 11' UNITS				1#	\$56

***WHEN ORDERING EXTENSIONS: SINGLE EXTENSIONS ARE COMPLETE AND CAN BE USED ALONE.
DOUBLE EXTENSIONS ARE NOT COMPLETE AND MUST BE USED ONLY WITH SINGLE EXTENSIONS
TRIPLE EXTENSIONS ARE COMPLETE AND CAN BE USED ALONE.

OPTIONAL EQUIPMENT:

For 3/8" Twisted Shovels, change the 9th digit from 2 to 3, add 1# each and \$8.00 each to weights and prices for units with 5/8" Chisel Points shown in the price list.

RECOMMENDED TIRE SIZE FOR GAUGE WHEELS: 9.5L X 15 (2 REQUIRED)

CAUTION: TIRES ARE RATED AT 20 MPH MAXIMUM.

***PRICE DOES NOT INCLUDE TIRES**

**ATHENS 220 HEAVY DUTY
LEVEE PLOW**

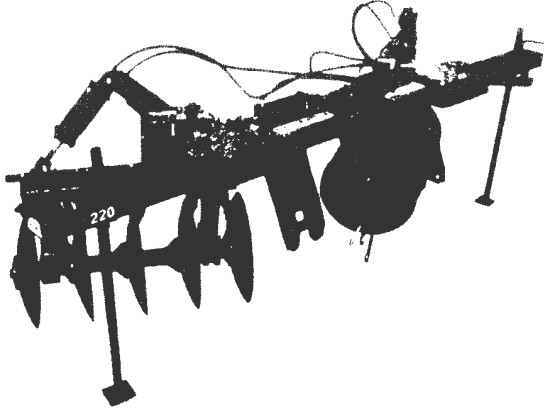

SPECIFICATIONS:

Eight or Ten Disc Models
Tapered Twelve Disc Models
24" or 26" Disks, Cutout or Smooth
.256" Disk Thickness

STANDARD EQUIPMENT:

10 1/2" Disk Blade Spacing
Cat II-III Heavy Duty Hitch
QUADRASEAL Tapered Double
Roller Bearings
1 1/2" Cold Rolled Square Axle
Disk Gang Assembly Wrench
1/2 x 4 x 7 x 136" Tool Bar
Two Parking Stands
Heavy Duty Scrapers

<u>MODEL NUMBER</u>	<u>DISC DIAM</u>	<u>TYPE OF DISC</u>	<u>DISC THCK</u>	<u># OF DISC</u>	<u>DISC SPACING</u>	<u>APX WT</u>	<u>SUGST PRICE</u>
<u>W/ MANUAL ADJUSTMENT & SHALLOW CONCAVITY BLADES</u>							
220-0855-191	24"	SM.	.256	8	10-1/2"	2181	\$10,690
220-1055-191	24"	SM.	.256	10	10-1/2"	2317	\$11,456
<u>W/ HYDRAULIC ADJUSTMENT & SHALLOW CONCAVITY BLADES</u>							
220-0855-194	24"	SM	.256	8	10-1/2"	2221	\$13,029
220-1055-194	24"	SM	.256	10	10-1/2"	2357	\$13,792

SPECIAL ORDER INSTRUCTIONS:

24" x .256 Cutout Blades. To order 24" cutout blades, change 8th & 9th digits to 04 and deduct 2# per blade and add \$16.00 per blade.

26" x .256 Smooth Blades. To order 26" smooth blades, change 8th & 9th digits to 16 and add 6# per blade and add \$26.00 per blade.

26" x .256 Cutout Blades. To order 26" cutout blades, change 8th & 9th digits to 06 and add 3# per blade and add \$4 0.00 per blade.

TAPERED BLADES WITH MANUAL ADJUSTMENT

220-1255-TAP	SM	12	10-1/2"	2356	\$11,456
--------------	----	----	---------	------	----------

TAPERED BLADES WITH HYDRAULIC ADJUSTMENT

220-1255-TAPH	SM	12	10-1/2"	2396	\$13,792
---------------	----	----	---------	------	----------

NOTE: 221 is the same as 220 except that 221 is equipped with Cover Discs and Cover Disc Scrapers. To order a Model 221, change 220 to 221 and add 66# and \$310.00 to the prices shown in the price list.

**INSIDE BACK COVER
BLANK**

ATHENS performance

Since 1921 Athens Tillage Products have been known for their rugged quality and superior performance. We have a complete line of Lift Type Harrows, Tandem Disks, Offset and Double Offset Disk Plows, Chisel Plows, and Levee Plows.

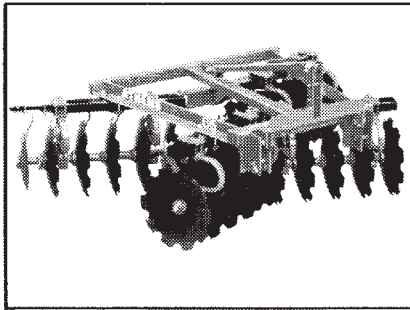

MODEL - 065 LIFT TYPE HARROW
WIDTH - 8'0" to 9'6"
WEIGHT - 1710# to 1968#

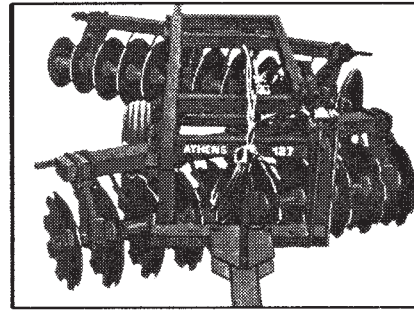

MODEL - 127/167 - OFFSET HARROW
WIDTH - 6'6" to 12'6"
WEIGHT - 2752# to 4870#

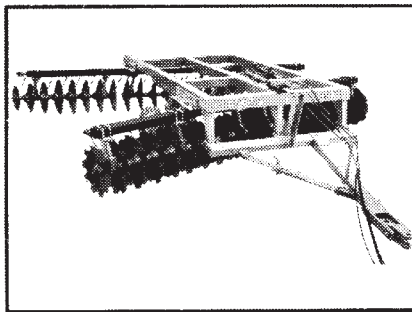

MODEL - 137/187 OFFSET HARROW
WIDTH - 12'6" to 18'6"
WEIGHT - 5367# to 7076#

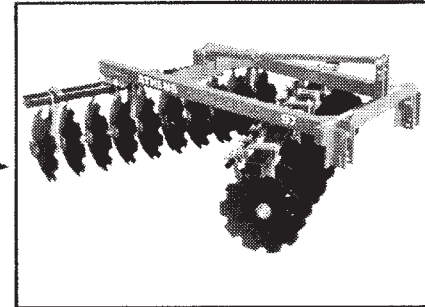

MODEL - 097 LIFT TYPE OFFSET
WIDTH - 6'2" to 7'6"
WEIGHT - 1385# to 1672#

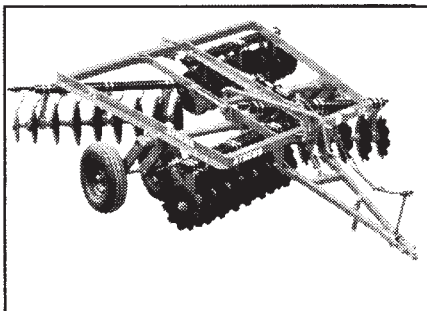

MODEL - 76/77 DOUBLE OFFSET
WIDTH - 8'10" to 15'9"
WEIGHT - 2900# to 4528#

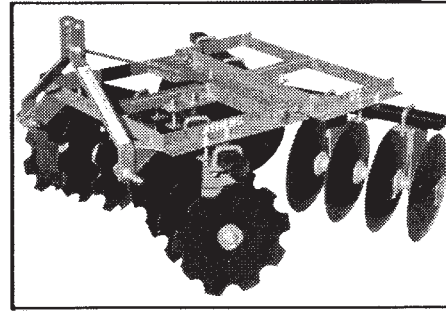

MODEL - 37 LIFT TYPE HARROW
WIDTH - 5'2" to 6'5"
WEIGHT - 640# to 722#

DEPENDABILITY

RELIABILITY

QUALITY



VALUE

SERVICE

PERFORMANCE

TAB 2



Fertilizer Spreaders *Spreads Seed or Fertilizer*

The FS Series spreader features easily controlled seed gates, adjustable spreading vanes and a left/right spread control. Options include salt-sand deflector kit.

Model	Code	Features	Weight (lbs)	Set-Up	Price
3 Point Hitch Fertilizer Spreader					
FS-150	804-003	150 Litre or 317 lbs Cap Steel Hopper complete with standard agitator and PTO Shaft.		\$80.00	\$980.00
FS-300	804-004	250 Litre or 694 lbs Cap Steel Hopper complete with standard agitator and PTO Shaft.	105	\$80.00	\$1,009.00
FS-500	804-001	338 Litre or 992 lbs Cap Steel Hopper complete with standard agitator and PTO Shaft.	115	\$80.00	\$1,055.00
Options					
400.091		FS-FP Salt/Sand Deflector Kit			\$379.00
400.200		Agitator for powder fertilizer			\$101.00
400.168		Lateral conveyor kit			\$1,058.00
Pull type Fertilizer Spreader					
804.019		FSP100 STD, 100 Litre or 26.5 USA Gallon Cap Steel Hopper complete with standard agitator.		\$100.00	\$1,870.00
804.020		FSP150 STD, 144 Litre or 38 USA Gallon Cap Steel Hopper complete with standard agitator.		\$100.00	\$1,902.00
400.195		FSP-PAR2000 Salt/Sand Spreader Complete Kit			\$379.00
Options					
		Turf Tires			\$353.00
		Hitch for ATV's			\$168.00
400.245		XAR3000-TS/TSP Salt/Sand Deflector Complete Kit			\$379.00

FS Series



FSP Series



PRICED IN CANADIAN DOLLARS

PRICES ARE FOB HARRISTON, ON- DESIGN & PRICE ARE SUBJECT TO CHANGE WITHOUT NOTICE

TAB 3

SILAGE PACKER

Standard Features

- Available with 30" steel wheels.
- 3" wide stainless-steel rims.
- 5" axle gives up to 12" packing depth.
- When silage is properly packed there will be very little wheel penetration
- Bolt on 3-point hitch bracket in 3N, 3, 4N or 4 are included in price, customer to specify.



Model #	Description	Lbs.	HP	Price (Cdn)
2907	7-wheel w/weight boxes/w sand*, 93" wide	7000	190	\$22,747.00
2909	9-wheel w/weight boxes/w sand*, 123" wide	9000	230	\$28,729.00
2911	11-wheel w/weight boxes/w sand*, 153" wide	11000	280+	\$35,314.00
	<i>*customer supplied sand</i>			



PRICED IN CANADIAN DOLLARS

PRICES ARE FOB HARRISTON, ONTARIO – DESIGN & PRICE ARE SUBJECT TO CHANGE WITHOUT NOTICE

Bale Buddy 2000



The Bale Buddy 2000 was designed to allow hay to be baled while there is up to 60% moisture in the hay. When the weather is uncooperative, this will save time waiting for the hay to dry and product with less hay spoilage.



Bale Buddy 2000 Specs

SPECS	VALUE
LENGTH	72" (183cm)
WIDTH	40" (102cm) BASE 104" (264cm) TOP
HEIGHT	90" (229cm)
WEIGHT	853 lbs. (382 kg)
BALE SIZE	4x5 or 5x6
CONNECTIONS	14 Pin
WRAP	Standard Film Wrap
HYDRAULICS	Auxillary Hydraulics

BALE BUDDY 2000 - CDN PRICE - \$8,373.00

PRICES ARE FOB HARRISTON, ONTARIO – DESIGN & PRICE ARE SUBJECT TO CHANGE WITHOUT NOTICE January 1, 2025



Made in Northern Minnesota



Date Change Only

ReCon

Features Include:	
<ul style="list-style-type: none"> ▪ Adjustable top deflector ▪ Inline quick adjuster for roller spacing 	
Standard Equipment:	Optional Equipment:
<ul style="list-style-type: none"> ▪ 115 horse power slip clutch ▪ Highway speed rated 275/60R15 tires ▪ Hydraulic adjustable side deflectors ▪ Clearance lights 	<ul style="list-style-type: none"> ▪ Hydraulic drive Spin Spreader ▪ Side deflector expansions ▪ 3PT quick hitch

Model #	Description	MSRP [CDN]
300705	Recon 300- Pulltype, 7 ft rolls with 540 RPM PTO	\$33,400.00
300701	Recon 300- Pulltype, 7 ft rolls with 1000 RPM PTO	\$33,400.00
300901	Recon 300- Pulltype, 9 ft rolls with 1000 RPM PTO	\$38,850.00

Options

Part #	Description	MSRP [CDN]
321645	Spin Spreader Kit , 7 foot kit	\$4,600.00
321250	Spin Spreader Kit , 9 foot kit	\$5,500.00
321585	Tandem Wheel Option	\$2,200.00
	Factory Set-Up – Tow Configuration	\$900.00

No Freight Charges on Options Ordered With Machine. Contact HARCO for Shipping Charges on Options Ordered Later.



PRICED IN CANADIAN DOLLARS

PRICES ARE FOB BENITO, MB – DESIGN & PRICE ARE SUBJECT TO CHANGE WITHOUT NOTICE



5808 Hwy #9, Harriston, Ontario, N0G 1Z0
Phone: 519-338-2923, Fax: 519-338-2756
Email: sales@harcoag.ca
www.harcoag.ca

Date Change Only

Cross Augers for Draper Headers

Standard Features Include:

- Patented Angled Stripper deflector bar
- Swept Back Unloader Paddle
- Variable speed motor control
- FlexEnd Technology for flex drapers

Part #	Description	MSRP [CDN]
For Rigid Framed Draper Headers		
Various	Under 24' Cross Auger kit	\$6,100.00
Various	25' Cross Auger kit	\$6,600.00
Various	30' Cross Auger kit	\$7,250.00
Various	35'-36' Cross Auger kit	\$7,500.00
Various	40' Cross Auger kit	\$7,800.00
Various	45' Cross Auger kit	\$8,100.00
Various	50' Cross Auger kit	\$8,500.00
For Hinged Flex Draper Headers		
Various	30' Cross Auger kit for Macdon FD	\$7,350.00
Various	35/36' Cross Auger kit for Macdon FD, Deere HDT/F	\$7,800.00
Various	40' Cross Auger kit for Macdon FD, Deere HDR/F, Gerringhoff	\$8,000.00
Various	45' Cross Auger kit for Macdon FD, Deere HDR/F, Gerringhoff	\$8,400.00
Various	50' Cross Auger kit for Macdon FD, Deere HDR/F, Gerringhoff	\$8,800.00
	Stripper Bar Kit	\$1,800.00
	ONLY APPLICABLE IN WESTERN CANADA. Auger exchange kits available for worn out Macdon Augers, up to \$1,500.00 core credit available per straight auger (\$3,000.00 kit)	
Freight charges vary dependant on quantity ordered		

PRICED IN CANADIAN DOLLARS

PRICES ARE FOB BENITO, MB – DESIGN & PRICE ARE SUBJECT TO CHANGE WITHOUT NOTICE

5808 Hwy #9, Harriston, Ontario, N0G 1Z0
Phone: 519-338-2923, Fax: 519-338-2756
Email: sales@harcoag.ca
www.harcoag.ca



AG SHIELD



Date Change Only

Cross Augers for Draper Headers – Part Number Reference Table

Header	Width	Part #	Header	Width	Part #
AGCO / MF			John Deere		
9345 AGCO	45ft	4159345	HD35R / HD35F	35ft	413035
9340 AGCO	40ft	4159340	HD40R / HD40F	40ft	413040
9335 AGCO	35ft	4159335	HD45R / HD45F	45ft	413045
9330 AGCO	30ft	4159330	HD50R / HD50F	50ft	413050
9250 / 9255 Dynaflex	45ft	406504	645FD / 745FD / RD45F	45ft	405853
9250 / 9255 Dynaflex	40ft	406503	640FD / 740FD / RD40F	40ft	405852
9250 / 9255 Dynaflex	35ft	406502	635FD / 735FD / RD35F	35ft	405851
9250 / 9255 Dynaflex	30ft	406501	630FD / 730FD / RD30F	30ft	405850
9250 / 9255 Dynaflex	25ft	406500	640D/740D	40ft	405848
5300 / 5400 AGCO	40ft	405863	635D/735D	35ft	405847
5300 / 5400 AGCO	35ft	405862	630D/730D	30ft	405846
5300 / 5400 AGCO	30ft	405861	625D/725D	25ft	405845
5300 / 5400 AGCO	25ft	405860	936D	36ft	405844
5000 - 5200 AGCO	36ft	405797	930D	30ft	405843
5000 - 5200 AGCO	30ft	405796	925D	25ft	405842
5000 - 5200 AGCO	25ft	405795	440 Swather (D65)	40ft	405867
600 AGCO	36ft	405828	2360 Swather	18ft	405840
600 AGCO	30ft	405827	MacDon		
Honey Bee			960 Finger Forward	25ft	405870
Honey Bee AirFlex	30ft	412230	960 Finger Forward	30ft	405871
Honey Bee AirFlex	36ft	412236	960 Dual Drive	36ft	405885
Honey Bee AirFlex	40ft	412240	962 (CNH 1042)	25ft	405880
Honey Bee AirFlex	45ft	412245	962 / 963 (CNH 1042 / 2042)	30ft	405824
Honey Bee AirFlex	50ft	412250	962 / 963 (CNH 1042 / 2042)	36ft	405826
Honey Bee	42ft	405812	972 / 973 (CNH 1052 / 2052)	15ft	405874
Honey Bee NH94C	40ft	405810	972 / 973 (CNH 1052 / 2052)	18ft	405930
Honey Bee	39ft	405811	972 / 973 (CNH 1052 / 2052)	21ft	405875
Honey Bee (Ctr) NH94C	36ft	405803	972 / 973 (CNH 1052 / 2052)	25ft	405876
Honey Bee (Offset)	36ft	405806	972 / 973 (CNH 1052 / 2052)	30ft	405877
Honey Bee, NH94C	30ft	405802	972 / 973 (CNH 1052 / 2052)	36ft	405878
Honey Bee	25ft	405800	974 (CNH 2062, NH84C)	30ft	410029
CNH			974 (CNH 2062, NH84C)	36ft	410036
NH 840CD, 880CF, CNH 3142, 3152, 3162	45ft	406499	D60 / D65 / D145 (CNH 2142, 2152)	45ft	405873
NH 840CD, 880CF, CNH 3142, 3152, 3162	40ft	406498	D60 / D65 / D140 (CNH 2142, 2152)	40ft	405867
NH 840CD, 880CF, CNH 3142, 3152, 3162	35ft	406497	D60 / D65 / D135 (CNH 2142, 2152)	35ft	405866
NH 840CD, 880CF, CNH 3142, 3152, 3162	30ft	406496	D60 / D65 / D130 (CNH 2142, 2152)	30ft	405865
NH 840CD, 880CF, CNH 3142, 3152, 3162	25ft	406495	D60 / D65 / D125 (CNH 2142, 2152)	25ft	405864
Midwest			FD70 / FD75 / FD145 (CNH 2162)	45ft	410045
Midwest	45ft	405836	FD70 / FD75 / FD140 (CNH 2162)	40ft	410040
Midwest	42ft	405835	FD70 / FD75 / FD135 (CNH 2162)	35ft	410035
Midwest	40ft	405834	FD70 / FD75 / FD130 (CNH 2162)	30ft	410030
Midwest	36ft	405833	FD250	50ft	420050
CLAAS			FD245	45ft	420045
MaxFlo 1050	35ft	411050	FD240, Triple Reel	40ft	420040
MaxFlo 1200	40ft	411200	FD241, Dual Reel	40ft	420041
Convio 1080	35ft	411080	FD235	35ft	420035
Convio 1230	40ft	411230			
Convio 1380	45ft	411380			

PRICED IN CANADIAN DOLLARS

PRICES ARE FOB BENITO, MB – DESIGN & PRICE ARE SUBJECT TO CHANGE WITHOUT NOTICE



Date Change Only

Sprayers ATV & Side by Side

- Features Include:**
- Ideal for drift reduction and reducing off target drift & subsequent damage in adjacent property.
 - Useful for livestock operation in fence lines & patch treatment in pastures.
 - Municipalities can control unwanted vegetation in ditches, boulevards & ditches.
- Standard Equipment:**
- Follows the ground with wheels that are included to ensure best wind protection.
 - Includes a 15-60 US gallon V bottom tank, a high capacity 12V pump with relief valve.
 - Shutoff valves for each boom section.
- Optional Equipment:**
- 5, 10 & 15' standard units available, ask about special orders.
 - Hand wand with hose reel.
 - Fresh water or second chemical tank.
 - Chemical Inductor.

Model #	Description	MSRP [CDN]
235400	Complete 10' Shielded Sprayer, 12 gal tank, ATV receiver mounts	\$3,920.00
235481	Complete 15' Shielded Sprayer, 50 gal tank, UTV box mount	\$6,020.00
235399	Complete 15' Shielded Sprayer, 50 gal tank, 3 PT hitch mount	\$5,670.00
235645	Shielded Boom section, 5' centre, 3 way rollover nozzles	\$965.00
235640	Shielded Boom section, 5' left, 3 way rollover nozzles	\$965.00
235635	Shielded Boom section, 5' right, 3 way rollover nozzles	\$965.00
231790	Premium hand want, 50' hose on manual reel with ball valve	\$1,150.00
237751	Chemical Inductor	\$125.00
235482	Electric remote control for boom shut-offs	\$700.00
231709	LH or RH end nozzle kit (not shielded)	\$454.00
235840	Eye and hand wash fresh water kit, 12 gallon	\$460.00
115340	Trimble GFX350 with Nav 500	\$3,499.00
	Factory set up or installation	\$400.00



PRICED IN CANADIAN DOLLARS

PRICES ARE FOB BENITO, MB – DESIGN & PRICE ARE SUBJECT TO CHANGE WITHOUT NOTICE



Date Change Only

Sprayers

Truck Mounted Road Side

Features Include:

- Ideal for drift reduction and reducing off target drift & subsequent damage in adjacent property.
- Municipalities can control unwanted vegetation in ditches, boulevards & ditches.

Standard Equipment:

- Shielded sprayer with gauge wheels follow the ground to insure best drift protection.
- High capacity Honda pump.
- Shutoff valves for each boom section.
- Auto reset boom breakaway.

Optional Equipment:

- 7, 12 & 17' standard units available, ask about special orders
- Hand wand with hose reel, 425-510 US gallon V bottom fill tank
- Fresh water, second or third chemical tank
- Upper or lower end nozzles. Eye & hand wash kit. Firefighter nozzle, Microtrak autorate controller

Model #	Description		MSRP [CDN]
231815	Base	Road Side Sprayer, w Honda pump & microtrak autorate controller	\$8,665.00
231816	Base	Road Side Sprayer, w Honda pump & manual pressure control	\$6,050.00
231850	Booms	S18 Shielded Sprayer Boom, 7' 4 nozzle centre w/Varitarget	\$6,100.00
231853	Booms	S18 Shielded Sprayer Boom, 5' 3 nozzle left w/Varitarget	\$4,300.00
231858	Booms	S18 Shielded Sprayer Boom, 5' 3 nozzle right w/Varitarget	\$4,300.00
231810	Booms	Shielded Sprayer Boom, 7' 4 nozzle right w/Varitarget	\$5,070.00
231701	Tanks	425 gallon tank for 5 ½' truck bed	\$5,075.00
231700	Tanks	510 gallon tank for 6 ½" truck bed	\$5,375.00
231702	Tanks	Dual 510 gallon tanks for trucks with deck	\$7,170.00
231695	Tanks	Dual 60 gallon optional tanks for 8' truck bed	\$2,050.00
		OPTIONS	
231709		Lower end nozzle kit, not shielded	\$445.00
231708		Upper end nozzle kit, not shielded	\$445.00
116222		Firehose nozzle kit, 12' hose with manual shut off	\$500.00
231790		Hand wand kit, 100' hose on manual rewind reel	\$1,750.00
231686		Premium hand wand kit, 100' hose on 12VDC electric rewind reel	\$2,950.00
231681		LED Beacon light kit, 360 degree view	\$350.00
		Colour monitor and camera for RH boom view	\$900.00
235840		Eye & hand wash fresh water kit, 12 gallon	\$460.00
		Factory set up or installation	\$900.00



PRICED IN CANADIAN DOLLARS

PRICES ARE FOB BENITO, MB – DESIGN & PRICE ARE SUBJECT TO CHANGE WITHOUT NOTICE



Date Change Only

Sprayers

Cat II 3 Point Hitch Road Side

- Features Include:**
- Ideal for drift reduction and reducing off target drift & subsequent damage in adjacent property.
 - Municipalities can control unwanted vegetation in ditches, boulevards & ditches.
- Standard Equipment:**
- Shielded sprayer with gauge wheels follow the ground to insure best drift protection.
 - 60 US gallon V bottom fill tank with high capacity hydraulic pump.
 - Shutoff valves for each boom section.
 - Auto reset boom breakaway.
- Optional Equipment:**
- 7, 12 & 17' standard units available, ask about special orders
 - Hand wand with hose reel
 - Fresh water, second or third chemical tank
 - Upper or lower end nozzles. Eye & hand wash kit. Firefighter nozzle, Microtrak autorate controller

Model #	Description		MSRP [CDN]
235975	Plumbing	Road Side Sprayer, w Hydraulic pump & microtrak autorate controller	\$8,665.00
235976	Plumbing	Road Side Sprayer, w Hydraulic pump & manual pressure control	\$6,050.00
231850	Booms	S18 Shielded Sprayer Boom, 7' 4 nozzle centre w/Varitarget	\$6,100.00
231853	Booms	S18 Shielded Sprayer Boom, 5' 3 nozzle left w/Varitarget	\$4,300.00
231858	Booms	S18 Shielded Sprayer Boom, 5' 3 nozzle right w/Varitarget	\$4,300.00
231810	Booms	Shielded Sprayer Boom, 7' 4 nozzle right w/Varitarget	\$5,070.00
235960	Base	60 gallon tank for 3 point hitch	\$5,250.00
235961	Base	Dual 60 gallon tanks for 3 point hitch	\$6,300.00
		OPTIONS	
231709		Lower end nozzle kit, not shielded	\$445.00
231708		Upper end nozzle kit, not shielded	\$445.00
116222		Firehose nozzle kit, 12' hose with manual shut off	\$500.00
231790		Hand wand kit, 100' hose on manual rewind reel	\$1,750.00
231686		Premium hand wand kit, 100' hose on 12VDC electric rewind reel	\$2,950.00
231681		LED Beacon light kit, 360 degree view	\$350.00
		Colour monitor and camera for RH boom view	\$900.00
235840		Eye & hand wash fresh water kit, 12 gallon	\$460.00
		Factory set up or installation	\$900.00



PRICED IN CANADIAN DOLLARS

PRICES ARE FOB BENITO, MB – DESIGN & PRICE ARE SUBJECT TO CHANGE WITHOUT NOTICE



5808 Hwy #9, Harriston, Ontario, N0G 1Z0
Phone: 519-338-2923, Fax: 519-338-2756
Email: sales@harcoag.ca
www.harcoag.ca

Date Change
Call for prices

Multi Trailer

Hay Hauling System – Sold Factory Direct

Features Include:

- Manual electric brake interlock for loading
- Conversion from flat deck to bale mode in under a minute with one person

Standard Equipment:

- 8000 lb axles, trailer ramps
- 14 ply – load range ‘G’ tires, LED lights

Optional Equipment:

- 2 5/16” Ezee guide ball hitch
- King Pin Hitch

Model #	Description	MSRP [CDN]
450660	Multi-Trailer – 31’, Tri-Axle Hay Hauling System	
Replacement Parts		
450398	Kingpin Hitch	
450476	2 5/16” Ball Ezee Guide Hitch	
113984	14 Ply Spare Tire w/Rim	
450890	Rear Flashing Amber Light	
	Please contact Harco for current freight quote	



PRICED IN CANADIAN DOLLARS

PRICES ARE FOB BENITO, MB – DESIGN & PRICE ARE SUBJECT TO CHANGE WITHOUT NOTICE



Sitrex Mowers

Disc Mower – Series DM					
Code	Model	Weight		Net Set Up	Price [CDN]
		Lb	Kg		
801.281	DM/4 4 Disc Mower – 66” Cutting Width	700	320	\$100.00	\$14,277.00
801.282	DM/5 5 Disc Mower – 81” Cutting Width	810	370	\$100.00	\$15,620.00
801.311	*DM/6-S 6 Disc Mower – 95” Cutting Width	910	420	\$120.00	\$20,320.00
801.310	*DM/7-S 7 Disc Mower – 110” Cutting Width	1,080	490	\$120.00	\$21,502.00
801.322	*DM/8-S 8 Disc Mower – 127” Cutting Width	1,400	635	\$120.00	\$27,195.00

**The DM S series mowers (6, 7, 8 discs) have a different, more robust frame structure and drives for more professional uses.*



PRICED IN CANADIAN DOLLARS

PRICES ARE FOB HARRISTON, ON- DESIGN & PRICE ARE SUBJECT TO CHANGE WITHOUT NOTICE

5808 Hwy #9, Harriston, Ontario, N0G 1Z0
Phone: 519-338-2923 Fax: 519-338-2756
Email: sales@harcoag.ca / www.harcoag.ca

Sitrex Hay Rakes, Tedders, Bale Wrappers & Balers

Code	Model	Weight		Net Set Up	Price [CDN]
		Lb	Kg		
3-Point Type – RP Series					
802.036	RP/2 RH	145	66	\$60.00	\$ 1,332.00
802.037	RP/3			\$90.00	\$ 1,905.00
802.010	RP/4 RH	396	180	\$120.00	\$ 2,517.00
802.012	RP/5 RH Wheel on end	440	200	\$150.00	\$ 3,026.00
802.017	RP/6 RH	551	250	\$180.00	\$ 3,893.00
QR Series V-Rake with Suspension					
802.352	QR-8, 8 Wheel, 10' Working Width	1500		\$250.00	\$ 12,496.00
802.353	QR-10, 10 Wheel, 22' Working Width	1630		\$315.00	\$ 14,066.00
802.354	QR-12, 12 Wheel, 25' 7" Working Width	1830		\$380.00	\$ 16,011.00
230.371/c	QR Centre Kicker Wheel				\$ 1,465.00
230.735	QR HYDR. ADJ. KIT QR8-10				\$ 2,035.00
230.736	QR HYDR. ADJ. KIT QR8-12				\$ 2,075.00
230.908	CONVERSION KIT FOR QR/8 IN QR/10				\$ 2,035.00
QRX Series V-Rake					
802.930	QRX-12, 12 Wheel, 55" x 7mm Tines	2670	1210	\$420.00	\$ 21,802.00
802.931	QRX-14, 14 wheel, 55" x 7mm Tines	2955	1340	\$480.00	\$ 23,594.00
802.934	QRX-16, 16 wheel, 55" x 7mm Tines	3616	1640	\$600.00	\$ 28,533.00
802.932	QRX-12, 12 wheel, 60" x 7.5mm Tines	2955	1340	\$420.00	\$ 22,392.00
802.933	QRX-14, 14 wheel, 60" x 7.5mm Tines	3330	1510	\$480.00	\$ 24,288.00
802.935	QRX-16, 16 wheel, 60" x 7.5mm Tines	3616	1640	\$600.00	\$ 29,325.00
260.698	Dual Kicker Wheel Kit				\$ 2,240.00
Basket Rakes					
802.895	BR2030/6				\$ 87,220.00
802.891	BR2030/7				\$ 88,431.00
HEAVY DUTY RAKES					
802.740	PRO/17 RAKE (17 wheels)				\$ 64,430.00

PRICED IN CANADIAN DOLLARS

PRICES ARE FOB HARRISTON, ON - DESIGN + PRICE ARE SUBJECT TO CHANGE WITHOUT NOTICE

5808 Hwy #9, Harriston, Ontario, N0G 1Z0
 Phone: 519-338-2923 Fax: 519-338-2756
 Email: sales@harcoag.ca / www.harcoag.ca

File Section: 3, Page 47
 Effective January 1, 2026

Code	Model	Weight		Net Set Up	Price [CDN]
		Lb	Kg		
MX Explorer Rakes – Pull Type					
802.030	MX/8 Less Ratchet Jack	2685	1220	\$320.00	\$ 21,701.00
802.016	MX/10 Less Ratchet Jack	3015	1370	\$400.00	\$ 23,169.00
802.158	MX/12 With Ratchet Jack	3350	1520	\$480.00	\$ 24,970.00
Optional					
220.264	Ratchet Jack Kit				\$ 867.00
220.379	Hydraulic Kicker Wheel Kit				\$ 2,624.00
220.434	Single Side Opening Kit				\$ 1,722.00
220.441	Conversion Kit – MX8-10				\$ 1,722.00
Tedders					
802.739	RT/3000 Pull Type	385	175		\$ 5,260.00
802.747	RT/5200 17' Spring Lift Pull Type				\$ 10,684.00
802.746	RT/5200 H 17' Hydraulic Lift Pull Type	830	377		\$ 11,459.00
802.788	RT/5800 19' Hydraulic Lift – Pull Type				\$ 12,820.00
802.015	ST/780H Six Rotors, Hydraulic 26' Pull	2470	1120		\$ 33,666.00
Tedders – Rakes					
802.129	Hay Maker 300	726	330		\$ 8,786.00
802.091	Hay Maker 400	924	420		\$ 13,155.00
<i>Including PTO Shaft</i>					
MKE Professional Rakes – Pull Type, New Style					
802.918	MKE/10, 10 Wheel, 55" x 7mm Tines	3920	1780	\$400.00	\$ 29,452.00
802.919	MKE/12, 12 Wheel, 55" x 7mm Tines	4275	1940	\$480.00	\$ 30,935.00
802.920	MKE/14, 14 Wheel, 55" x 7mm Tines	5615	2550	\$560.00	\$ 40,815.00
802.921	MKE/16, 16 Wheel, 55" x 7mm Tines	6060	2750	\$640.00	\$ 42,312.00
802.922	MKE/18, 18 Wheel, 55" x 7mm Tines	7465	3385	\$720.00	\$ 49,699.00
802.923	MKE/20, 20 Wheel, 55" x 7mm Tines	7760	3520	\$800.00	\$ 51,193.00
<i>MKE Series Rakes – 60" x 7.5mm Wheel Option</i>					

PRICED IN CANADIAN DOLLARS

PRICES ARE FOB HARRISTON, ON - DESIGN + PRICE ARE SUBJECT TO CHANGE WITHOUT NOTICE

5808 Hwy #9, Harriston, Ontario, N0G 1Z0
 Phone: 519-338-2923 Fax: 519-338-2756
 Email: sales@harcoag.ca / www.harcoag.ca

File Section: 3, Page 47a
 Effective January 1, 2026

Code	Model	Weight		Net Set Up	Price [CDN]
		Lb	Kg		
MKE Professional Rakes Continued					
Optional					
250.462/b	Hydraulic Kicker Wheel Kit				\$ 3,326.00
250.441	Tandem Tire/Wheel Kit				\$ 2,480.00
250.443	Rear Hydraulic Opening Kit – MKE10-12				\$ 3,000.00
250.444	Rear Hydraulic Opening Kit – MKE14-16				\$ 3,049.00
250.492	Rear Hydraulic Opening Kit – MKE18-20				\$ 3,139.00
250.436	Conversion Kit – MKE10-12, 55" Wheels				\$ 1,500.00
250.437	Conversion Kit – MKE14-16, 55" Wheels				\$ 2,072.00
250.437	Conversion Kit – MKE18-20, 55" Wheels				\$ 2,072.00
250.438	Conversion Kit, MKE10-12, 60" Wheels				\$ 1,592.00
250.439	Conversion Kit, MKE14-16, 60" Wheels				\$ 2,165.00
250.439	Conversion Kit, MKE18-20, 60" Wheels				\$ 2,165.00
250.445	Single Side Opening Kit				\$ 1,740.00
Rotary Rakes					
802.081	SR320/8, 3-Point, 8 Arms				\$ 10,236.00
802.599	SR350/9, 3-Point, 9 Arms	991	450	\$150.00	\$ 12,846.00
812.014	SR420/11, 3-Point, 11 Arms	1233	560	\$200.00	\$ 16,196.00
802.063	SR420/11H Pull-Type	1352	614	\$200.00	\$ 20,782.00
802.321	SR500/13, 3-Point, 13 Arm	1907	865	\$300.00	\$ 19,970.00
802.729	SR500/13, Pull-Type w/ Tandem, 13 Arms	1907	865	\$300.00	\$ 22,444.00
812.024	TW7800 Twin Rotary Rake	4140	1880		\$ 52,266.00

PRICED IN CANADIAN DOLLARS

PRICES ARE FOB HARRISTON, ON - DESIGN + PRICE ARE SUBJECT TO CHANGE WITHOUT NOTICE

5808 Hwy #9, Harriston, Ontario, N0G 1Z0
 Phone: 519-338-2923 Fax: 519-338-2756
 Email: sales@harcoag.ca / www.harcoag.ca

File Section: 3, Page 47b
 Effective January 1, 2026

Sitrex Bale Wrappers & Balers

Code	Model	Weight		Net Set Up	Price [CDN]
		Lb	Kg		
Baler Wrappers					
802.295	WR/1600 Standard 3 PT				\$ 41,321.00
802.296	WR/1800 Standard 3 PT				\$ 28,472.00
802.299	WR/3100 Standard Pull Type				\$ 37,628.00
802.301	WR/5100 Standard Pull Type				\$ 48,517.00
802.542	WR/1600-A with Automatic Wrapping-3 PT				\$ 47,884.00
802.494	WR/1800-A with Automatic Wrapping-3 PT				\$ 38,174.00
802.545	WR/3100-A with Automatic Wrapping-Pull Type				\$ 45,038.00
802.546	WR/5100-A with Automatic Wrapping-Pull Type				\$ 58,144.00
Optional					
240.197	Overturning vertical bale kit WR3100				\$ 3,104.00
Balers					
808.009	M50 Mini Round Baler				\$ 31,351.00
808.011	M60 Mini Square Baler				\$ 32,654.00
808.012	M60 Super Square Baler IN STOCK	Holding 2025 price of \$33,553.00			\$ 33,729.00
808.013	M61 Export/160 Square Baler				\$ 38,842.00
808.014	M61 Export/170 Square Baler				\$ 41,521.00

PRICED IN CANADIAN DOLLARS

PRICES ARE FOB HARRISTON, ON - DESIGN + PRICE ARE SUBJECT TO CHANGE WITHOUT NOTICE

DARF Rakes

7-Bar Hydraulic Basket Rake				
Model	Description	Weight (lbs)	Assembly	Price [USD]
6707CG	Fully Hydraulic, 31', Clevis Hitch	6250		\$48,999.00

Super Duty 17-Wheel Overhead Rakes				
1017LAC	Manual, 24'	5450	\$800.00	\$44,725.00
1017LWAC	Manual, Wide, 29'	5705	\$800.00	\$46,610.00
1017LFMAC	Hydraulic, 24'	5450	\$950.00	\$48,270.00
1017LFMWAC	Hydraulic, Wide, 29'	5750	\$950.00	\$50,975.00
1017LFMWGC	Hydraulic, Wide, GSNCK, 29'	5905	\$950.00	\$52,015.00

3-Point Mount 15 Wheel Rake				
915BRP	Manual, 22'	2740	\$600.00	\$28,450.00

3 & 4 Wheel Front Mounted Turning Rakes				
903BRHP	Manual, 65"	975	\$125.00	\$5,095.00
904BRHP	Manual, 81"	1075	\$125.00	\$6,325.00

3 & 4 Wheel Rear Mounted Turning Rakes				
943BRP	Manual, 65"	560	\$175.00	\$6,425.00
944BRP	Manual, 81"	670	\$175.00	\$7,645.00

5 & 8 Wheel Tow Behind Turning Rakes				
905TGBRP	Manual, 8'	1425	\$200.00	\$14,095.00
908TGBRP	Manual, 12'	1875	\$225.00	\$19,995.00

10-Wheel 3-Point Mount Brush Rake				
510	Manual, 20'	1700	\$350.00	\$13,350.00

TIRES ARE ADDITIONAL – LIST PRICES		
Part Number	Description	Price [USD]
FC715KIT	7.62-15SL-8 Tires	PER KIT \$1,565.00
SG11LX15-M	11L-15SL-8 Tires	PER KIT \$1,975.00

PRICED IN UNITED STATES DOLLARS

PRICES ARE FOB SHAFTER, CA IN U.S.D. – SUBJECT TO CHANGE WITHOUT NOTICE

DARF Rakes – Model Descriptions

Model	Descriptions
6707CG	7-BAR HYDRAULIC RAKE with super duty walking beam axle with 2" spindles, 6" wheels, rubber mounted universal tines. An eight function electric/hydraulic manifold and control box including adjustable basket speed. 33 1/2" drive & idler wheels made from 3/8" steel with gauge wheels' front and rear. Requires two hydraulic circuits on prime mover. Specify 2-5/16" ball hitch or clevis hitch.
1017LAC	17-WHEEL OVERHEAD RAKE with super duty walking beam axle with 2" spindles, 8" wheels, heavy duty hubs, taper bearings in rake wheel cranks, rubber mounted double tines & dur-adjust. Requires two hydraulic circuits on prime mover. Specify 2-5/16" ball hitch or clevis hitch.
1017LWAC	17-WHEEL OVERHEAD RAKE with heavy duty overhead, 5' rephrasing cylinders, super duty walking beam axles mounted with 2" spindles, 8" wheels heavy duty hubs, taper bearings in rake wheel cranks, rubber mounted double tines & dur-adjust. Requires 2 hydraulic circuits on prime mover. Specify 2-5/16" ball hitch or clevis hitch.
1017LFMAC	17-WHEEL OVERHEAD RAKE with Fasse 7-function electro/hydraulic control valve (operate all functions from the Operator Platform). Equipped with super duty walking beam axle mounted with 2" spindles, 8" wheels, heavy duty hub, taper bearings in rake wheel cranks, rubber mounted double tines & dur-adjust. Requires one hydraulic circuit & 12 volt access for control panel. Specify 2-5/16" ball hitch or clevis hitch.
1017LFMWAC	17-WHEEL OVERHEAD RAKE with heavy duty overhead, 5' rephrasing cylinders, super duty walking beam axles mounted with 2" spindles, heavy duty hubs, 8" wheels, rubber mounted double tines, dur-adjust and Fasse 7-function electro/hydraulic control valve (operate all functions from Operator Platform). Requires one hydraulic circuit and 12 volt access for control panel. Specify 2-5/16" ball hitch or clevis hitch.
1017LFMWGC	17-WHEEL OVERHEAD RAKE (same as above) EXCEPT WITH A GOOSENECK DRAW BAR.
915BRP	15-WHEEL, 3-POINT MOUNTED RAKE equipped with taper bearings in rake wheel cranks, and rubber mounted double tines.
903BRHP 904BRHP	3 OR 4 WHEEL WINDROW TURNER; FRONT MOUNTED, equipped with taper bearings in rake wheel cranks and rubber mounted double tines.
943BRHP 944BRHP	3 OR 4 WHEEL WINDROW TURNER; REAR MOUNTED, equipped with taper bearings in rake wheel cranks and rubber mounted double tines.
905TGBRP 908TGBRP	5 OR 8 WHEEL WINDROW TURNER; TOW BEHIND, equipped with taper bearings in rake wheel cranks and rubber mounted double tines. Requires one hydraulic circuit. Specify Right or Left Models and 2-5/16" ball hitch or clevis hitch.
510	10-WHEEL 3-POINT MOUNTED BRUSH RAKE equipped with taper bearings in rake wheel cranks, heavy duty double rake wheel frames and solid steel wheel covers. Raking Frames feature removeable segments. Can be used in 6, 8 or 10 wheel configurations for different row spacing. Requires two hydraulic circuits.

PRICED IN UNITED STATES DOLLARS

PRICES ARE FOB SHAFTER, CA IN U.S.D. – SUBJECT TO CHANGE WITHOUT NOTICE

Accessories & Conversions

Part #	Description	Price [USD]
KSC917FS	Cable Track Conversion Kit – 917F Standard	CALL
KSC917FW	Cable Track Conversion Kit – 917F Wide	CALL
KSC917S	Cable Track Conversion Kit –917 Standard	CALL
KSC917W	Cable Track Conversion Kit – 917 Wide	CALL
SRKIT2-17	Dur-Adjust Kit for 17 Wheel Overhead Rake	\$3,900.00
H7000806	Fasse Conversion Kit for 917 Standard Includes: Hoses, Fittings, Control Panel, Valve Body, Swing Cylinders, Cable Track & Mounting Brackets	\$8,540.00
H7000806A	Fasse Conversion Kit for 917 Wide Includes: Hoses, Fittings, Control Panel, Valve Body, Swing Cylinders, Cable Track & Mounting Brackets	\$6,145.00
101793FLAC / 101793FRAC	Add a Wheel – Front – Kit with Crank, Spring & Rod with a Complete Rake Wheel (Left or Right)	\$1,945.00
101792RLAC / 101793RRAC	Add a Wheel – Rear – Kit with Crank, Spring & Chain with a Complete Rake Wheel (Left or Right)	\$1,145.00
9080301	Retrofit with 4910# Hub – Complete Heavy Duty Walking Beam – Includes: Heavy Duty Hubs, Spindles, without Wheels One Rake to Convert from Standard Walking Beam or Fixed Axle. Both Sides	CALL
1180301	Retrofit with Complete Super Duty Walking Beam – Includes: Super Duty Hubs, Spindles, without Wheels, Convert from Any Beam or Fixed Axle. Both Sides.	CALL
162000	Gooseneck Assembly for 1017 Rake, Field Install	\$7,570.00
GNK003	Kicker Assembly, for Gooseneck Tongue, 3 Rake Wheels Complete with Spring & Rod	\$4,740.00
102114	Heavy Duty Rake Wheel Frame	\$300.00
10211400P	Heavy Duty Rake Wheel Assembled with Poly Shield & Teeth (Included, but Not Attached)	\$679.00
HDRW17-KIT	Heavy Duty Rake wheel Kit, Sold with Wholegoods	\$1,815.00

Net Charge for Complete Factory Assembly (No Discounts)

Unit is ready for delivery to your customer:

2 thru 4 Wheel Standard Units	\$635.00 NET
5 thru 6 Wheel Standard Units	\$715.00 NET
8 Wheel Standard Units	\$850.00 NET
13 thru 17 Wheel Standard Units	\$1,475.00 NET
All Fully Hydraulic Control Units	\$1,825.00 NET
***Partial Assembly 17 Wheel Units	\$690.00 NET

PRICED IN UNITED STATES DOLLARS

PRICES ARE FOB SHAFTER, CA IN U.S.D. – SUBJECT TO CHANGE WITHOUT NOTICE



Ferri is a leading international manufacturing company of boom mowers for grounds maintenance, slopes, river banks, and hedges. Flail Mowers and shredders for large and small excavators are available as well.

In addition to wholegoods and parts stocked by HARCO, the company supports North American after sale service, warranty and spare parts with a company warehouse in Massachusetts.

Due to the extensive line of models and options available the following price list gives base product prices only in USD (United States Dollars). For complete catalogue information (39 pages) contact your Harco Territory Manager, our sales desk at Harriston, or www.ferri-america.com.

Model	Width of Cut	Slope or Fixed	Max. Capacity	Weight (lbs)	Price (CAD)
3-Point Mowers					
ZME 155	5' 1"	Slope	1" Y-Blade	575	\$15,742.00
ZMGE 1600	5' 4"	Slope	1 3/4" Hammer	1025	\$17,755.00
ZMTE PRO 1600	5' 4"	Slope	1 3/4" Hammer	1336	\$23,086.00
ZMTE PRO 1800	6' 1/2"	Slope	1 3/4" Hammer	1,398	\$23,669.00
ZMTE PRO 2000	6' 8"	Slope	1 3/4" Hammer	1444	\$23,910.00
ZMTE PRO 2300	7' 5"	Slope	1 3/4" Hammer	1556	\$24,756.00
*ZLE PRO 2000	6' 8"	Slope	1 3/4" Hammer	1896	\$28,170.00
ZHE 2500	8' 3"	Slope	1 3/4" Hammer	2998	\$36,017.00

Boom Hedger					
Model	Width of Cut	Max. Horizontal Reach	Max. Capacity	Weight (lbs)	Price (CAD)
T350 SI	4' 11"	11' 11"	1/2"	810	\$21,226.00
Boom Mowers					
<i>Prices include Delta yoke, stabilizer and oil cooler option where applicable</i>					
T250A Classic	24"	8' 3"	3/4" Y-Blades	749	\$26,186.00
T320A Classic	31"	10' 7"	3/4" Y-Blades	816	\$27,147.00
<i>Above Models Available with Electric Joystick – Please Call</i>					
T380D Smart-Classic	39"	12' 7"	1 1/4" Y-Blades	1080	\$29,264.00
T430 DR	39"	14' 2"	1 1/4" Y-Blades	1091	\$32,685.00
<i>Above Models Available with Electric Joystick – Please Call</i>					
TP600 Classic	47"	19' 6"	1 3/4" T-Hammer	2094	\$49,592.00
<i>Above Models Available with Electric Joystick – Please Call</i>					

**These prices are only good for Ferri units that we have in stock.
 For all other units, please use the Ferri Sales Book dated 2025/2026
 found on our website. Thank You.**

PRICED IN CANADIAN DOLLARS

FOB HARRISTON, ON – DESIGN & PRICE ARE SUBJECT TO CHANGE WITHOUT NOTICE

5808 Hwy #9, Harriston, Ontario, N0G 1Z0
Phone: 519-338-2923, Fax: 519-338-2756
Email: sales@harcoag.ca
www.harcoag.ca



DEL MORINO FLAIL MOWERS

ENGINE DRIVEN

CENTURION ATV	Standard Features
 <p><i>Designed to be towed by a Quad, Rider or ATV. It can cut & mulch grass, weeds & shrubs, clear uncultivated fields.</i></p>	<p>NEW</p> <ul style="list-style-type: none"> ▪ 2" Ball Type Coupling ▪ Honda GX390 Engine/Loncin 420 ▪ 2 belt drive transmission w/screw adjustable tensioner ▪ Rotor w/blades or hammers ▪ Adjustable rear roller ▪ Mechanic side shift 56 cm ▪ Centrifugal clutch/fuel tank 6L. ▪ Wheel position adjustable ▪ Pull Start

Model #	Working Width	Engine HP	Wt (lbs)	Price (Cdn)
ATV132 – Honda	52"	13	650	\$5,885.00

CENTURION ATV PRO	Standard Features
 <p><i>Designed to be towed by a Quad, Rider or ATV. It can cut & mulch grass, weeds & shrubs, clear uncultivated fields.</i></p>	<p>NEW</p> <ul style="list-style-type: none"> ▪ 2" Ball Type Coupling ▪ Honda IGX800 Engine ▪ 2 belt drive transmission w/screw adjustable tensioner ▪ Rotor w/blades or hammers ▪ Adjustable rear roller ▪ Mechanic side shift 56 cm ▪ Centrifugal clutch/fuel tank 11L. ▪ Wheel position adjustable ▪ Electric Start//Battery Included

Model #	Working Width	Engine HP	Wt (lbs)	Price (Cdn)
ATV158 PRO Honda	62"	25	794	\$9,493.00

PRICED IN CANADIAN DOLLARS

PRICES ARE FOB HARRISTON, ONTARIO – DESIGN & PRICE ARE SUBJECT TO CHANGE WITHOUT NOTICE



DEL MORINO FLAIL MOWERS

GINGER	Standard Features
	<ul style="list-style-type: none"> ▪ Cat 1 three point hitch ▪ Aluminum gearbox 540 rpm ▪ Rotary with 'Y' blades or hammers ▪ Universal PTO shaft cat 1

Model #	Working Width	Engine HP	Wt (lbs)	Price (Cdn)
Ginger 96	38"	12 – 25	286	\$2,061.00
Ginger 106	42"	12 – 35	308	\$2,107.00
Ginger 125	50"	12 – 40	330	\$2,350.00

FUNNY TOP	Standard Features
	<ul style="list-style-type: none"> ▪ Cat 1, three point hitch ▪ Aluminum 540 gearbox ▪ 2 belt drive ▪ Y blades or hammers ▪ Adjustable rear roller ▪ Series 2 PTO shaft ▪ Manual offset

Model #	Working Width	Engine HP	Wt (lbs)	Price (Cdn)
Funny Top 80	32"	12 – 30	313	\$2,879.00
Funny Top 93	36"	12 – 30	328	\$3,006.00
Funny Top 106	42"	12 – 30	344	\$3,170.00
Funny Top 132	52"	12 – 30	375	\$3,315.00
Funny Top 158	62"	12 – 30	432	\$3,557.00

PRICED IN CANADIAN DOLLARS

PRICES ARE FOB HARRISTON, ONTARIO – DESIGN & PRICE ARE SUBJECT TO CHANGE WITHOUT NOTICE

5808 Hwy #9, Harriston, Ontario, N0G 1Z0
Phone: 519-338-2923, Fax: 519-338-2756
Email: sales@harcoag.ca
www.harcoag.ca

DelMorino



DEL MORINO FLAIL MOWERS

CENTURION	Standard Features
	<ul style="list-style-type: none"> ▪ Cat 1 three point hitch ▪ Cast iron 540 gearbox ▪ 2 drive belts ▪ Y blades or hammers ▪ Series 4 PTO shaft ▪ Hydraulic side shift, 106=8", 158=11"

Model #	Working Width	Engine HP	Wt (lbs)	Price (Cdn)
Centurion 106	42"	15 – 50	481	\$3,730.00
Centurion 132	52"	15 – 50	567	\$3,947.00
Centurion 158	62"	15 – 50	628	\$4,200.00
Centurion 186	73"	15 – 50	769	\$4,711.00

FLIPPER	Standard Features
	<ul style="list-style-type: none"> ▪ Cat 1&2 three point hitch ▪ Cast iron gearbox ▪ Standard 3 belt drive ▪ Y blades or hammers ▪ Adjustable roller & skid shoes ▪ Series 4 PTO shaft ▪ Hydraulic side shift ▪ Can be mounted front or rear reversible

Model #	Working Width	Engine HP	Wt (lbs)	Price (Cdn)
Flipper 80	32"	15 – 70	388	\$4,270.00
Flipper 106	42"	15 – 70	441	\$4,497.00
Flipper 132	50"	15 – 70	562	\$5,027.00
Flipper 158	62"	15 – 70	635	\$5,314.00
Flipper 186	72"	15 – 70	714	\$5,671.00
Flipper 214	85"	15 – 70	966	\$6,038.00

PRICED IN CANADIAN DOLLARS

PRICES ARE FOB HARRISTON, ONTARIO – DESIGN & PRICE ARE SUBJECT TO CHANGE WITHOUT NOTICE



5808 Hwy #9, Harriston, Ontario, N0G 1Z0
Phone: 519-338-2923, Fax: 519-338-2756
Email: sales@harcoag.ca
www.harcoag.ca

DEL MORINO FLAIL MOWERS

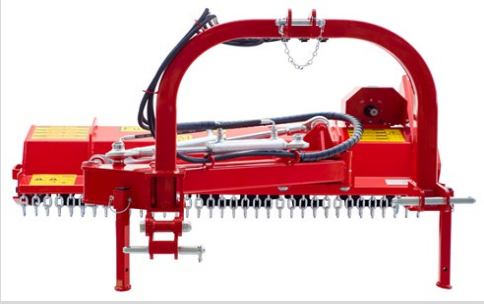
FUNNY SUPER	Standard Features
	<ul style="list-style-type: none"> ▪ Cat 1&2 three point hitch ▪ Aluminum 540 gearbox ▪ 2 drive belts ▪ Y blades or hammers ▪ Adjustable rear roller ▪ Series 4 PTO shaft ▪ 50° down, 90° up cutting head

Model #	Working Width	Engine HP	Wt (lbs)	Price (Cdn)
Funny Super 106	42"	15 – 35	540	\$6,323.00
Funny Super 132	52"	15 – 35	573	\$6,558.00

CENTURION SUPER	Standard Features
	<ul style="list-style-type: none"> ▪ Cat 1&2 three point hitch ▪ Cast iron 540 gearbox ▪ 3 drive belts ▪ Y blades or hammers ▪ Adjustable rear roller ▪ Series 4 PTO shaft ▪ 50° down, 90° up cutting head

Model #	Working Width	Engine HP	Wt (lbs)	Price (Cdn)
Cent Super 106	42"	15 – 60	639	\$6,944.00
Cent Super 132	52"	15 - 60	772	\$7,300.00
Cent Super 158	62"	15 – 60	820	\$7,530.00

PRICED IN CANADIAN DOLLARS

PRICES ARE FOB HARRISTON, ONTARIO – DESIGN & PRICE ARE SUBJECT TO CHANGE WITHOUT NOTICE

5808 Hwy #9, Harriston, Ontario, N0G 1Z0
Phone: 519-338-2923, Fax: 519-338-2756
Email: sales@harcoag.ca
www.harcoag.ca

DEL MORINO FLAIL MOWERS

FLIPPER SUPER	Standard Features
	<ul style="list-style-type: none"> ▪ Cat 1&2 three point hitch w/hydraulic side shift ▪ Counter blade Device ▪ High thickness side, 10 mm ▪ Adjustable rear roller ▪ Wide discharge area ▪ Universal PTO shaft cat 6 – 1800 mm ▪ Y blades or hammers

Model #	Working Width	Engine HP	Wt (lbs)	Price (Cdn)
Flipper Super 132	52"	50 – 80	1036	\$8,730.00
Flipper Super 158	62"	50 – 80	1085	\$9,240.00
Flipper Super 186	72"	50 – 80	1135	\$10,001.00

LEVANTE SUPER	Standard Features
	<ul style="list-style-type: none"> ▪ Transmission by 4 HD belts ▪ Counter blade Device ▪ High thickness side, 10 mm ▪ Wide discharge area ▪ Universal PTO shaft cat 6 – 1800 mm ▪ Y blades or hammers

Model #	Working Width	Engine HP	Wt (lbs)	Price (Cdn)
Levante Super 160	63"	80 – 120	1588	\$12,168.00
Levante Super 190	75"	80 – 120	1669	\$12,999.00
Levante Super 220	87"	80 – 120	1753	\$13,902.00

PRICED IN CANADIAN DOLLARS

PRICES ARE FOB HARRISTON, ONTARIO – DESIGN & PRICE ARE SUBJECT TO CHANGE WITHOUT NOTICE

5808 Hwy #9, Harriston, Ontario, N0G 1Z0
Phone: 519-338-2923, Fax: 519-338-2756
Email: sales@harcoag.ca
www.harcoag.ca



DEL MORINO

Model	Cutting diameter
Ginger	3 cm for blades 4 cm for hammers
Funny	Up to 3-4 cm
Centurion	Up to 4-5cm
Flipper	Up to 5-6 cm
Levante	Up to 6-7 cm

Warranty:

Residential: 2 year parts & labour

Commercial: 1 year parts & labour

PRICED IN CANADIAN DOLLARS

PRICES ARE FOB HARRISTON, ONTARIO – DESIGN & PRICE ARE SUBJECT TO CHANGE WITHOUT NOTICE

TAB 4



Roller Mills
Electric Roller Mills

Low Profile Mills			
Model	Description	Weight (lbs)	Price [USD]
LPM200	Roller Mill	350	Call for pricing
LPE500	Roller Mill	550	Call for pricing
LPE700	Roller Mill	550	Call for pricing

Big Capacity Mills			
Model	Description	Weight (lbs)	Price [USD]
ABC900	Roller Mill	1,094	Call for pricing
ABC1800	Roller Mill	1,452	Call for pricing
ABC3600	Roller Mill	2,260	Call for pricing
ABC5000	Roller Mill	4,500	Call for pricing

Commercial Stacked Mills			
CSU1000	Two-High Stacked Unit		Call for pricing

Electric Roller Mill Options			
Model	Description	Weight (lbs)	Price [USD]
LX200	Auger Base Kit, LPM200	130	Call for pricing
LX500	Auger Base Kit, LPE500	150	Call for pricing
LX700	Auger Base Kit, LPE700		Call for pricing
LX900	Auger Base Kit, ABC900		Call for pricing
LX1800	Auger Base Kit, ABC1800		Call for pricing
LX3600	Auger Base Kit, ABC3600		Call for pricing
LX5000	Auger Base Kit, ABC5000		Call for pricing

Rotary Mill a la Carte			
Model	Description	ARM1665 16" x 6 x 5	ARM16129 16" x 12 x 9
	Base Unit	Call for pricing	Call for pricing
72-0255	PTO Kit	Call for pricing	Call for pricing
72-0252	Trailer Kit	Call for pricing	Call for pricing
72-0254	30 hp Motor Kit	Call for pricing	Call for pricing
		Call for pricing	Call for pricing
72-0262	**No Drive Shield Kit	Call for pricing	Call for pricing
72-0275	Cyclone	Call for pricing	Call for pricing

***Required when no drive kit is ordered.*

PRICED IN UNITED STATES DOLLARS

PRICES ARE FOB PENDER, NEBRASKA IN U.S.D. – SUBJECT TO CHANGE WITHOUT NOTICE



Trailer Roller Mills

(Auger or Blower Discharge Unit, Includes Intake Auger)

PTO Big Capacity Mills

Model	Description	Weight (lbs)	Price [USD]
ATG900A	Auger Discharge Unit		Call for pricing
ATG1820A	Auger Discharge Unit	2,500	Call for pricing
ATG1820B	Blower Discharge Unit	2,450	Call for pricing
ATG3620A	Auger Discharge Unit	3,500	Call for pricing
ATG3620A-SUI	Swing Under Intake	3,900	Call for pricing
ATG3620B	Blower Discharge Unit	2,900	Call for pricing
ATG6000A	Auger Discharge Unit	5,500	Call for pricing
ATG6020	Auger Discharge Unit		Call for pricing
ATG6020-SUI	Swing Under Intake		Call for pricing
ATG10000C	Conveyor Discharge Unit		Call for pricing
ATG15000	Conveyor Discharge Unit		Call for pricing

Trailer Mills a la Carte

Model	Description	Weight (lbs)	Price [USD]
ATG1820	Base Unit		Call for pricing
72-0265	Loading Auger Kit		Call for pricing
72-0266	Discharge Auger Kit		Call for pricing
72-0272	Discharge Blower Kit		Call for pricing
ATG3620	Base Unit		Call for pricing
72-0250	Loading Auger Kit		Call for pricing
72-0251	Discharge Auger Kit		Call for pricing
72-0272	Discharge Blower Kit		Call for pricing
	Swing Under Intake Auger		Call for pricing
ATG6000	Base Unit		Call for pricing
72-0332	Loading Auger Kit		Call for pricing
72-0276	Discharge Auger Kit		Call for pricing
72-0339	Swing Under Intake Auger		Call for pricing

Trailer Hammer Mills

Model	Description	Weight (lbs)	Price [USD]
ATH2000A	Auger Discharge Unit		Call for pricing
ATH2000B	Blower Discharge Unit		Call for pricing

PRICED IN UNITED STATES DOLLARS

PRICES ARE FOB PENDER, NEBRASKA IN U.S.D. – SUBJECT TO CHANGE WITHOUT NOTICE

5808 Hwy #9
 Harriston, Ontario, N0G 1Z0
 519-338-2923, Fax:
 519-338-2756
 sales@harcoag.ca

John B. M. Mfg. Ltd.
4074 Hessen Strasse, St. Clements, ON N0B2M0
Call 800-392-7814 or 519-699-4324 / Fax 519-699-6105

Jan. 1, 2026

Page 1 of 9

Feeder Wagons

Cattleman's Choice Feeder Wagon - with rear entry door							
comes with 245/75R16" used truck tires on 4,000 lb, 6-bolt hubs							
Size	List Price	Size	List Price	Size	List Price	Size	List Price
7' x 12'	\$5,235	7' x 24'	\$7,160	8' x 12'	\$5,500	8' x 24'	\$7,370
7' x 16'	\$5,660	7' x 30'	\$9,155	8' x 16'	\$5,940	8' x 30'	\$9,980
7' x 20'	\$6,505			8' x 20'	\$6,840		
Optional plywood inserts / Add \$63 per foot of length							

Double Bar Feeder Wagon							
comes with 245/75R16" used truck tires on 4,000 lb, 6-bolt hubs							
Size	List Price	Size	List Price	Size	List Price	Size	List Price
7' x 12'	\$4,825	7' x 24'	\$6,690	8' x 12'	\$5,160	8' x 24'	\$7,105
7' x 16'	\$5,375	7' x 30'	\$8,240	8' x 16'	\$5,655	8' x 30'	\$8,925
7' x 20'	\$6,035			8' x 20'	\$6,365		

Portable Bunk Feeder Wagon - with rear entry door							
comes with 245/75R16" used truck tires on 4,000 lb, 6-bolt hubs							
Size	List Price	Size	List Price	Size	List Price	Size	List Price
5' x 12'	\$4,050	5' x 20'	\$4,775	6' x 12'	\$4,220	6' x 20'	\$4,975
5' x 16'	\$4,415	5' x 24'	\$4,960	6' x 16'	\$4,610	6' x 24'	\$5,150

TMR Feeder Wagon - with rear entry door							
comes with 245/75R16" used truck tires on 4,000 lb, 6-bolt hubs							
Size	List Price	Size	List Price	Size	List Price	Size	List Price
7' x 12'	\$4,500	7' x 20'	\$5,455	7' x 24'	\$5,770	7' x 30'	\$7,320
7' x 16'	\$4,940						

Econo Zero Grazer Feeder Wagon - with plywood inserts							
comes with 245/75R16" used truck tires on 5,000 lb, 6-bolt hubs							
Size	List Price	Size	List Price	Size	List Price	Size	List Price
7' x 12'	\$4,915	7' x 16'	\$5,980	7' x 20'	\$6,645	7' x 24'	\$7,170

Tombstone Feeder Wagon							
comes with 245/75R16" used truck tires on 4,000 lb, 6-bolt hubs							
Size	List Price	Size	List Price	Size	List Price	Size	List Price
7' x 12'	\$4,560	7' x 16'	\$5,030	7' x 20'	\$5,655	7' x 24'	\$6,255

Self Locking Feeder Wagon			
comes with 245/75R16" used truck tires on 5,000 lb, 6-bolt hubs			
Size	No. of locks	List Price	
16'	19	\$7,330	
20'	23	\$8,645	
24'	27	\$9,595	

30' long feeder wagons come standard with a double rear axle and 5,000 lb, 6-bolt hubs

Optional items for feeder wagons	List Price
Add second rear axle w/ used truck tires - for feeder wagons under 30' long	plus \$810
Upgrade to new 11L x 15" 8-ply tires - for feeder wagons with 4 wheels	plus \$360
Less rims and used truck tires - for feeder wagons with 4 wheels	less \$400

FOB St. Clements, Ontario *all prices subject to change without notice *HST not included in prices

Feeders and Feed Fronts

Heavy Duty Bunk Feeder - with entry door					
Size	List Price	Size	List Price	Size	List Price
4' x 10'	\$1,895	5' x 10'	\$2,060	6' x 10'	\$2,210
4' x 12'	\$2,070	5' x 12'	\$2,295	6' x 12'	\$2,520
4' x 16'	\$2,230	5' x 16'	\$2,480	6' x 16'	\$2,740
4' x 20'	\$2,550	5' x 20'	\$2,785	6' x 20'	\$3,010
4' x 24'	\$2,820	5' x 24'	\$3,005	6' x 24'	\$3,190

**Optional kick panel
add \$32
per linear foot**

Heavy Duty Tub Feeder				Fence Line Bunk Feeder			
Size	List Price	Size	List Price	Size	List Price	Size	List Price
34" x 8'	\$920	48" x 8'	\$1,065	34" x 8'	\$1,235	34" x 18'	\$1,855
34" x 10'	\$1,055	48" x 10'	\$1,220	34" x 10'	\$1,420	34" x 20'	\$1,925
34" x 12'	\$1,265	48" x 12'	\$1,480	34" x 12'	\$1,480	34" x 22'	\$2,005
34" x 16'	\$1,575	48" x 16'	\$1,780	34" x 14'	\$1,530	34" x 24'	\$2,165
34" x 20'	\$1,770	48" x 20'	\$1,900	34" x 16'	\$1,650		
34" x 24'	\$1,975	48" x 24'	\$2,125				

48" width available / add \$20 per foot of length

Optional kick panel / add \$32 per linear foot

Double Bar Rectangular Feeder - with 8" or 12" double bar spacing							
Size	Bale Size	List Price 12"	List Price 8"	Size	Bale Size	List Price 12"	List Price 8"
7' x 8'	4' to 5' bale	\$2,120	\$2,240	8' x 8'	5' to 6' bale	\$2,340	\$2,465
7' x 12'	4' to 5' bale	\$2,770	\$2,935	8' x 12'	5' to 6' bale	\$2,975	\$3,210
7' x 16'	4' to 5' bale	\$3,445	\$3,585	8' x 16'	5' to 6' bale	\$3,705	\$3,905

Optional entry door / add \$265

12" extension on top / add \$27 per foot of length

Rectangular Feeder - with open crossbar floor					
Size	List Price	Size	List Price	Size	List Price
5' x 8'	\$1,125	6' x 8'	\$1,215	7' x 8'	\$1,280
5' x 12'	\$1,440	6' x 12'	\$1,525	7' x 12'	\$1,650
5' x 16'	\$1,860	6' x 16'	\$1,935	7' x 16'	\$2,000

**Optional double bars
spaced 12" / add \$40
per foot of length**

Tombstone Feeder				Big Ben Horse Feeder			
Size	List Price	Size	List Price	Size	List Price	Size	List Price
7' x 8'	\$1,915	8' x 8'	\$2,060	8' x 8'	\$2,390	8' x 12'	\$3,065
7' x 12'	\$2,655	8' x 12'	\$2,770				
7' x 16'	\$3,360	8' x 16'	\$3,500				

Comes standard with double bars spaced 8"

Optional entry door / add \$265

Self Locking Feeder					
Size	No. of locks	List Price	Size	No. of locks	List Price
8'	14	\$3,405	16'	22	\$5,415
10'	16	\$4,010	20'	26	\$6,300
12'	18	\$4,440	24'	30	\$7,090

Heavy Duty Feed Front			Self Locking Feed Front		
Size / List Price	Size / List Price	Size / List Price	Size	No. of locks	List Price
4' / \$180	11' / \$475	18' / \$760	2'	1	\$240
5' / \$220	12' / \$510	19' / \$800	4'	2	\$410
6' / \$265	13' / \$550	20' / \$835	6'	3	\$600
7' / \$310	14' / \$595	21' / \$885	8'	4	\$780
8' / \$335	15' / \$620	22' / \$925	10'	5	\$975
9' / \$385	16' / \$670	23' / \$965	12'	6	\$1,160
10' / \$430	17' / \$715	24' / \$1,015			

Comes standard with 20" skirt - 54" total height

**Optional 12" skirt
add \$32 per foot of length**

Flat Racks

Farm Boss Flat Rack - with 10" channel beams					
Size	Mesh List Price	Checker Plate List Price	Size	Mesh List Price	Checker Plate List Price
8.5' x 20'	\$4,175	\$4,740	9' x 20'	\$4,865	\$5,650
8.5' x 22'	\$4,435	\$5,075	9' x 22'	\$5,110	\$6,035
8.5' x 24'	\$4,775	\$5,440	9' x 24'	\$5,395	\$6,310
8.5' x 26'	\$5,055	\$5,870	9' x 26'	\$5,615	\$6,570
8.5' x 28'	\$5,330	\$6,180	9' x 28'	\$5,880	\$6,820
8.5' x 30'	\$5,640	\$6,510	9' x 30'	\$6,120	\$7,070
8.5' x 32'	\$6,325	\$7,235	9' x 32'	\$6,460	\$7,430
8.5' x 36'	\$7,370	\$8,360	9' x 36'	\$7,790	\$8,825

Regular Duty Flat Rack - with 6" channel beams					
Size	Mesh List Price	Checker Plate List Price	Size	Mesh List Price	Checker Plate List Price
8.5' x 16'	\$3,005	\$3,520	8.5' x 22'	\$3,790	\$4,500
8.5' x 18'	\$3,250	\$3,835	8.5' x 24'	\$4,095	\$4,855
8.5' x 20'	\$3,480	\$4,135			

Bale King Rack - with 10" channel beams							
Size	List Price	Size	List Price	Size	List Price	Size	List Price
8.5' x 16'	\$2,525	8.5' x 28'	\$4,350	9' x 16'	\$3,250	9' x 28'	\$4,710
8.5' x 18'	\$3,025	8.5' x 30'	\$4,500	9' x 18'	\$3,725	9' x 30'	\$4,930
8.5' x 20'	\$3,330	8.5' x 32'	\$4,820	9' x 20'	\$3,820	9' x 32'	\$5,270
8.5' x 22'	\$3,575	8.5' x 36'	\$5,515	9' x 22'	\$3,995	9' x 36'	\$5,965
8.5' x 24'	\$3,820			9' x 24'	\$4,160		

Comes standard with 2 slant end gates / 12" beams standard on 36' long racks

Mini Rack with Compact Wagon	Mini Rack only
for ATV or compact tractor	List Price
4' x 8' mesh rack on 2-ton running gear	\$3,725
	\$1,800

Comes standard with 2 slant end gates & a 3' upright rear end gate

All flat racks come standard with high visibility SMV signs

Optional items for flat racks	List Price
Tie down chains - to secure rack to running gear	\$65
Riser kit - to provide clearance for large tires	\$160
5' upright end gate	\$325
Extended rear hitch	\$340
LED rear light kit with 15' perma-coil cord, 7-pin front plug, and 7-pin rear plug	\$800
Winch track - 6' length with angle on opposite side to catch strap hook	\$195
Winch with 3" x 30' strap	\$195
Reach supports - to stabilize 24' long round reach poles	\$215
Horst running gear	call for pricing

FOB St. Clements, Ontario *all prices subject to change without notice *HST not included in prices

When customers order one of our bale racks with a rear light kit, the rear light kit will now include a rear plug, which allows a second wagon with lights to be connected to the first, so all taillights work together.

Round Bale Carriers

Round Bale Racks								
to fit 4' diameter round bales			to fit 5' diameter round bales			to fit 6' diameter round bales		
	Straight Crossbars	Curved Crossbars		Straight Crossbars	Curved Crossbars		Straight Crossbars	Curved Crossbars
Size	List Price	List Price	Size	List Price	List Price	Size	List Price	List Price
8.5' x 20'	\$2,685	\$2,795	8.5' x 20'	\$2,455	\$2,560	8.5' x 20'	\$2,285	\$2,350
8.5' x 24'	\$3,160	\$3,250	8.5' x 24'	\$2,945	\$3,045	8.5' x 24'	\$2,680	\$2,770
8.5' x 30'	\$3,760	\$3,850	8.5' x 30'	\$3,575	\$3,635	8.5' x 30'	\$3,250	\$3,365
8.5' x 36'	\$4,855	\$4,895	8.5' x 36'	\$4,440	\$4,490	8.5' x 36'	\$4,160	\$4,360

Round bale racks come standard with 2 slant end gates, high visibility SMV signs and 10" channel beams - 12" beams are standard on 36' long racks

Optional items for round bale racks	List Price
5" x 3" tubing rub rail - welded to crossbar ends	\$32 per foot of rack length
Tie down chains - to secure rack to running gear	\$65
Riser kit - to provide clearance for large tires	\$160
Extended rear hitch	\$340
LED rear light kit with 15' perma-coil cord, 7-pin front plug, and 7-pin rear plug	\$800
Reach supports - to stabilize 24' long round reach poles	\$215
Horst running gear	call for pricing

Mighty Bale Haulers			
20' lengths come standard with 5,000 lb, 6-bolt hubs			
Size	Bale Size	Tire Option	List Price
8.5' x 20'	4' to 5' bale	Less rims & tires	\$4,725
8.5' x 20'	4' to 5' bale	245/75R16" used truck tires	\$5,105
8.5' x 20'	4' to 5' bale	11L x 15" 8-ply tires	\$5,670
8.5' x 20'	6' bale	Less rims & tires	\$4,565
8.5' x 20'	6' bale	245/75R16" used truck tires	\$4,940
8.5' x 20'	6' bale	11L x 15" 8-ply tires	\$5,500
24' lengths come standard with 5,000 lb, 6-bolt hubs on the front, and 5,500 lb, 8-bolt hubs on the rear			
Size	Bale Size	Tire Option	List Price
8.5' x 24'	4' to 5' bale	Less rims & tires	\$5,465
8.5' x 24'	4' to 5' bale	FRONT - 17' used truck tires REAR - 19.5" used truck tires	\$5,850
8.5' x 24'	4' to 5' bale	FRONT - 11L x 15" 8-ply tires REAR - 12.5L x 15" 12-ply tires	\$6,440
8.5' x 24'	6' bale	Less rims & tires	\$5,305
8.5' x 24'	6' bale	FRONT - 17' used truck tires REAR - 19.5" used truck tires	\$5,695
8.5' x 24'	6' bale	FRONT - 11L x 15" 8-ply tires REAR - 12.5L x 15" 12-ply tires	\$6,265

FOB St. Clements, Ontario *all prices subject to change without notice *HST not included in prices

Dump Trailers

T150 Mighty Dumper	
Tandem axle / 1.5-ton capacity / Spring latch tailgate	
Dump box dimensions: 4' wide x 6.5' long with 18" high sides	
Tire Option	List Price
18 x 8.50-8 4-ply tires	\$4,640
Optional / Hydraulic power pack - includes pump, oil reservoir, remote, and 12v battery	\$2,345

S500 Mighty Dumper	
Single axle / 5-ton capacity / Self-opening tailgate with grain door	
Dump box dimensions: 6' wide x 10' long with 24" high sides	
Tire Option	List Price
245/75R16" used truck tires	\$7,850
11L x 15" 8-ply tires	\$7,935
Optional / Safety chains- includes 2 grade 70, 3/8" x 3' safety chains with snap hooks	\$155
Optional / LED rear light kit - includes 15' perma-coil cord & 7-pin plug	\$800
Optional / Hydraulic power pack - includes pump, oil reservoir, remote, and 12v battery	\$2,345

S500L Mighty Dumper - low side	
Single axle / 5-ton capacity / Wood plank for tailgate	
Dump box dimensions: 6' wide x 10' long with 12" high sides	
Tire Option	List Price
245/75R16" used truck tires	\$7,140
11L x 15" 8-ply tires	\$7,225
Optional / Safety chains- includes 2 grade 70, 3/8" x 3' safety chains with snap hooks	\$155
Optional / LED rear light kit - includes 15' perma-coil cord & 7-pin plug	\$800
Optional / Hydraulic power pack - includes pump, oil reservoir, remote, and 12v battery	\$2,345

T800 Mighty Dumper	
Tandem axle / 8-ton capacity / Self-opening tailgate with grain door	
Dump box dimensions: 6' wide x 10' long with 24" high sides	
Tire Option	List Price
245/75R16" used truck tires	\$8,990
11L x 15" 8-ply tires	\$9,115
Optional / Safety chains- includes 2 grade 70, 3/8" x 3' safety chains with snap hooks	\$155
Optional / LED rear light kit - includes 15' perma-coil cord & 7-pin plug	\$800
Optional / Hydraulic power pack - includes pump, oil reservoir, remote, and 12v battery	\$2,345

T800L Mighty Dumper - low side	
Tandem axle / 8-ton capacity / Wood plank for tailgate	
Dump box dimensions: 6' wide x 10' long with 12" high sides	
Tire Option	List Price
245/75R16" used truck tires	\$8,225
11L x 15" 8-ply tires	\$8,445
Optional / Safety chains- includes 2 grade 70, 3/8" x 3' safety chains with snap hooks	\$155
Optional / LED rear light kit - includes 15' perma-coil cord & 7-pin plug	\$800
Optional / Hydraulic power pack - includes pump, oil reservoir, remote, and 12v battery	\$2,345

Dump Trailers (continued)

T1200 Mighty Dumper	
Tandem axle / 12-ton capacity / Self-opening tailgate with grain door	
Dump box dimensions: 7' wide x 12' long with 36" high sides	
Tire Option	List Price
12.5L x 15" load range F highway service tires	\$13,585
400/60 x 15.5" 14-ply flotation tires	\$14,420
Optional / Safety chains- includes 2 grade 70, 3/8" x 3' safety chains with snap hooks	\$155
Optional / LED rear light kit - includes 15' perma-coil cord & 7-pin plug	\$800
Optional / Hydraulic tailgate	\$1,150

T1200H Mighty Dumper - high side	
Tandem axle / 12-ton capacity / Self-opening tailgate with grain door	
Dump box dimensions: 7' wide x 12' long with 54" high sides	
Tire Option	List Price
12.5L x 15" load range F highway service tires	\$14,420
400/60 x 15.5" 14-ply flotation tires	\$14,975
Optional / Safety chains- includes 2 grade 70, 3/8" x 3' safety chains with snap hooks	\$155
Optional / LED rear light kit - includes 15' perma-coil cord & 7-pin plug	\$800
Optional / Hydraulic tailgate	\$1,150

T1200LM Load Master	
Tandem axle / 12-ton capacity / Hydraulic tailgate	
Dump box dimensions: 7' wide x 12' long with 24" high sides	
Tire Option	List Price
500/50 x 17" 18-ply flotation tires	\$23,740
Optional / Safety chains- includes 2 grade 70, 3/8" x 3' safety chains with snap hooks	\$155
Optional / LED rear light kit - includes 15' perma-coil cord & 7-pin plug	\$800

T1200DB Dirt Boss	
Tandem axle / 12-ton capacity / Hydraulic tailgate with grain door	
Dump box dimensions: 7' wide x 12' long with 24" high sides	
Tire Option	List Price
12.5L x 15" load range F highway service tires	\$15,265
400/60 x 15.5" 14-ply flotation tires	\$16,100
425/65R22.5" used truck tires	\$19,015
500/50 x 17" 18-ply flotation tires	\$20,265
Optional / Safety chains- includes 2 grade 70, 3/8" x 3' safety chains with snap hooks	\$155
Optional / LED rear light kit - includes 15' perma-coil cord & 7-pin plug	\$800

T1500DB Dirt Boss	
Tandem axle / 15-ton capacity / Hydraulic tailgate with grain door / Safety chains included	
Dump box dimensions: 7.5' wide x 16' long with 30" high sides	
Tire Option	List Price
445/50R22.5" used truck tires	\$29,625
600/50 x 22.5" 16-ply flotation tires	\$32,815
Optional / LED rear light kit - includes 15' perma-coil cord & 7-pin plug	\$800
Optional / 2-wheel hydraulic disc brakes	\$4,170

Dump Trailers (continued)

T1500GFB Grain & Forage Boss	
Tandem axle / 15-ton capacity / Hydraulic tailgate with grain door / Safety chains included Dump box dimensions: 7.5' wide x 16' long with 30" high sides	
Tire Option	List Price
445/50R22.5" used truck tires	\$30,695
600/50 x 22.5" 16-ply flotation tires	\$34,030
Optional / LED rear light kit - includes 15' perma-coil cord & 7-pin plug	\$800
Optional / 2-wheel hydraulic disc brakes	\$4,170

T2000LM Load Master	
Tandem axle / 20-ton capacity / Hydraulic tailgate / Safety chains, LED rear light kit, and 2-wheel disc brakes included Dump box dimensions: 8' wide x 12' long with 54" high sides	
Tire Option	List Price
600/50 x 22.5" 16-ply flotation tires	\$53,085

Reach Length Guide

For Farm Boss, Regular Duty, Bale King & Round Bale Racks

Please select correct reach pole length if ordering running gear directly from Horst Welding

**Please note, for Horst model 145 wagons ONLY:
 The optional 10' round reach pole is required if putting a 16', 18', or 20' rack on top**

Rack Length	Round Reach Poles	Square Reach Poles
36 foot rack length	24' reach length	22' reach length
32 foot rack length	22' reach length	20' reach length
30 foot rack length	20' reach length	18' reach length
28 foot rack length	18' reach length	16' reach length
26 foot rack length	18' reach length	16' reach length
24 foot rack length	16' reach length	14' reach length
22 foot rack length	16' reach length	14' reach length
20 foot rack length	14' reach length	N/A
18 foot rack length	12' reach length	N/A
16 foot rack length	11' reach length	N/A

Round Bale Rack - Bar Spacing & Bale Capacity

4' diameter bales			
Rack Length	Bar Spacing	# of Bars	Bale Capacity
20 feet	~25.5 inches	10 bars / 5 sets	14 (5+5+4)
24 feet	~25.5 inches	12 bar / 6 sets	17 (6+6+5)
30 feet	~27 inches	14 bars / 7 sets	20 (7+7+6)
36 feet	~25 inches	16 bars / 8 sets	23 (8+8+7)

5' diameter bales			
Rack Length	Bar Spacing	# of Bars	Bale Capacity
20 feet	~33 inches	8 bars (4 sets)	11 (4+4+3)
24 feet	~31 inches	10 bars / 5 sets	14 (5+5+4)
30 feet	~32 inches	12 bar / 6 sets	17 (6+6+5)
36 feet	~32.75 inches	14 bars / 7 sets	20 (7+7+6)

6' diameter bales			
Rack Length	Bar Spacing	# of Bars	Bale Capacity
20 feet	~45 inches	6 bars (3 sets)	8 (3+3+2)
24 feet	~40 inches	8 bars (4 sets)	11 (4+4+3)
30 feet	~39 inches	10 bars / 5 sets	14 (5+5+4)
36 feet	~ 38.5 inches	12 bar / 6 sets	17 (6+6+5)

When customers order one of our bale racks with a rear light kit, the rear light kit will now include a rear plug, which allows a second wagon with lights to be connected to the first, so all taillights work together.

Additional Dump Trailer Dimensions

T150 Mighty Dumper		S500 Mighty Dumper		S500L Mighty Dumper	
Overall length	10' 5"	Overall length	16' 2"	Overall length	16' 2"
Overall width	51"	Overall width	82"	Overall width	76"
Overall height	45"	Overall height	69"	Overall height	55"
Deck height	26"	Deck height	36"	Deck height	36"
Track width	41"	Track width	57"	Track width	57"
Maximum dump angle	48°	Maximum dump angle	53°	Maximum dump angle	53°
Bushel capacity	31	Bushel capacity	96	Bushel capacity	48
Approximate weight	1,000 lbs	Approximate weight	2,500 lbs	Approximate weight	2,300 lbs

T800 Mighty Dumper		T800L Mighty Dumper		T1200 Mighty Dumper	
Overall length	16' 2"	Overall length	16' 2"	Overall length	18'
Overall width	82"	Overall width	76"	Overall width	96"
Overall height	68"	Overall height	55"	Overall height	91"
Deck height	36"	Deck height	36"	Deck height	40"
Track width	58"	Track width	58"	Track width	68"
Maximum dump angle	53°	Maximum dump angle	53°	Maximum dump angle	48°
Bushel capacity	96	Bushel capacity	48	Bushel capacity	201.6
Approximate weight	3,500 lbs	Approximate weight	3,000 lbs	Approximate weight	4,000 lbs

T1200H Mighty Dumper		T1200LM Load Master		T1200DB Dirt Boss	
Overall length	18'	Overall length	18'	Overall length	18'
Overall width	96"	Overall width	93"	Overall width	96"
Overall height	109"	Overall height	85"	Overall height	91"
Deck height	40"	Deck height	43.75"	Deck height	40"
Track width	68"	Track width	70.5"	Track width	68"
Maximum dump angle	48°	Maximum dump angle	48°	Maximum dump angle	48°
Bushel capacity	302.4	Bushel capacity	127.6	Bushel capacity	134.4
Approximate weight	4,500 lbs	Approximate weight	5,600 lbs	Approximate weight	6,000 lbs

T1500DB Dirt Boss		T1500GFB Grain & Forage Boss		T2000LM Load Master	
Overall length	22' 6"	Overall length	22' 6"	Overall length	22' 11"
Overall width	102"	Overall width	102"	Overall width	106"
Overall height	93"	Overall height	123"	Overall height	106"
Deck height	51"	Deck height	51"	Deck height	53"
Track width	74"	Track width	74"	Track width	101"
Maximum dump angle	48°	Maximum dump angle	48°	Maximum dump angle	53°
Bushel capacity	240	Bushel capacity	480	Bushel capacity	307.2
Approximate weight	9,000 lbs	Approximate weight	9,000 lbs	Approximate weight	10,275 lbs

One Year Limited Warranty

JBM warrants all new products that we manufacture to be free of defects in materials and workmanship for a period of 1 year*, under normal use and service.

JBM's obligation under this warranty shall be limited to the repair or replacement of any product or component of a product, proven to be defective in materials or workmanship under normal use and service.

"Normal use and service" means usage in a manner for which such goods are generally used, and in a manner which does not subject the equipment to conditions outside of those normally imposed through proper use. Evidence of improper use, neglect, unapproved repair, or alteration to the original design of JBM products will void this warranty.

Customers should contact the local dealer from which they purchased the product if issues develop within the warranty period. Only JBM authorized dealers may make repairs to a product or initiate the repair or replacement of defective parts, unless otherwise approved by JBM.

Distributors and Dealers should notify JBM of any defect before repair or replacement is made. Recommended repairs, replacement, and cost are to be discussed with, and agreed upon, by a representative of JBM.

All claims must be accompanied by a photograph of the defective product

This warranty does not cover the following items:

- Regular maintenance and adjustments
- Items lost or damaged during shipment
- Accessory items and components not supplied by JBM
- Damages resulting from:
 - misuse, negligence, accident, theft or fire
 - use of improper or insufficient fluids or lubricants
 - use of after market accessories or components, unless approved by JBM
 - modifications, alteration, tampering or improper repair

A warranty claim must be made through an authorized JBM dealer. The dealer must contact JBM and receive approval prior to performing any warranty work. Failure to obtain prior approval will result in a warranty claim being rejected.

There is no warranty, expressed or implied, other than that which is specified herein. No other agent or person has authority to impose additional provisions to this warranty.

JBM shall not, in any event, be liable for any losses, damages, or costs, including profits, travel, transportation, pick up, delivery, towing costs, or loss of use, whether special, incidental, consequential or otherwise, in any way.

All claims must be discussed with a representative of JBM prior to any repairs being made.

***Tires are covered by warranty for a period of 90 days. Any tire found by JBM to be defective within the 90-day warranty period will be exchanged for free if it is returned on the rim that it came with.**

5808 Hwy #9, Harriston, Ontario, N0G 1Z0
Phone: 519-338-2923, Fax: 519-338-2756
Email: sales@harcoag.ca
www.harcoag.ca



Standard Model 760



Roto Grind Tub Grinder Models



Low Profile Model 760

Roto Grind Tub and Grain Grinders

Burrows Enterprises, LLC. 2024 East 8th Street, Greeley, Colorado 80631

Phone: (970) 353-3769***Fax: (970) 353-0839

Website: www.rotogrind.com

ROTO GRIND PRICE LIST

Suggested Retail - U.S. Funds

Roto Grind Tub Grinders are complete with the following standard equipment:

Tub Control Governor, Tub Speed Control, Hydraulic Hoses, Adjustable Riser,
Standard Curved Spout, Tires Mounted, Shear Bolt, P.T.O., Swivel for Spout,
Hardened Hammer Pins, Hard Surfaced Lead Hammers and Standard Hammers.

Model # 760 - High Profile Tub Grinder w/52" Deep Tub (Overall Height 8'6")
With 7" mill housing and standard equipment listed above **\$31,600.00**

Model # 760 - Low Profile Tub Grinder w/36" Deep Tub (Overall Height 7'6")
With 7" mill housing and standard equipment listed above **\$31,400.00**

Model # 1090 - High Profile Tub Grinder w/52" Deep Tub (Overall Height 8'8")
With 10" mill housing and standard equipment listed above **\$34,775.00**

Model # GG7 - Grain Grinder w / 3-point attachment 7" mill housing & Water kit_ **\$14,950.00**
With wheels & 12'x 10" hyd. Auger **\$22,500.00**

Model # GG10 Grain Grinder w/ 3-point attachment 10" mill housing & Water kit **\$16,725.00**
With wheels & 12'x 10" hyd. Auger **\$25,110.00**

Conversion Kit to add Hydraulic Auger option to 3PT Grain Grinders **\$5,055.00**

Call for pricing on Custom orders or machines with electric motor.
Assembled prices, suggested retail F.O.B. Manufacturing Plant.
Prices are subject to change without notice.

Teagle

Tomahawk 505M

Description Chop bales of dry material to a consistently short length for feeding or bedding applications. · 5ft. Diameter Round Bales · 4ft. x 4ft. x 8ft Rectangular Bales · Dry Material Only · Distance Blown >23ft @ 1000		Specifications · 3 Pt. Cat 2 /3 **NEW** · 1000 RPM · Slip & Overrun Clutch PTO · Single acting Hyd.Drum Drive · PTO req. min. 80hp Std Drum/ 100 hp XLM Drum · Weight 2310lbs. · Std. Drum Length 5ft. · Supplied with One Screen			
Additional Information is available on the Teagle website					
Item	Part Number	Description	Price		
Base machine	T505M	Tomahawk 505M c/w 5ft. Drum Knife Rotor (std. production) with 72" Drum Length in Lieu of Standard 5 ft. & Hydraulic Top Link, Left hand lower chute.	\$34,563.00		
Tomahawk 505XLM	T505XLM	9ft. Drum Length Machine for rectangular bales & Hydraulic Top Link, Left hand lower chute.	\$41,318.00		
All Screen are now manufactured in Abrasive Resistant Steel (Hardox) Please specify which size is to be supplied at time of machine order	SC1775	5/16" Screen	\$1,733.00 for each additional screen		
	SC1674	3/8" Screen			
	SC1673	1/2" Screen			
	SC1676	19/32" Screen			
	SC1695	23/32" Screen			
	SC1660	13/16" Screen			
	SC1776	1" Screen			
	SC1677	1-1/8" Screen			
	SC1661	1-7/16" Screen			
	SC1771	2"x1-5/8" Slotted Screen			
SC1662	5" x 1-5/8" Slotted Screen				
PTO Options					
6 Spline PTO - Standard	PTO8125	6 Spline Tractor End	Std.		
21 Spline PTO - in lieu	PTO8127	21 Spline Tractor End In Lieu of 6 Spline	\$0.00		
6 Spline WAJ PTO - in lieu	PTO8130	6 Spline Tractor End WAJ at Machine end	\$1,505.00		
Chute Options					
Left Hand Lower Chute	SC1867	Left Hand Lower Discharge Chute	Std.		
<i>Options Lower Chute</i>	SC1873	Hose Adaptor (7" Dia.) for SC1867	\$648.00		
	SC1871	135 deg. Rearward lower chute deflector for SC1867	\$1,348.00		
Left Hand Giraffe Chutes	SC1227	Chute for Dry material only	\$1,575.00		
	SC1964	Mechanical Swivel Chute Dry Material	\$2,345.00		
<i>Options L/H Giraffe Chutes</i>	SC1337	Hyd. Control Discharge Flap on SC1227	\$1,523.00		
	SC1966	Hyd. Rotation Kit for SC1964	\$1,575.00		
	SC1442	Hyd. Control Discharge Flap on SC1964	\$1,523.00		
Right Hand Chute			Std.		
<i>Options R/H Chute</i>	SC1725	Hydraulic Control RH Chute Flap	\$1,505.00		
Miscellaneous Options					
Hyd. Flow Control	SC1332	Drum Speed when no Flow/Control on Tractor	\$963.00		
Hydraulic Top Link	HTL	Hydraulic Top Link Cat 2/3 - with check valve	Std. \$1,575.00		
Dust Supression					
Tailgate Mesh	SC2230	Fine Mesh For Tailgate	\$1,103.00		
Dust seal kit	SC2254 + SC1996	Drum/Backplate seal kit, including brush seal	\$1,278.00		
Liquid Spray Kit	SC2350 + EC1038	Tank, power lead enclosure, hose and nozzles	\$3,850.00		

PRICED IN CANADIAN DOLLARS

PRICES ARE FOB HARRISTON, ONT. IN CDN DOLLARS – DESIGN & PRICE ARE SUBJECT TO CHANGE WITHOUT NOTICE

Our right of continuous improvement has been implemented without prior notification. It does not constitute that these improvements and changes were applied to end user, retailing dealer or distributor inventory. Product improvements will apply only as production schedules permit. All dimensions are approximate.

Teagle

Tomahawk 5050

Description Chop bales of straw or shred silage for feeding or bedding applications. <ul style="list-style-type: none"> 5ft. Diameter Round Bales 4ft. x 4ft. x 8ft Rectangular Bales Wet & Dry Material Distance Blown 25ft. @ 540 Distance Blown >30ft. @ 1000 		Specifications <ul style="list-style-type: none"> 3 Pt. Cat 2 /3 **NEW** 540 or 1000 RPM Slip & Overrun Clutch PTO Single acting Hyd.Drum Drive PTO req. min. 80hp Std Drum/ 100 hp XL Drum Weight 2105lbs. Std Drum Length 5ft. 			
Additional Information is available on the Teagle website					
Item	Part Number	Description	Price		
Base machine	T5050	Tomahawk 5050 with 6' drum length in lieu of standard 5' drum, c/w hydraulic top link & left hand lower discharge chute.	\$33,635.00		
Tomahawk 5050XLM	T5050XL	Tomahawk 5050XL with 9' drum length machine for rectangular bales, c/w hydraulic top link & left hand lower discharge chute.	\$40,688.00		
PTO Options					
6 Spline PTO - Standard	PTO8125	6 Spline Tractor End	Std.		
21 Spline PTO - in lieu	PTO8127	21 Spline Tractor End In Lieu of 6 Spline	\$0.00		
6 Spline WAJ PTO - in lieu	PTO8130	6 Spline Tractor End WAJ at Machine end	\$1,505.00		
Chute Options					
Left Hand Lower Chute	SC1867	Left Hand Lower Discharge Chute	\$648.00		
<i>Options Lower Chute</i>	SC1873	Hose Adaptor (7" Dia.) for SC1867	\$648.00		
	SC1871	135 deg. Rearward lower chute deflector for SC1867	\$1,330.00		
Left Hand Giraffe Chutes	SC1305	Chute for Silage, Hay & Straw	\$2,013.00		
	SC1964	Mechanical Swivel Chute Dry Material	\$2,345.00		
<i>Options L/H Giraffe Chutes</i>	SC1338	Hyd. Control Discharge Flap on SC1305	\$1,523.00		
	SC1966	Hyd. Rotation Kit for SC1964	\$1,575.00		
	SC1442	Hyd. Control Discharge Flap on SC1964	\$1,505.00		
Right Hand Chute			Std.		
<i>Options R/H Chute</i>	SC1339	Hydraulic Control RH Chute Flap	\$1,523.00		
Strawberry Chute Kit	SC1876	Requires Lower Chute Kit SC1867	\$1,890.00		
Miscellaneous Options					
Hyd. Flow Control	SC1332	Drum Speed when no Flow/Control on Tractor	\$963.00		
Hydraulic Top Link	HTL	Hydraulic Top Link Cat 2/3 - with check valve	Std. 1,575.00		
Dust Suppression					
Tailgate Mesh	SC2230	Fine Mesh For Tailgate	\$1,103.00		

PRICED IN CANADIAN DOLLARS

PRICES ARE FOB HARRISTON, ONT. IN CDN DOLLARS – DESIGN & PRICE ARE SUBJECT TO CHANGE WITHOUT NOTICE

Our right of continuous improvement has been implemented without prior notification. It does not constitute that these improvements and changes were applied to end user, retailing dealer or distributor inventory. Product improvements will apply only as production schedules permit. All dimensions are approximate.

Teagle Tomahawk 500B

Description Process material outside, distribute inside for increased bio security. The booster fan with on-board hydraulic system (PTO driven) can transfer straw up to 320ft. · 5ft. Diameter Round Bales · 4ft. x 4ft. x 8ft. Rectangular Bales · Dry Material Only · Includes radio remote drum control	Specifications · 3 Pt. Cat 2/3 · 1000 RPM · Slip & Overrun Clutch WAJ PTO · Single acting Hyd.Drum Drive · PTO req. min. 120 hp · Weight 3065lbs. · Weight 3840lbs. (XLM).	
------------------------------------------------------------------------------------------------------------------------------------------------------------------------------------------------------------------------------------------------------------------------------------------------------------------------------------------	--------------------------------------------------------------------------------------------------------------------------------------------------------------------------------------------------------	-------------------------------------------------------------------------------------

Additional Information is available on the Teagle website

Item	Part Number	Description	Price
9ft Tomahawk 505BXL	500BXL	9ft. Drum Length in Lieu of Standard 5ft.	\$72,503.00

Rotor / Screen Options - See T505M			
Chute Options			
Non-supply of RH Chute		For improved straw containment	\$525.00
PTO Options			
6 Spline WAJ PTO	PTO8130	6 Spline Tractor End WAJ at Machine end	Std.
Miscellaneous Options			
Hyd. Flow Control	SC1332	Drum Speed when no Flow/Control on Tractor	Std.
Booster Fan Options			
127mm Hose Kit x 20m	SC2307	Complete with male coupler and clips	\$2,275.00
Straw Divertor Valve	SC2336	Asymmetric diverter valve L/H	\$2,170.00
Straw Divertor Valve	SC2341	Asymmetric diverter valve R/H	\$2,170.00
Straw Divertor Valve	SC2337	Symmetric diverter "Y" valve	\$2,450.00
Rearward deflector kit	SC2335	Deflector for Bauer connector	\$1,418.00
Dust Suppression			
Tailgate Mesh	SC2230	Fine Mesh For Tailgate	Std.
Dust seal kit	SC2254	Drum/Backplate seal kit, including brush	Std.
Liquid Spray Kit	SC2350	Tank, power lead enclosure, hose and nozzles for booster fan	\$3,850.00



Dust Suppression Spray Kit



Asymmetric Divertor Valve

PRICED IN CANADIAN DOLLARS
PRICES ARE FOB HARRISTON, ONT. IN CDN DOLLARS – DESIGN & PRICE ARE SUBJECT TO CHANGE WITHOUT NOTICE
 Our right of continuous improvement has been implemented without prior notification. It does not constitute that these improvements and changes were applied to end user, retailing dealer or distributor inventory. Product improvements will apply only as production schedules permit. All dimensions are approximate.

Teagle Tomahawk 500FS (Feed Slide)

Description See T505M / T5050 with the following benefits: <ul style="list-style-type: none"> Non-stop processing for high output up to 4 tons/hr Straightforward loading and removal of bale net / twine For round bales up to 5ft, or rectangular bales up to 4ft x 4ft x 8ft Feed slide cannot be retrofitted and is not available for T404M / T4040 	Specifications <ul style="list-style-type: none"> Wide Angle PTO Standard 3 Pt. Cat 2 / 3 **NEW** Drum flow control valve Standard Hydraulic control of feed slide angle Tractor 140hp (mounted) Tractor 80hp (trailed option) 3 hydraulic services required Weight : T505FSM 2778lbs / T5050FS 2980lbs 	
--------------------------------------------------------------------------------------------------------------------------------------------------------------------------------------------------------------------------------------------------------------------------------------------------------------------------------------------------------------------------------------------------------------------	-----------------------------------------------------------------------------------------------------------------------------------------------------------------------------------------------------------------------------------------------------------------------------------------------------------------------------------------------------------------------------------------------------	------------------------------------------------------------------------------------

Additional Information is available on the Teagle website

Item	Part Number	Description	Price
Base machine T505M	T505FSM	Tomahawk 505M with 1.85m drum and feed slide & hydraulic top link.	\$49,840.00
Base machine T5050	T5050FS	Tomahawk 5050 with 1.85m drum and feed slide & hydraulic top link	\$48,265.00
<i>Chute Options - See T5050</i>			
PTO Options			
6 Spline WAJ PTO	PTO8130	6 Spline Tractor End WAJ at Machine end	Std.
21 Spline WAJ PTO - in lieu		21 Spline Tractor End In Lieu of 6 Spline	\$438.00
Chute Options - See T505M / T5050			
Non-supply of RH Chute		For improved straw containment	\$525.00
Miscellaneous Options			
Hyd. Flow Control	SC1332	Control drum speed from ground level	Std.
Hydraulic Top Link	HTL	Hydraulic Top Link Cat 2/3 - with check valve	Std. \$1,575.00
Dust Suppression			
Dust seal kit	SC1996 + SC2254	Drum/Backplate seal kit, including brush	Std.
Liquid Spray Kit	SC2350 (+EC1038)	Tank, power lead enclosure, hose and nozzles (Power Lead and Junction Box depending on serial number)	\$3,850.00



Can be attached to Optional Trailed Chassis

PRICED IN CANADIAN DOLLARS

PRICES ARE FOB HARRISTON, ONT. IN CDN DOLLARS – DESIGN & PRICE ARE SUBJECT TO CHANGE WITHOUT NOTICE

Our right of continuous improvement has been implemented without prior notification. It does not constitute that these improvements and changes were applied to end user, retailing dealer or distributor inventory. Product improvements will apply only as production schedules permit. All dimensions are approximate.

Teagle **Tomahawk Trailed Chassis**

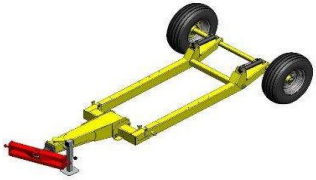
<p>Description A trailed chassis to fit all models of Drum Tomahawks. Recommended for smaller tractors or for improved maneuverability. · Not for Highway Use · Pivoting axle to set drum angle · Includes extension hydraulic hoses for Drum Tomahawk</p>	<p>Specifications · Lower Link Beam as Standard · Ring Hitch included · Check valves in hydraulic rams · 10.5x15 6 Stud Wheels and Tires · Weight 970lbs. · Tractor requires 1 x double acting service for chassis and 1 double acting for Tomahawk.</p>	
-----------------------------------------------------------------------------------------------------------------------------------------------------------------------------------------------------------------------------------------------------------------------------------	-----------------------------------------------------------------------------------------------------------------------------------------------------------------------------------------------------------------------------------------------------------------------------------------	-------------------------------------------------------------------------------------

Additional Information is available on the Teagle website

Item	Part Number	Description	Price
Base machine	RDC	Trailed Chassis for use with drum Machines	\$12,478.00
PTO Options			
6 Spline WAJ PTO - in lieu*	PTO8130	Upgrade the standard PTO to WAJ (at machine end)	\$1,505.00
6 Spline WAJ PTO - retrofit	PTO8130	Upgrade the standard PTO to WAJ (at machine end)	\$3,360.00



* must be ordered at same time as Drum Tomahawk. Note WAJ PTO standard with T500B.
Image shows T500B on trailed chassis



PRICED IN CANADIAN DOLLARS

PRICES ARE FOB HARRISTON, ONT. IN CDN DOLLARS – DESIGN & PRICE ARE SUBJECT TO CHANGE WITHOUT NOTICE

Our right of continuous improvement has been implemented without prior notification. It does not constitute that these improvements and changes were applied to end user, retailing dealer or distributor inventory. Product improvements will apply only as production schedules permit. All dimensions are approximate.

Teagle		Tomahawk 500E (Electric Drive)	
Description No tractor required. Convenient operation with stationary machine Fits Tomahawk 500 series models Intuitive electronic controls with load monitoring Sequenced rotor and drum speed Robust subframe for machine and main drive		Specifications Two rotor motor size options Dust seal kit standard Inverter control system Control cabinet included	
			
Additional Information is available on the Teagle website			
Item	Part Number	Description	Price
Base machine	T505M	Tomahawk 505M with 1.55m drum - configured for electric	\$31,378.00
Rotor / Screen Options - See T505M - Please specify screen size and Hammer/Blade rotor at time of ordering			
Dust Supression			
Dust seal kit	SC1996 + SC2254	Drum/Backplate seal kit, including brush	Std.
Liquid Spray Kit	SC2350	Tank, power lead enclosure, hose and nozzles (Power Lead and Junction Box depending on serial number)	\$3,850.00
Chute Options - See T505M			
Motor Options			
45kW DC motor	EDS45	45kW electric rotor drive motor complete with control cabinet	\$77,980.00
55kW DC motor	EDS55	55kW electric rotor drive motor complete with control cabinet	\$81,515.00
Booster fan Option			
Booster fan with electric	EDS BOOSTER	Booster fan, 11kW electric Motor, 127mm hose adaptor	\$22,208.00
Feed Conveyor Options			
First feed conveyor	EDS CONV1	3m feed conveyor attached to drum incl. 1.5kW el. motor	\$21,368.00
Additional feed conveyor	EDS CONV2	3m feed conveyor attached to prev. conveyor incl. 1.5kW el. motor	\$19,495.00
MUST COMPLETE QUESTIONNAIRE - CONTACT HARCO AG OR SEE OUR WEBSITE UNDER TEAGLE PRICE LIST FOR A COPY			
			

PRICED IN CANADIAN DOLLARS

PRICES ARE FOB HARRISTON, ONT. IN CDN DOLLARS – DESIGN & PRICE ARE SUBJECT TO CHANGE WITHOUT NOTICE

Our right of continuous improvement has been implemented without prior notification. It does not constitute that these improvements and changes were applied to end user, retailing dealer or distributor inventory. Product improvements will apply only as production schedules permit. All dimensions are approximate.

Teagle Tomahawk C12

Description High Capacity bale processor for precision milling of dry materials such as straw for livestock feeding and bedding. · 6.5ft Diameter Round Bales · 4ft. x 4ft x 8ft Rectangular Bales · Suitable for Dry Materials <20% moisture content · Includes 6 quick change screens · Auto Greasing System	Specifications · Trailed Machine with air/ hyd. brakes · Shear Bolt & Overrun Clutch PTO 1000rpm · Clevis Hitch Drawbar · Road Lights · Bluetooth Electric Controls · Homologated to 25 mph · Min PTO 180HP · Weight 9240 lbs.	
---------------------------------------------------------------------------------------------------------------------------------------------------------------------------------------------------------------------------------------------------------------------------------------------------------------------------------------------	-------------------------------------------------------------------------------------------------------------------------------------------------------------------------------------------------------------------------------------------------------------------	-------------------------------------------------------------------------------------

Additional Information is available on the Teagle website

Item	Part Number	Description	Price
Base machine	C12	Tomahawk C12 High Capacity Bale Processor (incl. 40 gallons hydraulic oil). Auto Greasing Kit.	\$180,822.00

Rotor Options			
Screen Sizes	Part Number	Description	Price
Six screens supplied with machine - Please specify which sizes are to be supplied at time of machine order - additional screens prices indicated here.	CM2366	4-15/16s" 125mm Screen	REFER TO C120 FOR PRICING ON PAGE 38 
	CM2072	3-15/16ths." 100mm Screen	
	CM2073	2-15/16ths." 75mm Screen	
	CM2074	2-3/8ths." 60mm Screen	
	CM2079	2" 50 mm Screen	
	CM2075	1-9/16ths" 40mm Screen	
	CM2076	1-3/16ths." 30mm Screen	
	CM2077	13/16ths." 20mm Screen	
	CM2361	1/2" 13mm Screen	
	CM2373	3/8ths." 10mm Screen	
	CM2078	5/16th" 8mm Screen	
	CM2376	1/4" 6mm Screen - For grain milling hopper	
	CM2374	3/16th" 5mm Screen - For grain milling hopper	
	CM2080	5/32nd". 4mm Screen - For grain milling hopper	
	CM2375	1/8th." 3mm Screen - For grain milling hopper	

PTO Options			
21 Spline PTO - in lieu	PTO8142	21 Spline Tractor End In Lieu of 6 Spline	

Highway / Trailed Options			
Road Lights	SC4269	LED Road Light Kit	
Jack	CM2545	Manual Hydraulic Drawbar Jack	
Brake System Air & Hyd.	CM2340	Combined Optional Brake system, Air & Hydraulic, in lieu of Air Only	
C-Type Air Brake Coupling	TB1155	Standard C-Type Coupling	
Palm Type Air Brake	TB1156	Palm type in-lieu of C-Type	
K80 Hitch	SC5018	K80 Ball Hitch in Lieu of standard ring hitch	
Clevis Hitch	SC5051	Clevis Hitch in Lieu of ring hitch - (not homologated)	

Miscellaneous Options			
Conveyor Deflector	CM2143	Deflector to control discharge of material from conveyor	
Oil heater	EC2017 + EC2018	Hydraulic tank oil heater	
Low temperature conveyor	SC2377	Extend min. operating temperature	

Hopper - not including scree	GMH	Hopper for grain milling - capacity 1350lbs (Barley). Does not include screens. Select 2 from the list above.	
Hopper Extensions	CM3040	Increase capacity to 2400lbs. Bucket opening width from 96" to 106".	



Grain Milling Hopper



NEW : Auto Greasing System as Standard

PRICED IN CANADIAN DOLLARS

PRICES ARE FOB HARRISTON, ONT. IN CDN DOLLARS – DESIGN & PRICE ARE SUBJECT TO CHANGE WITHOUT NOTICE

Our right of continuous improvement has been implemented without prior notification. It does not constitute that these improvements and changes were applied to end user, retailing dealer or distributor inventory. Product improvements will apply only as production schedules permit. All dimensions are approximate.

Teagle		Tomahawk C120	
Description High Capacity bale processor for precision milling of dry materials such as straw for livestock feeding and bedding. <ul style="list-style-type: none"> · 6.5ft Diameter Round Bales · 4ft. x 4ft x 8ft Rectangular Bales · Suitable for Dry Materials <20% moisture content · Includes 6 quick change screens · Auto Greasing System 		Specifications <ul style="list-style-type: none"> · Trailed Machine with air/ hyd. brakes · Shear Bolt & Overrun Clutch PTO 1000rpm · Clevis Hitch Drawbar & Jack · Road Lights · Bluetooth Electric Controls · Homologated to 40 kmph · Min PTO 180HP · Weight 12125 lbs. 	
			
Additional Information is available on the Teagle website			
Item	Part Number	Description	Price
Base machine	C120	Tomahawk C120 High Capacity Bale Processor (incl. 40 gallons hydraulic oil). Auto Greasing Kit.	\$234,500.00
Mill Screen Options - 6 screens included with machine, specify when ordering.			
Screen Sizes Six screens supplied with machine - Please specify which sizes are to be supplied at time of machine order - additional screens prices indicated here.	CM2365	4-15/16s" 125mm Slotted Screen	\$1,033.00
	CM2366	4-15/16s" 125mm Screen	\$1,033.00
	CM2072	3-15/16ths." 100mm Screen	\$1,033.00
	CM2073	2-15/16ths." 75mm Screen	\$1,033.00
	CM2074	2-3/8ths." 60mm Screen	\$1,033.00
	CM2079	2" 50 mm Screen	\$1,470.00
	CM2075	1-9/16ths" 40mm Screen	\$1,470.00
	CM2076	1-3/16ths." 30mm Screen	\$1,470.00
	CM2077	13/16ths." 20mm Screen	\$1,470.00
	CM2361	1/2" 13mm Screen	\$1,715.00
	CM2373	3/8ths." 10mm Screen	\$1,715.00
	CM2078	5/16th" 8mm Screen	\$1,890.00
	CM2376	1/4" 6mm Screen - For grain milling hopper	\$1,890.00
	CM2374	3/16th" 5mm Screen - For grain milling hopper	\$1,890.00
	CM2080	5/32nd". 4mm Screen - For grain milling hopper	\$1,890.00
	CM2375	1/8th" 3mm Screen - For grain milling hopper	\$1,890.00
	CM2378	5/32nd" 4mm Slotted Screen - For grain milling hopper	\$1,890.00
CM2379	1/8th" 3mm Slotted Screen - For grain milling hopper	\$1,890.00	
Adjustable Bale restraint		Adjustable bale restraint (bolted) to allow operator to optimise output for different materials.	Std.
PTO Options			
6 Spline PTO	PTO8140	6 Spline Tractor End	Std.
21 Spline PTO - in lieu	PTO8142	21 Spline Tractor End In Lieu of 6 Spline	\$490.00
20 Spline PTO - in lieu	PTO8140 +	20 Spline Tractor End In Lieu of 6 Spline	\$1,155.00
Highway / Trailed Options			
Road Lights	SC4269	LED Road Light Kit	Std.
Jack	CM2545	Hydraulic Drawbar Jack Powered by Tractor Aux.	Std.
Brake System Air & Hyd.	CM2340	Combined Brake system, Air & Hydraulic,	Std.
C-Type Air Brake Coupling	TB1155	Standard C-Type Coupling	Std.
Palm Type Air Brake Coupling	TB1156	Palm type in-lieu of C-Type	\$0.00
K80 Hitch	SC5018	K80 Ball Hitch in Lieu of standard ring / clevis hitch	\$333.00
Clevis Hitch	SC5051	Clevis Hitch in Lieu of ring hitch - (not homologated)	Std.
Miscellaneous Options			
Conveyor Deflector	CM2143	Deflector to control discharge of material from conveyor	\$1,435.00
Oil heater	EC2017 + EC2018	Hydraulic tank oil heater for 110V	\$1,260.00
Low temperature conveyor	CM3122 +CM3162	Extend min. operating temperature Below -22deg F (-30deg C)	\$3,745.00
Grain Milling Hopper			
Hopper - not including screens	GMH120	Grain Milling Hopper - capacity 85 Bushel. Does not include screens. Select at least 2 from the list above.	\$20,125.00
Non-homologated options - not available UK & EUR			
Tub - fixed in lieu of folding sides*	CM2321	Bolted infill panels for the tub - in lieu of folding	-\$1,050.00
Combined Air Hydraulic brakes*	CM2349	Additional hydraulic lines for braking	\$525.00
Hydraulic brakes only*	CM2342	Non-supply of air brake kit	-\$700.00
Non-supply of wheels / mudguards		Steel transport wheels in lieu of wheels/mudguards	-\$1,575.00

PRICED IN CANADIAN DOLLARS

PRICES ARE FOB HARRISTON, ONT. IN CDN DOLLARS – DESIGN & PRICE ARE SUBJECT TO CHANGE WITHOUT NOTICE







Our right of continuous improvement has been implemented without prior notification. It does not constitute that these improvements and changes were applied to end user, retailing dealer or distributor inventory. Product improvements will apply only as production schedules permit. All dimensions are approximate.

Teagle TOMAHAWK 6100H

Description · Spread bales of straw using a Telehandler / Tractor · Hydraulic Folding Bale Clamp Opt. · Stop / Start Fan Control · Max. 5' Diameter Round Bales · Half a 4' x 4' x 8' Rectangular Bale · Suitable for Straw and dry materials · Max. Spreading distance 40' · NO PTO REQUIRED!	Specifications · Minimum handler capacity 1.4 tons · Minimum handler oil flow 40 I/min (10.5 gal/min). Improve performance at 50I/min (13.2gal/min) · Minimum handler oil pressure 160 bar (2320psi) · Bluetooth Electric Controls · Weight without brackets : 1713/1892 lbs without/with bale clamp.	
----------------------------------------------------------------------------------------------------------------------------------------------------------------------------------------------------------------------------------------------------------------------------------------------------------------------------------------------------	-----------------------------------------------------------------------------------------------------------------------------------------------------------------------------------------------------------------------------------------------------------------------------------------------------------------------------	-------------------------------------------------------------------------------------



Additional Information is available on the Teagle website

Item	Part Number	Description	Price
Base machine	T6100H **NEW**	Tomahawk 6100H - Hydraulic drive straw spreader	\$37,048.00
Hydraulic Bale Clamp	SC6540	Bale Clamp in lieu of chain to retain bale (WiFi control)	\$2,625.00
Skidsteer Mounting Bracket			
Skidsteer Bracket	SC6220	Skidsteer KIT including mounting brackets	\$1,663.00
Tractor Mounting Bracket			
Tractor Bracket	SC6215	Category 2/3 Bracket for Tractor	\$2,100.00
Hydraulic Top Link	HTL	Hydraulic Top Link Cat 2/3 - with check valve	\$1,575.00
Handler Mounting Brackets			
See T6200 Specifications			
Miscellaneous Options			
Side Extensions	SC6550	For extra capacity	\$1,050.00
Hvd. Oil Filter	SC6565	In Line Hydraulic Pressure Filter	Std.

<p>Tractor Front Loader</p>  <p>Tractor-Front Loader or 3 Point Hitch</p>  <p>Skidsteer</p> 	<p>Bale Clamp</p>  <p>Side Extensions</p>  <p>Brackets</p> 
----------------------------------------------------------------------------------------------------------------------------------------------------------------------------------------------------------------------------------------------------------------------------------------------------------------------------------------------------------------------------	-------------------------------------------------------------------------------------------------------------------------------------------------------------------------------------------------------------------------------------------------------------------------------------------------------------------------------------------------

A 3/4" freeflow return fitted to the handler using flat face fittings is recommended for best performance. These items are not available from Teagle and are dealer fit.

PRICED IN CANADIAN DOLLARS
PRICES ARE FOB HARRISTON, ONT. IN CDN DOLLARS – DESIGN & PRICE ARE SUBJECT TO CHANGE WITHOUT NOTICE
 Our right of continuous improvement has been implemented without prior notification. It does not constitute that these improvements and changes were applied to end user, retailing dealer or distributor inventory. Product improvements will apply only as production schedules permit. All dimensions are approximate.

Teagle		TOMAHAWK 6200H	
Description · Spread bales of straw using a Telehandler / Tractor · Upgraded crossbeater driveline · Hydraulic Folding Loading Gate Std. · Stop / Start Fan Control · Max. 5 ft. Diameter Round Bales · 4 ft x 4 ft x 8 ft Rectangular Bales · Suitable for Straw and dry materials · Max. Spreading distance 44 ft. · NO PTO REQUIRED!		Specifications · Minimum handler capacity 2.8 tons · Minimum handler oil flow 60 I/min (13.3 gal/min) · Minimum handler oil pressure 160 bar (2320psi) · Bluetooth Electric Controls · Weight 3219 lbs (without brackets)	
			
Additional Information is available on the Teagle website			
Item	Part Number	Description	Price
Base machine	T6200H	Tomahawk 6200H - Hydraulic drive straw spreader	\$53,638.00
Tractor Mounting Bracket			
Tractor Bracket	SC6215	Category 2/3 Bracket for Tractor	\$2,100.00
Handler Mounting Brackets			
Please verify brackets with Teagle before ordering. Engineering drawings available for reference.	SC6001	JCB Q fit	\$1,470.00
	SC6005	Merlo ZM2 P26/27/30	
	SC6010	JCB / / Matbro / John Deere Pin and Cone	
	SC6015	Manitou	
	SC6020	New Holland	
	SC6025	Claas Scorpion (Dark Grey), also Kramer Telescopic	
	SC6030	Caterpillar Telescopic after Sept 2000 TH337C/226C	
	SC6035	Claas Scorpion (Light Grey Older Models)	
	SC6040	JCB Tool Carrier	
	SC6045	JCB Compact Toolcarrier	
	SC6050	Dieci	
	SC6055	Kramer older models 380, 412, 516, 520, 620, 712	
	SC6060	Volvo	
	SC6065	Bobcat / Massey 8925, 8926	
	SC6070	Euro 8	
	SC6090	Merlo ZM3	
	SC6095	Terex	
SC6200	Weideman		
SC6210	Atlas		
SC6220	Skidsteer		
Highway / Trailed Options			
Road Lights	SC6275	LED Road Light Kit incl. number plate bracket and light + EC1123	\$1,225.00
Miscellaneous Options			
Tailgate Switch	SC6276	In lieu of hydraulic loading gate - specify at time of ordering	\$875.00
Crossbeater Hooks / Blades	N/A	Specify hooks / blades (SC1100) at time of ordering.	\$0.00
Hyd. Oil Filter	SC6153	In Line Hydraulic Pressure Filter	\$1,173.00
Hydraulic Flow Divider and Oil Filter (combined)	SC6157	Req. for Hyd oil flows over 120 I/min (26.6 gal/min) / 270 bar 3915psi @ 80 ° (176 °F)	\$1,873.00
Ski Jump Chute Kit - Hydraulic Control	SC6277	For SC models to deliver straw into calf hutches and pig arcs or under trees. Includes extended yellow beak. Includes hydraulic control of chute angle (separate hydraulic service required).	\$2,275.00
A 3/4" freeflow return must be fitted to the handler using flat face fittings. These items are not available from Teagle and are Dealer Fit.			
			

PRICED IN CANADIAN DOLLARS

PRICES ARE FOB HARRISTON, ONT. IN CDN DOLLARS – DESIGN & PRICE ARE SUBJECT TO CHANGE WITHOUT NOTICE

Our right of continuous improvement has been implemented without prior notification. It does not constitute that these improvements and changes were applied to end user, retailing dealer or distributor inventory. Product improvements will apply only as production schedules permit. All dimensions are approximate.

Teagle Tomahawk 8200

Description Spread bales of straw for bedding or shred silage for feeding applications. · 6ft. 6inch Diameter Round Bales · 4ft x 4ft x 8ft Rectangular Bales · Suitable for Straw, Hay and Silage · Max. Spreading distance >65ft	Specifications · Mounted or Trailed · Slip & Overrun Clutch PTO · Rear Tailgate Switch · Bluetooth Electric Controls · 2 speed Gearbox - 540 RPM PTO · PTO req. min. 60hp/45kW Trailer PTO req. min. 140hp Mounted · Weight > 4600 lbs. · Standard wheels 10.0/75-15	 (also available in trailed format)
-----------------------------------------------------------------------------------------------------------------------------------------------------------------------------------------------------------------------------------------------------------------	--------------------------------------------------------------------------------------------------------------------------------------------------------------------------------------------------------------------------------------------------------------------------------------------------------	---------------------------------------------------------------------------------------------------------------------------

Additional Information is available on the Teagle website

Item	Part Number	Description	Price
Base machine	T8200M	T8200 Swivel Chute - fixed bale restraint - 3 point mounted	\$57,770.00
	T8200T	T8200 Swivel chute - fixed bale restraint - Trailed (unbraked)	\$62,146.00
	T8200SM	T8200 Swivel Chute - SYNCHRO Control - 3 point mounted	\$60,654.00
	T8200ST	T8200 Swivel chute - SYNCHRO Control - Trailed (unbraked)	\$65,030.00
PTO Options			
6 Spline WAJ PTO - in	PTO8085	6 Spline Tractor End, WAJ at Machine end	\$1,400.00
Highway / Trailed Options			
Road Lights	SC7120	Optional for Mounted LED Road Light Kit with EC1123 Standard Equipment with Trailed Machine with EC1123	\$1,225.00 Std.
Jack	SC7147	Drawbar Jack	Std.
Clevis Hitch	SC5051	Clevis Hitch in Lieu of Standard Ring Hitch	Std.
Crossbeater Options			
Extra Blade Kit	SC3768	For Standard Staw / Silage Crossbeater (Additional 48 blades)	\$543.00
Hook Ripper Kit	SC7138	Increased Feed Rate Less chopping Standard Straw/ Silage Crossbeater	\$350.00
Miscellaneous Options			
Hyd. Oil Filter	SC7145	In Line Hydraulic Pressure Filter	Std.
Automatic Chain Oiler	SC7140	Automatically lubricates crossbeater drive chain	\$1,523.00
Ski Jump Chute Kit	SC7205	For SC models to deliver straw into calf hutches and pig arcs or under trees. Includes extended yellow beak.	\$2,275.00
Dust Supression Kit	SC7150	High Pressure water spray to reduce dust	\$3,850.00

SYNCHRO : Our latest development!
 Adjust processing speed with adjustable bale restraint Start/Stop operation
 Linked bed speed / bale restraint position



PRICED IN CANADIAN DOLLARS

PRICES ARE FOB HARRISTON, ONT. IN CDN DOLLARS – DESIGN & PRICE ARE SUBJECT TO CHANGE WITHOUT NOTICE

Our right of continuous improvement has been implemented without prior notification. It does not constitute that these improvements and changes were applied to end user, retailing dealer or distributor inventory. Product improvements will apply only as production schedules permit. All dimensions are approximate.

Teagle Tomahawk 8250 Dual Chop

Description Spread bales of straw for bedding or shred silage for feeding applications. · 6ft. 6inch Diameter Round Bales · 4ft x 4ft x 8ft Rectangular Bales · Suitable for Straw & dry material only · Max. Spreading distance >65ft	Specifications · Mounted or Trailed · Slip & Overrun Clutch PTO · Rear Tailgate Switch · Bluetooth Electric Controls · 2 speed Gearbox - 540 RPM PTO · PTO req. min. 80 hp Trailed PTO req. min 150 hp Mounted · Weight > 4600 lbs. · Standard wheels 10.0/75-15	 <p>(also available in trailed format)</p>
-------------------------------------------------------------------------------------------------------------------------------------------------------------------------------------------------------------------------------------------------------------------------	----------------------------------------------------------------------------------------------------------------------------------------------------------------------------------------------------------------------------------------------------------------------------------------------------	-------------------------------------------------------------------------------------------------------------------------------

Additional Information is available on the Teagle website

Item	Part Number	Description	Price
Base machine	T8250SM	T8250 Swivel Chute - 3 point mounted	\$66,458.00
	T8250ST	T8250 Swivel chute - Trailed (unbraked)	\$78,106.00
PTO Options			
6 Spline WAJ PTO - in	PTO8085	6 Spline Tractor End, WAJ at Machine end	\$1,400.00
Highway / Trailed Options			
Road Lights	SC7120	Optional for Mounted LED Road Light Kit with EC1123 Standard Equipment with Trailed Machine with EC1123	\$1,225.00 Std.
Jack	SC7147	Drawbar Jack	Std.
Clevis Hitch	SC5051	Clevis Hitch in Lieu of Standard Ring Hitch	Std.
Miscellaneous Options			
Hyd. Oil Filter	SC7145	In Line Hydraulic Pressure Filter	Std.
Automatic Chain Oiler	SC7140	Automatically lubricates crossbeater drive chain	Std.
Ski Jump Chute Kit	SC7205	For SC models to deliver straw into calf hutches and pig arcs or under	\$2,275.00
Dust Suppression Kit	SC7150	High Pressure water spray to reduce dust	\$3,850.00

SYNCHRO : Our latest development!
 Adjust processing speed with adjustable bale restraint Start/Stop operation
 Linked bed speed / bale restraint position



PRICED IN CANADIAN DOLLARS

PRICES ARE FOB HARRISTON, ONT. IN CDN DOLLARS – DESIGN & PRICE ARE SUBJECT TO CHANGE WITHOUT NOTICE
 Our right of continuous improvement has been implemented without prior notification. It does not constitute that these improvements and changes were applied to end user, retailing dealer or distributor inventory. Product improvements will apply only as production schedules permit. All dimensions are approximate.

Teagle Tomahawk 8500 CHIEF

Description Spread bales of straw for bedding or shred silage for feeding applications. Wide body for easier loading and greater performance <ul style="list-style-type: none"> · 6ft. Diameter x 5ft width Round Bales · 4ft. x 4ft. x 8ft Rectangular Bales · Suitable for Straw, Hay and Silage · Max. Spreading distance 80ft. · Wear Resistant Steel Fan Housing 	Specifications <ul style="list-style-type: none"> · Trailed Machine · Slip & Overrun Clutch PTO · Rear Tailgate Switch · Bluetooth Electric Controls · 2 speed Gearbox - 540 RPM PTO · PTO req. min. 80hp · Weight 4586 / 4970lbs. · Standard wheels 12.5/75-15 	 <p>8500 CHIEF <small>BY HARDOX</small></p> <p>HARDOX <small>STEEL PLATE</small></p>
-------------------------------------------------------------------------------------------------------------------------------------------------------------------------------------------------------------------------------------------------------------------------------------------------------------------------------------------------------------------------------------------------------------------------------------------	----------------------------------------------------------------------------------------------------------------------------------------------------------------------------------------------------------------------------------------------------------------------------------------------------------------------------------------------------------	---------------------------------------------------------------------------------------------------------------------------------------------------------------------------------------------------

Additional Information is available on the Teagle website

Item	Part Number	Description	Price
Base machine	T8500 CHIEF	T8500 Side chute incl. lights/mudguards/extension sides/12.5 wheels	\$66,766.00
	T8500SC CHIEF	T8500SC Swivel chute incl. lights/mudguards/extension sides/12.5 wheels	\$67,939.00

PTO Options			
6 Spline WAJ PTO - in	PTO8085	6 Spline Tractor End, WAJ at Machine end	\$1,383.00

Highway / Trailed Options			
Road Lights	SC4270	LED Road Light Kit + EC1123	Std.
Wheels	WE1121	Tires and Rims 12.5/75 -15in .	Std.
Jack	SC4069	Drawbar Jack	Std.
Clevis Hitch	SC5051	Clevis Hitch and Jack in Lieu of Standard Ring Hitch	Std.

Crossbeater Options			
Extra Blade Kit	SC3768	For Standard Straw / Silage Crossbeater (Additional 48 blades)	\$543.00
Hook Ripper Kit	SC4218	Increased Feed Rate Less chopping Standard Straw/ Silage Crossbeater Only	\$333.00
Hardox Tips	SC4702	Crossbeater wear Tips - trianqular between knife rings	\$473.00

Miscellaneous Options			
Dust Sppression Kit	SC5410	5 Nozzle Water Spray Kit, 13 USG Capacity	\$3,745.00
Hyd. Oil Filter	SC4309	In Line Hydraulic Pressure Filter	Std.
Automatic Chain Oiler	SC5340	Automatically lubricates crossbeater drive chain	\$1,488.00
Side Extensions	SC4594	Increase bale chamber capacity	Std.
Tailgate Extension	SC4710	Extension for Increased Length +24"	\$1,348.00
Power Fly Lead	SC3598	Power Fly Lead with Female Socket	Std.
Rear Tailgate Switch	SC5241	Tailgate and Bed Control at Ground Level	Std.
Ski Jump Chute Kit - Hydraulic Control	SC5064	For SC models to deliver straw into calf hutches and pig arcs or under trees. Includes extended yellow beak.	\$2,275.00

PRICED IN CANADIAN DOLLARS

PRICES ARE FOB HARRISTON, ONT. IN CDN DOLLARS – DESIGN & PRICE ARE SUBJECT TO CHANGE WITHOUT NOTICE

Our right of continuous improvement has been implemented without prior notification. It does not constitute that these improvements and changes were applied to end user, retailing dealer or distributor inventory. Product improvements will apply only as production schedules permit. All dimensions are approximate.

5808 Hwy #9, Harriston, Ontario, N0G 1Z0
Phone: 519-338-2923, Fax: 519-338-2756
Email: sales@harcoag.ca, www.harcoag.ca

Teagle **Tomahawk 8555 CHIEF Dual Chop**

Description
Spread straw long or chop it short at the touch of a button. Suitable for cubicle bedding, TMR processing or bedding loose housing.
Removable screen now allows wet materials to be processed.
· 6ft. Diameter x 5ft width Round Bales
· 4ft. x 4ft. x 8ft Rectangular Bales
· Suitable for **Straw, Hay and Silage**
· Max. Spreading distance 80ft.
· Wear Resistant Steel Fan Housing

Specifications
· Trailed Machine
· Slip & Overrun Clutch PTO
· Rear Tailgate Switch
· Bluetooth Electric Controls
· 2 speed Gearbox - 540 RPM PTO
· PTO req. min. 80hp
· Weight 5340lbs.
· Standard wheels 12.5/75-15



Additional Information is available on the Teagle website

Item	Part Number	Description	Price
Base Machine	T8555 CHIEF	T8555SC Dual Chop Swivel chute incl. lights/mudguards/extension sides/chain oiler/12.5 wheels	\$82,639.00
Chopping System Options			
40mm Screen	SC5312	Standard specification 40mm screen supplied with 8555	Std.
50mm Screen	SC5310	Optional 50mm screen In lieu of std. 40mm screen	\$0.00
Additional screen		Select both 40mm and 50mm screens	\$1,190.00
Bypass screen	SC5314	Blanking screen required to process wet materials	\$840.00
Storage rack	SC5359	Screen rack (to store one screen under the machine)	\$840.00
402			
6 Spline WAJ PTO - in	PTO8085	6 Spline Tractor End, WAJ at Machine end	\$1,383.00
Highway / Trailed Options			
Road Lights	SC4270	LED Road Light Kit + EC1123	Std.
Wheels	WE1121	Tires and Rims 12.5/75 -15in .	Std.
Jack	SC4069	Drawbar Jack	Std.
Clevis Hitch	SC5051	Clevis Hitch and Jack in Lieu of Standard Ring Hitch	Std.
Miscellaneous Options			
Dust Sppression Kit	SC5410	5 Nozzle Water Spray Kit, 13 USG Capacity	\$3,745.00
Hyd. Oil Filter	SC4309	In Line Hydraulic Pressure Filter	Std.
Automatic Chain Oiler	SC5340	Automatically lubricates crossbeater drive chain	Std.
Side Extensions	SC4594	Increase bale chamber capacity	Std.
Tailgate Extension	SC4710	Extension for Increased Length +24"	\$648.00
Power Flv Lead	SC3598	Power Flv Lead with Female Socket	Std.
Rear Tailgate Switch	SC5241	Tailgate and Bed Control at Ground Level	Std.
Ski Jump Chute Kit - Hydraulic Control	SC5064	Material Delivery into Hutches. Inc Yellow Beak	\$2,275.00

PRICED IN CANADIAN DOLLARS

PRICES ARE FOB HARRISTON, ONT. IN CDN DOLLARS – DESIGN & PRICE ARE SUBJECT TO CHANGE WITHOUT NOTICE

Our right of continuous improvement has been implemented without prior notification. It does not constitute that these improvements and changes were applied to end user, retailing dealer or distributor inventory. Product improvements will apply only as production schedules permit. All dimensions are approximate.

Teagle **Tomahawk 9500**

Description
Spread bales of straw for bedding or shred silage for feeding applications.
Wide body for easier loading with twin crossbeaters for greater performance.
· 6ft. Diameter x 5ft width Round Bales
· 4ft. x 4ft. x 8ft Rectangular Bales
· Suitable for **Straw, Hay and Silage**
· Max. Spreading distance 80ft.
· Wear Resistant Steel Fan Housing

- Specifications**
- Trailed Machine
 - Slip & Overrun Clutch PTO
 - Rear Tailgate Switch
 - Bluetooth Electric Controls
 - 2 speed Gearbox - 540 RPM PTO
 - PTO req. min. 90hp
 - Weight 6650lbs.
 - Standard wheels 305/55 R22



Additional Information is available on the Teagle website

Item	Part Number	Description	Price
Base machine	T9500	T9500 Side chute incl. lights/mudguards	\$82,520.00
	T9500SC	T9500SC Swivel chute incl. lights/mudguards	\$83,692.00

PTO Options			
6 Spline WAJ PTO -	PTO8085	6 Spline Tractor End. WAJ at Machine end	\$1,400.00

Highway / Trailed Options			
Road Lights	SC5219	LED Road Light Kit + FC1123	Std.
Jack	SC4069	Drawbar Jack	Std.
Clevis Hitch	SC5051	Clevis Hitch and Jack in Lieu of Standard Ring Hitch	Std.

Crossbeater Options			
Hardox Tips	SC4702 x 2	Crossbeater wear Tips - triangular between knife rings	\$945.00

Miscellaneous Options			
Dust Sppression Kit	SC5410	5 Nozzle Water Spray Kit, 13 USG Capacity	\$3,745.00
Hyd. Oil Filter	SC4309	In Line Hydraulic Pressure Filter	Std.
Automatic Chain Oiler	SC5365	Automatically lubricates crossbeater drive chains	\$2,013.00
Swivel Chute Ext.	SC7029	Swivel Chute Lift Extension +12" supplied loose	\$998.00
Side Extensions	SC5261	For extended capacity	\$1,173.00
Tailgate Extension	SC4710	Extension for Increased Length +24"	\$998.00
Power Fly Lead	SC3598	Power Fly Lead with Female Socket	Std.
Rear Tailgate Switch	SC5241	Tailgate and Bed Control at Ground Level	Std.
Swivel Chute, Ski Jump Chute	SC5064	Material Delivery into Hutches. Inc Yellow Beak	\$2,275.00

9500 / 1010 Updated hinged hood



PRICED IN CANADIAN DOLLARS

PRICES ARE FOB HARRISTON, ONT. IN CDN DOLLARS – DESIGN & PRICE ARE SUBJECT TO CHANGE WITHOUT NOTICE

Our right of continuous improvement has been implemented without prior notification. It does not constitute that these improvements and changes were applied to end user, retailing dealer or distributor inventory. Product improvements will apply only as production schedules permit. All dimensions are approximate.

Teagle

Tomahawk 1010

Description Spread bales of straw for bedding or shred silage for feeding applications. Wide body for easier loading with twin crossbeaters for greater performance. • 5ft x 6ft Diameter Round Bales • 4ft. x 4ft. x 8ft Rectangular Bales • Suitable for Straw, Hay and Silage • Max. Spreading distance 80' • Wear Resistant Steel Fan Housing	Specifications • Trailed Machine with Hyd. Brakes • Slip & Overrun Clutch P.T.O. • Rear Tailgate Switch • Bluetooth Electric Controls • 2 speed Gearbox - 540 RPM PTO • PTO req. min. 90hp • Weight 7826 / 7915 lbs. • Standard wheels 385/55R22.5	
--------------------------------------------------------------------------------------------------------------------------------------------------------------------------------------------------------------------------------------------------------------------------------------------------------------------------------------------------------------------------------------	-----------------------------------------------------------------------------------------------------------------------------------------------------------------------------------------------------------------------------------------------------------------------------------	------------------------------------------------------------------------------------

Additional Information is available on the Teagle website

Item	Part Number	Description	Price
Base machine	T1010	T1010 Side chute incl. lights/brakes/mudguards/oil filter	\$98,602.00
	T1010SC	T1010SC Swivel chute incl. lights/mudguards/oil filter	\$99,775.00
6 Spline WAJ PTO -	PTO8085	6 Spline Tractor End. WAJ at Machine end	\$1,400.00
Highway / Trailed Options			
Road Lights	SC5270	LED Road Light Kit + FC1123	Std.
Jack	SC4069	Drawbar Jack	Std.
Clevis Hitch	SC5051	Clevis Hitch in Lieu of Standard Ring Hitch	Std.
Crossbeater Options			
Hardox Tips	SC4702 x 2	Crossbeater wear Tips - triangular between knife rings	\$945.00
Miscellaneous Options			
Bale Lift Plates	SC4902	Hyd. Cylinders & Mounting with Bale Lift Plates - Control box	\$7,508.00
Dust Spression Kit	SC5410	5 Nozzle Water Spray Kit, 13 USG Capacity	\$3,745.00
Power Fly Lead	SC3598	Power Fly Lead with Female Socket	Std.
Hyd. Oil Filter	SC4309	In Line Hydraulic Pressure Filter	Std.
Rear Tailgate Switch	SC5241	Tailgate and Bed Control at Ground Level	Std.
Automatic Chain	SC5365	Automatically lubricates crossbeater drive chains	\$2,013.00
Swivel Chute Ext.	SC7029	Swivel Chute Lift Extension +12" supplied loose	\$998.00
Side Extensions	SC4728	For extended capacity	\$1,278.00
Ski Jump Chute Kit - Hydraulic Control	SC5064	Material Delivery into Hutches. Inc Yellow Beak	\$2,275.00



Hydraulic Bale Lift Plates SC4902



PRICED IN CANADIAN DOLLARS

PRICES ARE FOB HARRISTON, ONT. IN CDN DOLLARS – DESIGN & PRICE ARE SUBJECT TO CHANGE WITHOUT NOTICE

Our right of continuous improvement has been implemented without prior notification. It does not constitute that these improvements and changes were applied to end user, retailing dealer or distributor inventory. Product improvements will apply only as production schedules permit. All dimensions are approximate.

Teagle **Spiromix 200H**

<p>Description</p> <ul style="list-style-type: none"> · A robust steel drum with auger flight offers unparalleled mixing action. Low Level Fill Height, and simple unloading by reversing drum rotation. · 110lbs of Cement 6:1 Mix · Min Tractor Size 50 HP · Hydraulic Drum Rotation controlled from tractor · Low maintenance drive · Parking Stands 	<p>Specifications</p> <ul style="list-style-type: none"> · 3 point hitch, category 1/2 · Drum volume 20cu.ft. · Approx. Mix Volume 10cu.ft. · Loading Height to drum lip 22" · Empty weight 420lbs · Laden weight 1790lbs · Drum Diameter 32" · Drum Length 43" 	
----------------------------------------------------------------------------------------------------------------------------------------------------------------------------------------------------------------------------------------------------------------------------------------------------------------------------------------------------------------------------------------------------------------------------	------------------------------------------------------------------------------------------------------------------------------------------------------------------------------------------------------------------------------------------------------------------------------------------------------------------------------------------------------	-------------------------------------------------------------------------------------

Additional Information is available on the Teagle website

Item	Part Number	Description	Price
Base machine	SPIRO200H	Spiromix Concrete Mixer	\$6,003.00



PRICED IN CANADIAN DOLLARS

PRICES ARE FOB HARRISTON, ONT. IN CDN DOLLARS – DESIGN & PRICE ARE SUBJECT TO CHANGE WITHOUT NOTICE

Our right of continuous improvement has been implemented without prior notification. It does not constitute that these improvements and changes were applied to end user, retailing dealer or distributor inventory. Product improvements will apply only as production schedules permit. All dimensions are approximate.

Teagle **XT20**

<p>Description</p> <p>Straightforward spreading up to 40ft. from a single disc spreader.</p> <p>Professional finish - Powder coated with stainless steel spreading components.</p> <p>Straightforward setup - simple rate and pattern adjustment.</p> <p>Easy to clean - removable flexible plastic hopper.</p>	<p>Specifications</p> <ul style="list-style-type: none"> · Bout Width : Up to 40ft. · Capacity : 23.5cu.ft · 3 point hitch, category 1/2 · S/S Hopper Sieve Standard · Loading Height 46" · Empty weight 265lbs. 	
------------------------------------------------------------------------------------------------------------------------------------------------------------------------------------------------------------------------------------------------------------------------------------------------------------------------	-------------------------------------------------------------------------------------------------------------------------------------------------------------------------------------------------------------------------------------------------------------------------------------	-------------------------------------------------------------------------------------

Additional Information is available on the Teagle website

Item	Part Number	Description	Price
Base machine	XT20	Single Disc Fertilizer Spreader	\$5,436.00

Skid Steer Options

Remote shutter	MB2923	Hydraulic Remote Shutter Control	\$928.00
Hopper Cover	MB2924	Hopper Cover	\$648.00

PRICED IN CANADIAN DOLLARS

PRICES ARE FOB HARRISTON, ONT. IN CDN DOLLARS – DESIGN & PRICE ARE SUBJECT TO CHANGE WITHOUT NOTICE

Our right of continuous improvement has been implemented without prior notification. It does not constitute that these improvements and changes were applied to end user, retailing dealer or distributor inventory. Product improvements will apply only as production schedules permit. All dimensions are approximate.

Teagle XT24 & XT48

<p>Description Straightforward spreading up to 40ft. with a reliable quadruple overlap spread pattern. Tilt boundary spreading system. Professional finish - Powder coated with stainless steel spreading components and tractor guard **NEW** Straightforward setup - simple rate and pattern adjustment</p>	<p>Specifications</p> <ul style="list-style-type: none"> · Bout Width : Up to 40ft. · 3 point hitch, category 1/2 · S/S Hopper Sieve Standard · Capacity XT24 : 1400lbs. · Capacity XT48 : 2950lbs. · Empty weight XT24 : 408lbs. · Empty weight XT48 : 597lbs. 	
-------------------------------------------------------------------------------------------------------------------------------------------------------------------------------------------------------------------------------------------------------------------------------------------------------------------------------------------------------------------------------------------------	---------------------------------------------------------------------------------------------------------------------------------------------------------------------------------------------------------------------------------------------------------------------------------------------------------------------------------------------	------------------------------------------------------------------------------------

Additional Information is available on the Teagle website

Item	Part Number	Description	Price
Base machine	XT24	Twin Disc Fertilizer Spreader with hydraulic shutter control and hopper sieve :1400lbs	\$8,439.00
Base machine	XT24B	As above but with Band Spreading kit fitted	\$8,439.00

Options

Hydraulic Tilt Kit	MB3019	Hydraulic ram to control tilt from tractor cab	\$718.00
Hopper Cover	MB3016	Canvas Hopper Cover	\$613.00
Band Spreading Kit Unfitted	MB2264	Enables user to switch from standard to band spreading	\$385.00

Item	Part Number	Description	Price
Base machine	XT48	Twin Disc Fertilizer Spreader with hydraulic shutter control and hopper sieve : 2950lbs.	\$11,253.00
Base machine	XT48B	As above but with Band Spreading kit fitted	\$11,253.00

Options

Hydraulic Tilt Kit	MB3124	Hydraulic ram to control tilt from tractor cab	\$945.00
Hopper Cover	MB3125	Canvas Hopper Cover	\$735.00
Band Spreading Kit Unfitted	MB2264	Enables user to switch from standard to band spreading	\$385.00



PRICED IN CANADIAN DOLLARS

PRICES ARE FOB HARRISTON, ONT. IN CDN DOLLARS – DESIGN & PRICE ARE SUBJECT TO CHANGE WITHOUT NOTICE

Our right of continuous improvement has been implemented without prior notification. It does not constitute that these improvements and changes were applied to end user, retailing dealer or distributor inventory. Product improvements will apply only as production schedules permit. All dimensions are approximate.

Teagle

Superted 221

Description

A robust high speed swath conditioner to introduce air to a swath, reducing drying times and preserving crop condition.

- 7'3" Pickup Width / 9'6 Overall Width
- Castor Wheels 6.00/9 V50

Specifications

- 3 point hitch, category 2
- 540 rpm PTO
- Belt Drive Rotor
- Min Tractor Size 60 HP
- Weight 1540lbs.



Additional Information is available on the Teagle website

Item	Part Number	Description	Price
Base machine	TED221	Superted High Speed Swath Conditioner	\$20,227.00

PRICED IN CANADIAN DOLLARS

PRICES ARE FOB HARRISTON, ONT. IN CDN DOLLARS – DESIGN & PRICE ARE SUBJECT TO CHANGE WITHOUT NOTICE

Our right of continuous improvement has been implemented without prior notification. It does not constitute that these improvements and changes were applied to end user, retailing dealer or distributor inventory. Product improvements will apply only as production schedules permit. All dimensions are approximate.

Teagle

Titan 6/8/9

Description The TITAN range is well proportioned, ensuring excellent stability, maneuverability, visibility of the load, and superior ground clearance. · Titan 6: 215ft ³ Capacity · Titan 8: 280ft ³ Capacity · Titan 9: 320ft ³ Capacity Dual Vertical beaters for a fine spread pattern	Specifications · WAJ PTO as standard 540 rpm · Cam and Overrun Clutch PTO · Hyd. Braked Axle · Slurry Gate · Min PTO 80/90/100HP · Weight: 7452/8069/8554lbs.	
----------------------------------------------------------------------------------------------------------------------------------------------------------------------------------------------------------------------------------------------------------------------------------------------------------------------------------------------------	-----------------------------------------------------------------------------------------------------------------------------------------------------------------------------------------------	-------------------------------------------------------------------------------------

Additional Information is available on the Teagle website

Item	Part Number	Description	Price
Base machine	TN6	Titan 6 with rigid drawbar and ring hitch	\$80,850.00
	TN8	Titan 8 with rigid drawbar and ring hitch	\$83,423.00
	TN9	Titan 9 with rigid drawbar and ring hitch	\$84,711.00

Wheel Options			
TN6	WE1302	18.4-34 (1645 x 467)	Std.
TN8	WE1302	18.4-34 (1645 x 467)	Std.
TN9	WE1302	18.4-34 (1645 x 467)	Std.
Oversize Wheels			P.O.A

Extension sides			
TN6	RS4210	Increases capacity of Titan 6 to 263ft ³	\$1,540.00
TN8	RS5130	Increases capacity of Titan 8 to 345ft ³	\$1,680.00
TN9	RS5130	Increases capacity of Titan 9 to 387ft ³	\$1,680.00

Miscellaneous Options			
Compost beater tips	RS3079	Beater tips to improve performance with friable	\$1,365.00
Electric bed speed	RS4590	In Cab, Bed Chain Speed Controller	\$2,608.00
Hydraulic Jack	RS4270	Drawbar Jack	\$2,660.00
Flashing Beacon	RS4631	Strobe for Highway use	\$420.00

PRICED IN CANADIAN DOLLARS

PRICES ARE FOB HARRISTON, ONT. IN CDN DOLLARS – DESIGN & PRICE ARE SUBJECT TO CHANGE WITHOUT NOTICE

Our right of continuous improvement has been implemented without prior notification. It does not constitute that these improvements and changes were applied to end user, retailing dealer or distributor inventory. Product improvements will apply only as production schedules permit. All dimensions are approximate.

Teagle

Titan 10/12

Description The TITAN range is well proportioned, ensuring excellent stability, maneuverability, visibility of the load, and superior ground clearance. · Titan 10: 348ft ³ Capacity · Titan 12: 414ft ³ Capacity Rigid Drawbar as Standard Dual Vertical beaters for a fine spread pattern	Specifications · BORON Steel Beaters · WAJ PTO as standard 1000 rpm · Cam and Overrun Clutch PTO · Hyd. Braked Axle · Slurry Gate std. · Min PTO 100HP/120HP · Weight: 11486/12059lbs.	
-----------------------------------------------------------------------------------------------------------------------------------------------------------------------------------------------------------------------------------------------------------------------------------------------------------------------------------------	---------------------------------------------------------------------------------------------------------------------------------------------------------------------------------------------------------------------------	------------------------------------------------------------------------------------

Additional Information is available on the Teagle website

Item	Part Number	Description	Price
Base machine	TN10	Titan 10 with rigid drawbar and ring hitch	\$98,550.00
	TN12	Titan 12 with rigid drawbar and ring hitch	\$100,954.00

Drawbar Options			
Rigid Ring Drawbar	RS4699	Rigid Ring Drawbar	Std.
Sprung Ring Drawbar	RS4512	Sprung Ring Drawbar	\$2,107.00
Rigid Clevis Drawbar		Rigid Clevis Drawbar	\$0.00
Sprung Clevis Drawbar		Sprung Clevis Drawbar	\$2,107.00

Wheel Options			
TN10 / TN12	WE1309	580/70R38 (1852 x 580)	Std.
Oversize Wheels		Various Oversize wheel options available	P.O.A.

Braking Options			
Commercial Axle with Air & Hyd.		Air & Hydraulic braked axle with 4.8" x 15.8" drums	\$5,828.00
TN10	RS4510	Increases Capacity Titan 10 to 423ft ³	\$1,820.00
TN12	RS4610	Increases Capacity Titan 12 to 510ft ³	\$2,223.00

Miscellaneous Options			
Weighing Load Cell Kit	RS4697	Basic Weighing System (3 point)	\$10,448.00
Electric bed speed	RS4590	In-Cab Electric Bed Chain Speed Controller	\$2,608.00
Flashing Beacon	RS4631	Strobe for Highway use	\$420.00
Hydraulic Jack	RS4270	Drawbar Jack	\$2,660.00

PRICED IN CANADIAN DOLLARS

PRICES ARE FOB HARRISTON, ONT. IN CDN DOLLARS – DESIGN & PRICE ARE SUBJECT TO CHANGE WITHOUT NOTICE

Our right of continuous improvement has been implemented without prior notification. It does not constitute that these improvements and changes were applied to end user, retailing dealer or distributor inventory. Product improvements will apply only as production schedules permit. All dimensions are approximate.

Teagle Titan 15/17

Description The TITAN range is well proportioned, ensuring excellent stability, maneuverability, visibility of the load, and superior ground clearance. · Titan 15: 543ft ³ Capacity · Titan 17: 607ft ³ Capacity Sprung Drawbar as Standard Dual Vertical beaters for a fine spread pattern	Specifications · BORON Steel Beaters · WAJ PTO as standard 1000 rpm · Cam and Overrun Clutch PTO · Air / Hyd. Braked Axle Std. · Slurry Gate std. · Min PTO 120HP/160HP · Weight: 13845/14462lbs.	
------------------------------------------------------------------------------------------------------------------------------------------------------------------------------------------------------------------------------------------------------------------------------------------------------------------------------------------	--------------------------------------------------------------------------------------------------------------------------------------------------------------------------------------------------------------------------------------	------------------------------------------------------------------------------------

Additional Information is available on the Teagle website

Item	Part Number	Description	Price
Base machine	TN15	Titan 15 with rigid drawbar and ring hitch	\$128,478.00
	TN17	Titan 17 with rigid drawbar and ring hitch	\$133,819.00

Drawbar Options			
Sprung Clevis Drawbar		Sprung Clevis Drawbar	P.O.A.

Wheel Options			
TN15 / TN17	WE1309	580/70R38	Std.
Oversize Wheels		Various Oversize wheel options available	P.O.A.

Braking Options			
Commercial Axle with Air & Hyd.		Air & Hydraulic braked axle with 4.8" x 15.8"drums	Std.

Extension sides			
TN15		Increases Capacity Titan 15 to 634ft ³	\$2,258.00
TN17		Increases Capacity Titan 17 to 710ft ³	\$2,503.00

Miscellaneous Options			
Weighing Load Cell Kit	RS4697	Basic Weighing System (3 point)	\$10,448.00
Electric bed speed	RS4590	In-Cab Electric Bed Chain Speed Controller	\$2,608.00
Flashing Beacon	RS4631	Strobe for Highway use	Std.
Hydraulic Jack	RS4270	Drawbar Jack	\$2,660.00

PRICED IN CANADIAN DOLLARS

PRICES ARE FOB HARRISTON, ONT. IN CDN DOLLARS – DESIGN & PRICE ARE SUBJECT TO CHANGE WITHOUT NOTICE

Our right of continuous improvement has been implemented without prior notification. It does not constitute that these improvements and changes were applied to end user, retailing dealer or distributor inventory. Product improvements will apply only as production schedules permit. All dimensions are approximate.

Harco Ag Set-Up Charges

Harco Ag 'Set-Up' includes basic assembly only; machines are not considered field ready.
Final preparation for use is the dealer's responsibility.

Model	Estimated Time (Hours)	Price
Teagle 505M	0.5	\$50.00
Teagle 505B	1	\$100.00
Teagle 505XLM/5050XL	3.5	\$350.00
Teagle 500FS	3.5	\$350.00
Teagle 5050	0.5	\$50.00
Teagle 6100H	2	\$200.00
Teagle 6200H	2	\$200.00
Teagle 8200	2	\$200.00
Teagle 8250	2	\$200.00
Teagle 8500	2	\$200.00
Teagle 8555	2	\$200.00
Teagle 9500	3	\$300.00
Teagle 1010	6	\$600.00
Teagle C12	6	\$600.00
Teagle C120	6	\$600.00

Options	Estimate Time (Hours)	Price
Chute	0.5	\$50.00
Tailgate Mesh Kit	0.5	\$50.00
Dust Seal Kit	1.5	\$150.00
Liquid Spray Kit	3.75	\$375.00
New Screen	0.75	\$75.00
Bale Lifts	0.5	\$50.00

Please contact us for any set-up charges on any models/options not listed.

PRICED IN CANADIAN DOLLARS

PRICES ARE FOB HARRISTON, ONT. IN CDN DOLLARS – DESIGN & PRICE ARE SUBJECT TO CHANGE WITHOUT NOTICE

Our right of continuous improvement has been implemented without prior notification. It does not constitute that these improvements and changes were applied to end user, retailing dealer or distributor inventory. Product improvements will apply only as production schedules permit. All dimensions are approximate.

5808 Hwy #9, Harriston, Ontario, N0G 1Z0
Phone: 519-338-2923, Fax: 519-338-2756
Email: sales@harcoag.ca
www.harcoag.ca

BEDDING & MULCHING CHOPPERS



Bedding Choppers for Straw, Hay or Newspaper			
Model #	Description	Lbs.	Price (Cdn)
KB1255	Model KB 1000 side discharge chassis w/13 hp Honda engine & double swivel wheel	480	\$7,743.00
KB1275	Model KB 1000 side discharge chassis w/14 hp Vanguard engine & double swivel wheel	480	\$7,743.00
KB1280	Model KB1000 side discharge chassis w/5 hp electric motor & double swivel wheel	460	\$6,683.00

Bedding Choppers for use with TMR systems			
Model #	Description	Lbs.	Price (Cdn)
KB1560	Model KB 1500 Bottom discharge chassis with 76 knives, adjustable stand & 3 hp electric motor	485	\$5,950.00

Mulching Choppers for Landscaping			
Model #	Description	Lbs.	Price (Cdn)
KB1350	Model KB 1300 Blower chassis w/56 knives, 16 hp Briggs & Stratton Vanguard engine & stationary gooseneck for 6" hose.	650	\$11,206.00
KB1355	Model KB 1300 Blower chassis w/56 knives, 13 hp Honda engine & stationary gooseneck for 6" hose.	680	\$9,943.00
KB1390	Model KB 1300 Blower chassis w/56 knives, PTO drive, 3 point hitch & stationary gooseneck for 6" hose.	600	\$9,943.00

PRICED IN CANADIAN DOLLARS

PRICES ARE FOB HARRISTON, ONTARIO – DESIGN & PRICE ARE SUBJECT TO CHANGE WITHOUT NOTICE

5808 Hwy #9, Harriston, Ontario, N0G 1Z0
Phone: 519-338-2923, Fax: 519-338-2756
Email: sales@harcoag.ca
www.harcoag.ca

WEAVERLINE

MULCH BAGGERS//BLOWERS//ACCESSORIES



Mulch Bagger			
Model #	Description	Lbs.	Price (Cdn)
46MB	Mulch Bagger		\$14,234.00

Air Raid Debris Blower			
Model #	Description	Lbs.	Price (Cdn)
218	Air Raid Debris Blower		\$6,846.00

Options & Accessories for Landscaping			
Model #	Description	Lbs.	Price (Cdn)
KB1410	Stationary Gooseneck for 6" hose	18	\$660.00
KB1420	Short Rotating Gooseneck for 6" hose	20	\$970.00
KB1425	Tall Rotating Gooseneck for 6" hose	30	\$1,051.00
KB1415	30 feet of 6" blower hose	50	\$1,369.00
KB1416	40 feet of 6" blower hose	67	\$1,654.00
KB1417	Hose handle kit	5	\$179.00
KB1405	6" Blower hose per foot	2	\$46.00

PRICED IN CANADIAN DOLLARS

PRICES ARE FOB HARRISTON, ONTARIO – DESIGN & PRICE ARE SUBJECT TO CHANGE WITHOUT NOTICE

SILAGE CARTS



37 Bushel Cart – c/w 24V Charger (deduct \$1,051.00 if not required)

Model #	Description	Lbs.	Price (Cdn)
537SS4	537 Stainless Cart w/ 4 SS Augers & SS Conveyor		\$17,107.00
537DL	537 Stainless Cart w/ 4 SS Augers & 62 Detachable Chain		\$17,107.00

31 Bushel Cart – c/w 24V Charger (deduct \$1,051.00 if not required)

Model #	Description	Lbs.	Price (Cdn)
531SS4	531 Stainless Cart w/4 SS Augers & SS Conveyor		\$16,047.00
531SS2	531 Stainless Cart w/2 SS Augers & SS Conveyor		\$15,884.00
531DL	531 Stainless Cart w/4 SS Augers & 62 Detachable Chain		\$16,047.00

25 Bushel Cart – c/w 24V Charger (deduct \$1,051.00 if not required)

Model #	Description	Lbs.	Price (Cdn)
525SS4	525 Stainless Cart w/4 SS Augers & SS Conveyor		\$15,640.00
525SS2	525 Stainless Cart w/2 SS Augers & SS Conveyor		\$15,477.00
525DL	525 Stainless Cart w/4 SS Augers & 62 Detachable Chain		\$15,640.00

21 Bushel Cart– c/w 24V Charger (deduct \$1,051.00 if not required)

Model #	Description	Lbs.	Price (Cdn)
521SS4	521 Stainless Cart w/4 SS Augers & SS Conveyor		\$16,047.00
521SS2	521 Stainless Cart w/2 SS Augers & SS Conveyor		\$15,884.00
521DL	521 Stainless Cart w/4 SS Augers & 62 Detachable Chain		\$16,047.00

Options

Description	Price (Cdn)
24V Charger	\$1,051.00
High box (13" to 30" discharge)	\$1,263.00
Front & Side Unloading	\$1,141.00
Extra Heavy Duty Caster (Included on Model 527)	\$269.00
Air Tires (Outside) adds 6 1/2" to the width	\$530.00
Hay Special Cart – Use 4SS Auger Cart Price and add	\$831.00

Carts w/2 SS Augers have the lower 2 augers Stainless and the top 2 augers hot roll.

PRICED IN CANADIAN DOLLARS

PRICES ARE FOB HARRISTON, ONTARIO – DESIGN & PRICE ARE SUBJECT TO CHANGE WITHOUT NOTICE

TAB 5



5808 Hwy #9, Harriston, Ontario, N0G 1Z0
Phone: 519-338-2923, Fax: 519-338-2756
Email: sales@harcoag.ca
www.harcoag.ca

Date Change Only

TerraFormer (Earth Mover)

<p>Features Include:</p> <ul style="list-style-type: none"> ▪ Infinite blade adjustments from 12 to 28 feet. ▪ Under 12 foot transport width. ▪ Auto grade & auto slope ready. ▪ Hydraulic cylinder protection circuits. 	<p>Standard Equipment:</p> <ul style="list-style-type: none"> ▪ Hardened, industry standard cutting edges. ▪ Height & tilt indicator. ▪ Industrial cylinders. ▪ LED warning strobe package.
<p>Optional Equipment:</p> <ul style="list-style-type: none"> ▪ SD Drain autograde & slope control. ▪ Scraper style hitch. ▪ Electric over hydraulic multipliers or valves. ▪ Complete RTK systems. 	

Model #	Description	Weight	In Freight	MSRP [CDN]
886500	8650 – 11K# Ag Hitch, Six Hydraulic Functions			\$183,600.00
887001	Scraper Hitch Kit – Case/NH Pattern			\$5,347.00
887004	5 th Wheel Transport Hitch			\$3,087.00
887005	Hydraulic Valve Multiplier for 5 Valve Tractors			\$1,654.00
887006	Hydraulic Valve Multiplier for 4 Valve Tractors			\$3,308.00
887007	6 Electric Proportional Hydraulic Valve for Tractors w/Manual Valves			\$19,845.00
887100	SD Drain Wireless Machine Control Package (Grade Only)			\$18,191.00
887101	SD Drain Extreme Duty Wired Machine Control Package (Grade Only)			\$18,853.00
887105	DAC2x2 Slope Control Kit & Unlock for SD Drain			\$2,977.00
887200	ADMS Watershed Software w/1 year license & support			\$3,445.00
	Factory Set-up – Tow Configuration			\$4,725.00



PRICED IN CANADIAN DOLLARS

PRICES ARE FOB BENITO, MB – DESIGN & PRICE ARE SUBJECT TO CHANGE WITHOUT NOTICE

5808 Hwy #9, Harriston, Ontario, N0G 1Z0

Phone: 519-338-2923, Fax: 519-338-2756

 Email: sales@harcoag.ca
www.harcoag.ca

Easy Installation * Fully Adjustable * UV Stable ABS * Universal Bracket

Available in Black, Gray, Green, Orange and Red.

Eclipse Canopies will fit most utility vehicles, mowers and tractors equipped with ROPS bars with listed frame sizes.

Includes canopy & mounting hardware.

Hardware Options	ROPS	PITCH
Standard	2" x 2" & 3" x 2"	0 to 25 Degree
Oversized	4" x 2" & 4" x 3"	0 to 25 Degree
Extreme Pitched	2' x 2' & 3" x 2"	45 Degree

Universal TRACTOR Canopy – 4550 Series

Item #	Description	Fits ROPS Sizes	MSRP [CDN]
4550B	45" x 50" BLACK Canopy	2" x 2", 3" x 1½", 3" x 1¾" & 3" x 2" ROPS	\$993.00
4550Ba	BLACK Canopy	For angled ROPS	\$893.00
4550Y	45" x 50" GRAY Canopy	2" x 2", 3" x 1½", 3" x 1¾" & 3" x 2" ROPS	\$1114.00
4550Ya	GRAY Canopy	For angled ROPS	\$970.00
4550R	45" x 50" RED Canopy	2" x 2", 3" x 1½", 3" x 1¾" & 3" x 2" ROPS	\$1114.00
4550Ra	RED Canopy	For angled ROPS	\$970.00
4550G	45" x 50" GREEN Canopy	2" x 2", 3" x 1½", 3" x 1¾" & 3" x 2" ROPS	\$1114.00
4550Ga	GREEN Canopy	For angled ROPS	\$970.00
4550O	45" x 50" ORANGE Canopy	2" x 2", 3" x 1½", 3" x 1¾" & 3" x 2" ROPS	\$1114.00
*Being phased out – we have stock though!			

Universal MOWER Canopy – 3641 Series

Item #	Description	Fits ROPS Sizes	MSRP [CDN]
3641SB	36" x 41" BLACK Canopy	2" x 2", 3" x 1½", 3" x 1¾" & 3" x 2" ROPS	\$855.00
3641RB	36" x 41" BLACK Canopy	Fits 2½" Round ROPS	\$855.00
3641SY	36" x 41" GRAY Canopy	2" x 2", 3" x 1½", 3" x 1¾" & 3" x 2" ROPS	\$727.00
3641SG	36" x 41" GREEN Canopy	2" x 2", 3" x 1½", 3" x 1¾" & 3" x 2" ROPS	\$933.00
3641SO	36" x 41" ORANGE Canopy	2" x 2", 3" x 1½", 3" x 1¾" & 3" x 2" ROPS	\$933.00
3641SR	36" x 41" RED Canopy	2" x 2", 3" x 1½", 3" x 1¾" & 3" x 2" ROPS	\$993.00



Top Fan Powered

Item #	Description	MSRP [CDN]
C3641B	36" x 41" BLACK Canopy	\$1,679.00
C4351B	43 ¾" X 50 ½" BLACK Canopy	\$1,713.00
C4351G	43 ¾" X 50 ½" GREEN Canopy	\$1,935.00
C4351O	43 ¾" X 50 ½" ORANGE Canopy	\$1,935.00
C4351R	43 ¾" X 50 ½" RED Canopy	\$1,935.00
	Adapter Bar Kits	\$143.00

PRICED IN CANADIAN DOLLARS

PRICES ARE FOB HARRISTON, ONT – DESIGN & PRICE ARE SUBJECT TO CHANGE WITHOUT NOTICE

5808 Hwy #9, Harriston, Ontario, N0G 1Z0
Phone: 519-338-2923, Fax: 519-338-2756
Email: sales@harcoag.ca
www.harcoag.ca



Kubota RTV Canopy

Kubota RTV Canopy

Model #	Part #	Description	MSRP [CDN]
RTV-X900	K4860B1	Black Canopy	\$765.00
RTV-X1120D Diesel	K4860O1	Orange Canopy	\$765.00
RTV-XG850 Sidekick	K4860O1	Orange Canopy	\$765.00

Gator UV Canopy

Model #	Part #	Description	MSRP [CDN]
TOPS			
TS, TX, TE 4x2	JG21G	Top, frame & hardware kit	\$1,180.00
TH 6x4 Diesel	JG04G	Top, frame & hardware kit	\$1,180.00
TH 6x4 Gas	JG04G	Top, frame & hardware kit	\$1,180.00
2000 to 2003	JG03G	Top, frame & hardware kit	\$1,180.00
FRONT WINDSHIELD			
All T Gator Models	JG411A	Front windshield fits all units	\$407.00



John Deere Gator Canopy

All above includes canopy & mounting hardware

PRICED IN CANADIAN DOLLARS

PRICES ARE FOB HARRISTON, ONT – DESIGN & PRICE ARE SUBJECT TO CHANGE WITHOUT NOTICE



5808 Hwy #9, Harriston, Ontario, N0G 1Z0
 Phone: 519-338-2923, Fax: 519-338-2756
 Email: sales@harcoag.ca
www.harcoag.ca



Amended September 2025

PRICELIST

Model	Description	Price [CDN]
HWP-100	Processor w/2 way wedge	\$12,549.00
HWP-100	Processor w/4 way wedge	\$12,746.00
HWP-100	Processor w/2 way & 4 way wedge	\$13,061.00
HWP-120	Processor/Adjusts 4 way	\$18,634.00
HWP-120	Processor/Adjusts 6 way	\$18,981.00
HWP-140B	Processor/Adjusts 4 way	\$27,704.00
HWP-140B	Processor/Adjusts 6 way	\$28,051.00
HWP-150	Processor/Adjusts hydraulically 4 way	\$35,913.00
HWP-150	Processor/Adjusts hydraulically 6 way	\$36,267.00
HWP-160	Processor w/4 way wedge	\$57,209.00
HWP-160	Processor w/6 way wedge	\$57,524.00
HWP-160	Processor w/8 way wedge	\$57,839.00
HWP-200GS	Grapple Saw	\$16,134.00
HWP-275GS	Grapple Saw NEW	\$19,306.00
HWP-WHS10	100/120 Main Cab Harness Kit	\$1,456.00
HWP-WHS8	140B//150 Main Cab Harness Kit	\$1,560.00
HWP-WHGHK	Grapple Saw Cab Harness Kit	\$550.00
No # available	120 Joystick Harness Kit	\$2,072.00
No # available	140B or 150 Joystick Harness Kit	\$1,781.00
No # available	Bob Cat Harness	\$313.00
HWP-2111	120/140B 6-way Wedge	\$1,080.00
HWP-2112	150 6-way Wedge	\$1,192.00
No # available	160 4-way Wedge	\$1,690.00
No # available	160 6-way Wedge	\$2,005.00
No # available	160 8-way Wedge	\$2,321.00
No # available	Inverted Splitter	\$7,062.00
No # available	Grill NEW	\$307.00
No # available	Firepit NEW	\$254.00

PRICED IN CANADIAN DOLLARS

PRICES ARE FOB HARRISTON, ONTARIO – DESIGN & PRICE ARE SUBJECT TO CHANGE WITHOUT NOTICE



5808 Hwy #9, Harriston, Ontario, N0G 1Z0
 Phone: 519-338-2923, Fax: 519-338-2756
 Email: sales@harcoag.ca
www.harcoag.ca

File Section: 5, Page 15
 Effective Date: April 1, 2025



Amended September 2025

LEFT HAND PROCESSORS

Model	Description	Price [CDN]
HWP-140B	LH Processor w/4 way wedge	\$28,730.00
HWP-140B	LH Processor w/6 way wedge	\$29,077.00
HWP-140B	LH Processor w/4 way & 6 way wedge	\$29,812.00
HWP-150	LH Processor w/4 way wedge	\$36,938.00
HWP-150	LH Processor w/6 way wedge	\$37,296.00
HWP-150	LH Processor w/4 way or 6 way wedge	\$38,129.00

EXTENDED PROCESSORS

Model	Description	Price [CDN]
HWP-150	Extended Processor w/4 way wedge	\$37,967.00
HWP-150	Extended Processor w/6 way wedge	\$38,322.00
HWP-150	Extended Processor w/4 way or 6 way wedge	\$39,154.00

SHUTTLE SHAVERS

Model	Description	Price [CDN]
No # available	Shuttle Shaver 1524 NEW	\$11,012.00
No # available	Shuttle Shaver 2447 NEW	\$25,019.00

PTO DRIVEN HYDRAULIC POWER UNIT

PLEASE NOTE: This unit comes dry, oil is extra (requires 25 U.S. gallons) not included in below prices

Model	Description	Price [CDN]
HWP-HPU	With Cooler Assembly	\$6,215.00

PRICED IN CANADIAN DOLLARS

PRICES ARE FOB HARRISTON, ONTARIO – DESIGN & PRICE ARE SUBJECT TO CHANGE WITHOUT NOTIC



Wood Products, Inc.
Amended September 2025

TRAILER MODELS

Model	Description	Price [CDN]
100-3PT	Trailer Processor w/2 way	\$13,563.00
100-3PT	Trailer Processor w/4 way	\$13,957.00
PUMP	Optional Hydraulic Pump Kit for 3PT	\$4,255.00
ADJ.WEDGE	Hydraulic 4-WAY wedge for 100-3PT	\$837.00
100TR-H	Trailer Processor w/2 way (Honda Engine)	\$24,625.00
100TR-H	Trailer Processor w/4 way (Honda Engine)	\$25,019.00
ADJ.WEDGE	Adjustable hydraulic 4 way wedge for 100TR-H	\$837.00

BALE BUDDY 2000

Model	Description	Price [CDN]
Bale Buddy 2000	Bale Wrapper – See Section 3, Page 20 for details	\$8,373.00



www.halversonwoodproducts.com

PRICED IN CANADIAN DOLLARS

PRICES ARE FOB HARRISTON, ONTARIO – DESIGN & PRICE ARE SUBJECT TO CHANGE WITHOUT NOTICE



Specification Pages

Harco Ag Equipment
 5808 HWY 9, Harriston, Ont.
 NOG120
 519-338-2923
 sales@harcoag.ca
 File Section: 5, Halverson
Effective: January 1, 2026

	HWP-100	HWP-120	HWP-125GS	HWP-140B	HWP-150	HWP-150 EXTENDED	HWP-160
LENGTH	Travel= 80" (203 cm) Working= 100 (254 cm)	Travel= 99" (203251 cm) Working= 121" (307cm)	33" (84 cm)	Travel= 102" (259 cm) Working= 126" (320 cm)	Travel= 107" (272 cm) Working= 129" (328 cm)	Travel= 121" (307 cm) Working= 143" (363 cm)	144" (366 cm)
WIDTH	41" (104 cm)	55" (140 cm)	46" (142 cm)	55" (140 cm)	58" (147 cm)	58" (147 cm)	68" (172 cm)
HEIGHT	41" (104 cm)	51" (130 cm)	41" (104 cm)	51" (130 cm)	57" (145 cm)	57" (145 cm)	70" (178 cm)
WEIGHT	706 lbs (320 kg)	1280 lbs. (581 kg)	770 lbs. (349 kg)	1450 lbs. (658 kg)	1638 lbs. (743 kg)	1905 lbs. (864 kg)	2347 lbs. (1065 kg)
MATERIAL	3/16" Steel	1/4" Steel	3/8" & 5/8" Steel	3/8" Steel	3/8" Steel	3/8" Steel	3/8" Steel
-MINIMUM PRESSURE	2800 (193 bar)	2850 (196 bar)	2850 (196 bar)	2850 (196 bar)	2850 (196 bar)	2850 (196 bar)	2850 (196 bar)
-FLOW	10-15 gpm (39 - 57 l/min)	14-20 gpm (53 - 76 l/min)	15-20 gpm (57 - 76 l/min)	15-20 gpm (57 - 76 l/min)	15-20 gpm (57 - 76 l/min)	15-20 gpm (57 - 76 l/min)	15-20 gpm (57 - 76 l/min)
-CONNECTIONS	1-Pressure, 1-Return	1-Pressure, 1-Return 1-Case Drain	1-Pressure, 1-Return 1-Case Drain	1-Pressure, 1-Return 1-Case Drain	1-Pressure, 1-Return 1-Case Drain	1-Pressure, 1-Return 1-Case Drain	1-Pressure, 1-Return 1-Case Drain
MAX LOG DIAMETER	14" (37 cm)	15" (38 cm)	27" (69 cm)	18" (46 cm)	22" (56 cm)	22" (56 cm)	24" (60 cm)
MAX LOG LENGTH	10' (3.05 m)	12' (3.66 m)	NA	12' (3.66 m)	12' (3.66 m)	12' (3.66 m)	12' (3.66 m)
MIN LOG LENGTH	4' (1.22 m)	6' (1.82 m)	NA	6' (1.82 m)	6' (1.82 m)	6' (1.82 m)	6" (1.21 m)
FIREWOOD CUT LENGTH	Up to 16" (33cm - 38 cm)	Up to 22" (56 cm)	NA	Up to 22" (56 cm)	Up to 22" (56 cm)	Up to 33" (84 cm)	16" to 22" in 2" Increments
SAW BAR	18" (64 cm) Versacut	25" (64cm) Harvester	31" (80cm) Harvester	25" (64cm) Harvester	31" (80cm) Harvester	31" (80cm) Harvester	32" (82 cm) Speedmax XL
SAW CHAIN	68 DL 3/8 pitch 0.58	78 DL .404 pitch/18HX	93 DL .404 pitch/18HX	78 DL .404 pitch/18HX	93 DL .404 pitch/18HX	93 DL .404 pitch/18HX	97 DL .404 pitch/18 HX
SAW MOTOR	Gear	Bent Axis Piston	Bent Axis Piston(Industrial)	Bent Axis Piston(Industrial)	Bent Axis Piston(Industrial)	Bent Axis Piston(Industrial)	Bent Axis Piston (Industrial)
SAW OILER	Automatic 2 Qt (1.89 l)	Automatic 2 Qt (1.89 l)	Automatic 2 Qt (1.89 l)	Automatic 2 Qt (1.89 l)	Automatic 2 Qt (1.89 l)	Automatic 2 Qt (1.89 l)	Automatic 2 Qt (1.89 l)
MAX SAW CUT	14" (37 cm)	15" (38 cm)	27" (69cm)	18" (46 cm)	22" (56 cm)	22" (56 cm)	22" (56 cm)
SPLITTER CYLINDER	Custom 3" x 18" Stroke	Standard 3.5" x 24" Stroke	NA	Custom 3.5" x 24" Stroke	Custom 4" x 24" Stroke	Custom 4" x 36" Stroke	4.5" Bore x 22" Stroke
SPLITTER FORCE	21,195 @ 3000 psi	28,850 @ 3000 psi	NA	28,850 @ 3000 psi	36,138 @ 3000 psi	36,138 @ 3000 psi	43,331 lbs. @ 2850 psi
SPLITTING WEDGE	2-way or 4-way	4-way or 6-way Manually Adjustable	NA	4-way or 6-way Manually Adjustable	4-way or 6-way Hydraulically Adjustable	4-way or 6-way Hydraulically Adjustable	4-way, 6-way or 8-way Hydraulically Adjustable
IN-FEED	Sliding Trough Carries Log to Wedge	Sliding Trough Carries Log to Wedge	Grapple	Sliding Trough Carries Log to Wedge	Sliding Trough Carries Log to Wedge	Sliding Trough Carries Log to Wedge	Feed Chain/Roller arm
MOUNTING	Universal Quick Attach SAE Spec J2513	Universal Quick Attach SAE Spec J2513	Universal Quick Attach SAE Spec J2513	Universal Quick Attach SAE Spec J2513	Universal Quick Attach SAE Spec J2513	Universal Quick Attach SAE Spec J2513	Universal Quick Attach SAE Spec J2513
MEASURING	NA	NA	NA	Manual Moveable Device	Manual Moveable Device	Manual Moveable Device	Manual Moveable Device

Full Cord/Hour	¾ to 1 full cord/hour	1 to 1 ¼ full cord/hour		1 ½ full cord/hour	1 ½ full cord/hour		1 ¾ full cord/hour

ABOVE AMOUNTS DEPENDS ON WOOD QUALITY & VARIETY

Full Cord = eight feet long by four feet high by four feet deep

Face Cord = four feet high by eight feet long by however deep the length of the firewood is or 1/3 of a full cord

	HWP-100TR-D	HWP-100TR-H	HWP-100-3P	Hydraulic Pump Kit For 3 Point	
LENGTH	Travel= 126" (320 cm) Working= 96" (244 cm)	Travel= 126" (320cm) Working= 96" (244 cm)	81" (205 cm) W/ Hyd. Wedge- 86" (218 cm)	Fluid Capacity	15 US Gallon
WIDTH	68" (172 cm)	68" (172 cm)	64" (162.5 cm)	Pump Flow Rate	21.2 GPM
HEIGHT	64" (162.5 cm)	64" (162.5 cm)	62" (157.5 cm)	Pump Max	2,500 PSI
WEIGHT	1260 lbs (572 kg)	1405 lbs (637 kg)	1027 lbs (466 kg)	Pump PTO Speed	540 RPM
CONNECTIONS	NA	NA	1-Pressure, 1-Return	Hydraulic Cooler	50 GPM
MATERIAL	3/16" Steel	3/16" Steel	3/16" Steel	Pressure Relief Valve	2,400 PSI
MAX LOG DIAMETER	14" (37 cm)	14" (37 cm)	14" (37 cm)	Hydraulic Fan & Wiring	12 Volt
MAX LOG LENGTH	8' (2.44 m)	8' (2.44 m)	8' (2.44 m)	Thermostat	Max 185°F (85°C)
MIN LOG LENGTH	4' (1.22 m)	4' (1.22 m)	4' (1.22 m)	Filter Assembly & Filter	25 Micron
FIREWOOD CUT LENGTH	Up to 16" (33cm - 38 cm)	Up to 16" (33cm - 38 cm)	Up to 16" (33cm - 38 cm)	Adjustable Legs	
SAW BAR	18" (64 cm) Versacut	18" (64 cm) Versacut	18" (64 cm) Versacut		
SAW CHAIN	68 DL 3/8 pitch 0.58	68 DL 3/8 pitch 0.58	68 DL 3/8 pitch 0.58		
SAW MOTOR	Gear	Gear	Gear		
SAW OILER	Automatic 2 Qt (1.89 l)	Automatic 2 Qt (1.89 l)	Automatic 2 Qt (1.89 l)		
MAX SAW CUT	14" (37 cm)	14" (37 cm)	14" (37 cm)		
SPLITTER CYLINDER	Custom 3.5" x 18" Stroke	Custom 3.5" x 18" Stroke	Custom 3" x 18" Stroke		
SPLITTER FORCE	21,195 @ 2600 psi	21,195 @ 2600 psi	21,195 @ 2400 psi		
SPLITTING WEDGE	2-way or 4-way	2-way or 4-way	2-way or 4-way		
IN-FEED	Sliding Trough Carries Log to Wedge	Sliding Trough Carries Log to Wedge	Sliding Trough Carries Log to Wedge		
TIRE SIZE	4.8-12	4.8-12	X		
MOUNTING	2" Ball	2" Ball	3-point		
MOTOR	DuroMax 420CC	GX630 Honda 20.8 hp 1" Keyed Shaft	x		
FUEL CAPACITY (GAS)	1.75 Gal	1.5 Gal	x		
OIL CAPACITY	37.2 FL OZ	15 Gal	x		
RPM	3600	3600	x		
PUMP	High Low	Honor Gear Pump 5/8 Keyed Shaft	HPU option		
GPM	16	16	10-15 GPM		
HYDRAULIC FILTER		Spin On			

	200 GRAPPLE SAW	275 GRAPPLE SAW
OPENING	37.5"	37.5"
LENGTH	48"	48"
WIDTH	33"	33"
HEIGHT	42"	41"
WEIGHT	885 LBS.	1100 LBS.
MATERIAL	3/8" & 5/8" Steel	3/8"-5/8" Steel
MINIMUM PRESSURE	2850 psi	2850-psi
FLOW	15-20 GPM	High Flow 26 to 40 GPM
CONNECTIONS	1- Pressure, 1-Return, 1- Case drain	1- Pressure, 1- Return, 1- Case Drain
MAX LOG DIAMETER	27"	36"
SAW BAR	31" (80cm) Harvester	45" Harvester
SAW CHAIN	93 DL .404 pitch/ 18HX Series	3/4" pitch
SAW MOTOR	Bent Axis piston (Industrial)	Bent Axis Piston
OILER	Automatic 2 Qt tank	Automatic 2 Qt Tank
MAX SAW CUT	27"	36"
IN FEED	Grapple	Grapple
MOUNTING	Universal Quick Attach SAE Spec J2513	Universal Quick Attach SAE Spec J2513

Shuttle Shaver's	Shuttle Shaver 2447	Shuttle Shaver 1524
Pump	Low Flow 14-20 GPM	14-20 GPM
Box Size	24"x47"	15"x23"
Ram Stroke	48" 2 1/2" barrel	24"
Weight	1677 lbs.	613 lbs.
Yards per hour	4.67 cubic yards per hour	2.67 cubic yards per hour
Wheels	Steel wheels	Steel Wheels
Shaft	4 bolt bearings on shaft	4 bolt bearings on shaft
Mounting	Universal Quick Attach SAE Spec J2513	Universal Quick Attach SAE Spec J2513
Knife	25" knife- 6 row cutters- 168 cutters	15"
Material	3/8" steel	54"
Lenth	106"	38"
Width	48"	1/4" Steek
Height	51"	31"

Inverted Splitter
Length: 90"
Width: 46"
Height: 23.5"
Weight: 843 LBS
Material: A 36 and Gr 50 Steel
Hydraulics: 4"x30" Hyd. Cylinder
Pressure: Up to 3,300 PSI
Flow: 5-20 GPM
Connections: Quick Coupler Flat Face
Cut Length: 30"
Splitter Cylinder: 4"x30"
Splitter Force: 36,138 @ 3,000PSI
Splitting Wedge: 4 Way
Mounting: Quicktach

HWP Bale Wrapper
Length: 72" (183 CM)
Width: 40" (102 CM) Base/ 104" (264cm) Top
Height: 90" (229cm)
Weight: 853 Lbs.
Bale Size: 4x5 or 5x6
Connections: 14 Pin / Main Cab Kit
Wrap: Standard Film Wrap
Hydraulics: Auxiliary Hydraulics

Shipping Specifications

ITEM	WEIGHT	DIMENSIONS (LxWxH)	NMFC/ Class
HWP 100 Processor w/ 2 Way Wedge	770 lbs	82x36x48	133300-09/ 100
HWP 100 Processor w/ 4 Way Wedge	779 lbs	82x36x48	133300-09/ 100
HWP 100 Processor w/ both Wedges	800 lbs	82x36x48	133300-09/ 100
HWP 120 Processor- FIXED	1380 lbs	96x36x48	133300-09/ 100
HWP 120 Processor w/ 4 Way Wedge	1380 lbs	96x36x48	133300-09/ 100
HWP 120 Processor w/ 6 Way Wedge	1393 lbs	96x36x48	133300-09/ 100
HWP 120 Processor w/ both Wedges	1447 lbs	96x36x48	133300-09/ 100
HWP 140B Processor w/ 4 Way Wedge	1550 lbs	102x36x56	133300-08/ 175
HWP 140B Processor w/ 6 Way Wedge	1563 lbs	102x36x56	133300-08/ 175
HWP 140B Processor w/ both Wedges	1617 lbs	102x36x56	133300-08/ 175
HWP 150 Processor w/ 4 Way Wedge	1738 lbs	107x44x64	133300-08/175
HWP 150 Processor w/ 6 Way Wedge	1749 lbs	107x44x64	133300-08/175
HWP 150 Processor w/ both Wedges	1816 lbs	107x44x64	133300-08/175
HWP 150 Extended w/ 4 Way Wedge	2005 lbs	121x44x64	133300-08/175
HWP 150 Extended w/ 6 Way Wedge	2016 lbs	121x44x64	133300-08/175
HWP 150 Extended w/ Both Wedges	2083 lbs	121x44x64	133300-08/175
125GS HD Grapple Saw	845 lbs	48x48x42	114225-01/ 100
Grapple	735 lbs	48x48x42	114225-01/ 100

5808 Hwy #9, Harriston, Ontario, N0G 1Z0
Phone: 519-338-2923, Fax: 519-338-2756
Email: sales@harcoag.ca
www.harcoag.ca



SMV SIGNS

Harco SMV signs are high quality, locally made signs from dedicated craftsmen. Our regular signs are priced competitively with those of mass merchants and meet current requirements. High Visibility signs have more resolution for better visibility. Keep your customers, families and employees safe by always using signs that are current and in good condition.

Model	Description	Price (Each)
*AP101	Flat Plastic Back SMV Sign – 12 pack	\$8.65
AP102	Decal Only For Sign – 12 pack	\$6.80
*AP103	Metal Back SMV Sign (Galvanized) – 12 pack	\$10.65
AP105	Plastic Back SMV Sign (Heavy Plastic) – 10 pack	\$9.55
*AP101NS	Flat Plastic Back SMV Sign High Vis. – 12 pack	\$12.40
AP102NS	Decal Only for SMV Sign High Vis. – 12 pack	\$10.65
AP103NS	Metal Back SMV Sign High Vis. – 12 pack	\$15.35
AP105NS	Plastic Back SMV Sign High Vis. – 10 pack	\$13.60
*SMV50	Spade for SMV Sign (come in any quantity)	\$3.15
*SMV25	Socket for SMV Sign Holder (come in any quantity)	\$2.70

** Inventory stocked at Harriston*

Expedite your orders by emailing your P/O with complete shipping instructions to parts@harcoag.ca



PolyTech Plastic Wear Products

Keeping your equipment operating at peak efficiency is vital in today's agricultural market. Poly Tech manufactures a full line of products including corn head liners, grain tank liners, grain and auger bed trough liners and much more to ensure you always get top performance.

Every one of our products is rigorously tested in real-world conditions and designed to fit perfectly on a wide variety of equipment brands.

We offer a complete line of polymer wear products for plows, combine headers and many other applications. Featured within these pages are some of our most common selling items. If you would like to see a full catalogue please contact your Territory Manager.

Please note, catalogue prices are in U.S. Dollars, so it is best to contact our Parts Department for pricing either through our website or email to parts@harcoag.ca.

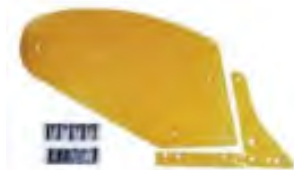

QUICK REFERENCE INDEX



**Auger
Tube Liner**



**Deere 200
900/900F**



**200/900
900F Green**



**John Deere
600 Series**



**CIH 1020
Skids**



**Case Auger
Bed Liner**



**JD Auger
Bed Liner**

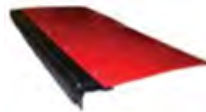

**Case 1020
Feed Plate**



**Grain
Grabber 2**



**Tru Tube
Tool**



**Poly Clean
Out Door**



**Clean Grain
Elevator Auger
Cover**



**Stubble
Stoppers**



**Stalk Stomper
Replacement Shoes**



**Case Corn
Head Liners**



**Strip-Till
Accessories**



**Poly Moldboard
Cover**



Drill Drain



**Sprayer
Nozzles**



**RFM
Coil Wheels**

COMBINE

CORN HEAD

TILLAGE

SPRING

PEANUT

COTTON

HAY

HARDWARE

MATERIAL

TOOLS/SAFETY



CIH Stabilizer Cover



New Holland Skids



Mac Don Skids



AGCO Skids



Feeder House Kit



Poly Auger Fingers



Grain Tank Liners



AGCO Grain Tank Liner

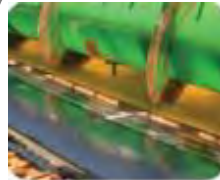

Auger Trough Liners



Poly Auger Wear Shoes



JD Corn Head Liners



AGCO Corn Head Liner



Hood Patch Kits



Corn Stalk Guides



Ripper Shins & Covers



Peanut Combine Parts



Cotton Picker Parts



Poly Pick-Up Bands



Hardware

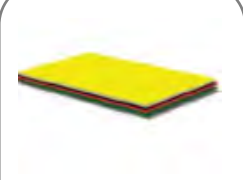

Poly Last™ Sheets