

Power Tillers

EL Series



www.kuhn.com



Invest in Quality[®]

POWER TILLERS EL SERIES

INTENSIVE TILLAGE FOR BETTER RESULTS IN HEAVY SOILS

For over 50 years KUHN has been perfecting the rotary power tiller while always focusing on giving producers, from homeowners to large commercial operators, the best ROI (Return on Investment) possible.

BUILT TO PERFORM

This goal is accomplished through the use of high-quality materials, innovative and durable designs, and an extensive application of earned agronomic knowledge.

AN EXCELLENT MIXTURE TO HELP YOU REACH SUCCESS

Incorporating residue, enhancing soil structure, and improving subsequent root development; if one or more of these are goals you want to accomplish, a KUHN power tiller is your solution.

POWER TILLERS EL Series in brief:

Series	Working Width	Maximum Working Depth	Max PTO Power (hp)
EL 23	4'1" - 4'9"	4"	25
EL 43	3'6" - 6'2"	6"	40
EL 53	3'2" - 6'2"	6"	50
EL 62	4'2" - 6'11"	7"	65
EL 82	4'3" - 6'9"	9"	85
EL 92	5'11" - 7'7"	9"	100
EL 122	8'2" - 9'10"	9"	125
EL 162	8'2" - 9'10"	10"	165
EL 282	9'10" - 15'	11"	270
EL 402 R	20'3"	10"	400



MULTI-PURPOSE TOOLS for MULTI-PURPOSE USES

KUHN power tillers are highly versatile and well adapted for use in crop farming, land reclamation, and vegetable production. They work the soil intensively and perform in virtually all conditions, especially in heavy soil or rocky conditions. One pass is usually sufficient to create a well prepared seedbed. In combination with an integrated seed drill, seeding can be carried out at the same time.



IMPROVE YOUR SOIL

Blades work the soil and eject it against the hood. This way it is effectively loosened, crumbled, and mixed together. KUHN power tillers are designed for intensive soil loosening and breaking up of dirt clods. The work intensity depends on the rotor speed, tool type, and forward travel speed. A general rule of thumb is the slower you work with the tiller, the quicker the rotor shaft turns, giving you a more fine and crumbled soil mixture. It's important not to exaggerate this, as the soil's natural crumble structure might be damaged.



1. FAST DECOMPOSITION OF RESIDUES

Rotor tillers mix surface residues with the soil and loosen it to let air in. With this method, harvest residues, cover crops, or grass root systems are rapidly decomposed.

2. BREAKING UP PASTURES

The tiller blades also cut and mix heavily rooted soil effectively, making it a perfect tool for breaking up pastures or former conservation land.

HIGH-QUALITY TILLING WITH MINIMAL MAINTENANCE



CUT MATERIAL FOR BETTER SOIL STRUCTURE

Cut plant debris including tree/vine prunings, incorporating mulch and cover plants into the soil, or plowing up a permanent vegetation cover. The Cultirator (C-blades) of KUH N power tillers provide exceptional cutting of plant material before working it into the soil for a better overall structure.



NO CHANCE FOR WEEDS

During the growing season, weeds compete for nutrients and water with vines and fruit trees. Spring or summer tillage with power tillers constitutes an environmentally friendly alternative to chemical control. Soil organisms are replenished with the nutrients they need, while the weeds are permanently weakened.

Designed with the same precision and attention to detail as KUH N's large, professional-grade tillers, the EL 23 addresses the particular needs for small tiller operators including:

- High-quality tilling producing a smooth and clean finish, ready for planting or seeding
- Minimal maintenance with no oil changes or chain tension adjustment required
- Easy access to hitch points when attaching or detaching from the tractor



MINIMAL MAINTENANCE

The design of the drivetrain eliminates the need for periodic maintenance. Use of semi-fluid grease in the central gearbox and an automatic slack adjuster provides:

- No need for oil changes
- No chain tension adjustment



EASY ACCESS

The PTO cross, points and slip clutch are easily accessible. Access to grease the PTO cross is accomplished by loosening a few wing nuts and pulling the guard forward.



HIGH CLEARANCE ROTOR

The rotor and hood design maximizes the efficiency of smaller tractors. Soil and clods flow freely to effectively work the ground without producing unnecessary drag that robs horsepower from the tractor. The solid steel rotor shaft is fitted with high-quality steel blades specifically designed to work in varying conditions, including vegetation and organic materials.



DURABLE AND RELIABLE

A versatile tool is what growers like you expect when buying a power tiller. KUHN power tillers meet these needs while mastering difficult soils and dealing with the presence of rocks without any long-term impact on the machine.

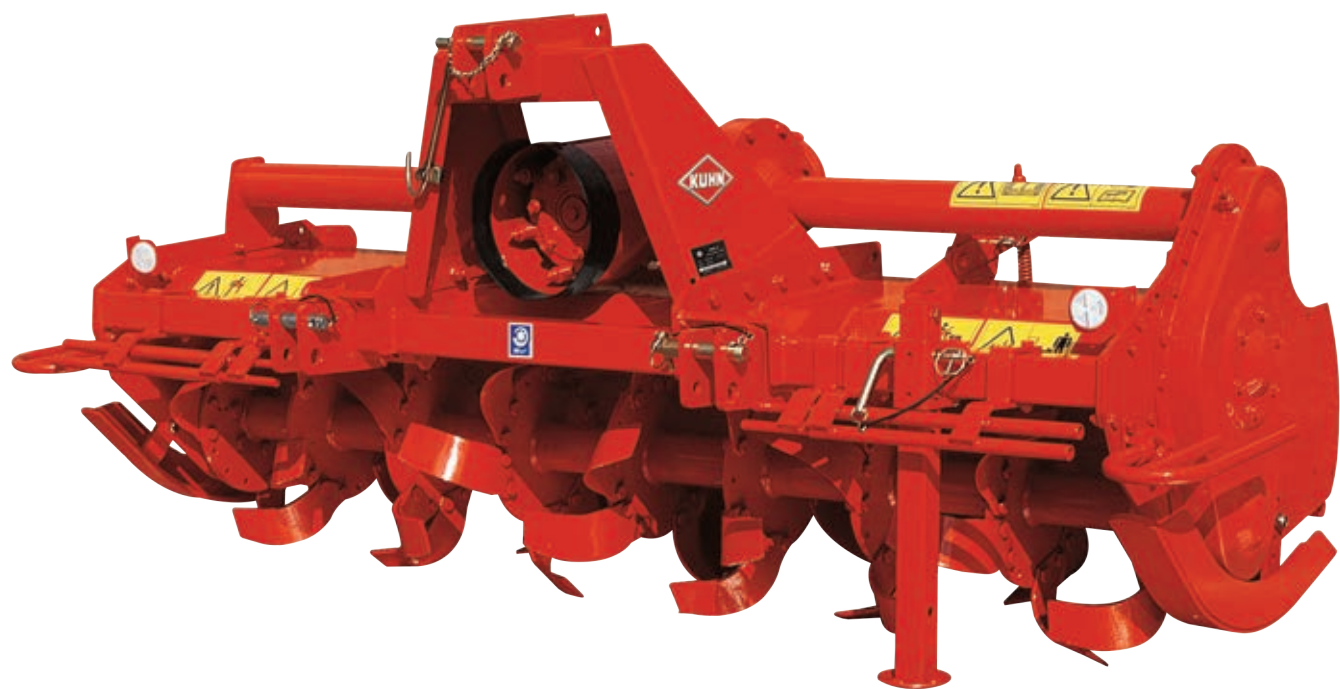

BUILT TO LAST HEAVY-DUTY FRAME

The EL 62, 82, and 92 are grouped together by a large frame providing high rigidity and exceptional endurance. The front portion is integrated with the casing, increasing the machine's strength and giving you the potential to attach other equipment if needed.

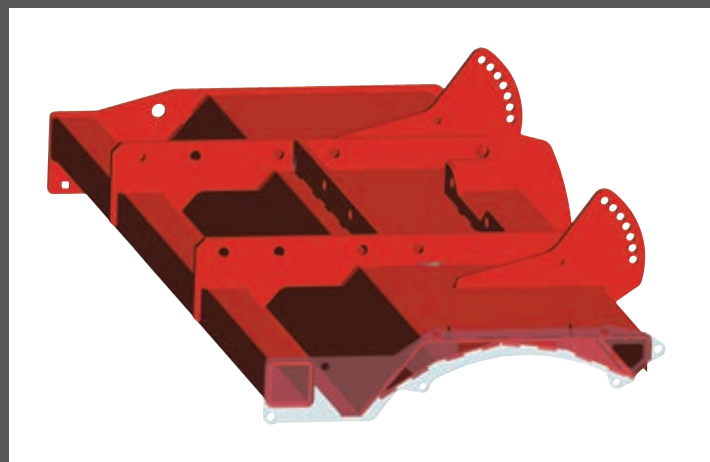

ROTOR DRIVE

Optimum operating performance

Reliable and safe with very little maintenance needed. What else would you expect from a KUHN tiller?



EL 43/53: LONG SERVICE LIFE

The rotor is driven by tempered steel sprockets, located in a side case with thick walls on the EL 53. The oversized chain with automatic tension adjustment is much more resistant to fatigue than competitive models. The drive chain is immersed in an oil bath for consistent lubrication.

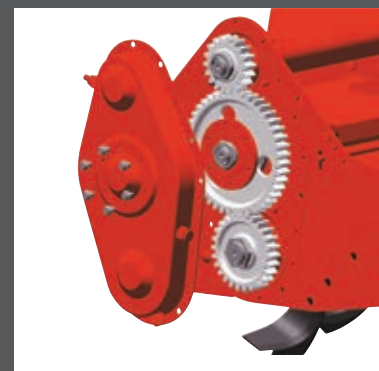

EL 62/82/92: HIGH CAPACITY DRIVE

On the larger EL models, the rotor is driven by case hardened, forged steel gears, which are mounted on conical or double-row roller bearings for maximum capacity. They run in an oil bath. The heavy-duty sealing of the lower gearcase is fitted with a metallic face seal, which provides the highest possible resistance to leaking and contamination in abrasive soil conditions.

CENTRAL GEARBOX

Rugged, yet refined

EL 43/53: REDUCED ANGLES FOR INCREASED SERVICE LIFE

The central cast iron gearbox of the chain-drive models is mounted directly on the tiller frame with hardened forged steel gears that run in an oil bath. It can be offset with the 3-point frame to avoid an awkward angle on the transmission. This allows it to work easily under trees and on field edges. The drive is protected as standard by a friction slip clutch.



EL 62/82/92: ALL THE BASICS WITH EVEN MORE VERSATILITY

On the gear-drive models, the central gearbox is cast iron and set back for reduced PTO angles. A friction slip clutch is standard for protection of the drivetrain. The EL 92 Duplex gearbox offers two speeds by inverting the gears. Two additional speeds are available as optional equipment, offering the adaptation capability to various working conditions.



PROVIDING HIGH WORK QUALITY AND VERSATILITY

KUHN power tillers are versatile tools, meeting the various needs and requirements of vineyards, market gardeners, horticulturists, etc. With their sophisticated features, they provide exceptional work quality and efficiency in a wide range of conditions.



PROGRESSIVE LATERAL OFFSET

Offset hitch capability allows a tiller that is narrower than the tractor to erase the tractor wheel track on its right side. Offsetting the hitch is easily accomplished by sliding the three yokes of the tiller frame. Thanks to this continuous manual offset, the machine can be adapted according to the situation to ensure perfect stability.

C-BLADES FOR OPTIMUM TILLAGE

The special curved design of KUHN tiller blades have been tested and optimized for:

- Chopping and mixing of plant residues
- Aggressive cutting into hard soil while requiring less horsepower
- Increased crumbling of soil clods

The EL 43 is fitted with four blades per flange as standard (six as an option), while all other models possess six for even more efficient crumbling. For shallow work, L-blades can be fitted on the EL 53 to EL 92 models.

SERIES	MODEL	OFFSET
EL 43	105 / 130 / 150	8" / 12" / 16"
	190	fixed
EL 53	100 / 130 / 155	6" / 12" / 12"
	190	fixed
EL 62	130 / 155 / 165 / 180	8"
	210	fixed
EL 82	130 / 155 / 180	8"
	205	fixed
EL 92	180	4"
	205 / 230	fixed

REAR HOOD

A match for all conditions

The rear hood of EL tillers is ideally shaped for uniform soil flow and adaptable to various conditions: shallow or deep tillage, dry or wet soil, and different quantities of plant residues. You can adjust the hood to fit your needs.

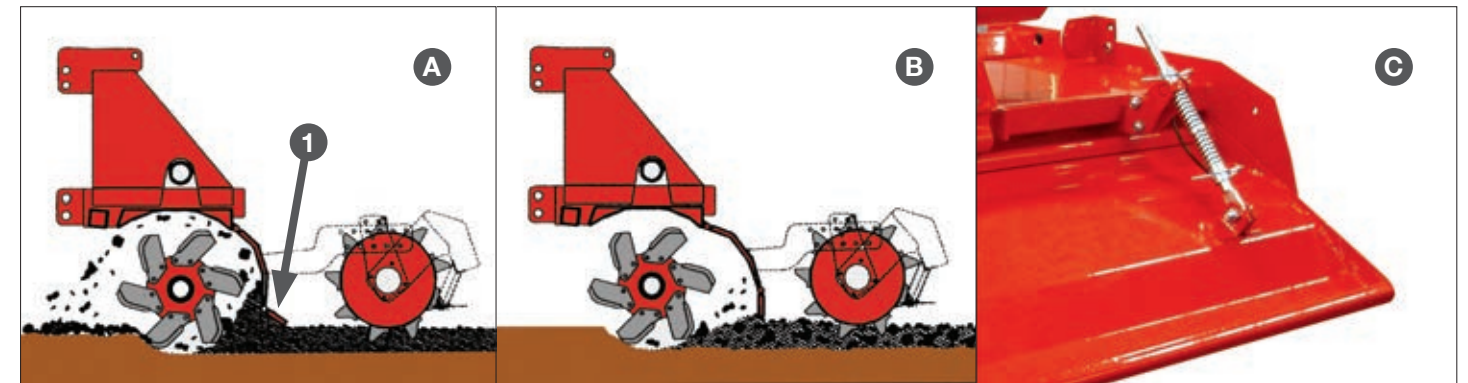

HOW MUCH CRUMBLING AND LEVELING? YOUR CHOICE!

If the rear hood is positioned close to the rotor **A**, it accumulates soil until the latter is recycled to the front, which results in a high crumbling degree. In wet conditions or in plant residues, the machine will cope better with a more open rear hood **B**. Even more efficiency is provided with the leveling extension available on EL 62, 82 and 92 **1**. The rear hood is spring-loaded **C** for optimal seedbed preparation where additional firming and leveling is needed.

SIMPLE ADJUSTMENTS

Adjusting the rear hood is quick and easy, either by checking the chains on the EL 43 or repositioning the pins on the larger models.



THE KUHN PLUS: A COMPACT DESIGN

All KUHN power tillers for vineyards and orchards are a very compact design for efficient operations in narrow rows. The EL 43 is additionally known for its exceptionally low profile for passing safely under overhanging branches. It is the small overall width-to-working width ratio of the EL 62, 82 and 92 that particularly shines in narrow-row applications. Moreover, the rounded hood edges and skids protect plants from damage.



COMPACT TOOL FOR GARDENING AND LANDSCAPING

The EL 43 power tiller is an adaptable tool and suitable for various tasks. It has been designed for seedbed preparation, gardening, greenhouse operations and landscape maintenance. It is particularly suited for compact and small tractors from 15 to 40 horsepower.



FLEXIBILITY TO MASTER ALL KINDS OF SOIL PREPARATION

EL 53 power tillers are designed for operation in demanding environments on tractors with greater horsepower. Greenhouse operators, landscapers, and large food plot producers who demand the most from a tiller will find peace of mind with the EL 53. With upgraded features compared to the EL 43, it is the ideal tool for you to use as you begin to prepare soil for planting.



PROTECT YOUR LANDSCAPE

The compact design and low profile of the EL 43 power tiller allows the tiller to work safely under overhanging branches and close to greenhouses.

WORKING DEPTH CONTROL: CHOOSE BASED ON YOUR NEEDS

All EL 43 power tillers are fitted as standard with easily adjustable depth control skids **1**. Where necessary, optional depth control wheels are available **2**. The wheels are standard on EL 53 tillers. Optional skids **3** or heavy-duty wheels **4** with a larger diameter and a stronger wheel column are available as an option for the EL 53. No restrictions from easy operations to more demanding applications!

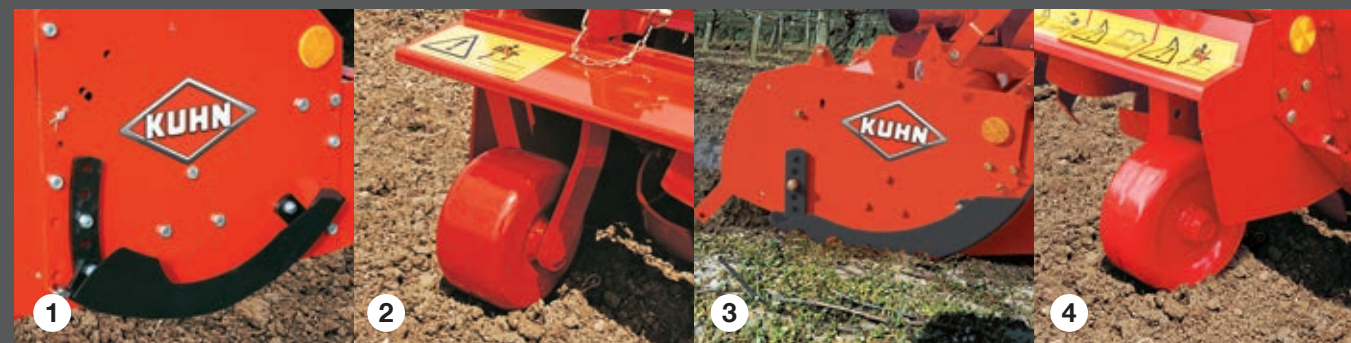

QUICK HITCH COMPATIBLE

With the optional adapter, the hitches on the EL 43 and 53 are compatible with a Cat. 1 quick hitch for faster attachment and removal.



POWER TILLERS EL 62 / 82 / 92

THE SPECIALTY CROP WORKHORSE

The EL 62, 82 and 92 KUHN power tillers are the result of a long history in soil preparation and decades of research and development. Particular care has been given to the following fundamental criteria:

- A design for demanding vineyard, market garden, horticulture and tree nursery professionals
- A high level of versatility and adaptability
- Simple adjustments enabling fast adaptation to all situations
- High reliability and long life for continued peace of mind

MULTIPLE HIGHLIGHTS



GREAT DURABILITY

The rotor drive is constructed with case-hardened, forged steel gears. The main frame is built from a large box-section casing.



COMPACT DESIGN COMBINED WITH VERSATILITY

Small overall working width ratio, with continuous lateral offset attachment on EL 62, ideal for vineyards, market gardens, horticulture, and tree nurseries.



HIGH WORK QUALITY UNDER ALL CONDITIONS

The optimized design of the rear hood is adjustable, especially when changing work intensity with C-blades for optimum tillage and plant residue handling.

EFFICIENCY – VERSATILITY – ADAPTABILITY

OPTIONAL EQUIPMENT: MULTIPLE POSSIBILITIES



SIDE SEPARATING DISCS
Avoid ridge formation between two passes and facilitate work in long plant residues. Easily adjustable by a pin.



TRACK ERADICATORS
Loosen the soil behind tractor wheels. Made up of four flexible tines adjustable in height and distance.



SIGNALING EQUIPMENT
This replaces the tractor's signaling when covered by the power tiller.



L-BLADES
For shallow cultivation and reducing weeds, the rotor can be fitted with L-blades.



COUNTER FLANGES
EL 92 power tillers can be fitted with counter flanges for reinforced blade hold in rocky conditions.

DEPTH CONTROL: MULTIPLE CHOICES

On all models, working depth is controlled by using skids **1** or wheels **2**. On the EL 82-180, 205 and all EL 92 power tillers, rollers are available as an option:

- Crumbler rollers **3** with a large diameter of 15" with removable bars
- Packer rollers **4** with a diameter of 19" are recommended for very wet conditions or clay soils





POWER TILLERS EL 122 / 162

DESIGNED FOR LONG LIFE AND SIMPLE OPERATION

EL 122 and EL 162 power tillers are intended for tractors rated up to 125 horsepower and 165 horsepower, respectively. As with all KUHN implements intended for soil preparation, these power tillers feature a particularly sturdy design.

The one-piece frame, two-speed gearbox and the gear side drive meet the most stringent reliability requirements. They are designed for convenient operation, with extremely quick and easy to perform adjustments.

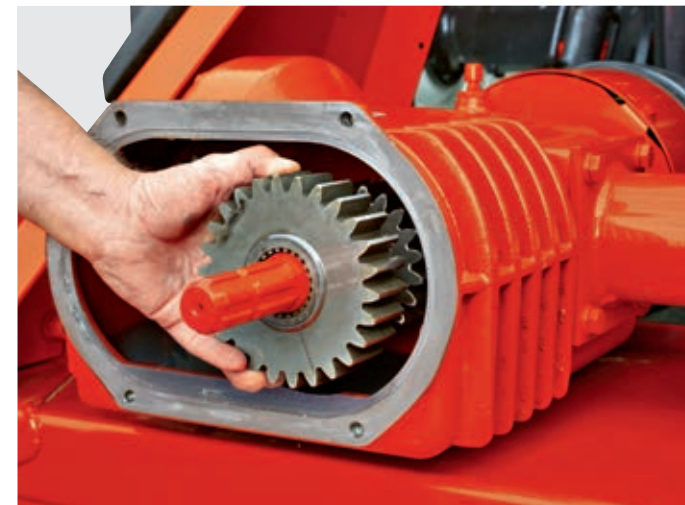

DUPLEX GEARBOX: FLEXIBILITY FOR DIFFERENT SOIL CONDITIONS

Designed for heavy-duty applications, the gearbox is capable of handling powerful tractors. Thanks to the invertible gear sets, the rotor speed can be quickly adapted to obtain the required result: an adequate crumbling whatever the soil type is, light or hard. To offer a larger range of speeds, standard gear sets, as well as optional gears are available. A rear PTO stubshaft is available as standard, which enables power to be transmitted to other implements fitted to the tiller.

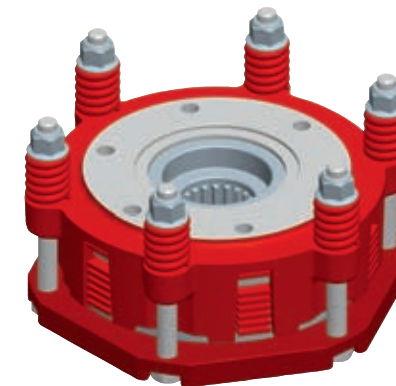

EFFECTIVE DRIVELINE PROTECTION

All models feature a torque limiting slip clutch with adjustable settings that protect driveline components from shock and excessive loads.

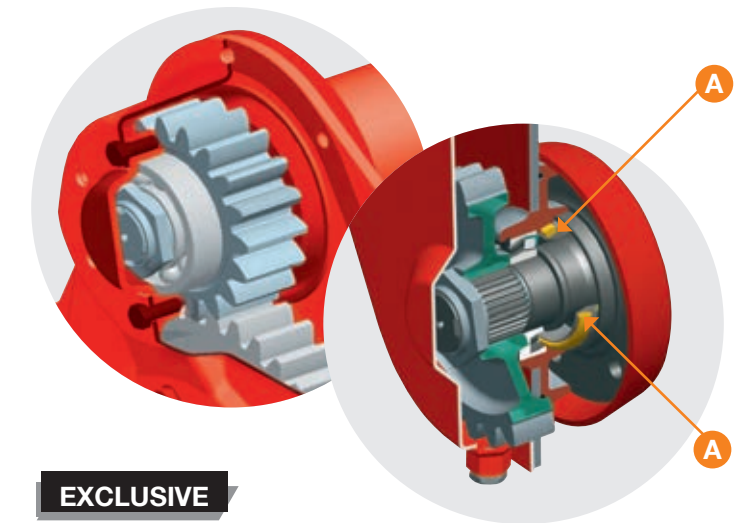

EXCLUSIVE

RELIABLE ROTOR DRIVE

The power is transmitted to the large-diameter rotor through an all gear drive. Gears are made from case-hardened steel and run in an oil bath for an extremely long service life. The advantage: drive pinions are held in place **by bearings on both sides**, which provide improved support to the input pinion and maintain proper gear lash for excellent reliability. The rotor drive seal utilizes the most advanced sealing method available, a two-piece metallic face seal **A** for superior performance in difficult service applications.



A HITCH FRAME THAT LASTS

A strong build makes the hitch frame very resistant to wear and shocks. The multiple position and telescopic coupling points adapt well to various tractors.

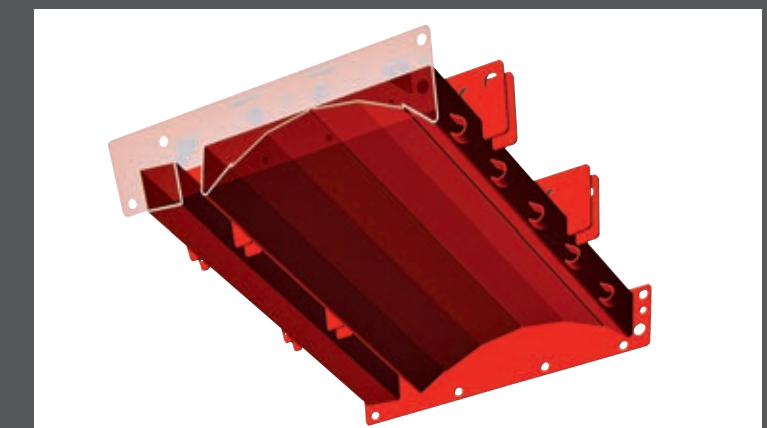

A SOLID BOX FRAME

The heavy-gauge box section crossmember acts as a one-piece frame. This offers improved rigidity, even in the most difficult conditions. In rocky conditions, the machine's outer appearance is protected due to the double-skin hood.

A ROTOR TO MATCH YOUR CULTIVATION METHOD

The unmatched versatility of KUHN power tillers comes with a wide choice of tools for different tillage applications, production systems or crop residue incorporation.

CULTIROTOR (C-BLADE): Efficient residue mixing



- Incorporation of cover crops and crop residues
- Plowing up of pastures and old forage crop ground
- Multi-purpose applications

The C-blade is equipped with curved blades efficient at mixing while producing a uniform finish. The six blades per flange offer good soil engagement and reduced power consumption. The blades are attached to the rotor using counter flanges for increased durability in hard and rocky soil. "C" blades are standard.

CULTIPLow: Increased blade numbers for maximized crumbling



- Secondary tillage of hard, dry, clay soils
- Seedbed preparation in min-till applications
- Reduces formation of "plow pans"
- Fine seedbed preparation for spring-sown crops

The high density and trailing blade position of the Cultiplow rotor maximizes the crumbling and reduction of soil clods while limiting the risks of clogging the rotor. The left and right angles of the blades provide good soil leveling by moving soil side-to-side.

CULTITILLER: Straight blades for maximum effect



- Secondary tillage applications
- Min-till primary tillage
- For rocky conditions
- Reduces formation of "plow pans"
- Incorporation of short crop residues

The leading tine position of the Cultitiller rotor lifts and cuts. Alternately left and right angled tines provide good soil leveling by moving soil side to side. With 40% more free blades than the Cultiplow, the Cultitiller rotor provides superior performance in diversified conditions such as wet, sticky soils, higher residue, and trash conditions.

QUICK-RELEASE SYSTEMS: Because time is money

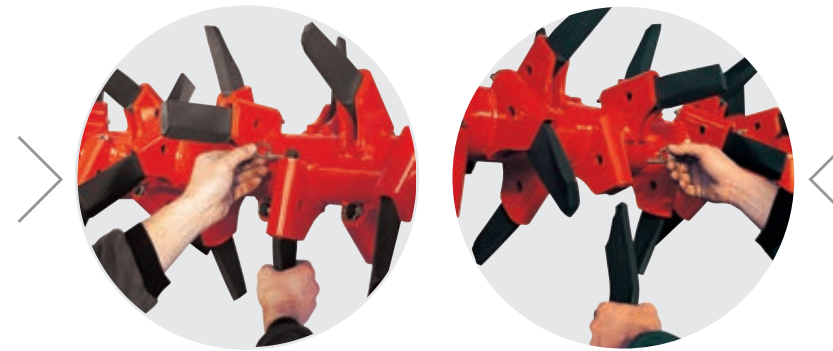

EXCLUSIVE

FAST-FIT® ON CULTITILLER

This quick-release blade system is exclusively available from KUHN. Each blade is secured with a linchpin. The scabbard-type fit holds them in place. In this way, all blades can be replaced in just a few minutes.

SIMPLIFIED ROTOR REMOVAL AND REPLACEMENT

Both ends of the rotor are secured in keystone mounts. This provides rapid removal and self-aligning reinstallation. Thus, you can quickly replace the complete rotor or facilitate the tool exchange on a dismantled rotor. This is especially useful for commercial operations with small tillage windows.

CULTIPLow: EASY-FIT

On Cultiplow models, the Easy-Fit quick-release blade system is the system of choice to make your life easier. Each blade can be removed and reinstalled by loosening and tightening only one attachment bolt.





POWER TILLERS EL 402 R

SMOOTH, CONSISTENT SEEDBED FOR EASY PLANTING

Designed, manufactured, and proven for large field crop and specialty operations, the EL 402 R is commercial in every sense of the word. The 22" diameter CultiRotor with industry-leading DuraKUHN blades, coupled with the unique triple cooling gearbox design, keeps the machine running in the field under all conditions to adapt to tight tillage windows.

POWER TILLERS EL 282

COMMERCIAL-GRADE TOUGH

Designed for difficult tillage operations on high power tractors up to 270 horsepower, these tillers are tailored for high acreage vegetable and field crop operations. Outstanding features of the EL 282, including a durable frame and chassis, innovative drivetrain, and easy adjustments and maintenance, make it an all-purpose tool for operators who require the most from a high-productivity tiller, hour after hour, day after day.



EXCLUSIVE AN UNRIVALED SIDE GEARBOX

- All pinions in the gearbox are supported on both sides by tapered roller bearings
- The large gear profile used is unrivaled in the industry
- The double drive (design similar to the planetary gear train) ensures a smoother and more efficient drive than with two individual gearboxes: an exclusive KUHN feature
- An integrated pump for oil circulation ensures both gearwheel lubrication and gearbox cooling. The large oil tank surface allows efficient evacuation of heat without requiring a delicate radiator and fan system that could easily become clogged or damaged
- High performance sealing: the rotor drive flange is fitted with the best sealing system available, a metallic face seal for unequaled performance and long life

**Applies to both the EL 282 and 402 R models.*



HIGH-CAPACITY HEADSTOCK

The robust hitch frame is designed for intensive use. Side struts reinforce the framework on machines more than 9'10" wide. The linkage is designed for Cat. 3 and 4 tractors as well as for Cat. 3 and 4 quick hitches.

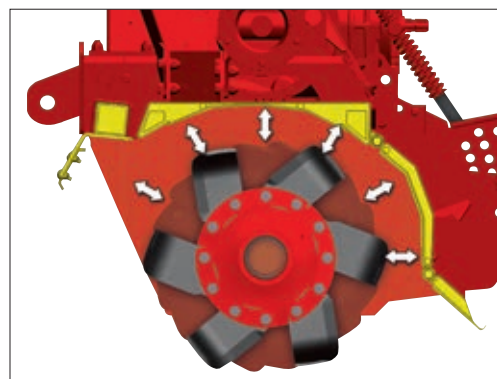

LARGE ROTOR CLEARANCE

The significant clearance between the rotor and casing reduces power requirements and facilitates soil flow. In wet conditions, the machine has less tendency for power robbing soil buildup to occur between the rotor and the body.

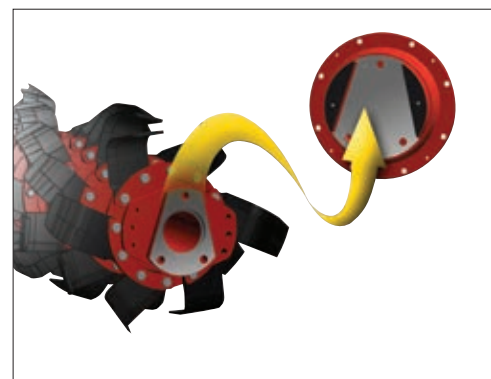

RAPID ROTOR REPLACEMENT

The EL 282 tillers are fitted with KUHN's exclusive quick change rotor system, which provides:

- Rapid exchange between the CultiRotor rotor and the Cultitiller rotor
- Safe blade replacement by separating the rotor from the chassis. It takes just a few minutes to remove the five mounting bolts and then the rotor is on the ground!



ADJUSTMENTS MADE FROM THE CAB

Every field is different. To obtain the same high standards across these differences, it is important to be able to adjust the machine quickly and easily in real time. That's why rear hood crumbling intensity and working depth are hydraulically adjustable from the tractor cab.



A JOB WELL DONE

In order to provide perfect leveling between two rows, the rollers work a wider area than the width covered by the blades, 20'3". The junction of the rollers is offset by 4" in relation to the two rotors so that the central area of the machine is perfectly even. This way the entire tilled pass is smooth.

OPTIONAL EQUIPMENT

In order to achieve the soil preparation needs of various situations, KUHN power tillers are offered with a choice of different depth control options. Easy adjustment of the roller position provides fine-tuning capabilities to maximize the effects of soil preparation.

Note: All depth control options noted may not be available for all machines. See chart on next page for more information.



DEPTH AND ROLLER ADJUSTMENT

When fitted with a roller, depth adjustment is easily performed using pins inserted into a multi-hole quadrant. The roller is free to drop, maintaining maximum contact with the soil in any condition. This optimizes firming of the seedbed and helps level the cultivated surface.



REAR WHEELS

For work at shallow depth (pasture reclamation, stubble clearing), the rear wheels can replace the roller. In transport position, these wheels pivot to the inside to reduce the machine width.



SKIDS OR FRONT WHEELS

These wheels are intended for work not requiring the surface to be entirely uniform. The front wheels are adjustable in spacing and will roll over firm soil without leaving tracks in the worked soil.

ROLLER OPTIONS

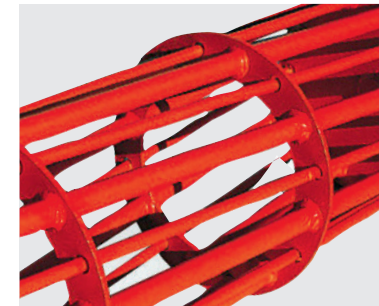

CRUMBLER ROLLER

This small 15.4" diameter roller is suitable for use on dry, non-sticky soils without an integrated seed drill. The rods can be removed, if required, to reduce clogging risks. Maintenance requirements are minimal.



MAXICRUMBLER ROLLER

The large 20" diameter of the MaxiCrumbler roller provides reduced rolling resistance and good depth control in dry, non-sticky soils without an integrated seed drill.

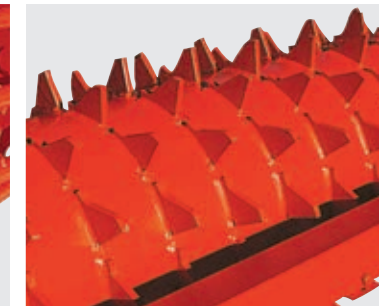

MAXIPACKER ROLLER

The large 21" MaxiPacker roller diameter reduces the rolling resistance and increases flotation. This roller can easily be combined with heavier drills. Coated scrapers are supplied as standard to maximize the service life, reduce adjustment, and improve cleaning of the roller in sticky soils.

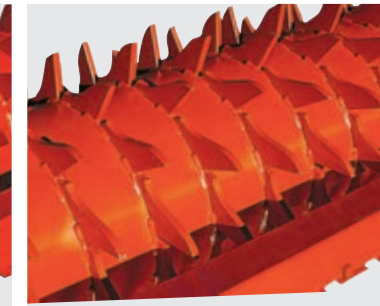

PACKER / PK2 ROLLER

This roller of 20" diameter is suitable for a wide range of soil conditions and especially recommended for clay soils that tend to crust and harden while drying. They contribute to an optimum seedbed by uniformly firming the soil while leaving loose soil on top. Suitable for use with lighter integrated drills.

	CRUMBLER ROLLER	MAXICRUMBLER ROLLER	MAXIPACKER ROLLER	PACKER	PK2 ROLLER
MODELS					
EL 82-180	◆	-	-	-	-
EL 82-205	◆	-	-	◆	-
EL 92-180	◆	-	-	-	-
EL 92-205	◆	-	-	◆	-
EL 92-230	◆	-	-	◆	-
EL 122-250	◆	◆	◆	◆	-
EL 122-300	◆	◆	◆	-	◆
EL 162-250	◆	◆	◆	◆	-
EL 162-300	◆	◆	◆	-	◆
EL 282-300	-	-	◆	-	-
EL 282-400	-	-	◆	-	-
EL 282-450	-	-	◆	-	-
EL 402 R-600	-	◆	◆	-	-

◆ = Rollers possible to attach

Please note the following machines do not have a roller option available: EL 23 Series, EL 43 Series, EL 53 Series, EL 62 Series, EL 82-130, EL 82-155.

Model Specifications

EL 23-120 EL 23-150 EL 43-105 EL 43-130 EL 43-150 EL 43-190 EL 53-100 EL 53-130 EL 53-155 EL 53-190 EL 62-130 EL 62-155 EL 62-165 EL 62-180 EL 62-210

DIMENSIONS															
Maximum PTO power	25 hp (19 kW)		40 hp (30 kW)				50 hp (37 kW)				65 hp (48 kW)				
Minimum PTO power	10 hp (7 kW)	12 hp (9 kW)	14 hp (10 kW)	16 hp (12 kW)	18 hp (13 kW)	20 hp (15 kW)	18 hp (13 kW)	24 hp (18 kW)	28 hp (21 kW)	32 hp (24 kW)	25 hp (19 kW)	30 hp (22 kW)	33 hp (24 kW)	35 hp (26 kW)	42 hp (31 kW)
Central gearbox	Single speed		Single speed				Single speed				Single speed				
PTO shaft	Standard 1 3/8" - 6-spline		Standard 1 3/8" - 6-spline				Standard 1 3/8" - 6-spline				Standard 1 3/8" - 6-spline				
PTO protection	Slip clutch		Slip clutch				Slip clutch				Slip clutch				
Rotor drive	#60 chain		#80 chain				#80H chain				Forged steel gears				
PTO speed	540 rpm		540 rpm				540 rpm				540 rpm				
Rotor speed	241 rpm		211 rpm				244 rpm				224 rpm				
Rotor diameter	15" (38 cm)		15" (38 cm)				17" (43 cm)				18" (45.7 cm)				
Number of flanges	6	7	5	6	7	9	4	5	6	8	5	6	7	9	
Number of blades per flange	4		4 (6 possible)				6				6				
Number of blades	24	28	20	24	28	36	24	30	36	48	30	36	42	42	54
Maximum working depth	4" (10 cm)		6" (15 cm)				6" (15.2 cm)				7" (17.8 cm)				
Depth control	Adjustable skids		Adjustable skids				Depth wheels				Depth wheels				
Rear hood adjustable	Chain		Chain				Springs				7 pin positions				
Progressive offset to the right	4" (10 cm)	-	8" (20.3 cm)	12" (30.5 cm)	16" (40.6 cm)	-	6" (15.2 cm)	12" (30.5 cm)	12" (30.5 cm)	-	8" (20.3 cm)				
Hitch	Cat. 0 and 1		Cat. 1				Cat. 1 and 1N				Cat. 1, 1N, and 2				
Supporting frame	-		Standard				Standard				Standard				
Depth wheels	-		Optional				Optional				Standard				
Transport width	-		-				-				55" (1.39 cm)	65" (1.65 cm)	69" (1.76 cm)	74" (1.88 cm)	87" (2.2 cm)
Working width	49" (1.25 m)	57" (1.45 m)	42" (1.07 m)	50" (1.27 m)	58" (1.48 m)	74" (1.89 m)	38" (0.97 m)	50" (1.27 m)	60" (1.52 m)	74" (1.88 m)	50" (1.28 cm)	60" (1.53 cm)	65" (1.65 cm)	70" (1.78 cm)	83" (2.1 cm)
Approximate machine weight	317 lbs (144 kg)	348 lbs (158 kg)	464 lbs (210 kg)	496 lbs (225 kg)	529 lbs (240 kg)	585 lbs (265 kg)	550 lbs (250 kg)	605 lbs (275 kg)	649 lbs (295 kg)	726 lbs (330 kg)	650 lbs (295 kg)	729 lbs (331 kg)	793 lbs (360 kg)	808 lbs (367 kg)	925 lbs (420 kg)

EL 82-130 EL 82-155 EL 82-180 EL 82-205 EL 92-180 EL 92-205 EL 92-230 EL 122-250 EL 122-300 EL 162-250 EL 162-300 EL 282-300 EL 282-400 EL 282-450 EL 402 R-600

DIMENSIONS															
Maximum PTO power	85 hp (63 kW)				100 hp (75 kW)			125 hp (93 kW)		165 hp (123 kW)		270 hp (201 kW)			400 hp (298 kW)
Minimum PTO power	33 hp (24 kW)	39 hp (29 kW)	45 hp (33 kW)	51 hp (38 kW)	45 hp (33 kW)	51 hp (38 kW)	58 hp (45 kW)	65 hp (48 kW)	75 hp (55 kW)	90 hp (66 kW)	100 hp (73 kW)	100 hp (73 kW)	130 hp (97 kW)	145 hp (108 kW)	300 hp (224 kW)
Central gearbox	Single-speed				Two-speed			Two-speed with two gearsets		Two-speed with two gearsets		Two-speed			Single-speed
PTO shaft	Standard 1 3/8" - 6-spline				Standard 1 3/8" - 6-spline			1 3/8" - 21-spline		1 3/8" - 21-spline		1 3/4" - 20-spline			1 3/4" 20-spline
Rear PTO output shaft	-				-			Standard		Standard		Standard			-
PTO protection	Slip clutch				Slip clutch			Slip clutch		Slip clutch		Slip clutch			Cam clutch on side gearboxes
Rotor drive	Forged steel gears				Forged steel gears			Forged steel gears		Forged steel gears		Forged steel gears			Forged steel gears
PTO speed	540 rpm				540 rpm			1,000 rpm (540 optional)		1,000 rpm (540 optional)		1,000 rpm			1,000 rpm
Rotor speed	212 rpm				194 and 230 rpm			258/361 & 218 rpm at 1,000 PTO rpm		202/361 & 236/296 rpm at 1,000 PTO rpm		244/287 rpm at 1,000 PTO rpm			244 rpm
Rotor diameter	21" (53 cm)				21" (53 cm)			21" (53 cm)		22"/23"/23" (55/57/57 cm)		25" (62 cm)			22" (56 cm)
Number of blades	30	36	42	48	42	48	54	60/84/56	72/100/66	60/56/84	72/100/66	72/60	96/80	108/90	144
Maximum working depth	9" (23 cm)				9" (23 cm)			9" (23 cm)		10" (25.5 cm)		11" (28 cm)			10" (25.4 cm)
Working depth adjustment	Manual				Manual			Manual		Manual		Manual			Hydraulic
Rear hood adjustable	7 pin positions				7 pin positions			Crank handle		Crank handle		Crank handle			Hydraulic
Progressive offset to the right	8" (20 cm)			-	4" (10 cm)	-		-		-		-			-
Hitch	Cat. 1, 1N and 2			Cat. 1 & 2	Cat. 1 and 2			Cat. 2		Cat. 2		Cat. 3 and 4, Quick hitch Cat. 3 and 4 compatible			Cat. 3 and 4, Quick hitch Cat. 4 compatible
Working position	Rigid				Rigid			Rigid		Rigid		Rigid			Rigid or floating (+/-2.5")
Depth wheels	Standard				Standard			Standard		Optional		Optional			-
Road lights and signaling	-		Standard - reflectors only		Standard - reflectors only			Standard - reflectors only		Standard - reflectors only		Standard - reflectors only			Standard
Transport width	66" (1.68 m)	76" (1.93 m)	85" (2.16 m)	98" (2.49 m)	85" (2.16 m)	98" (2.49 m)	109" (2.77 m)	9'1" (2.8 m)	10'8" (3.3 m)	9'1" (2.8 m)	10'9" (3.3 m)	10'9" (3.3 m)	14'1" (4.3 m)	15'7" (4.8 m)	9'10" (3.0 m)
Working width	51" (1.30 m)	61" (1.55 m)	71" (1.80 m)	81" (2.06 m)	71" (1.80 m)	81" (2.06 m)	91" (2.31 m)	8'2" (2.5 m)	9'10" (3.0 m)	8'2" (2.5 m)	9'10" (3 m)	9'10" (3.0 m)	13' (4.0 m)	14'9" (4.5 m)	20'3" (6.0 m)
Approximate machine weight	870 lbs (395 kg)	948 lbs (430 kg)	1,025 lbs (465 kg)	1,124 - 1,697 lbs (510 - 770 kg)	1,157 lbs (525 kg)	1,256 - 1,829 lbs (570 - 830 kg)	1,333 - 1,973 lbs (605 - 895 kg)	2,009 - 3,124 lbs (911 - 1,417 kg)	2,376-3,978 lbs (1,080-1,804 kg)	2,290-3,483 lbs (1,041-1,583 kg)	2,662 - 4,351 lb (1,210 - 1,974 kg)	4,023-4,824 lbs (1,825-2,188 kg)	4,729 - 6,116 lbs (2,145 - 2,774 kg)	5,148 - 6,151 lbs (2,335 - 2,790 kg)	9,623 - 10,802 lbs (4,365 - 4,900 kg)

*For additional roller weights, please contact your dealer.

COMPLEMENTARY PRODUCTS

MORE PRODUCTS TO MEET YOUR NEEDS

With over 700 models of equipment, we have the most complete implement line in the industry. Whether you have a small or large operation, we have a broad range of models and options to help fit your diverse needs.



1



2



3



4



5



6

- 1. Rollover Plows
- 2. Power Harrows
- 3. Combo Discs / Shanks
- 4. Fertilizer Spreaders
- 5. Mounted Mechanical Grain Drills
- 6. Trailed Grain Drills

For more information about your nearest KUHN dealer and other KUHN products, visit our website at

www.kuhn.com



Visit our YouTube channel to watch our latest product videos.

 <p>www.KuhnNorthAmerica.com</p>	<p>Your KUHN dealer</p>
---	-------------------------

KUHN NORTH AMERICA, INC.

Corporate Headquarters
1501 West Seventh Avenue - Brodhead, WI 53520

Information given in this document is only for informational purposes and is non-contractual. Our machines are in compliance with North American safety standards. In our literature, and for improved illustration of certain details, some safety devices may not be in operating position. When operating these machines, these devices must be operated in accordance with the requirements indicated in the operator's manuals and assembly manuals. We reserve the right to change any designs, specifications or materials listed without further notice. Machines and equipment in this document can be covered by at least one patent and/or registered design. Trademarks cited in this document may be registered in one or several countries.

Find us on   