

STANDARD EQUIPMENT

ISO Standard cabin

All-weather steel cab with 360° visibility
Safety glass windows
Rise-up type windshield wiper
Sliding fold-in front window
Sliding side window(LH)
Lockable door
Hot & cool box
Storage compartment & Ashtray
Transparent cabin roof-cover
Radio & USB Player
Handsfree mobile phone system with USB
Sun visor

Computer aided power optimization (New CAPO) system

3-power mode, 2-work mode, user mode
Auto deceleration & one-touch deceleration system
Auto warm-up system
Auto overheat prevention system

Automatic climate control

Air conditioner & heater
Defroster

Self-diagnostics system

Starting Aid (air grid heater) for cold weather

Centralized monitoring

LCD display
Engine speed or Trip meter/Accel.
Clock
Gauges
Fuel level gauge
Engine coolant temperature gauge
Hyd. oil temperature gauge
Warnings
Check Engine
Overload
Communication error
Low battery
Air cleaner clogging
Indicators
Max power
Low speed/High speed
Fuel warmer
Auto idle

Door and cab locks, one key

Two outside rearview mirrors

Air suspension seat

Pilot-operated slidable joystick

Console box height adjust system

Two front working lights

Electric horn

Batteries (2 x 12V x 100 AH)

Battery master switch

Removable clean-out screen for cooler

Automatic swing brake

Removable reservoir tank

Fuel pre-filter with fuel warmer

Boom holding system

Arm holding system

Accumulator for lowering work equipment

Electric Tranducers

Lower frame under cover (Normal)

Viscous fan clutch

Tires-dual (10.00-20-16PR)

Travel alarm

Front outrigger and rear blade

OPTIONAL EQUIPMENT

Fuel filler pump (50 L/min)

Beacon lamp

Safety lock valve for boom cylinder with overload warning device

Safety lock valve for arm cylinder

Single-acting piping kit (breaker, etc.)

Double-acting piping kit (clamshell, etc.)

Quick coupler

12 volt power outlet (24V DC to 12V DC converter)

Varjous optional Arms

Super short arm (2.0 m, 6' 7")

Short arm (2.4 m, 7' 10")

Cabin FOPS/FOG (ISO/DIS 10262 Level II)

FOPS (Falling Object Protective Structure)

FOG (Falling Object Guard)

Cabin Rops

ROPS (Roll over Protective Structure)

Cabin roof-steel cover

Cabin guard-Front

Wire net

Fine net

Cabin lights

Cabin front window rain guard

Undercarriage

Front and rear blade

Front and rear outrigger (Independent)

Front blade and rear outrigger

Tool kit

Operator suit

Rearview camera

Seat

Adjustable air suspension seat

Mechanical suspension seat with heater

Mechanical suspension seat

Tires - dual (10.00 - 20 solid)

Fenders (Mudguards)

Hi-mate (Remote Management System)

Travel pedal (2 way)

Rear Work Lamp

- * Standard and optional equipment may vary. Contact your Hyundai dealer for more information. The machine may vary according to International standards.
- * The photos may include attachments and optional equipment that are not available in your area.
- * Materials and specifications are subject to change without advance notice.
- * All imperial measurements rounded off to the nearest pound or inch.

PLEASE CONTACT

 **HYUNDAI**
HEAVY INDUSTRIES CO.,LTD.
CONSTRUCTION EQUIPMENT

Head Office
1000 BANGEOJINSUNHWAN-DORO, DONG-GU, ULSAN, 682-792, KOREA
TEL:(82)52-202-7722, 9807 FAX:(82)52-202-7720

Robex

210w-9A

With Tier 4 Interim Engine installed

MOVING YOU FURTHER

HYUNDAI HEAVY INDUSTRIES



*Photo may include optional equipment.

 **HYUNDAI**
HEAVY INDUSTRIES CO., LTD.

PRIDE AT WORK

Hyundai Heavy Industries strives to build state-of-the-art earthmoving equipment to give every operator maximum performance, more precision, versatile machine preferences, and proven quality.

Take pride in your work with Hyundai!



Robex 210w-9A

Machine Walk-Around

Engine Technology

Proven, reliable, fuel efficient, low emission and low noise
Cummins Tier 4 interim & EU stage III B engine

Hydraulic System Improvements

New patented hydraulic control for improved controllability / Improved control valve design for added efficiency and smoother operation / New auto boom and swing priority system for optimum speed / New auto power boost feature for additional power when needed / Improved arm-in and boom-down flow regeneration system for added speed and efficiency

Pump Compartment

Industry-leading, powerful, reliable Kawasaki designed, variable volume in-line axial piston pumps
New compact solenoid block equipped with 4 solenoid valves, 1 EPPR valve, 1 check valve accumulator and pilot filter - controls creep, arm regeneration cut, power boost, boom priority, safety lock

Enhanced Operator Cab

Improved Visibility

Enlarged cab with improved visibility / See-through upper skylight for visibility and ventilation
Larger right-side glass, now one piece, for better right visibility
Safety glass windows on all sides - less expensive than (polycarbonate) and won't scratch or fade
Closeable sunshade for operator convenience / Reduced front window seam for improved operator view

Improved Cab Construction

New steel tube construction for added operator safety, protection and durability
New window open/close mechanism designed with cable and spring lift assist and single latch release

Improved Suspension Seat / Console Assembly

Ergonomic joysticks with auxiliary control buttons for attachment use. Now with new sleek styling
Air suspension seat (standard) or optional air ride suspension with heat
New joystick consoles - now adjustable in height by pushing the button
Integrated seat with consoles - reduce the operator fatigue

Advanced 7" Color Cluster with Touch Screen

New Color LCD Display with easy to read digital gauges for hydraulic oil temperature, water temperature, and fuel. Simplified design makes adjustment and diagnostics easier. Also, new enhanced features such as rear-view camera are integrated into monitor.
3 power modes : (P) Power, (S) Standard, (E) Economy, 2 work modes : Dig & Attachment, (U) User mode for operator preference
Enhanced self-diagnostic features with GPS download capability
One pump flow or two pump flow for optional attachment is now selectable through the cluster /
New anti-theft system with password capability
Boom speed and arm regeneration are selectable through the monitor.
Auto power boost is now available - selectable (on/off) through the monitor.
Powerful air conditioning and heat with auto climate control

RMS (Remote Management System)

works through GPS/satellite technology to ultimately provide better customer service and support.

Improved Steering Column

Slim-profile steering column capable of telescoping 60 mm and tilting 30 degrees



*Photo may include optional equipment.

PRECISION

Innovative hydraulic system technologies make the 9A series excavator fast, smooth and easy to control.



*Photo may include optional equipment.

Computer Aided Power

The engine horsepower and hydraulic horsepower together in unison through the advanced CAPO(Computer Aided Power Optimization) system, flow for the job at hand. Operator can set their own preferences for boom or swing priority, power mode selection and optional work tools at the touch of a button.

The CAPO system also provides complete self diagnostic features and digital gauges for important information like hydraulic oil temperature, water temperatures and fuel level. This system interfaces with multiple sensors placed throughout the hydraulic system as well as the electronically controlled engine to provide the optimum level of engine power and hydraulic flow.

Power Mode

P (Power Max) mode maximizes machine speed and power for mass production. S (Standard) mode provides a reduced, fixed rpm for optimum performance and improved fuel economy. For maximum fuel savings and improved control, E (Economy) mode provides precise flow and engine power based on load demand. Three unique power modes provide the operator with custom power, speed and fuel economy.

Work Mode

The work mode allows the operator to select single flow attachments like a hydraulic breaker or bi-directional flow attachments like a crusher. Flow settings unique to each attachment can be programmed from within the cluster.

User Mode

Some jobs require more precise machine settings. Using the versatile U (User) mode, the operator can customize engine speed, pump output, idle speed and other machine settings for the job at hand.

Improved Hydraulic System



To achieve optimum precision, Hyundai redesigned the hydraulic system to provide the operator with super fine touch and improved controllability. Improved pump flow control reduces flow when controls are not being used to minimize fuel consumption.

Improved spool valves in the control valve are engineered to provide more precise flow to each function with less effort.

Improved hydraulic valves, precision-designed variable volume piston pumps, fine-touch pilot controls, and enhanced travel functions make any operator running a 9A series look like a smooth operator. Newly improved features

include arm-in and boom-down flow regeneration, improved control valve technology and innovative auto boom and swing priority for optimal performance in any application.

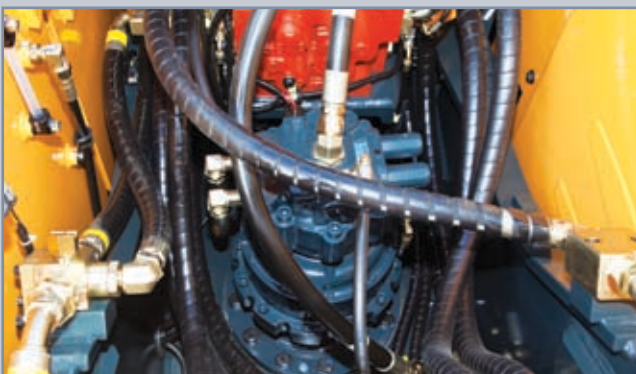

Auto Boom-swing Priority

This smart function automatically and continuously looks the ideal hydraulic flow balance for the boom and swing motions of the machine. The advanced CAPO system monitors the hydraulic system and adjusts its settings to maximize performance and productivity.

PERFORMANCE

9A series is designed for maximum performance to keep the operator working productively.

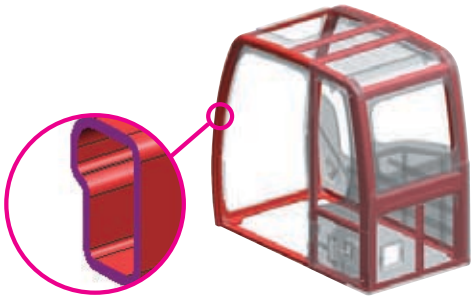

*Photo may include optional equipment.



Fully Independent Outrigger System

R210W-9A can be equipped with four independent outriggers (front and rear) or two independent outriggers and a dozer blade (front or rear). Each outrigger and the dozer blade are controlled by a switch and the dozer lever. Each outrigger is equipped with cylinder guards for added protection.



Structure Strength

The 9A series cabin structure has been fitted with stronger but slimmer tubing for more safety and improved visibility. Low-stress, high strength steel is integrally welded to form a stronger, more durable upper and lower frame. Structural integrity was tested by way of FEM (Finite Elements Method) analysis and long-term durability tests. The optional ROPS (Roll Over Protective Structure) cab can be equipped to enhance operator safety.

New and Improved Travel System

Auto cruise control system reduces operator fatigue by maintaining a fixed speed when driving distances. A new auto ram lock system is available to improve operating safety. A new creep speed travel system improves maneuverability and fine control. A new optional forward / reverse travel pedal control allows operators to choose to use the travel pedal control while in work mode or lever control when in travel mode.

Cummins QSB6.7 Engine

QSB6.7 engine above 174 hp (130 kW) meet Tier 4 Interim/Stage III B emissions regulation with the combination of a proven cooled-EGR system, High Pressure Common Rail (HPCR) fuel system, Cummins Diesel Oxidation Catalyst. The QSB6.7 is also complemented by patented VGT™ Turbocharger, which continuously varies the airflow boost to precisely match engine rpm and load demands for optimal performance. This engine features the Cummins Direct Flow™ air filter, which has a smaller profile than radial filters. The result is an engine that fits into existing equipment, delivers better performance with faster cycle times and better fuel economy than the previous model.



PREFERENCE

Operating a 9A series is unique to every operator. Operators can fully customize their work environment and operating preferences to fit their individual needs.



*Photo may include optional equipment.



Wide Cabin with Excellent Visibility

The newly designed cabin was conceived for more space, a wider field of view and operator comfort. Special attention was given to a clear, open and convenient interior with plenty of visibility on the machine surroundings and the job at hand. This well balanced combination of precision aspects put the operator in the perfect position to work safely and securely.

Operator Comfort

In 9A series cabin you can easily adjust the seat, console and armrest settings to best suit your comfort level. The seat integrated with console absorb console vibration by seat suspension and reduce operator's fatigue. New joystick consoles are adjustable in height by pushing the button. Other preference settings that add to overall operator comfort include the fully automatic high capacity airconditioning system, transparent polycarbonate glass sun roof, large and easy to control sun visor, and the Radio / USB player.



Reduced Stress

Work is stressful enough. Your work environment should be stress free. Hyundai's 9A series provides improved cab amenities, additional space and a comfortable seat to minimize stress to the operator. A powerful climate control system provides the operator with optimum air temperature. An advanced audio system with USB player, AM/FM stereo and MP3 capabilities, plus remotely located controls is perfect for listening to music favorites. Operators can even talk on the phone with the hands-free cell phone feature. Also, the newly designed optional remote control offers mobile bluetooth-handsfree and radio cable-handsfree function.



Smart Key System (Option)

User authentication and anti-theft system are reinforced with smart key system. This allows the operator to start the engine with the push of a starter button rather than inserting a key into the ignition.



Operator - Friendly Cluster

The advanced new cluster with 7 inch wide color LCD with touch screen and toggle switch allows the operator to select his personal machine preferences. Power and work mode selection, self diagnostics, optional rear-view camera, maintenance check lists, start-up machine security, and video functions were integrated into the cluster to make the machine more versatile and the operator more productive.

The newly applied FM transmitter application transmits signal to USB & Radio player with the same frequency as cluster. The player outputs the audio through the internal speaker in the cab. The video & firmware updates are possible with USB host support and an adjustable cluster hinge bracket improves cluster visibility.

Monitor Tilt Range



Horizontal
Total : 15°



Vertical
Total : 30°



PROFITABILITY

9A series is designed to maximize profitability through improved efficiencies, enhanced service features and longer life components.



*Photo may include optional equipment.



Fuel Efficiency

9A series excavators are engineered to be extremely fuel efficient. New innovations like the fan clutch, two-stage auto decel system and the new economy mode help to conserve fuel and reduce the impact on the environment.

Hi-mate (Remote Management System)

Hi-mate, Hyundai's proprietary remote management system, provides operators and dealer service personnel access to vital service and diagnostic information on the machine from any computer with internet access. Users can pinpoint machine location using digital mapping and set machine work boundaries, reducing the need for multiple service calls. Hi-mate saves time and money for the owner and dealer by promoting preventative maintenance and reducing machine downtime.

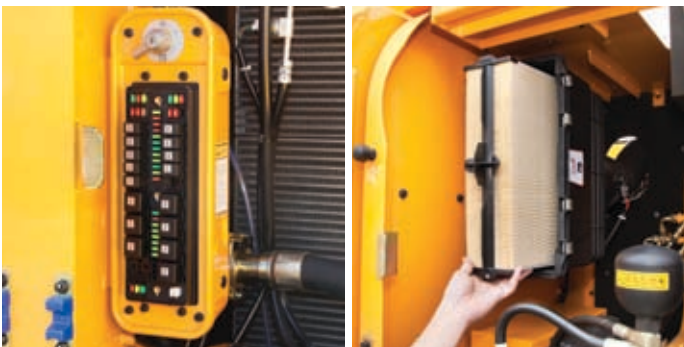

Easy Access

Ground-line access to filters, lube fittings, fuses, machine computer components and wide open compartments makes service more convenient on the 9A series.



Long-Life Components

9A series excavators were designed with bushings designed for long-life lube intervals (250 hrs) & polymer shims (wear resistant, noise reducing), long-life hydraulic filters (1,000hrs), long-life hydraulic oil (5,000hrs), more efficient cooling systems and integrated preheating systems which extend service intervals, minimize operating costs and reduce machine down time.

Specifications

ENGINE

MODEL		Cummins QSB 6.7	
Type		Water-cooled, 4-cycle diesel, 6-cylinder in-line, Direct injection, Turbocharged, Charge air cooled, Low emission	
Rated flywheel horsepower	SAE	J1995 (gross)	173 HP (129kW) at 2,000 rpm
		J1349 (net)	163 HP (121kW) at 2,000 rpm
	DIN	6271/1 (gross)	175 PS (129kW) at 2,000 rpm
		6271/1 (net)	165 PS (121kW) at 2,000 rpm
Max. torque		81.7 kgf-m(591 lbf-ft) at 1,500 rpm	
Bore X stroke		107 x 124 mm (4.2" x 4.9")	
Piston displacement		6,700 cc (409 in ³)	
Batteries		2 x 12 V x 100 AH	
Starting motor		24V-4.8kW	
Alternator		24V-95Amp	

HYDRAULIC SYSTEM

MAIN PUMP	
Type	Two variable displacement piston pumps
Rated flow	2 X 216.5 L /min (57.2 US gpm/47.6 UK gpm)
Sub-pump for pilot circuit	Gear pump
Cross-sensing and fuel saving pump system	

HYDRAULIC MOTORS

Travel	Variable displacement with brake valve
Swing	Axial piston motor with automatic brake

RELIEF VALVE SETTING

Implement circuits	350 kgf/cm ² (4,980 psi)
Travel	380 kgf/cm ² (5,400 psi)
Power boost (boom, arm, bucket)	380 kgf/cm ² (5,400 psi)
Swing circuit	265 kgf/cm ² (3,770 psi)
Pilot circuit	40 kgf/cm ² (570 psi)
Service valve	Installed

HYDRAULIC CYLINDERS

No. of cylinder bore X stroke	Boom : 2-120 x 1,290 mm (4.7" x 50.8")
	Arm : 1-140 x 1,510 mm (5.5" x 59.4")
	Bucket : 1-125 x 1,055 mm (4.9" x 41.5")
	Blade : 2-120 x 226 mm (4.7" x 8.9")
	Outrigger : 2-130 x 427 mm (5.1" x 16.8")

DRIVES & BRAKES

4-wheel hydrostatic drive. Constant mesh, helical gear transmission provides 2 forward and reverse travel speeds.

Max. drawbar pull	11,900 kgf (26,240 lbf)	
Travel speed	1st	9.2 km/h (5.7 mph)
	2nd	35 km/h (21.7 mph)
Gradeability	31.5° (61 %)	

Parking brake : Independent dual brake, front and rear axle full hydraulic power brake.

- Spring released and hydraulic applied wet type multiple disk brake.

- Transmission is locked at neutral position for parking, automatically.

CONTROL

Pilot pressure operated joysticks and pedals with detachable lever provide almost effortless and fatigueless operation.

Pilot control	Two joysticks with one safety lever (LH): Swing and arm, (RH): Boom and bucket (ISO)
Engine throttle	Electric, Dial type
Lights	Two lights mounted on the boom, one under the battery box and one under the cabin

AXLE & WHEEL

Full floating front axle is supported by center pin for oscillation. It can be locked by oscillation lock cylinders. Rear axle is fixed on the lower chassis.

Tires	10.00-20-16PR, Dual(tube type)
(optional)	10.00-20, Dual(solid type)

SWING SYSTEM

Swing motor	Fixed displacement axial pistons motor
Swing reduction	Planetary gear reduction
Swing bearing lubrication	Grease-bathed
Swing brake(option)	Multi wet disc(pin lock type)
Swing speed	9.7 rpm

STEERING SYSTEM

Hydraulically actuated, orbitrol type steering system actuates on front wheels through the steering cylinders.

Min. turning radius	6,690 mm(21' 11")
---------------------	-------------------

COOLANT & LUBRICANT CAPACITY

	liter	US gal	UK gal
Re-filling			
Fuel tank	310.0	81.9	68.2
Engine coolant	35.0	9.2	7.7
Engine oil	23.1	6.1	5.1
Swing device - gear oil	5	1.3	1.1
Axle	Front	14.6	3.9
	Rear	18.5	4.9
Hydraulic system (including tank)	340.0	89.8	74.8
Hydraulic tank	165.0	43.6	36.3

UNDERCARRIAGE

Reinforced box-section frame is all-welded, low-stress.

Dozer blade and outriggers are available. A pin-on design.

Dozer blade	A very useful addition for leveling and back filling or clean-up work.
Outrigger	Indicated for max. operation stability when digging and lifting. Can be mounted on the front/or the rear.

OPERATING WEIGHT (APPROXIMATE)

Operating weight, including 5,650mm (18' 6") boom, 2,920mm (9' 7") arm, SAE heaped 0.80m³ (1.05yd³) backhoe bucket, lubricant, coolant, full fuel tank, hydraulic tank and the standard equipment.

MAJOR COMPONENT WEIGHT	
Upperstructure	5,240kg (11,550 lb)
Mono boom(with arm cylinder)	1,790kg (3,950 lb)

OPERATING WEIGHT	
Front outrigger and rear blade	20,500kg (45,200 lb)
Front and rear outrigger	20,600kg (45,400 lb)
Front blade and rear outrigger	20,500kg (45,200 lb)

BUCKETS

All buckets are welded with high-strength steel.

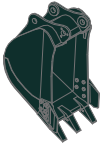

0.51 (0.67)



0.80 (1.05)
0.87 (1.14)
0.92 (1.20)

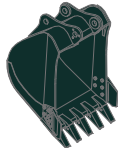

1.10 (1.44)
1.20 (1.57)

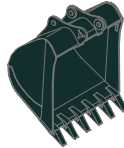

1.34 (1.75)



◆ 0.74 (0.97)
0.90 (1.18)
1.05 (1.37)



⊙ 0.87 (1.14)

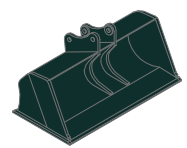

■ 0.75 (0.98)

SAE heaped m³ (yd³)

Capacity m ³ (yd ³)		Width mm (in)		Weight kg (lb)	Recommendation m (ft-in)		
SAE heaped	CECE heaped	Without sidecutters	With sidecutters		5,650 (18' 6") Boom		
					2,000 (6' 7") Arm	2,400 (7' 10") Arm	2,920 (9' 7") Arm
0.51 (0.67)	0.45(0.59)	700(27.6)	820(32.3)	570(1,260)	●	●	●
0.80 (1.05)	0.70(0.92)	1,000(39.4)	1,120(44.1)	700(1,540)	●	●	●
0.87 (1.14)	0.75(0.98)	1,090(42.9)	1,210(47.6)	740(1,630)	●	●	●
0.92 (1.20)	0.80(1.05)	1,150(45.3)	1,270(50.0)	770(1,700)	●	●	■
1.10 (1.44)	0.96(1.26)	1,320(52.0)	1,440(56.7)	830(1,830)	●	■	▲
1.20 (1.57)	1.00(1.31)	1,400(55.1)	1,520(59.8)	850(1,870)	●	■	—
1.34 (1.75)	1.15(1.50)	1,550(61.0)	1,670(65.7)	920(2,030)	■	▲	—
◆ 0.74 (0.97)	0.65(0.85)	985(38.8)	-	770(1,700)	●	●	●
◆ 0.90 (1.18)	0.80(1.05)	1,095(43.1)	-	810(1,790)	●	●	■
◆ 1.05 (1.37)	0.92(1.20)	1,290(50.8)	-	890(1,960)	●	■	▲
⊙ 0.87 (1.14)	0.75(0.98)	1,140(44.9)	-	900(1,980)	●	●	■
■ 0.75 (0.98)	0.65(0.85)	1,790(70.5)	-	880(1,940)	●	●	■

◆ Heavy duty bucket ⊙ Rock-heavy duty bucket
■ Slope finishing bucket

● : Applicable for materials with density of 2,000 kg /m³ (3,370 lb/ yd³) or less
■ : Applicable for materials with density of 1,600 kg /m³ (2,700 lb/ yd³) or less
▲ : Applicable for materials with density of 1,100 kg /m³ (1,850 lb/ yd³) or less

ATTACHMENT

Booms and arms are welded with a low-stress, full-box section design. 5.65m (18' 6") boom and 2.0m (6' 7"), 2.4m (7' 10"), 2.92m (9' 7") arms.

DIGGING FORCE

Arm	Length	mm (ft-in)	2,000 (6' 7")	2,400 (7' 10")	2,920 (9' 7")	Remarks
	Weight	kg (lb)	975 (2,150)	1,045 (2,300)	1,095 (2,410)	
Bucket digging force	SAE	kN	133.4 [144.8]	133.4 [144.8]	133.4 [144.8]	[]: Power Boost
		kgf	13600 [14770]	13600 [14770]	13600 [14770]	
		lbf	29980 [32550]	29980 [32550]	29980 [32550]	
	ISO	kN	152.0 [165.0]	152.0 [165.0]	152.0 [165.0]	
		kgf	15500 [16830]	15500 [16830]	15500 [16830]	
		lbf	34170 [37100]	34170 [37100]	34170 [37100]	
Arm crowd force	SAE	kN	144.2 [156.5]	119.6 [129.9]	102.0 [110.7]	
		kgf	14700 [15960]	12200 [13250]	10400 [11290]	
		lbf	32410 [35190]	26900 [29210]	22930 [24900]	
	ISO	kN	151.0 [164.0]	125.5 [136.3]	106.9 [116.1]	
		kgf	15400 [16720]	12800 [13900]	10900 [11830]	
		lbf	33950 [36860]	28220 [30640]	24030 [26090]	

Note: Arm weight includes bucket cylinder, linkage, and pin

Dimensions & Working Range

R210W-9A DIMENSIONS

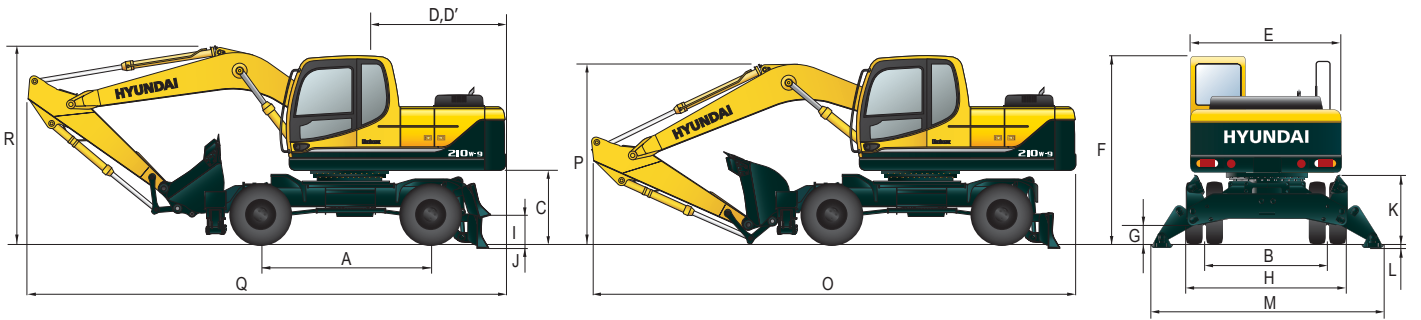

Unit : mm (ft · in)

A	Wheel base	2,800 (9' 2")
B	Tread	1,914 (6' 3")
C	Ground clearance of counterweight	1,305 (4' 3")
D	Tail swing radius	2,800 (9' 2")
D'	Rear-end length	2,765 (9' 1")
E	Overall width of upperstructure	2,530 (8' 4")
F	Overall height of cap	3,180 (10' 5")
G	Min. ground clearance	345 (1' 2")
H	Overall width of lower structure	2,495 (8' 2")
I	Ground clearance of blade up	445 (1' 6")
	Depth of blade down	120 (0' 5")
J	Height of blade	610 (2' 0")
	Width of blade	2,490 (8' 2")
K	Ground clearance of outrigger up	1,220 (4' 0")
L	Depth of outrigger down	120 (0' 5")
M	Overall width of outrigger	3,770 (12' 4")

Unit : mm (ft · in)

Boom length	5,650 (18' 6")			
Arm length	2,000 (6' 7")	2,400 (7' 10")	2,920 (9' 7")	
O	Shipping length of boom	9,680 (31' 9")	9,570 (31' 5")	9,500 (31' 2")
P	Shipping height of boom	3,350 (10' 12")	3,240 (10' 8")	3,150 (10' 4")
Q	Traveling length of boom	9,630 (31' 7")	9,550 (31' 4")	9,520 (31' 3")
R	Traveling height of boom	3,530 (11' 7")	3,460 (11' 4")	3,440 (11' 3")

R210W-9A WORKING RANGE

Unit : mm (ft · in)

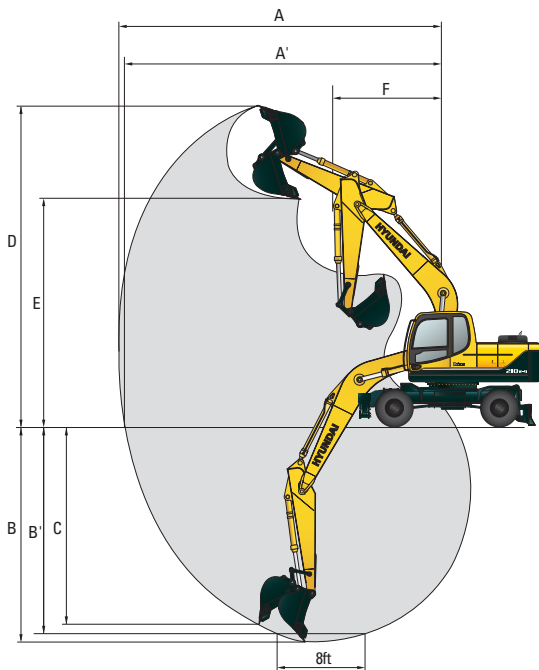













Boom length	5,650 (18' 6") mono			
Arm length	2,000 (6' 7")	2,400 (7' 10")	2,920 (9' 7")	
A	Max. digging reach	9,110 (29' 11")	9,480 (31' 1")	9,960 (32' 8")
A'	Max. digging reach on ground	8,870 (29' 1")	9,260 (30' 5")	9,750 (32' 0")
B	Max. digging depth	5,480 (18' 0")	5,880 (19' 3")	6,380 (20' 11")
B'	Max. digging depth (8' level)	5,240 (17' 2")	5,670 (18' 7")	6,210 (20' 4")
C	Max. vertical wall digging depth	4,970 (16' 4")	5,470 (17' 11")	5,990 (19' 8")
D	Max. digging height	9,500 (31' 2")	9,730 (31' 11")	10,000 (32' 10")
E	Max. dumping height	6,670 (21' 11")	6,900 (22' 8")	7,160 (23' 6")
F	Min. swing radius	3,700 (12' 2")	3,620 (11' 11")	3,580 (11' 9")

Lifting Capacity













R210W-9A

 Rating over-front  Rating over-side or 360 degree

Boom : 5.65 m (18' 6") / Arm : 2.40 m (7' 10") / Bucket : 0.80 m³ (1.05 yd³) SAE heaped / Front outrigger and rear dozer blade down

Load point height m (ft)		Load radius										At max. reach			
		1.5 m (5 ft)		3.0 m (10 ft)		4.5 m (15 ft)		6.0 m (20 ft)		7.5 m (25 ft)		Capacity		Reach	
														m (ft)	
7.5 m	kg												*3810	3690	7.34
(25 ft)	lb												*8400	8140	(24.1)
6.0 m	kg							*4150	*4150				*3910	2890	8.31
(20 ft)	lb							*9150	*9150				*8620	6370	(27.3)
4.5 m	kg					*5500	*5500	*4710	*4710	*4390	3350		*4050	2500	8.87
(15 ft)	lb					*12130	*12130	*10380	*10380	*9680	7390		*8930	5510	(29.1)
3.0 m	kg					*7330	*7330	*5550	4700	*4760	3230		*4230	2320	9.10
(10 ft)	lb					*16160	*16160	*12240	10360	*10490	7120		*9330	5110	(29.9)
1.5 m	kg					*8950	6970	*6390	4450	*5180	3110		*4430	2300	9.05
(5 ft)	lb					*19730	15370	*14090	9810	*11420	6860		*9770	5070	(29.7)
Ground	kg			*9840	*9840	*9780	6720	*6980	4290	*5480	3030		*4640	2440	8.70
Line	lb			*21690	*21690	*21560	14820	*15390	9460	*12080	6680		*10230	5380	(28.5)
-1.5 m	kg	*10680	*10680	*14730	14050	*9850	6680	*7130	4230				*4830	2820	8.00
(-5 ft)	lb	*23550	*23550	*32470	30970	*21720	14730	*15720	9330				*10650	6220	(26.2)
-3.0 m	kg	*15190	*15190	*13270	*13270	*9140	6780	*6600	4300				*4870	3730	6.84
(-10 ft)	lb	*33490	*33490	*29260	*29260	*20150	14950	*14550	9480				*10740	8220	(22.4)
-4.5 m	kg			*10270	*10270	*7070	*7070								
(-15 ft)	lb			*22640	*22640	*15590	*15590								

Boom : 5.65 m (18' 6") / Arm : 2.40 m (7' 10") / Bucket : 0.80 m³ (1.05 yd³) SAE heaped / Front outrigger and rear dozer blade up

Load point height m (ft)		Load radius										At max. reach			
		1.5 m (5 ft)		3.0 m (10 ft)		4.5 m (15 ft)		6.0 m (20 ft)		7.5 m (25 ft)		Capacity		Reach	
														m (ft)	
7.5 m	kg												*3810	2180	7.34
(25 ft)	lb												*8400	4810	(24.1)
6.0 m	kg							*4150	3110				3310	1630	8.31
(20 ft)	lb							*9150	6860				7300	3590	(27.3)
4.5 m	kg					*5500	4770	*4710	2930	3840	1900		2890	1350	8.87
(15 ft)	lb					*12130	10520	*10380	6460	8470	4190		6370	2980	(29.1)
3.0 m	kg					*7330	4220	5400	2690	3730	1800		2700	1220	9.10
(10 ft)	lb					*16160	9300	11900	5930	8220	3970		5950	2690	(29.9)
1.5 m	kg					8100	3780	5140	2470	3600	1690		2680	1200	9.05
(5 ft)	lb					17860	8330	11330	5450	7940	3730		5910	2650	(29.7)
Ground	kg			*9840	6700	7850	3570	4970	2320	3520	1610		2840	1280	8.70
Line	lb			*21690	14770	17310	7870	10960	5110	7760	3550		6260	2820	(28.5)
-1.5 m	kg	*10680	*10680	*14730	6770	7800	3530	4920	2270				3270	1520	8.00
(-5 ft)	lb	*23550	*23550	*32470	14930	17200	7780	10850	5000				7210	3350	(26.2)
-3.0 m	kg	*15190	*15190	*13270	6960	7900	3620	4990	2330				4290	2080	6.84
(-10 ft)	lb	*33490	*33490	*29260	15340	17420	7980	11000	5140				9460	4590	(22.4)
-4.5 m	kg			*10270	7350	*7070	3880								
(-15 ft)	lb			*22640	16200	*15590	8550								

1. Lifting capacity is based on SAE J1097, ISO 10567.

2. Lifting capacity of the Robex Series does not exceed 75% of the tipping load with the machine on firm, level ground or 87% of full hydraulic capacity.

3. The load point is a hook located on the back of the bucket.













4. (*) indicates the load limited by hydraulic capacity.

Lifting Capacity













R210W-9A

 Rating over-front  Rating over-side or 360 degree

Boom : 5.65 m (18' 6") / Arm : 2.92 m (9' 7") / Bucket : 0.80 m³ (1.05 yd³) SAE heaped / 4 outrigger down

Load point height m (ft)		Load radius										At max. reach			
		1.5 m (5 ft)		3.0 m (10 ft)		4.5 m (15 ft)		6.0 m (20 ft)		7.5 m (25 ft)		Capacity		Reach	
														m (ft)	
9.0 m	kg												*3410	*3410	6.52
(30 ft)	lb												*7520	*7520	(21.4)
7.5 m	kg												*3470	*3470	7.96
(25 ft)	lb												*7650	*7650	(26.1)
6.0 m	kg									*2690	*2690		*3580	3140	8.85
(20 ft)	lb									*5930	*5930		*7890	6920	(29.0)
4.5 m	kg							*4210	*4210	*3980	*3980		*3720	2770	9.37
(15 ft)	lb							*9280	*9280	*8770	*8770		*8200	6110	(30.7)
3.0 m	kg			*10720	*10720	*6550	*6550	*5090	*5090	*4410	3970		*3890	2600	9.59
(10 ft)	lb			*23630	*23630	*14440	*14440	*11220	11220	*9720	8750		*8580	5730	(31.5)
1.5 m	kg			*8900	*8900	*8350	*8350	*6020	5510	*4900	3820		*4080	2570	9.54
(5 ft)	lb			*19620	*19620	*18410	*18410	*13270	12150	*10800	8420		*8990	5670	(31.3)
Ground	kg			*10210	*10210	*9470	8490	*6730	5290	*5300	3710		*4290	2710	9.21
Line	lb			*22510	*22510	*20880	18720	*14840	11660	*11680	8180		*9460	5970	(30.2)
-1.5 m	kg	*9470	*9470	*13480	*13480	*9820	8360	*7060	5190	*5440	3660		*4500	3060	8.56
(-5 ft)	lb	*20880	*20880	*29720	*29720	*21650	18430	*15560	11440	*11990	8070		*9920	6750	(28.1)
-3.0 m	kg	*12940	*12940	*14070	*14070	*9430	8410	*6830	5220				*4640	3860	7.50
(-10 ft)	lb	*28530	*28530	*31020	*31020	*20790	18540	*15060	11510				*10230	8510	(24.6)
-4.5 m	kg			*11670	*11670	*7990	*7990								
(-15 ft)	lb			*25730	*25730	*17610	*17610								

Boom : 5.65 m (18' 6") / Arm : 2.92 m (9' 7") / Bucket : 0.80 m³ (1.05 yd³) SAE heaped / 4 outrigger up

Load point height m (ft)		Load radius										At max. reach			
		1.5 m (5 ft)		3.0 m (10 ft)		4.5 m (15 ft)		6.0 m (20 ft)		7.5 m (25 ft)		Capacity		Reach	
														m (ft)	
9.0 m	kg												*3410	2840	6.52
(30 ft)	lb												*7520	6260	(21.4)
7.5 m	kg												*3470	1870	7.96
(25 ft)	lb												*7650	4120	(26.1)
6.0 m	kg									*2690	2010		2970	1420	8.85
(20 ft)	lb									*5930	4430		6550	3130	(29.0)
4.5 m	kg							*4210	2990	3880	1930		2610	1190	9.37
(15 ft)	lb							*9280	6590	8550	4250		5750	2620	(30.7)
3.0 m	kg			*10720	7970	*6550	4340	*5090	2730	3740	1810		2450	1070	9.59
(10 ft)	lb			*23630	17570	*14440	9570	*11220	6020	8250	3990		5400	2360	(31.5)
1.5 m	kg			*8900	6830	8180	3840	5160	2470	3590	1670		2420	1040	9.54
(5 ft)	lb			*19620	15060	18030	8470	11380	5450	7910	3680		5340	2290	(31.3)
Ground	kg			*10210	6570	7830	3550	4950	2290	3480	1570		2550	1100	9.21
Line	lb			*22510	14480	17260	7830	10910	5050	7670	3460		5620	2430	(30.2)
-1.5 m	kg	*9470	*9470	*13480	6590	7710	3450	4850	2200	3440	1530		2880	1290	8.56
(-5 ft)	lb	*20880	*20880	*29720	14530	17000	7610	10690	4850	7580	3370		6350	2840	(28.1)
-3.0 m	kg	*12940	*12940	*14070	6740	7760	3790	4870	2220				3630	1700	7.50
(-10 ft)	lb	*28530	*28530	*31020	14860	17110	7690	10740	4890				8000	3750	(24.6)
-4.5 m	kg			*11670	7050	7980	3670								
(-15 ft)	lb			*25730	15540	17590	8090								

1. Lifting capacity is based on SAE J1097, ISO 10567.

2. Lifting capacity of the Robex Series does not exceed 75% of the tipping load with the machine on firm, level ground or 87% of full hydraulic capacity.

3. The load point is a hook located on the back of the bucket.













4. (*) indicates the load limited by hydraulic capacity.

Lifting Capacity













R210W-9A

 Rating over-front  Rating over-side or 360 degree

Boom : 5.65 m (18' 6") / Arm : 2.92 m (9' 7") / Bucket : 0.80 m³ (1.05 yd³) SAE heaped / Front outrigger and rear dozer blade down

Load point height m (ft)	Load radius										At max. reach			
	1.5 m (5 ft)		3.0 m (10 ft)		4.5 m (15 ft)		6.0 m (20 ft)		7.5 m (25 ft)		Capacity		Reach	
													m (ft)	
9.0 m (30 ft)	kg											*3410	*3410	6.52
	lb											*7520	*7520	(21.4)
7.5 m (25 ft)	kg											*3470	3210	7.96
	lb											*7650	7080	(26.1)
6.0 m (20 ft)	kg								*2690	*2690		*3580	2580	8.85
	lb								*5930	*5930		*7890	5690	(29.0)
4.5 m (15 ft)	kg						*4210	*4210	*3980	3380		*3720	2250	9.37
	lb						*9280	*9280	*8770	7450		*8200	4960	(30.7)
3.0 m (10 ft)	kg		*10720	*10720	*6550	*6550	*5090	4750	*4410	3250		*3890	2090	9.59
	lb		*23630	*23630	*14440	*14440	*11220	10470	*9720	7170		*8580	4610	(31.5)
1.5 m (5 ft)	kg		*8900	*8900	*8350	7040	*6020	4460	*4900	3100		*4080	2070	9.54
	lb		*19620	*19620	*18410	15520	*13270	9830	*10800	6830		*8990	4560	(31.3)
Ground	kg		*10210	*10210	*9470	6700	*6730	4260	*5300	2990		*4290	2180	9.21
Line	lb		*22510	*22510	*20880	14770	*14840	9390	*11680	6590		*9460	4810	(30.2)
-1.5 m (-5 ft)	kg	*9470	*9470	*13480	*13480	*9820	6590	*7060	4160	*5440	2950	*4500	2470	8.56
	lb	*20880	*20880	*29720	*29720	*21650	14530	*15560	9170	*11990	6500	*9920	5450	(28.1)
-3.0 m (-10 ft)	kg	*12940	*12940	*14070	14020	*9430	6640	*6830	4190			*4640	3130	7.50
	lb	*28530	*28530	*31020	30910	*20790	14640	*15060	9240			*10230	6900	(24.6)
-4.5 m (-15 ft)	kg			*11670	*11670	*7990	6850							
	lb			*25730	*25730	*17610	15100							

Boom : 5.65 m (18' 6") / Arm : 2.92 m (9' 7") / Bucket : 0.80 m³ (1.05 yd³) SAE heaped / Front outrigger and rear dozer blade up

Load point height m (ft)	Load radius										At max. reach			
	1.5 m (5 ft)		3.0 m (10 ft)		4.5 m (15 ft)		6.0 m (20 ft)		7.5 m (25 ft)		Capacity		Reach	
													m (ft)	
9.0 m (30 ft)	kg											*3410	2840	6.52
	lb											*7520	6260	(21.4)
7.5 m (25 ft)	kg											*3470	1870	7.96
	lb											*7650	4120	(26.1)
6.0 m (20 ft)	kg								*2690	2010		2970	1420	8.85
	lb								*5930	4430		6550	3130	(29.0)
4.5 m (15 ft)	kg						*4210	2990	3880	1930		2610	1190	9.37
	lb						*9280	6590	8550	4250		5750	2620	(30.7)
3.0 m (10 ft)	kg		*10720	7970	*6550	4340	*5090	2730	3740	1810		2450	1070	9.59
	lb		*23630	17570	*14440	9570	*11220	6020	8250	3990		5400	2360	(31.5)
1.5 m (5 ft)	kg		*8900	6830	8180	3840	5160	2470	3590	1670		2420	1040	9.54
	lb		*19620	15060	18030	8470	11380	5450	7910	3680		5340	2290	(31.3)
Ground	kg		*10210	6570	7830	3550	4950	2290	3480	1570		2550	1100	9.21
Line	lb		*22510	14480	17260	7830	10910	5050	7670	3460		5620	2430	(30.2)
-1.5 m (-5 ft)	kg	*9470	*9470	*13480	6590	7710	3450	4850	2200	3440	1530	2880	1290	8.56
	lb	*20880	*20880	*29720	14530	17000	7610	10690	4850	7580	3370	6350	2840	(28.1)
-3.0 m (-10 ft)	kg	*12940	*12940	*14070	6740	7760	3490	4870	2220			3630	1700	7.50
	lb	*28530	*28530	*31020	14860	17110	7690	10740	4890			8000	3750	(24.6)
-4.5 m (-15 ft)	kg			*11670	7050	7980	3670							
	lb			*25730	15540	17590	8090							

1. Lifting capacity is based on SAE J1097, ISO 10567.

2. Lifting capacity of the Robex Series does not exceed 75% of the tipping load with the machine on firm, level ground or 87% of full hydraulic capacity.

3. The load point is a hook located on the back of the bucket.

4. (*) indicates the load limited by hydraulic capacity.