

Robex

330LC-9A

With Tier 4 Interim Engine installed

HYUNDAI HEAVY INDUSTRIES

MOVING YOU FURTHER



*Photo may include optional equipment.

 **HYUNDAI**
CONSTRUCTION EQUIPMENT AMERICAS, INC.

PRIDE AT WORK

Hyundai Heavy Industries strives to build state-of-the-art earthmoving equipment to give every operator maximum performance, more precision, versatile machine preferences, and proven quality.

Take pride in your work with Hyundai!



Robex 330LC-9A

Machine Walk-Around



*Photo may include optional equipment.

Engine Technology

Proven, reliable, fuel efficient, low emission and low noise
Cummins Tier 4 interim & EU stage III B engine

Hydraulic System Improvements

New patented hydraulic control for improved controllability / Improved control valve design for added efficiency and smoother operation / New auto boom and swing priority system for optimum speed / New auto power boost feature for additional power when needed / Improved arm-in and boom-down flow regeneration system for added speed and efficiency

Pump Compartment

Industry-leading, powerful, reliable Kawasaki designed, variable volume in-line axial piston pumps
New compact solenoid block equipped with 4 solenoid valves, 1 EPPR valve, 1 check valve accumulator and pilot filter - controls 2 speed travel, power boost, boom priority, safety lock, arm regeneration

Enhanced Operator Cab

Improved Visibility

Enlarged cab with improved visibility / See-through upper skylight for visibility and ventilation
Larger right-side glass, now one piece, for better right visibility
Safety glass windows on all sides - less expensive than (polycarbonate) and won't scratch or fade
Closeable sunshade for operator convenience / Reduced front window seam for improved operator view

Improved Cab Construction

New steel tube construction for added operator safety, protection and durability
New window open/close mechanism designed with cable and spring lift assist and single latch release

Improved Suspension Seat / Console Assembly

Ergonomic joysticks with auxiliary control buttons for attachment use with new sleek styling
Heated suspension (standard) or optional air ride suspension with heat
New joystick consoles - now adjustable in height by pushing a button
Integrated seat with consoles - reduces the operator fatigue

Advanced 7" Color Cluster with Touch Screen

New Color LCD Display with easy to read digital gauges for hydraulic oil temperature, water temperature, and fuel. Simplified design makes adjustment and diagnostics easier. Also, new enhanced features such as rear-view camera are integrated into monitor.

3 power modes : (P) Power, (S) Standard, (E) Economy, 2 work modes : Dig & Attachment, (U) User mode for operator preference

Enhanced self-diagnostic features with GPS download capability

One pump flow or two pump flow for optional attachment is now selectable through the cluster
New anti-theft system with password capability

Boom speed and arm regeneration are selectable through the monitor.

Auto power boost is now available - selectable (on/off) through the monitor.

Powerful air conditioning and heat with auto climate control

RMS (Remote Management System) works through GPS/satellite technology to ultimately provide better customer service and support.

Undercarriage

Sealed track chain (urethane seals) / Standard track rail guard / Comfortable bolt-on steps

Large upper roller cut-outs for debris clean-out / Tapered side frames for debris clean-out / Grease-type track tensioner

PRECISION

Innovative hydraulic system technologies make the 9A series excavator fast, smooth and easy to control.



*Photo may include optional equipment.

Computer Aided Power

The engine horsepower and hydraulic horsepower together in unison through the advanced CAPO (Computer Aided Power Optimization) system flow for the job at hand. Operator can set their own preferences for boom or swing priority, power mode selection and optional work tools at the touch of a button.

The CAPO system also provides complete self-diagnostic features and digital gauges for important information like hydraulic oil temperature, water temperatures and fuel level. This system interfaces with multiple sensors placed throughout the hydraulic system as well as the electronically controlled engine to provide the optimum level of engine power and hydraulic flow.

Power Mode

P (Power Max) mode maximizes machine speed and power for mass production.

S (Standard) mode provides a reduced, fixed rpm for optimum performance and improved fuel economy. For maximum fuel savings and improved control, E (Economy) mode provides precise flow and engine power based on load demand. Three unique power modes provide the operator with custom power, speed and fuel economy.

Work Mode

The work mode allows the operator to select single flow attachments like a hydraulic breaker or bi-directional flow attachments like a crusher. Flow settings unique to each attachment can be programmed from within the cluster.

User Mode

Some jobs require more precise machine settings. Using the versatile U (User) mode, the operator can customize engine speed, pump output, idle speed and other machine settings for the job at hand.

Improved Hydraulic System



To achieve optimum precision, Hyundai redesigned the hydraulic system to provide the operator with super fine touch and improved controllability. Improved pump flow control reduces flow when controls are not being used to minimize fuel consumption.

Improved spool valves in the control valve are engineered to provide more precise flow to each function with less effort.

Improved hydraulic valves, precision-designed variable volume piston pumps, fine-touch pilot controls, and enhanced travel functions make any operator running a 9A series look like a smooth operator.

Newly improved features include arm-in and boom-down flow regeneration, improved control valve technology and innovative auto boom and swing priority for optimal performance in any application.



Auto Boom-swing Priority

This smart function automatically and continuously looks the ideal hydraulic flow balance for the boom and swing motions of the machine. The advanced CAPO system monitors the hydraulic system and adjusts its settings to maximize performance and productivity.

PERFORMANCE

9A series is designed for maximum performance to keep the operator working productively.



*Photo may include optional equipment.

Track Rail Guard & Adjusters

Durable track rail guards keep track links in place. Track adjustment is made easy with standard grease cylinder track adjusters and shock absorbing springs.

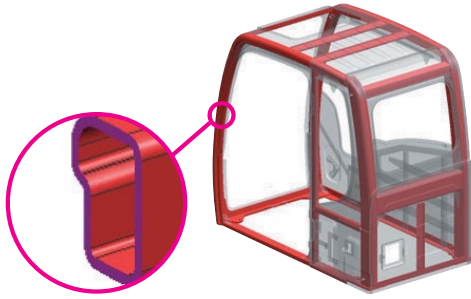
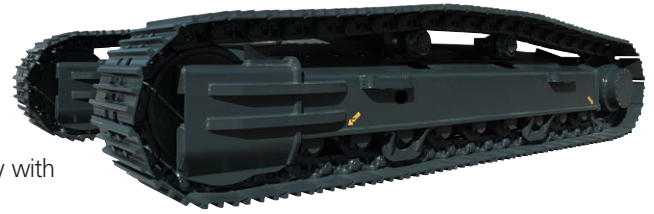

Structure Strength

The 9A series cabin structure has been fitted with stronger but slimmer tubing for more safety and improved visibility. Low-stress, high strength steel is integrally welded to form a stronger, more durable upper and lower frame. Structural integrity was tested by way of FEM (Finite Elements Method) analysis and long-term durability tests. The optional ROPS (Roll Over Protective Structure) cab can be equipped to enhance operator safety.

Cummins QSL9 Engine

Built on a heritage of reliability and durability, Cummins QSL9 for Tier 4 Interim/Stage IIIB regulations takes a major step forward with the introduction of an Xtra-High Pressure Injection (XPI) fuel system. This heavy-duty system delivers a constant stream of pressurized fuel across all engine rpm speeds, providing cleaner combustion and improved engine response with multiple injections every combustion cycle. The fuel system is complemented by Cummins VGT Turbocharger, which continuously varies the airflow to precisely match engine rpm and load demands for optimal performance. Each component and system is carefully matched and managed through a more robust Electronic Control Module (ECM) and the Cummins Particulate Filter. The total integration and optimization of all elements working together results in better performance, lower maintenance and better fuel economy than the previous model. The QSL9 for Tier 4 Interim/Stage IIIB is designed to provide the lowest cost of operation in its class, delivering superior lifetime value.

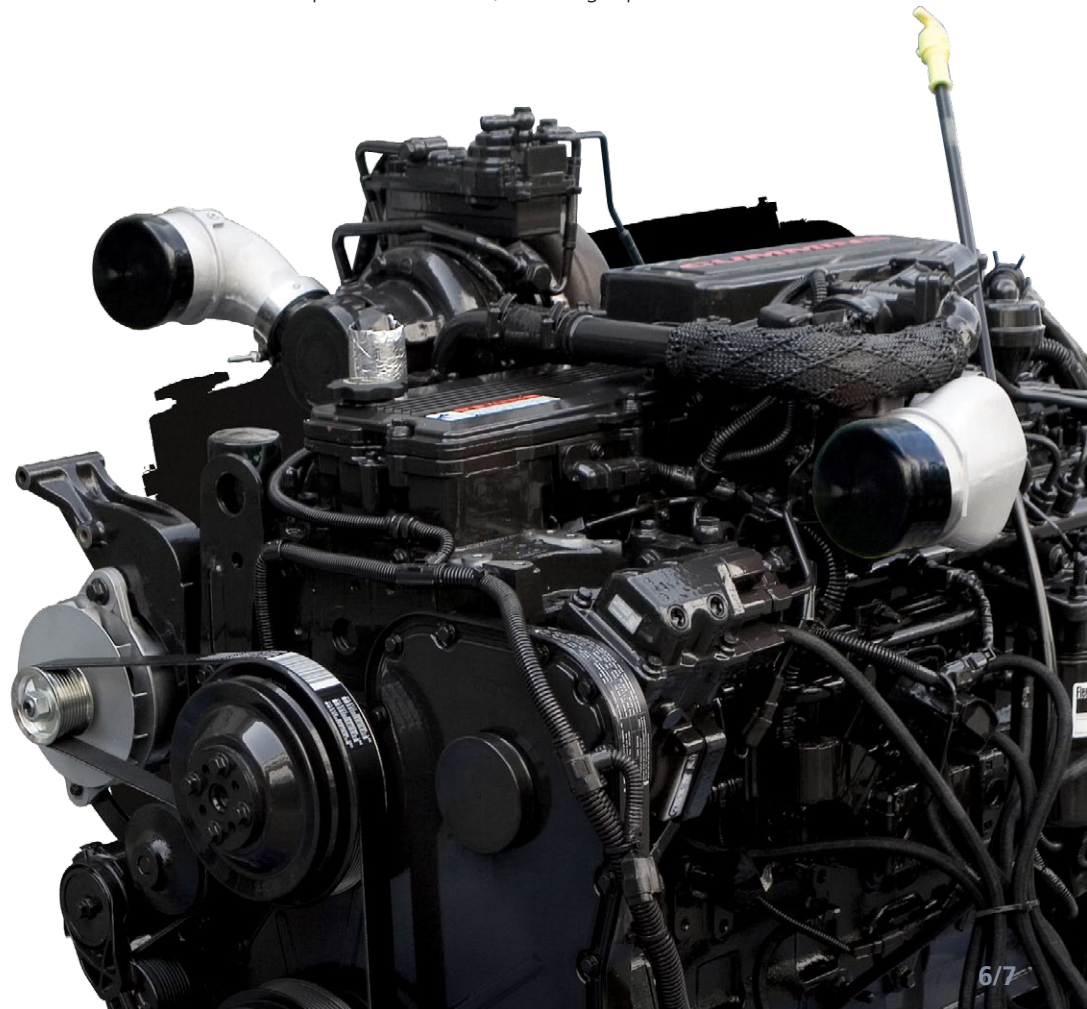

PREFERENCE

Operating a 9A series is unique to every operator. Operators can fully customize their work environment and operating preferences to fit their individual needs.



*Photo may include optional equipment.



Wide Cabin with Excellent Visibility

The newly designed cabin has more space, a wider field of view and operator comfort. Special attention was given to a clear, open and convenient interior with plenty of visibility of the machine surroundings and the job at hand. This well-balanced combination of comfort and visibility puts the operator in the perfect position to work safely and securely.

In 9A series cabin you can easily adjust the seat, console and armrest settings to best suit your comfort level. The seat is integrated with console and absorbs console vibration with the seat suspension to reduce operator's fatigue. New joystick consoles are adjustable in height by pushing a button. Other preference settings that add to overall operator comfort include the fully automatic high capacity airconditioning system, transparent polycarbonate glass sun roof, large and easy to control sun visor, and the radio / USB player.

Operator Comfort



Reduced Stress

Work is stressful enough. Your work environment should be stress free. Hyundai's 9A series provides improved cab amenities, additional space and a comfortable seat to minimize stress to the operator. A powerful climate control system provides the operator with optimum air temperature. An advanced audio system with USB player, AM/FM stereo and MP3 capabilities, plus remotely located controls, is perfect for listening to your favorite music.

Operators can talk on the phone with the hands-free cell phone feature. Also, the newly designed optional remote control offers mobile hands-free bluetooth and hands-free radio cable function.



Smart Key System (Option)

9A series excavators provide smart key system as an option. This allows the operator to start the engine by the push of a starter button without inserting a key in the ignition.

Operator - Friendly Cluster

The advanced new cluster with 7-inch wide color LCD touch screen and toggle switches allows the operator to select his personal machine preferences. Power and work mode selection, self diagnostics, optional rear-view camera, maintenance check lists, start-up machine security, and video functions were integrated into the cluster to make the machine more versatile and the operator more productive.

The newly applied FM transmitter application transmits signal to USB & radio player with the same frequency as the cluster. The player outputs the audio through the internal speaker in the cab. An adjustable cluster hinge bracket improves cluster visibility, and video & firmware updates are easy with the USB host support.



Monitor Tilt Range



Horizontal
Total : 15°



Vertical
Total : 30°



PROFITABILITY

9A series is designed to maximize profitability through improved efficiencies, enhanced service features and longer life components.



*Photo may include optional equipment.

Fuel Efficiency

9A series excavators are engineered to be extremely fuel efficient. New innovations like the variable speed fan clutch, two-stage auto decel system and the new economy mode help to conserve fuel and reduce the impact on the environment.



Hi-mate (Remote Management System)

Hi-mate, Hyundai's proprietary remote management system, provides operators and dealer service personnel access to vital service and diagnostic information on the machine from any computer with internet access. Users can pinpoint machine location using digital mapping and set machine work boundaries, reducing the need for multiple service calls. Hi-mate saves time and money for the owner and dealer by promoting preventative maintenance and reducing machine downtime.

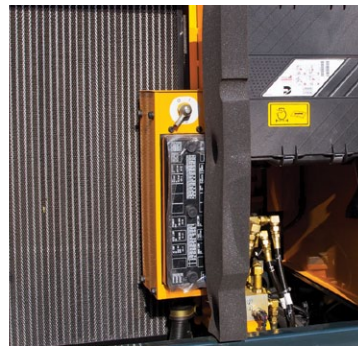

Easy Access

Ground-line access to filters, lube fittings, fuses, machine computer components and wide open compartments makes service more convenient on the 9A series.



Long-Life Components

9A series excavators were designed with bushings with long-life lube intervals (250 hrs), polymer shims (wear resistant, noise reducing), long-life hydraulic filters (1,000hrs), long-life hydraulic oil (5,000hrs), more efficient cooling systems and integrated preheating systems which extend service intervals, minimize operating costs and reduce machine down time.

Specifications

ENGINE

MODEL	Cummins QSL9		
Type	Water-cooled, 4-cycle Diesel, 6-cylinder in-line, Direct injection, Turbocharged, Charge air cooled, Low emission		
Rated flywheel horse power	SAE	J1995 (gross)	282 HP (210 kW)/ 1,750 rpm
		J1349 (net)	268 HP (200 kW)/ 1,750 rpm
	DIN	6271/1 (gross)	286 PS (210 kW)/ 1,750 rpm
		6271/1 (net)	272 PS (200 kW)/ 1,750 rpm
Max. torque	123.7 kgf-m (895 lbf-ft)/ 1,500 rpm		
Bore X stroke	114 x 145 mm (4.5" x 5.7")		
Piston displacement	8,900 cc (543 in ³)		
Batteries	2 x 12 V x 160 AH		
Starting motor	24 V, 7.8kW		
Alternator	24 V, 95 Amp		

HYDRAULIC SYSTEM

MAIN PUMP	
Type	Variable displacement tandem-axial piston pumps
Max. flow	2 X 270 L/min (71.3 US gpm / 59.4 UK gpm)
Sub-pump for pilot circuit	Gear pump

Cross-sensing and fuel saving pump system

HYDRAULIC MOTORS	
Travel	Two-speed axial pistons motor with brake valve and parking brake
Swing	Axial piston motor with automatic brake

RELIEF VALVE SETTING	
Implement circuits	350 kgf/cm ² (4,978 psi)
Travel	350 kgf/cm ² (4,978 psi)
Power boost (boom, arm, bucket)	380 kgf/cm ² (5,404 psi)
Swing circuit	300 kgf/cm ² (4,267 psi)
Pilot circuit	40 kgf/cm ² (568 psi)
Service valve	Installed

HYDRAULIC CYLINDERS	
No. of cylinder bore X stroke	Boom: 2-150 X 1,480 mm (5.9" X 58.3")
	Arm: 1-160 X 1,685 mm (6.3" X 66.3")
	Bucket: 1-140 X 1,285 mm (5.5" X 50.6")

DRIVES & BRAKES

Drive method	Fully hydrostatic type
Drive motor	Axial piston motor, in-shoe design
Reduction system	Planetary reduction gear
Max. drawbar pull	29,500 kgf (65,040 lbf)
Max. travel speed (high / low)	5.5 km/hr (3.4 mph) / 3.3 km/hr (2.1 mph)
Gradeability	35° (70 %)
Parking brake	Multi wet disc

CONTROL

Pilot pressure operated joysticks and pedals with detachable lever provide almost effortless and fatigueless operation.

Pilot control	Two joysticks with one safety lever (LH): Swing and arm, (RH): Boom and bucket (ISO)
Traveling and steering	Two levers with pedals
Engine throttle	Electric, Dial type

SWING SYSTEM

Swing motor	Fixed displacement axial pistons motor
Swing reduction	Planetary gear reduction
Swing bearing lubrication	Grease-bathed
Swing brake	Multi wet disc
Swing speed	9.4 rpm

COOLANT & LUBRICANT CAPACITY

	liter	US gal	UK gal
Re-filling			
Fuel tank	500	132.1	110.0
Engine coolant	55	14.5	12.1
Engine oil	30	7.9	6.6
Swing device	11	1.6	1.3
Final drive (each)	5.5	2.1	1.8
Hydraulic system (including tank)	330	87.2	72.6
Hydraulic tank	190	50.2	41.8

UNDERCARRIAGE

The X-leg type center frame is integrally welded with reinforced box-section track frames. The undercarriage includes lubricated rollers, idlers, track adjusters with shock absorbing springs and sprockets, and a track chain with double or triple grouser shoes.

Center frame	X - leg type
Track frame	Pentagonal box type
No. of shoes on each side	48
No. of carrier rollers on each side	2
No. of track rollers on each side	9
No. of rail guards on each side	2

OPERATING WEIGHT (APPROXIMATE)

Operating weight, including 6,450mm (21' 2") boom, 3,200mm (10' 6") arm, SAE heaped 1.44m³ (1.88 yd³) bucket, lubricant, coolant, full fuel tank, full hydraulic tank, and all standard equipments.

MAJOR COMPONENT WEIGHT	
Upperstructure	8,120 kg (17,900 lb)
Boom (with arm cylinder)	3,030 kg (6,680 lb)
Arm (with bucket cylinder)	1,770 kg (3,900 lb)

OPERATING WEIGHT				
Shoes		Operating weight		Ground pressure
Type	Width mm (in)	kg (lb)		kgf/cm ² (psi)
Triple grouser	600 mm (24")	R330LC-9A	33,000 (72,750)	0.63 (8.96)
		R300NLC-9A	32,800 (72,310)	0.63 (8.96)
		R330LC-9A H/W	35,500 (78,260)	0.68 (9.67)
	700 mm (28")	R330LC-9A	33,600 (74,070)	0.55 (7.83)
		R330LC-9A H/W	36,100 (79,590)	0.59 (8.39)
		R330LC-9A	34,000 (74,960)	0.49 (6.57)
800 mm (32")	R330LC-9A H/W	36,500 (80,470)	0.50 (7.14)	
	900 mm (36")	R330LC-9A	34,400 (75,840)	0.44 (6.26)
Double grouser	700 mm (28")	R330LC-9A H/W	37,010 (81,590)	0.60 (8.53)

BUCKETS

All buckets are welded with high-strength steel.

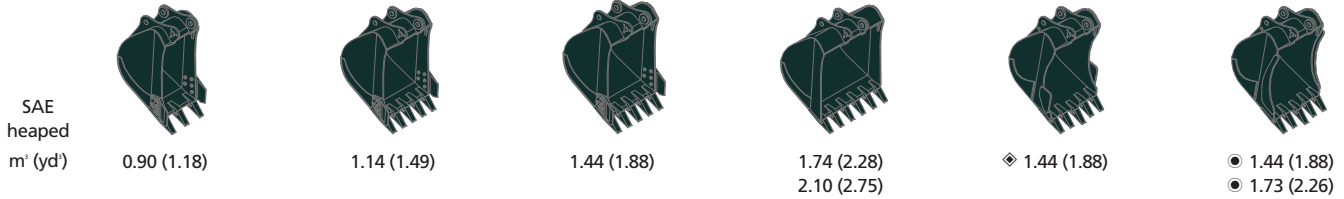

Capacity m³ (yd³)		Width mm (in)		Weight kg (lb)	Recommendation mm (ft-in)				
SAE heaped	CECE heaped	Without side cutters	With side cutters		6,450 (21' 2") Boom				6,150 (20' 2") Boom
					2,200 (7' 3") Arm	2,500 (8' 2") Arm	3,200 (10' 6") Arm	4,050 (13' 3") Arm	
0.90 (1.18)	0.80 (1.05)	950 (37.4)	1,070 (42.1)	870 (1,920)	●	●	●	●	●
1.14 (1.49)	1.00 (1.31)	1,110 (43.7)	1,230 (48.4)	980 (2,160)	●	●	●	●	●
1.44 (1.88)	1.25 (1.63)	1,380 (54.3)	1,500 (59.1)	1,110 (2,450)	●	●	●	■	●
1.74 (2.28)	1.50 (1.96)	1,620 (63.8)	1,740 (68.5)	1,230 (2,710)	●	●	■	▲	●
2.10 (2.75)	1.80 (2.35)	1,910 (75.2)	2,030 (79.9)	1,370 (3,020)	■	■	▲	-	■
◆ 1.44 (1.88)	1.25 (1.63)	1,470 (57.9)	-	1,380 (3,040)	●	●	■	▲	●
● 1.44 (1.88)	1.25 (1.63)	1,470 (57.9)	-	1,470 (3,240)	●	●	■	▲	●
● 1.73 (2.26)	1.50 (1.96)	1,710 (67.3)	-	1,610 (3,550)	■	■	▲	-	●

◆ Heavy duty bucket

● Rock-Heavy duty bucket

●: Applicable for materials with density of 2,000 kg /m³ (3,370 lb/ yd³) or less

■: Applicable for materials with density of 1,600 kg /m³ (2,700 lb/ yd³) or less

▲: Applicable for materials with density of 1,100 kg /m³ (1,850 lb/ yd³) or less

ATTACHMENT

Booms and arms are welded with a low-stress, full-box section design. 6.15m(20' 2"), 6.45m(21' 2") Booms and 2.2m(7' 3"), 2.5m(8' 2"), 3.2m(10' 6"), 4.05m(13' 3")

Arms are available.

DIGGING FORCE

Boom	Length	mm (ft-in)	6,450 (21' 2")				Remarks
	Weight	kg (lb)	3,030 (6,680)				
Arm	Length	mm (ft-in)	2,200 (7' 3")	2,500 (8' 2")	3,200 (10' 6")	4,050 (13' 3")	Power Boost
	Weight	kg (lb)	1,560 (3,440)	1,650 (3,640)	1,770 (3,900)	1,870 (4,120)	
Bucket digging force	SAE	kN	189.3 [205.5]	189.3 [205.5]	189.3 [205.5]	189.3 [205.5]	[]: Power Boost
		kgf	19,300 [20,950]	19,300 [20,950]	19,300 [20,950]	19,300 [20,950]	
		lbf	42,550 [46,200]	42,550 [46,200]	42,550 [46,200]	42,550 [46,200]	
	ISO	kN	211.8 [230.0]	211.8 [230.0]	211.8 [230.0]	211.8 [230.0]	
		kgf	21,600 [23,450]	21,600 [23,450]	21,600 [23,450]	21,600 [23,450]	
		lbf	47,620 [51,700]	47,620 [51,700]	47,620 [51,700]	47,620 [51,700]	
Arm crowd force	SAE	kN	196.6 [213.4]	178.9 [194.2]	143.2 [155.5]	119.6 [129.9]	
		kgf	20,000 [21,760]	18,200 [19,810]	14,600 [15,850]	12,200 [13,240]	
		lbf	44,190 [47,980]	40,220 [43,670]	32,190 [34,950]	26,890 [29,190]	
	ISO	kN	202.8 [220.2]	185.1 [201.0]	147.1 [159.7]	122.7 [133.3]	
		kgf	20,700 [22,450]	18,900 [20,500]	15,000 [16,290]	12,515 [13,590]	
		lbf	45,600 [49,510]	41,620 [45,190]	33,070 [35,900]	27,590 [29,950]	

Note: Boom weight includes arm cylinder, piping, and pin

Arm weight includes bucket cylinder, linkage, and pin

Dimensions & Working Range

R330LC-9A / R330NLC-9A DIMENSIONS

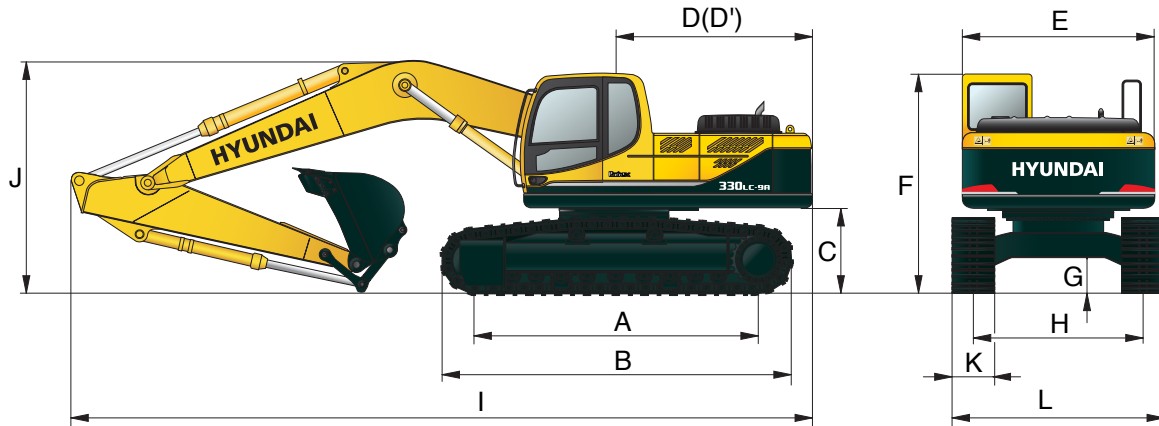

Unit : mm (ft . in)

A	Tumbler distance	R330LC-9A	4,030 (13' 3")					
		R330NLC-9A	4,030 (13' 3")					
B	Overall length of crawler		4,940 (16' 2")					
C	Ground clearance of counterweight		1,200 (3' 11")					
D	Tail swing radius		3,560 (11' 8")					
D'	Rear-end length		3,504 (11' 6")					
E	Overall width of upperstructure		2,980 (9' 9")					
F	Overall height of cab		3,130 (10' 3")					
G	Min. ground clearance		500 (1' 8")					
H	Track gauge	R330LC-9A	2,680 (8' 10")					
		R300NLC-9A	2,390 (7' 10")					
	Boom length			6,450 (21' 2")				6,150 (20' 2")
	Arm length		2,200 (7' 3")	2,500 (8' 2")	3,200 (10' 6")	4,050 (13' 3")	2,200 (7' 3")	
I	Overall length		11,470 (37' 8")	11,340 (37' 2")	11,220 (36' 10")	11,220 (36' 10")	11,170 (36' 8")	
J	Overall height of boom		3,640 (11' 11")	3,670 (12' 0")	3,380 (11' 1")	3,860 (12' 8")	3,680 (12' 1")	
K	Track shoe width		600 (24")	700 (28")	800 (32")	900 (36")		
L	Overall width	R330LC-9A	3,200 (10' 6")	3,300 (10' 10")	3,400 (11' 2")	3,500 (11' 16")		
		R300NLC-9A	2,990 (9' 10")	-	-	-		

R330LC-9A / R330NLC-9A WORKING RANGE

Unit : mm (ft . in)

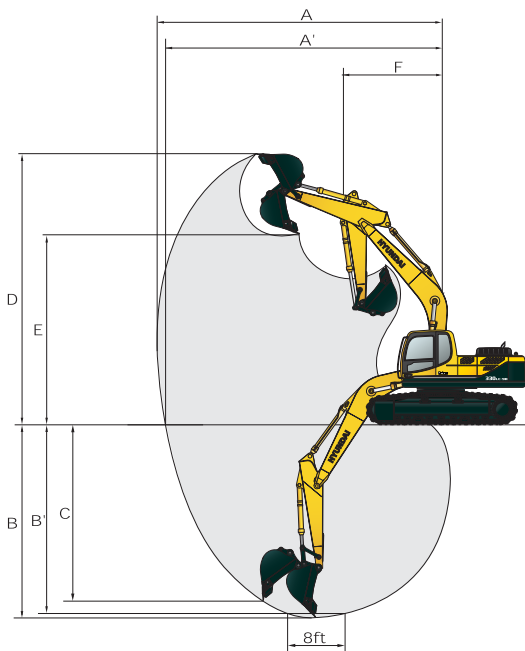

	Boom length		6,450 (21' 2")				6,150 (20' 2")
	Arm length		2,200 (7' 3")	2,500 (8' 2")	3,200 (10' 6")	4,050 (13' 3")	2,200 (7' 3")
A	Max. digging reach		10,330 (33' 11")	10,550 (34' 7")	11,140 (36' 7")	11,950 (39' 2")	10,020 (32' 10")
A'	Max. digging reach on ground		10,110 (33' 2")	10,330 (33' 11")	10,940 (35' 11")	11,760 (38' 7")	9,800 (32' 2")
B	Max. digging depth		6,370 (20' 11")	6,670 (21' 11")	7,370 (24' 2")	8,220 (26' 12")	6,160 (20' 3")
B'	Max. digging depth (8' level)		6,160 (20' 3")	6,470 (21' 3")	7,210 (23' 8")	8,080 (26' 6")	5,950 (19' 6")
C	Max. vertical wall digging depth		5,980 (19' 7")	5,920 (19' 5")	6,360 (20' 10")	7,260 (23' 10")	5,710 (18' 9")
D	Max. digging height		10,220 (33' 6")	10,170 (33' 4")	10,310 (33' 10")	10,710 (35' 2")	9,940 (32' 7")
E	Max. dumping height		7,050 (23' 2")	7,050 (23' 2")	7,240 (23' 9")	7,630 (25' 0")	6,780 (22' 3")
F	Min. swing radius		4,700 (15' 5")	4,500 (14' 9")	4,470 (14' 8")	4,470 (14' 8")	4,520 (14' 10")

Dimensions & Working Range

R330LC-9A HIGH WALKER DIMENSIONS

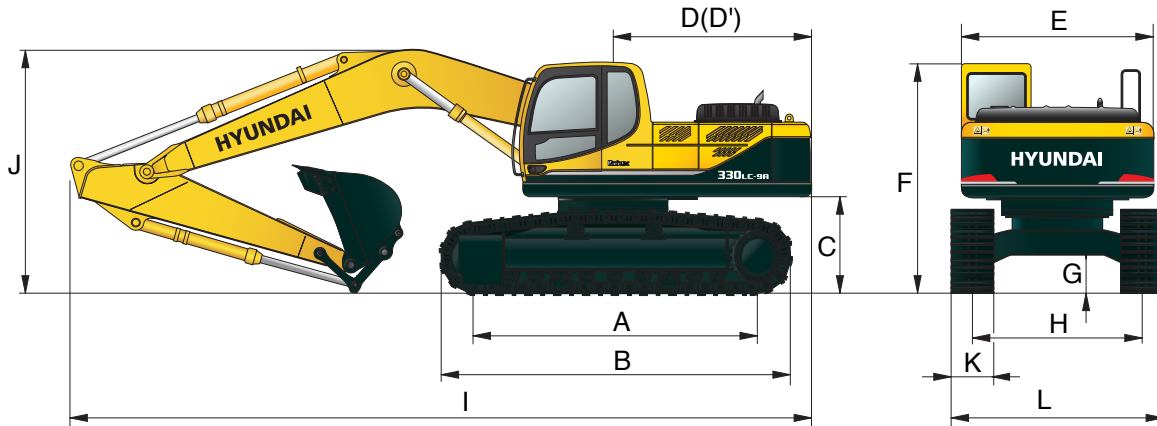

Unit : mm (ft · in)

A Tumbler distance	4,030 (13' 3")	Boom length	6,450 (21' 2")			6,150 (20' 2")
B Overall length of crawler	4,940 (16' 2")	Arm length	2,200 (7' 3")	2,500 (8' 2")	3,200 (10' 6")	4,050 (13' 3")
C Ground clearance of counterweight	1,500 (4' 11")	I Overall length	11,460 (37' 7")	11,340 (37' 2")	11,150 (36' 7")	11,240 (36' 11")
D Tail swing radius	3,560 (11' 8")	J Overall height of boom	3,740 (12' 3")	3,760 (12' 4")	3,360 (11' 0")	3,810 (12' 6")
D' Rear-end length	3,504 (11' 6")	K Track shoe width	Type		Double grouser	
E Overall width of upperstructure	2,980 (9' 9")		Width		700 (28")	
F Overall height of cab	3,390 (11' 1")	L Overall width	600 (24")	700 (28")	800 (32")	700 (28")
G Min. ground clearance	765 (2' 6")		3,470 (11' 5")	3,570 (11' 9")	3,670 (12' 0")	3,570 (11' 9")
H Track gauge	2,870 (9' 5")					

R330LC-9A HIGH WALKER WORKING RANGE

Unit : mm (ft · in)

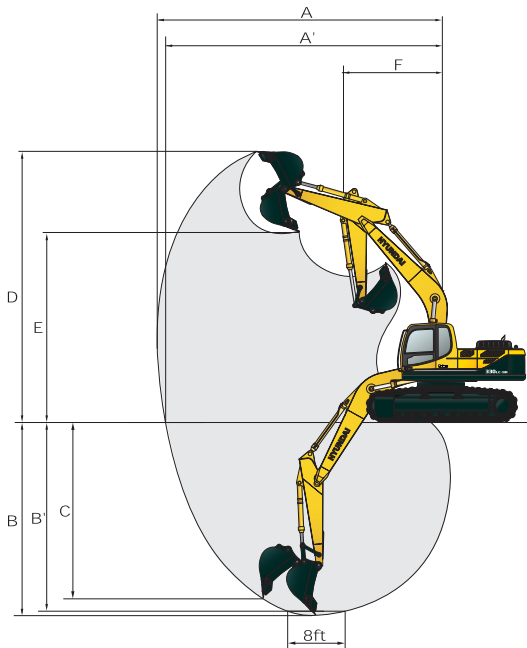











Boom length	6,450 (21' 2")				6,150 (20' 2")
Arm length	2,200 (7' 3")	2,500 (8' 2")	3,200 (10' 6")	4,050 (13' 3")	2,200 (7' 3")
A Max. digging reach	10,330 (33' 11")	10,550 (34' 7")	11,140 (36' 7")	11,950 (39' 2")	10,020 (32' 10")
A' Max. digging reach on ground	10,040 (32' 11")	10,270 (33' 8")	10,880 (35' 8")	11,710 (38' 5")	9,730 (31' 11")
B Max. digging depth	6,100 (20' 0")	6,400 (20' 12")	7,100 (23' 4")	7,950 (26' 1")	5,880 (19' 3")
B' Max. digging depth (8' level)	5,890 (19' 4")	6,200 (20' 4")	6,940 (22' 9")	7,950 (26' 1")	5,680 (18' 8")
C Max. vertical wall digging depth	5,700 (18' 8")	5,650 (18' 6")	6,080 (19' 11")	6,980 (22' 11")	5,440 (17' 10")
D Max. digging height	10,500 (34' 5")	10,450 (34' 3")	10,590 (34' 9")	10,990 (36' 1")	10,220 (33' 6")
E Max. dumping height	7,330 (24' 1")	10,450 (34' 3")	7,520 (24' 8")	7,910 (25' 11")	7,060 (23' 2")
F Min. swing radius	4,700 (15' 5")	4,500 (14' 9")	4,470 (14' 8")	4,470 (14' 8")	4,520 (14' 10")

Lifting Capacity











R330LC-9A

 Rating over-front  Rating over-side or 360 degree













Boom : 6.45m (21' 2") / Arm : 2.2 m (7' 3") / Bucket : 1.44 m³ (1.88 yd³) SAE heaped / Shoe : 600mm (24") triple grouser

Load point height m(ft)		Load radius								At max. reach		
		3.0 m (10 ft)		4.5 m (15 ft)		6.0 m (20 ft)		7.5 m (25 ft)		Capacity		Reach m (ft)
												
7.5 m (25 ft)	kg									*7120	5470	8.07
	lb									*15700	12060	(26.5)
6.0 m (20 ft)	kg					*8220	*8220	*7700	6100	6850	4420	8.95
	lb					*18120	*18120	*16980	13450	15100	9740	(29.4)
4.5 m (15 ft)	kg			*12360	*12360	*9550	8590	*8250	5910	6100	3890	9.47
	lb			*27250	*27250	*21050	18940	*18190	13030	13450	8580	(31.1)
3.0 m (10 ft)	kg					*11160	8050	8860	5660	5770	3630	9.70
	lb					*24600	17750	19530	12480	12720	8000	(31.8)
1.5 m (5 ft)	kg					12300	7610	8600	5420	5740	3600	9.66
	lb					27120	16780	18960	11950	12650	7940	(31.7)
Ground	kg			*18470	11470	12020	7370	8430	5260	6030	3780	9.34
	lb			*40720	25290	26500	16250	18580	11600	13290	8330	(30.6)
-1.5 m (-5 ft)	kg	*14420	*14420	*17890	11520	11960	7310	8380	5220	6770	4270	8.72
	lb	*31790	*31790	*39440	25400	26370	16120	18470	11510	14930	9410	(28.6)
-3.0 m (-10 ft)	kg	*22130	*22130	*16390	11720	12070	7410			*7930	5330	7.70
	lb	*48790	*48790	*36130	25840	26610	16340			*17480	11750	(25.3)
-4.5 m (-15 ft)	kg	*17840	*17840	*13400	12130							
	lb	*39330	*39330	*29540	26740							

Boom : 6.45m (21' 2") / Arm : 2.5 m (8' 2") / Bucket : 1.44 m³ (1.88 yd³) SAE heaped / Shoe : 600mm (24") triple grouser

Load point height m (ft)		Load radius								At max. reach				
		3.0 m (10 ft)		4.5 m (15 ft)		6.0 m (20 ft)		7.5 m (25 ft)		9.0 m (30 ft)		Capacity		Reach m (ft)
														
7.5 m (25 ft)	kg											*6720	5180	8.34
	lb											*14820	11420	(27.4)
6.0 m (20 ft)	kg							*7320	6140			6560	4220	9.19
	lb							*16140	13540			14460	9300	(30.2)
4.5 m (15 ft)	kg			*11600	*11600	*9120	8640	*7930	5930			5860	3720	9.70
	lb			*25570	*25570	*20110	19050	*17480	13070			12920	8200	(31.8)
3.0 m (10 ft)	kg			*15130	12530	*10770	8070	*8770	5650			5540	3470	9.92
	lb			*33360	27620	*23740	17790	*19330	12460			12210	7650	(32.5)
1.5 m (5 ft)	kg			*17590	11670	*12210	7600	8570	5390	6370	3990	5500	3430	9.88
	lb			*38780	25730	*26920	16760	18890	11880	14040	8800	12130	7560	(32.4)
Ground	kg			*18360	11380	11970	7310	8380	5210			5760	3590	9.57
	lb			*40480	25090	26390	16120	18470	11490			12700	7910	(31.4)
-1.5 m (-5 ft)	kg	*15010	*15010	*18010	11370	11860	7220	8300	5150			6410	4020	8.97
	lb	*33090	*33090	*39710	25070	26150	15920	18300	11350			14130	8860	(29.4)
-3.0 m (-10 ft)	kg	*22800	*22800	*16720	11550	11950	7300					7830	4950	7.98
	lb	*50270	*50270	*36860	25460	26350	16090					17260	10910	(26.2)
-4.5 m (-15 ft)	kg	*19110	*19110	*14080	11930	*10340	7590					*7300	7270	6.42
	lb	*42130	*42130	*31040	26300	*22800	16730					*16090	16030	(21.1)

Boom : 6.45m (21' 2") / Arm : 3.2 m (10' 6") / Bucket : 1.44 m³ (1.88 yd³) SAE heaped / Shoe : 600mm (24") triple grouser

Load point height m (ft)		Load radius										At max. reach				
		1.5 m (5 ft)		3.0 m (10 ft)		4.5 m (15 ft)		6.0 m (20 ft)		7.5 m (25 ft)		9.0 m (30 ft)		Capacity		Reach m (ft)
																
7.5 m (25 ft)	kg								*5240	*5240				*5970	4490	9.06
	lb								*11550	*11550				*13160	9900	(29.7)
6.0 m (20 ft)	kg								*6500	6260				5850	3730	9.84
	lb								*14330	13800				12900	8220	(32.3)
4.5 m (15 ft)	kg							*8090	*8090	*7190	6000	*5440	4280	5270	3310	10.31
	lb							*17840	*17840	*15850	13230	*11990	9440	11620	7300	(33.8)
3.0 m (10 ft)	kg					*13400	12930	*9820	8190	*8110	5690	6520	4120	4990	3090	10.52
	lb					*29540	28510	*21650	18060	*17880	12540	14370	9080	11000	6810	(34.5)
1.5 m (5 ft)	kg					*16400	11850	*11460	7640	8570	5380	6350	3960	4950	3040	10.48
	lb					*36160	26120	*25260	16840	18890	11860	14000	8730	10910	6700	(34.4)
Ground	kg			*10240	*10240	*17910	11320	11930	7270	8320	5150	6210	3830	5130	3150	10.19
	lb			*22580	*22580	*39480	24960	26300	16030	18340	11350	13690	8440	11310	6940	(33.4)
-1.5 m (-5 ft)	kg	*11380	*11380	*14470	*14470	*18150	11170	11730	7090	8180	5030			5620	3470	9.63
	lb	*25090	*25090	*31900	*31900	*40010	24630	25860	15630	18030	11090			12390	7650	(31.6)
-3.0 m (-10 ft)	kg	*15350	*15350	*19470	*19470	*17370	11250	11730	7090	8190	5040			6640	4140	8.74
	lb	*33840	*33840	*42920	*42920	*38290	24800	25860	15630	18060	11110			14640	9130	(28.7)
-4.5 m (-15 ft)	kg			*21820	*21820	*15410	11530	*11430	7270					*7480	5630	7.37
	lb			*48100	*48100	*33970	25420	*25200	16030					*16490	12410	(24.2)
-6.0 m (-20 ft)	kg					*11340	*11340									
	lb					*25000	*25000									

1. Lifting capacity is based on SAE J1097, ISO 10567.

2. Lifting capacity of the Robex Series does not exceed 75% of the tipping load with the machine on firm, level ground or 87% of full hydraulic capacity.

3. The load point is a hook located on the back of the bucket.

4. (*) indicates the load limited by hydraulic capacity.

Lifting Capacity

R330LC-9A

Rating over-front Rating over-side or 360 degree

Boom : 6.45m (21' 2") / Arm : 4.05 m (13' 3") / Bucket : 1.44 m³ (1.88 yd³) SAE heaped / Shoe : 600mm (24") triple grouser

Load point height m (ft)		Load radius										At max. reach				
		1.5 m (5 ft)		3.0 m (10 ft)		4.5 m (15 ft)		6.0 m (20 ft)		7.5 m (25 ft)		9.0 m (30 ft)		Capacity		Reach
																m (ft)
7.5 m	kg													*5250	3750	10.00
(25 ft)	lb													*11570	8270	(32.8)
6.0 m	kg										*4530	4510	5050	3180	10.71	
(20 ft)	lb										*9990	9940	11130	7010	(35.1)	
4.5 m	kg								*6270	6160	*5750	4370	4610	2850	11.13	
(15 ft)	lb								*13820	13580	*12680	9630	10160	6280	(36.5)	
3.0 m	kg			*18220	*18220	*11250	*11250	*8610	8460	*7280	5810	*6530	4180	4380	2670	11.32
(10 ft)	lb			*40170	*40170	*24800	*24800	*18980	18650	*16050	12810	*14400	9220	9660	5890	(37.1)
1.5 m	kg			*10440	*10440	*14750	12310	*10470	7840	*8360	5460	6380	3980	4330	2620	11.29
(5 ft)	lb			*23020	*23020	*32520	27140	*23080	17280	*18430	12040	14070	8770	9550	5780	(37.0)
Ground	kg			*10810	*10810	*17060	11520	*11950	7360	8350	5180	6200	3810	4460	2690	11.03
Line	lb			*23830	*23830	*37610	25400	*26350	16230	18410	11420	13670	8400	9830	5930	(36.2)
-1.5 m	kg	*9850	*9850	*13390	*13390	*18030	11170	11730	7080	8150	4990	6080	3710	4810	2920	10.52
(-5 ft)	lb	*21720	*21720	*29520	*29520	*39750	24630	25860	15610	17970	11000	13400	8180	10600	6440	(34.5)
-3.0 m	kg	*13020	*13020	*16980	*16980	*17900	11100	11620	6990	8070	4920	6070	3700	5510	3380	9.72
(-10 ft)	lb	*28700	*28700	*37430	*37430	*39460	24470	25620	15410	17790	10850	13380	8160	12150	7450	(31.9)
-4.5 m	kg	*16670	*16670	*21800	*21800	*16680	11260	11700	7060	8150	5000			6910	4310	8.53
(-15 ft)	lb	*36750	*36750	*48060	*48060	*36770	24820	25790	15560	17970	11020			15230	9500	(28.0)
-6.0 m	kg			*20030	*20030	*13950	11640	*10120	7340					*6790	6610	6.71
(-20 ft)	lb			*44160	*44160	*30750	25660	*22310	16180					*14970	14570	(22.0)

R330NLC-9A

Rating over-front Rating over-side or 360 degree

Boom : 6.45m (21' 2") / Arm : 2.2 m (7' 3") / Bucket : 1.44 m³ (1.88 yd³) SAE heaped / Shoe : 600mm (24") triple grouser

Load point height m (ft)		Load radius						At max. reach				
		3.0 m (10 ft)		4.5 m (15 ft)		6.0 m (20 ft)		7.5 m (25 ft)		Capacity		Reach
												m (ft)
7.5 m	kg									*7120	4630	8.07
(25 ft)	lb									*15700	10210	(26.5)
6.0 m	kg					*8220	7700	*7700	5160	6810	3700	8.95
(20 ft)	lb					*18120	16980	*16980	11380	15010	8160	(29.4)
4.5 m	kg			*12360	11430	*9550	7260	*8250	4980	6060	3220	9.47
(15 ft)	lb			*27250	25200	*21050	16010	*18190	10980	13360	7100	(31.1)
3.0 m	kg					*11160	6740	8800	4730	5730	2990	9.70
(10 ft)	lb					*24600	14860	19400	10430	12630	6590	(31.8)
1.5 m	kg					12230	6320	8540	4500	5700	2960	9.66
(5 ft)	lb					26960	13930	18830	9920	12570	6530	(31.7)
Ground	kg			*18480	9360	11950	6090	8370	4350	5990	3110	9.34
Line	lb			*40740	20640	26350	13430	18450	9590	13210	6860	(30.6)
-1.5 m	kg	*14420	*14420	*17900	9400	11880	6030	8330	4310	6730	3530	8.72
(-5 ft)	lb	*31790	*31790	*39460	20720	26190	13290	18360	9500	14840	7780	(28.6)
-3.0 m	kg	*22140	19480	*16390	9590	12000	6130			*7930	4450	7.70
(-10 ft)	lb	*48810	42950	*36130	21140	26460	13510			*17480	9810	(25.3)
-4.5 m	kg	*17840	*17840	*13410	9980							
(-15 ft)	lb	*39330	*39330	*29560	22000							

Boom : 6.45m (21' 2") / Arm : 2.5 m (8' 2") / Bucket : 1.44 m³ (1.88 yd³) SAE heaped / Shoe : 600mm (24") triple grouser

Load point height m (ft)		Load radius						At max. reach						
		3.0 m (10 ft)		4.5 m (15 ft)		6.0 m (20 ft)		7.5 m (25 ft)		9.0 m (30 ft)		Capacity		Reach
														m (ft)
7.5 m	kg											*6720	4380	8.34
(25 ft)	lb											*14820	9660	(27.4)
6.0 m	kg						*7320	5200				6520	3530	9.19
(20 ft)	lb						*16140	11460				14370	7780	(30.2)
4.5 m	kg			*11600	11590	*9120	7300	*7930	4990			5820	3070	9.70
(15 ft)	lb			*25570	25550	*20110	16090	*17480	11000			12830	6770	(31.8)
3.0 m	kg			*15130	10350	*10770	6760	*8770	4720			5500	2850	9.92
(10 ft)	lb			*33360	22820	*23740	14900	*19330	10410			12130	6280	(32.5)
1.5 m	kg			*17590	9540	*12210	6300	8520	4470	6330	3280	5460	2800	9.88
(5 ft)	lb			*38780	21030	*26920	13890	18780	9850	13960	7230	12040	6170	(32.4)
Ground	kg			*18360	9270	11890	6030	8320	4300			5720	2930	9.57
Line	lb			*40480	20440	26210	13290	18340	9480			12610	6460	(31.4)
-1.5 m	kg	*15010	*15010	*18010	9260	11790	5940	8250	4240			6370	3300	8.97
(-5 ft)	lb	*33090	*33090	*39710	20410	25990	13100	18190	9350			14040	7280	(29.4)
-3.0 m	kg	*22800	19140	*16720	9430	11870	6010					7780	4110	7.98
(-10 ft)	lb	*50270	42200	*36860	20790	26170	13250					17150	9060	(26.2)
-4.5 m	kg	*19110	*19110	*14080	9780	*10340	6290					*7300	6090	6.42
(-15 ft)	lb	*42130	*42130	*31040	21560	*22800	13870					*16090	13430	(21.1)

1. Lifting capacity is based on SAE J1097, ISO 10567.

2. Lifting capacity of the Robex Series does not exceed 75% of the tipping load with the machine on firm, level ground or 87% of full hydraulic capacity.

3. The load point is a hook located on the back of the bucket.















4. (*) indicates the load limited by hydraulic capacity.

Lifting Capacity















R330NLC-9A

 Rating over-front  Rating over-side or 360 degree

Boom : 6.45m (21' 2") / Arm : 3.2 m (10' 6") / Bucket : 1.44 m³ (1.88 yd³) SAE heaped / Shoe : 600mm (24") triple grouser

Load point height m (ft)	Load radius												At max. reach			
	1.5 m (5 ft)		3.0 m (10 ft)		4.5 m (15 ft)		6.0 m (20 ft)		7.5 m (25 ft)		9.0 m (30 ft)		Capacity		Reach	
															m (ft)	
7.5 m (25 ft)	kg									*5240	*5240			*5970	3780	9.06
	lb									*11550	*11550			*13160	8330	(29.7)
6.0 m (20 ft)	kg									*6500	5310			5810	3100	9.84
	lb									*14330	11710			12810	6830	(32.3)
4.5 m (15 ft)	kg							*8090	7460	*7190	5060	*5440	3560	5240	2710	10.31
	lb							*17840	16450	*15850	11160	*11990	7850	11550	5970	(33.8)
3.0 m (10 ft)	kg				*13400	10720	*9820	6870	*8110	4750	6480	3410	4960	2510	10.52	
	lb				*29540	23630	*21650	15150	*17880	10470	14290	7520	10930	5530	(34.5)	
1.5 m (5 ft)	kg				*16400	9700	*11460	6340	8520	4460	6300	3250	4910	2460	10.48	
	lb				*36160	21380	*25260	13980	18780	9830	13890	7170	10820	5420	(34.4)	
Ground Line	kg			*10240	*10240	*17910	9210	11850	5980	8260	4230	6170	3130	5090	2550	10.19
	lb			*22580	*22580	*39480	20300	26120	13180	18210	9330	13600	6900	11220	5620	(33.4)
-1.5 m (-5 ft)	kg	*11380	*11380	*14470	*14470	*18150	9070	11650	5810	8130	4120			5580	2820	9.63
	lb	*25090	*25090	*31900	*31900	*40010	20000	25680	12810	17920	9080			12300	6220	(31.6)
-3.0 m (-10 ft)	kg	*15350	*15350	*19470	18530	*17370	9140	11650	5810	8130	4120			6590	3400	8.74
	lb	*33840	*33840	*42920	40850	*38290	20150	25680	12810	17920	9080			14530	7500	(28.7)
-4.5 m (-15 ft)	kg			*21820	19060	*15410	9400	*11430	5980					*7480	4680	7.37
	lb			*48100	42020	*33970	20720	*25200	13180					*16490	10320	(24.2)
-6.0 m (-20 ft)	kg					*11340	9950									
	lb					*25000	21940									











Boom : 6.45m (21' 2") / Arm : 4.05 m (13' 3") / Bucket : 1.44 m³ (1.88 yd³) SAE heaped / Shoe : 600mm (24") triple grouser

Load point height m (ft)	Load radius												At max. reach			
	1.5 m (5 ft)		3.0 m (10 ft)		4.5 m (15 ft)		6.0 m (20 ft)		7.5 m (25 ft)		9.0 m (30 ft)		Capacity		Reach	
															m (ft)	
7.5 m (25 ft)	kg													*5250	3120	10.00
	lb													*11570	6880	(32.8)
6.0 m (20 ft)	kg											*4530	3780	5020	2610	10.71
	lb											*9990	8330	11070	5750	(35.1)
4.5 m (15 ft)	kg									*6270	5210	*5750	3650	4580	2310	11.13
	lb									*13820	11490	*12680	8050	10100	5090	(36.5)
3.0 m (10 ft)	kg			*18220	*18220	*11250	*11250	*8610	7130	*7280	4870	*6530	3460	4350	2140	11.32
	lb			*40170	*40170	*24800	*24800	*18980	15720	*16050	10740	*14400	7630	9590	4720	(37.1)
1.5 m (5 ft)	kg			*10440	*10440	*14750	10140	*10470	6520	*8360	4540	6340	3270	4300	2090	11.29
	lb			*23020	*23020	*32520	22350	*23080	14370	*18430	10010	13980	7210	9480	4610	(37.0)
Ground Line	kg			*10810	*10810	*17060	9390	*11950	6070	8300	4260	6150	3110	4430	2150	11.03
	lb			*23830	*23830	*37610	20700	*26350	13380	18300	9390	13560	6860	9770	4740	(36.2)
-1.5 m (-5 ft)	kg	*9850	*9850	*13390	*13390	*18030	9060	11650	5800	8090	4080	6040	3000	4780	2340	10.52
	lb	*21720	*21720	*29520	*29520	*39750	19970	25680	12790	17840	8990	13320	6610	10540	5160	(34.5)
-3.0 m (-10 ft)	kg	*13020	*13020	*16980	*16980	*17900	9000	11540	5710	8020	4010	6030	2990	5470	2740	9.72
	lb	*28700	*28700	*37430	*37430	*39460	19840	25440	12590	17680	8840	13290	6590	12060	6040	(31.9)
-4.5 m (-15 ft)	kg	*16670	*16670	*21800	18540	*16680	9140	11630	5780	8100	4080			6860	3540	8.53
	lb	*36750	*36750	*48060	40870	*36770	20150	25640	12740	17860	8990			15120	7800	(28.0)
-6.0 m (-20 ft)	kg			*20030	19240	*13950	9510	*10120	6050					*6790	5510	6.71
	lb			*44160	42420	*30750	20970	*22310	13340					*14970	12150	(22.0)

R330LC-9A HIGH WALKER

 Rating over-front  Rating over-side or 360 degree

Boom : 6.45m (21' 2") / Arm : 2.2 m (7' 3") / Bucket : 1.44 m³ (1.88 yd³) SAE heaped / Shoe : 600mm (24") triple grouser

Load point height m (ft)	Load radius								At max. reach			
	3.0 m (10 ft)		4.5 m (15 ft)		6.0 m (20 ft)		7.5 m (25 ft)		Capacity		Reach	
											m (ft)	
7.5 m (25 ft)	kg									*7120	6060	8.27
	lb									*15700	13360	(27.1)
6.0 m (20 ft)	kg					*8420	*8420	*7770	7050	*7190	5040	9.07
	lb					*18560	*18560	*17130	15540	*15850	11110	(29.8)
4.5 m (15 ft)	kg			*13030	*13030	*9840	9840	*8390	6830	6630	4520	9.53
	lb			*28730	*28730	*21690	21690	*18500	15060	14620	9960	(31.3)
3.0 m (10 ft)	kg					*11450	9290	*9200	6570	6340	4290	9.71
	lb					*25240	20480	*20280	14480	13980	9460	(31.9)
1.5 m (5 ft)	kg					*12720	8880	9390	6340	6370	4300	9.62
	lb					*28040	19580	20700	13980	14040	9480	(31.6)
Ground Line	kg			*18430	13590	13140	8670	9240	6210	6770	4570	9.25
	lb			*40630	29960	28970	19110	20370	13690	14930	10080	(30.3)
-1.5 m (-5 ft)	kg	*16090	*16090	*17690	13670	13110	8640	9230	6190	7680	5210	8.56
	lb	*35470	*35470	*39000	30140	28900	19050	20350	13650	16930	11490	(28.1)
-3.0 m (-10 ft)	kg	*21530	*21530	*15980	13910	*12030	8780			*7840	6620	7.45
	lb	*47470	*47470	*35230	30670	*26520	19360			*17280	14590	(24.4)
-4.5 m (-15 ft)	kg			*12550	*12550							
	lb			*27670	*27670							

Lifting Capacity

R330LC-9A HIGH WALKER

Rating over-front Rating over-side or 360 degree

Boom : 6.45m (21' 2") / Arm : 2.5 m (8' 2") / Bucket : 1.44 m³ (1.88 yd³) SAE heaped / Shoe : 600mm (24") triple grouser

Load point height m (ft)		Load radius										At max. reach		
		3.0 m (10 ft)		4.5 m (15 ft)		6.0 m (20 ft)		7.5 m (25 ft)		9.0 m (30 ft)		Capacity		Reach m (ft)
7.5 m (25 ft)	kg											*6730	5760	8.53
	lb											*14840	12700	(28.0)
6.0 m (20 ft)	kg							*7410	7080			*6840	4820	9.31
	lb							*16340	15610			*15080	10630	(30.5)
4.5 m (15 ft)	kg			*12260	*12260	*9420	*9420	*8070	6850			6370	4330	9.76
	lb			*27030	*27030	*20770	*20770	*17790	15100			14040	9550	(32.0)
3.0 m (10 ft)	kg			*15720	14470	*11070	9310	*8930	6560	7140	4840	6090	4110	9.93
	lb			*34660	31900	*24410	20530	*19690	14460	15740	10670	13430	9060	(32.6)
1.5 m (5 ft)	kg			*17850	13710	*12430	8860	9370	6310			6120	4110	9.84
	lb			*39350	30230	*27400	19530	20660	13910			13490	9060	(32.3)
Ground	kg			*18370	13490	13080	8610	9190	6150			6460	4340	9.48
	lb			*40500	29740	28840	18980	20260	13560			14240	9570	(31.1)
-1.5 m (-5 ft)	kg	*16360	*16360	*17850	13520	13010	8550	9140	6110			7280	4910	8.82
	lb	*36070	*36070	*39350	29810	28680	18850	20150	13470			16050	10820	(28.9)
-3.0 m (-10 ft)	kg	*22580	*22580	*16360	13730	*12250	8650					*7890	6140	7.75
	lb	*49780	*49780	*36070	30270	*27010	19070					*17390	13540	(25.4)
-4.5 m (-15 ft)	kg	*18050	*18050	*13340	*13340									
	lb	*39790	*39790	*29410	*29410									

Boom : 6.45m (21' 2") / Arm : 3.2 m (10' 6") / Bucket : 1.44 m³ (1.88 yd³) SAE heaped / Shoe : 600mm (24") triple grouser

Load point height m (ft)		Load radius										At max. reach				
		1.5 m (5 ft)		3.0 m (10 ft)		4.5 m (15 ft)		6.0 m (20 ft)		7.5 m (25 ft)		9.0 m (30 ft)		Capacity		Reach m (ft)
7.5 m (25 ft)	kg									*5730	*5730			*5990	5050	9.24
	lb									*12630	*12630			*13210	11130	(30.3)
6.0 m (20 ft)	kg									*6600	*6600			*6130	4300	9.95
	lb									*14550	*14550			*13510	9480	(32.6)
4.5 m (15 ft)	kg							*8400	*8400	*7350	6920	*5820	5000	5770	3880	10.37
	lb							*18520	*18520	*16200	15260	*12830	11020	12720	8550	(34.0)
3.0 m (10 ft)	kg					*14050	*14050	*10150	9420	*8290	6590	7170	4840	5530	3680	10.53
	lb					*30970	*30970	*22380	20770	*18280	14530	15810	10670	12190	8110	(34.5)
1.5 m (5 ft)	kg					*16800	13850	*11720	8890	*9210	6290	7000	4680	5530	3670	10.45
	lb					*37040	30530	*25840	19600	*20300	13870	15430	10320	12190	8090	(34.3)
Ground	kg			*10990	*10990	*18040	13400	*12750	8540	9150	6080	6880	4570	5790	3840	10.11
	lb			*24230	*24230	*39770	29540	*28110	18830	20170	13400	15170	10080	12760	8470	(33.2)
-1.5 m (-5 ft)	kg	*12090	*12090	*15330	*15330	*18080	13300	12910	8400	9040	5980			6400	4260	9.50
	lb	*26650	*26650	*33800	*33800	*39860	29320	28460	18520	19930	13180			14110	9390	(31.2)
-3.0 m (-10 ft)	kg	*16150	*16150	*20540	*20540	*17110	13410	*12630	8430	9080	6010			*7560	5140	8.53
	lb	*35600	*35600	*45280	*45280	*37720	29560	*27840	18580	20020	13250			*16670	11330	(28.0)
-4.5 m (-15 ft)	kg			*20940	*20940	*14870	13750	*10980	8660					*7390	7170	7.03
	lb			*46160	*46160	*32780	30310	*24210	19090					*16290	15810	(23.1)

Boom : 6.45m (21' 2") / Arm : 4.05 m (13' 3") / Bucket : 1.44 m³ (1.88 yd³) SAE heaped / Shoe : 600mm (24") triple grouser

Load point height m (ft)		Load radius										At max. reach				
		1.5 m (5 ft)		3.0 m (10 ft)		4.5 m (15 ft)		6.0 m (20 ft)		7.5 m (25 ft)		9.0 m (30 ft)		Capacity		Reach m (ft)
7.5 m (25 ft)	kg											*3030	*3030	*5280	4260	10.16
	lb											*6680	*6680	*11640	9390	(33.3)
6.0 m (20 ft)	kg											*4770	*4770	*5430	3700	10.81
	lb											*10520	*10520	*11970	8160	(35.5)
4.5 m (15 ft)	kg									*6440	*6440	*5980	5100	5050	3370	11.19
	lb									*14200	*14200	*13180	11240	11130	7430	(36.7)
3.0 m (10 ft)	kg			*20040	*20040	*11950	*11950	*8970	*8970	*7490	6710	*6650	4900	4860	3210	11.33
	lb			*44180	*44180	*26350	*26350	*19780	*19780	*16510	14790	*14660	10800	10710	7080	(37.2)
1.5 m (5 ft)	kg			*10150	*10150	*15290	14280	*10790	9070	*8550	6370	7000	4700	4840	3180	11.26
	lb			*22380	*22380	*33710	31480	*23790	20000	*18850	14040	15430	10360	10670	7010	(36.9)
Ground	kg	*7400	*7400	*11200	*11200	*17340	13550	*12170	8620	9140	6090	6830	4540	5030	3300	10.95
	lb	*16310	*16310	*24690	*24690	*38230	29870	*26830	19000	20150	13430	15060	10010	11090	7280	(35.9)
-1.5 m (-5 ft)	kg	*10420	*10420	*13990	*13990	*18090	13260	12840	8370	8960	5930	6730	4450	5460	3610	10.39
	lb	*22970	*22970	*30840	*30840	*39880	29230	28310	18450	19750	13070	14840	9810	12040	7960	(34.1)
-3.0 m (-10 ft)	kg	*13660	*13660	*17770	*17770	*17760	13240	12770	8310	8910	5880			6310	4210	9.53
	lb	*30120	*30120	*39180	*39180	*39150	29190	28150	18320	19640	12960			13910	9280	(31.3)
-4.5 m (-15 ft)	kg	*17430	*17430	*22910	*22910	*16310	13440	*12000	8420	*9020	5990			*7060	5420	8.25
	lb	*38430	*38430	*50510	*50510	*35960	29630	*26460	18560	*19890	13210			*15560	11950	(27.1)
-6.0 m (-20 ft)	kg			*18860	*18860	*13180	*13180	*9410	8760							
	lb			*41580	*41580	*29060	*29060	*20750	19310							

1. Lifting capacity is based on SAE J1097, ISO 10567.

2. Lifting capacity of the Robex Series does not exceed 75% of the tipping load with the machine on firm, level ground or 87% of full hydraulic capacity.

3. The load point is a hook located on the back of the bucket.

4. (*) indicates the load limited by hydraulic capacity.

STANDARD EQUIPMENT

ISO Standard cabin

All-weather steel cab with 360° visibility
Safety glass windows
Rise-up windshield wiper
Sliding fold-in front window
Sliding side window (LH)
Lockable door
Hot & cool box
Storage compartment & ashtray
Transparent cabin roof-cover
Radio / USB player
Handsfree mobile phone system with USB
12 volt power outlet (24V DC to 12V DC converter)
Sun visor

Computer aided power optimization (New CAPO) system

3-power mode, 2-work mode, User mode
Auto deceleration & one-touch deceleration system
Auto warm-up system
Auto overheat prevention system

Automatic climate control

Air conditioner & heater
Defroster

Self-diagnostics system

Starting Aid (air grid heater) for cold weather

Centralized monitoring

LCD display
Engine speed or Trip meter/Accel.
Clock
Gauges
Fuel level gauge
Engine coolant temperature gauge
Hyd. oil temperature gauge
Warnings
Check Engine
Overload
Communication error
Low battery
Air cleaner clogging
Indicators
Max power
Low speed/High speed
Fuel warmer
Auto idle

Door and cab locks, one key

Three outside rearview mirrors

Mechanical suspension seat with heater

Pilot-operated slidable joystick

Console box height adjust system

Four front working lights

Electric horn

Batteries (2 x 12V x 160 AH)

Battery master switch

Removable clean-out dust net for cooler

Automatic swing brake

Removable reservoir tank

Fuel pre-filter with fuel warmer

Boom holding system

Arm holding system

Track shoes (600mm, 24")

Track rail guard

Accumulator for lowering work equipment

Electric transducer

Lower frame under cover (normal)

Viscous fan clutch

OPTIONAL EQUIPMENT

Fuel filler pump (50 L/min)

Beacon lamp

Safety lock valve for boom cylinder with overload warning device

Safety lock valve for arm cylinder

Single-acting piping kit (breaker, etc.)

Double-acting piping kit (clamshell, etc.)

Quick coupler

Travel alarm

Booms

6.15 m, 20' 2"

6.45 m, 21' 2"

6.45 m, 21' 2" Heavy Duty

Arms

2.2 m, 7' 3"

2.5 m, 8' 2"

3.2 m, 10' 6"

3.2 m, 10' 6" Heavy Duty

4.05 m, 13' 3"

Cabin FOPS/FOG (ISO/DIS 10262) Level 2

FOPS (Falling Object Protective Structure)

FOG (Falling Object Guard)

Cabin ROPS (ISO 12117-2)

ROPS (Roll Over Protective Structure)

Cabin roof-steel cover

Cabin lights

Cabin front window rain guard

Track shoes

Triple grousers shoe (700 mm, 28")

Triple grousers shoe (800 mm, 32")

Triple grousers shoe (900 mm, 36")

Double grousers shoe (700 mm, 28")

Full track rail guard

Lower frame under cover (additional)

Pre-heating system, coolant

Tool kit

Operator suit

Rearview camera

Seat

Adjustable air suspension seat with heater

Pattern change valve (2 patterns)

Hi-mate (Remote Management System)

* Standard and optional equipment may vary. Contact your Hyundai dealer for more information. The machine may vary according to international standards.

* The photos may include attachments and optional equipment that are not available in your area.

* Materials and specifications are subject to change without advance notice.

* All imperial measurements rounded off to the nearest pound or inch.

PLEASE CONTACT



6100 Atlanta Blvd Norcross, GA 30071
TEL: (678) 823 7777 FAX: (678) 823 7778