

Robex

# 520LC-9A

With Tier 4 Interim Engine installed

**HYUNDAI HEAVY INDUSTRIES**

MOVING YOU FURTHER



\*Photo may include optional equipment.



# HYUNDAI

CONSTRUCTION EQUIPMENT AMERICAS, INC.



# PRIDE AT WORK

Hyundai Heavy Industries strives to build state-of-the-art earthmoving equipment to give every operator maximum performance, more precision, versatile machine preferences, and proven quality.

*Take pride in your work with Hyundai!*



\*Photo may include optional equipment.

# Robex 520LC-9A

## Machine Walk-Around



### Engine Technology

Proven, reliable, fuel efficient, low emission and low noise  
Cummins Tier 4 interim & EU stage III B engine

### Hydraulic System Improvements

New patented hydraulic control for improved controllability / Improved control valve design for added efficiency and smoother operation / New auto boom and swing priority system for optimum speed / New auto power boost feature for additional power when needed / Improved arm-in and boom-down flow regeneration system for added speed and efficiency

### Pump Compartment

Industry-leading, powerful, reliable Kawasaki designed, variable volume in-line axial piston pumps  
New compact solenoid block equipped with 3 solenoid valves, 1 EPPR valve, 1 check valve accumulator and pilot filter - controls 2 speed travel, power boost, boom priority, safety lock

### Enhanced Operator Cab

#### Improved Visibility

Enlarged cab with improved visibility / See-through upper skylight for visibility and ventilation  
Larger right-side glass, now one piece, for better right visibility  
Safety glass windows on all sides - less expensive than (polycarbonate) and won't scratch or fade  
Closeable sunshade for operator convenience / Reduced front window seam for improved operator view

#### Improved Cab Construction

New steel tube construction for added operator safety, protection and durability  
New window open/close mechanism designed with cable and spring lift assist and single latch release

#### Improved Suspension Seat / Console Assembly

Ergonomic joysticks with auxiliary control buttons for attachment use with new sleek styling  
Heated suspension (standard) or optional air ride suspension with heat  
New joystick consoles - now adjustable in height by pushing a button  
Integrated seat with consoles - reduces the operator fatigue

#### Advanced 7" Color Cluster with Touch Screen

New Color LCD Display with easy to read digital gauges for hydraulic oil temperature, water temperature, and fuel. Simplified design makes adjustment and diagnostics easier. Also, new enhanced features such as rear-view camera are integrated into monitor.

3 power modes : (P) Power, (S) Standard, (E) Economy, 2 work modes : Dig & Attachment, (U) User mode for operator preference

Enhanced self-diagnostic features with GPS download capability

One pump flow or two pump flow for optional attachment is now selectable through the cluster New anti-theft system with password capability

Boom speed and arm regeneration are selectable through the monitor.

Auto power boost is now available - selectable (on/off) through the monitor.

Powerful air conditioning and heat with auto climate control

RMS (Remote Management System) works through GPS/satellite technology to ultimately provide better customer service and support.

### Undercarriage

Sealed track chain (urethane seals) / Standard track rail guard / Comfortable bolt-on steps

Large upper roller cut-outs for debris clean-out / Tapered side frames for debris clean-out / Grease-type track tensioner



# PRECISION

Innovative hydraulic system technologies make the 9A series excavator fast, smooth and easy to control.



\*Photo may include optional equipment.

## Computer Aided Power

The engine horsepower and hydraulic horsepower together in unison through the advanced CAPO (Computer Aided Power Optimization) system flow for the job at hand. Operator can set their own preferences for boom or swing priority, power mode selection and optional work tools at the touch of a button.

The CAPO system also provides complete self-diagnostic features and digital gauges for important information like hydraulic oil temperature, water temperatures and fuel level. This system interfaces with multiple sensors placed throughout the hydraulic system as well as the electronically controlled engine to provide the optimum level of engine power and hydraulic flow.

### Power Mode

P (Power Max) mode maximizes machine speed and power for mass production.

S (Standard) mode provides a reduced, fixed rpm for optimum performance and improved fuel economy. For maximum fuel savings and improved control, E (Economy) mode provides precise flow and engine power based on load demand. Three unique power modes provide the operator with custom power, speed and fuel economy.

### Work Mode

The work mode allows the operator to select single flow attachments like a hydraulic breaker or bi-directional flow attachments like a crusher. Flow settings unique to each attachment can be programmed from within the cluster.

### User Mode

Some jobs require more precise machine settings. Using the versatile U (User) mode, the operator can customize engine speed, pump output, idle speed and other machine settings for the job at hand.

## Improved Hydraulic System



To achieve optimum precision, Hyundai redesigned the hydraulic system to provide the operator with super fine touch and improved controllability. Improved pump flow control reduces flow when controls are not being used to minimize fuel consumption.

Improved spool valves in the control valve are engineered to provide more precise flow to each function with less effort.

Improved hydraulic valves, precision-designed variable volume piston pumps, fine-touch pilot controls, and enhanced travel functions make any operator running a 9A series look like a smooth operator.

Newly improved features include arm-in and boom-down flow regeneration, improved control valve technology and innovative auto boom and swing priority for optimal performance in any application.

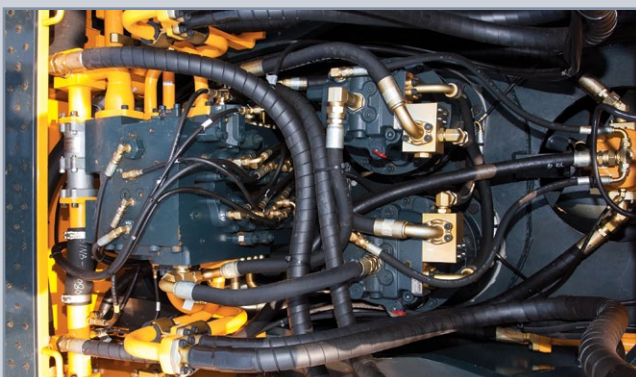

### Auto Boom-swing Priority

This smart function automatically and continuously looks the ideal hydraulic flow balance for the boom and swing motions of the machine. The advanced CAPO system monitors the hydraulic system and adjusts its settings to maximize performance and productivity.



# PERFORMANCE

9A series is designed for maximum performance to keep the operator working productively.



\*Photo may include optional equipment.

## Track Rail Guard & Adjusters

Durable track rail guards keep track links in place. Track adjustment is made easy with standard grease cylinder track adjusters and shock absorbing springs.

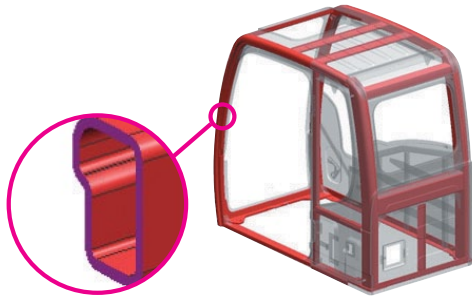

## Structure Strength

The 9A series cabin structure has been fitted with stronger but slimmer tubing for more safety and improved visibility. Low-stress, high strength steel is integrally welded to form a stronger, more durable upper and lower frame. Structural integrity was tested by way of FEM (Finite Elements Method) analysis and long-term durability tests.

## Cummins QSX11.9 Engine

The key to success is building upon your strengths. The proof is Cummins Tier 4 Interim/Stage IIIB QSX11.9. We've taken everything we've learned with the Cummins QSM engine and combined it with the advanced technology platform of the QSX15. The result is a compact engine with 290-500 hp (216-373 kW) and up to 1600 lb-ft (2169 N·m) of peak torque. The QSX11.9 has one of the highest power-to-weight ratios in its class, and its remarkable torque rise (up to 50%) enables the engine to more quickly take full advantage of the torque power – just as rpm speed falls due to tougher working conditions. Reliability, durability and productivity are similar to the QSX15, because the QSX11.9 shares virtually every major component and subsystem. This includes the XPI fuel injection system, Direct Flow air filter, the Cummins CM2250 Electronic Control Module (ECM), proprietary Cummins VGT (Variable Geometry Turbocharger) and the Cummins Particulate Filter.

The addition of the Cummins Particulate Filter reduces particulate matter emissions by over 90%, while the cooled-EGR subsystem reduces NOx emissions by 45%.

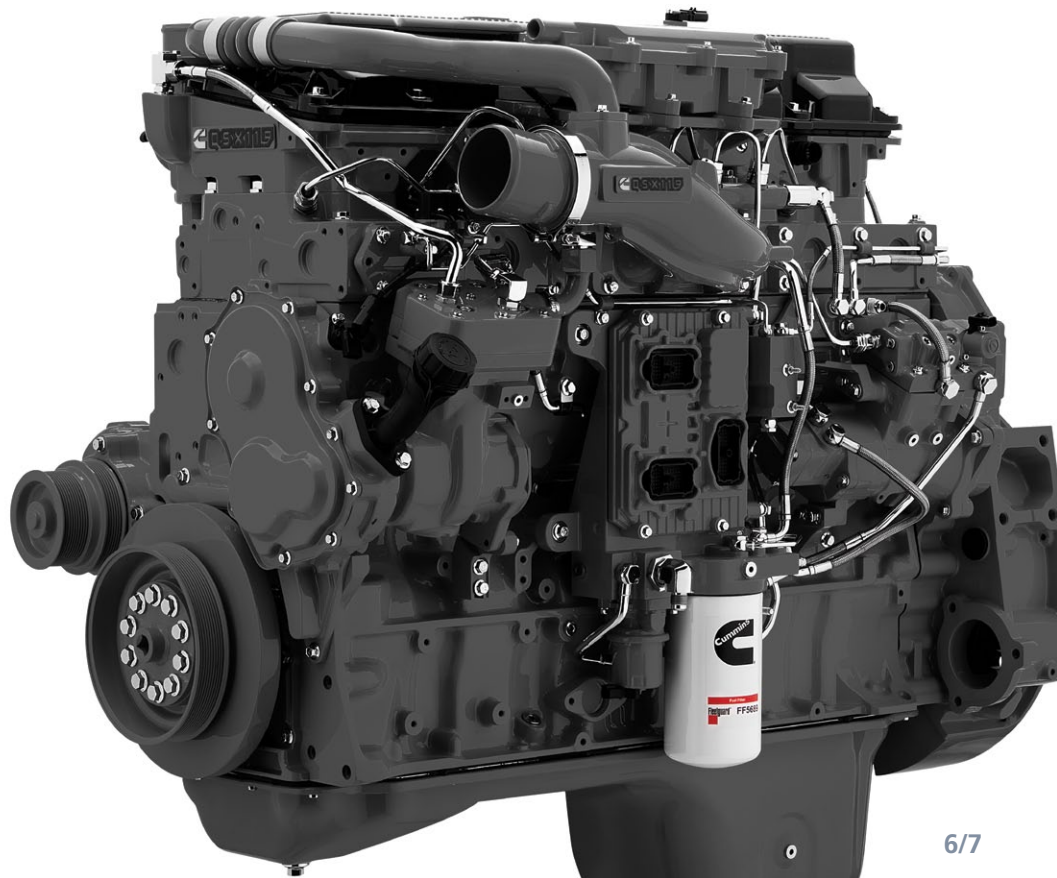



# PREFERENCE

Operating a 9A series is unique to every operator. Operators can fully customize their work environment and operating preferences to fit their individual needs.



\*Photo may include optional equipment.

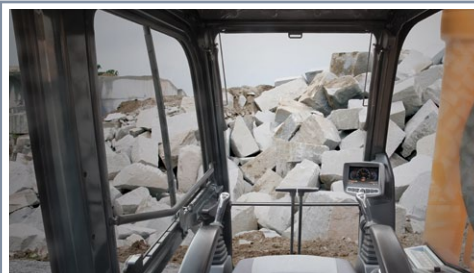

## Wide Cabin with Excellent Visibility

The newly designed cabin has more space, a wider field of view and operator comfort. Special attention was given to a clear, open and convenient interior with plenty of visibility of the machine surroundings and the job at hand. This well-balanced combination of comfort and visibility puts the operator in the perfect position to work safely and securely.



In 9A series cabin you can easily adjust the seat, console and armrest settings to best suit your comfort level. The seat is integrated with console and absorbs console vibration with the seat suspension to reduce operator's fatigue. New joystick consoles are adjustable in height by pushing a button. Other preference settings that add to overall operator comfort include the fully automatic high capacity airconditioning system, transparent polycarbonate glass sun roof, large and easy to control sun visor, and the radio / USB player.

## Operator Comfort



## Reduced Stress

Work is stressful enough. Your work environment should be stress free. Hyundai's 9A series provides improved cab amenities, additional space and a comfortable seat to minimize stress to the operator. A powerful climate control system provides the operator with optimum air temperature. An advanced audio system with USB player, AM/FM stereo and MP3 capabilities, plus remotely located controls, is perfect for listening to your favorite music.

Operators can talk on the phone with the hands-free cell phone feature. Also, the newly designed optional remote control offers mobile hands-free bluetooth and hands-free radio cable function.



## Smart Key System (Option)

9A series excavators provide smart key system as an option. This allows the operator to start the engine by the push of a starter button without inserting a key in the ignition.

## Operator - Friendly Cluster

The advanced new cluster with 7-inch wide color LCD touch screen and toggle switches allows the operator to select his personal machine preferences. Power and work mode selection, self diagnostics, optional rear-view camera, maintenance check lists, start-up machine security, and video functions were integrated into the cluster to make the machine more versatile and the operator more productive.

The newly applied FM transmitter application transmits signal to USB & radio player with the same frequency as the cluster. The player outputs the audio through the internal speaker in the cab. An adjustable cluster hinge bracket improves cluster visibility, and video & firmware updates are easy with the USB host support.



## Monitor Tilt Range



**Horizontal**  
Total : 15°



**Vertical**  
Total : 30°



# PROFITABILITY

9A series is designed to maximize profitability through improved efficiencies, enhanced service features and longer life components.



\*Photo may include optional equipment.





## Hi-mate (Remote Management System)

Hi-mate, Hyundai's proprietary remote management system, provides operators and dealer service personnel access to vital service and diagnostic information on the machine from any computer with internet access. Users can pinpoint machine location using digital mapping and set machine work boundaries, reducing the need for multiple service calls. Hi-mate saves time and money for the owner and dealer by promoting preventative maintenance and reducing machine downtime.

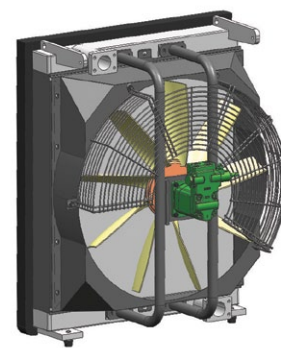
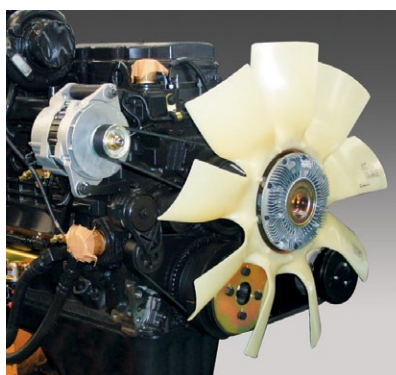

## Fuel Efficiency

9A series excavators are engineered to be extremely fuel efficient. New innovations like fan clutch, the variable speed remote fan, two-stage auto decel system and the new economy mode help to conserve fuel and reduce the impact on the environment.

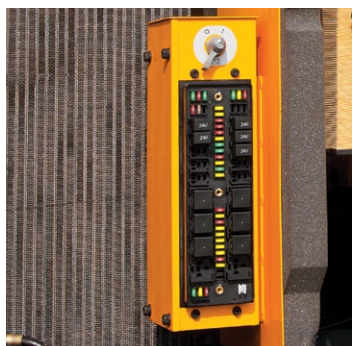

## Easy Access

Ground-line access to filters, lube fittings, fuses, machine computer components and wide open compartments makes service more convenient on the 9A series.



## Long-Life Components

9A series excavators were designed with bushings with long-life lube intervals (250 hrs), polymer shims (wear resistant, noise reducing), long-life hydraulic filters (1,000hrs), long-life hydraulic oil (5,000hrs), more efficient cooling systems and integrated preheating systems which extend service intervals, minimize operating costs and reduce machine down time.

# Specifications

## ENGINE

MODEL		CUMMINS QSX11.9 ENGINE	
Type		Water-cooled, 4-cycle Diesel, 6-cylinder in-line, Direct injection, Turbocharged, Charger air cooled, Low emission	
Rated flywheel horsepower	SAE	J1995 (gross)	372HP (277kW)/ 1,800rpm
		J1349 (net)	352HP (263kW)/ 1,800rpm
	DIN	6271/1 (gross)	377PS (277kW)/ 1,800rpm
		6271/1 (net)	357PS (263kW)/ 1,800rpm
Max. torque		186.7kgf·m (1,350lb·ft)/ 1,400rpm	
Bore X stroke		130mm X 150mm (5.12" X 5.91")	
Piston displacement		11,900cc (726 in <sup>3</sup> )	
Batteries		2 X 12V X 200AH	
Starting motor		24V, 7.2kW	
Alternator		24V, 105Amp	

## HYDRAULIC SYSTEM

MAIN PUMP	
Type	Variable displacement tandem-axial piston pumps
Max. flow	2 X 360 L/min (95.1 US gpm / 79.2 UK gpm)
Sub-pump for pilot circuit	Gear pump

Cross-sensing and fuel saving pump system

### HYDRAULIC MOTORS

Travel	Two-speed axial pistons motor with brake valve and parking brake
Swing	Axial piston motor with automatic brake

### RELIEF VALVE SETTING

Implement circuits	330 kgf/cm <sup>2</sup> (4,690 psi)
Travel	330 kgf/cm <sup>2</sup> (4,690 psi)
Power boost (boom, arm, bucket)	360 kgf/cm <sup>2</sup> (5,120 psi)
Swing circuit	285 kgf/cm <sup>2</sup> (4,050 psi)
Pilot circuit	40 kgf/cm <sup>2</sup> (570 psi)
Service valve	Installed

### HYDRAULIC CYLINDERS

No. of cylinder bore X stroke	Boom: 2-170 X 1,570 mm (6.7" X 61.8")
	Arm: 1-190 X 1,820 mm (7.5" X 71.7")
	Bucket: 1-170 X 1,370 mm (6.7" X 53.9")

## DRIVES & BRAKES

Drive method	Fully hydrostatic type
Drive motor	Axial piston motor, in-shoe design
Reduction system	Planetary reduction gear
Max. drawbar pull	38,500 kgf (82,000 lbf)
Max. travel speed (high / low)	4.8 km/hr (3.0 mph) / 3.1 km/hr (1.9 mph)
Gradeability	35° (70 %)
Parking brake	Multi wet disc

## CONTROL

Pilot pressure operated joysticks and pedals with detachable lever provide almost effortless and fatigueless operation.

Pilot control	Two joysticks with one safety lever (LH): Swing and arm, (RH): Boom and bucket (ISO)
Traveling and steering	Two levers with pedals
Engine throttle	Electric, Dial type

## SWING SYSTEM

Swing motor	Axial piston motor
Swing reduction	Planetary gear reduction
Swing bearing lubrication	Grease-bathed
Swing brake	Multi wet disc
Swing speed	8.2 rpm

## COOLANT & LUBRICANT CAPACITY

Re-filling	liter	US gal	UK gal
Fuel tank	621.0	164.0	136.6
Engine coolant	60	15.9	13.2
Engine oil	41.6	10.1	9.2
Swing device(each) - gear oil	5.0	1.3	1.1
Final drive (each) - gear oil	5.0	1.3	1.1
Hydraulic system (including tank)	380.0	100.4	83.6
Hydraulic tank	262.0	69.2	57.6

## UNDERCARRIAGE

The X-leg type center frame is integrally welded with reinforced box-section track frames. The undercarriage includes lubricated rollers, idlers, track adjusters with shock absorbing springs and sprockets, and a track chain with double or triple grouser shoes.

Center frame	X-leg type
Track frame	Pentagonal box type
No. of shoes on each side	53
No. of carrier rollers on each side	3
No. of track rollers on each side	9
No. of rail guards on each side	2

## OPERATING WEIGHT (APPROXIMATE)

Operating weight, including 7,060mm (23' 2") boom, 3,380mm (11' 1") arm, SAE heaped 2.15m<sup>3</sup> (2.81 yd<sup>3</sup>) bucket, lubricant, coolant, full fuel tank, full hydraulic tank, and all standard equipments.

### MAJOR COMPONENT WEIGHT

Upperstructure	11,210kg (24,710lb)
Boom (with arm cylinder)	4,140kg (9,130lb)

### OPERATING WEIGHT

Shoes	Operating weight	Ground pressure	
Type	Width mm (in)	kg (lb)	
Triple grouser	600 mm (24")	51,000 (112,440)	0.88 (12.51)
	700 mm (28")	51,540 (113,630)	0.76 (10.81)
	750 mm (30")	51,810 (114,220)	0.72 (10.24)
	800 mm (32")	52,080 (114,820)	0.67 (9.53)
Double grouser	600 mm (24")	51,000 (112,440)	0.88 (12.51)
	700 mm (28")	51,540 (113,630)	0.76 (10.81)



## BUCKETS

All buckets are welded with high-strength steel.



SAE  
heaped  
m<sup>3</sup> (yd<sup>3</sup>)

1.00 (1.31)  
1.38 (1.80)

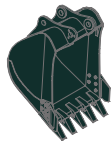

1.65 (2.16)  
2.15 (2.81)  
2.79 (3.65)

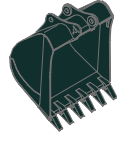

3.03 (3.96)



● 1.80 (2.35)  
● 2.70 (3.53)  
● 3.20 (4.19)



■ 2.20 (2.88)

Capacity m <sup>3</sup> (yd <sup>3</sup> )		Width mm (in)		Weight kg (lb)	Recommendation mm (ft-in)					
SAE heaped	CECE heaped	Without sidecutters	With sidecutters		7,060 (23' 2") Boom				6,550 (21' 6") Boom	9,000 (29' 6") Boom
					2,400 (7' 10") Arm	2,900 (9' 6") Arm	3,380 (11' 1") Arm	4,000 (13' 1") Arm	2,400 (7' 10") Arm	5,850 (19' 2") Arm
1.00 (1.31)	0.9 (1.18)	915 (36.0)	1,065 (41.9)	1,220 (2,690)	-	-	-	-	-	●
1.38 (1.80)	1.25 (1.63)	1,100 (43.3)	1,250 (49.2)	1,420 (3,130)	-	-	-	-	-	■
1.65 (2.16)	1.48 (1.94)	1,140 (44.9)	1,290 (50.8)	1,520 (3,350)	●	●	●	■	●	-
2.15 (2.81)	1.92 (2.51)	1,415 (55.7)	1,565 (61.6)	1,740 (3,840)	●	●	■	▲	●	-
2.79 (3.65)	2.47 (3.23)	1,760 (69.3)	1,910 (75.2)	1,960 (4,320)	■	■	▲	-	●	-
3.03 (3.96)	2.67 (3.49)	1,890 (74.4)	2,040 (80.3)	2,090 (4,610)	▲	▲	-	-	■	-
■ 2.20 (2.88)	1.80 (2.35)	1,840 (72.4)	-	2,170 (4,780)	●	●	■	-	●	-
● 1.80 (2.35)	1.50 (1.96)	1,560 (61.4)	-	2,110 (4,650)	●	●	■	-	●	-
● 2.70 (3.53)	2.5 (3.27)	1,790 (70.5)	-	2,715 (5,990)	▲	-	-	-	■	-
● 3.20 (4.19)	2.80 (3.66)	2,095 (82.5)	-	2,900 (6,390)	-	-	-	-	■	-

■ Heavy duty bucket

● Rock-Heavy duty bucket

●: Applicable for materials with density of 2,000 kg/m<sup>3</sup> (3,370 lb/ yd<sup>3</sup>) or less

■: Applicable for materials with density of 1,600 kg/m<sup>3</sup> (2,700 lb/ yd<sup>3</sup>) or less

▲: Applicable for materials with density of 1,100 kg/m<sup>3</sup> (1,850 lb/ yd<sup>3</sup>) or less

## ATTACHMENT

Booms and arms are welded with a low-stress, full-box section design. 6,550mm (21' 6"), 7,060mm (23' 2"), 9,000mm (29' 6") booms and 2,400mm (7' 10"), 2,900mm (9' 6"), 3,380mm (11' 1"), 4,000mm (13' 1"), 5,850mm (19' 2") arms are available.

## DIGGING FORCE

Boom	Length	mm (ft-in)	7,060 (23' 2")				Remarks
	Weight	kg (lb)	3,260 (7,180)				
Arm	Length	mm (ft-in)	2,400 (7' 10")	2,900 (9' 6")	3,380 (11' 1")	4,000 (13' 1")	Remarks
	Weight	kg (lb)	2,370 (5,220)	2,540 (5,600)	2,380 (5,250)	2,670 (5,890)	
Bucket digging force	SAE	kN	247.1 [269.6]	251.1 [273.9]	253.0 [276.0]	253.0 [276.0]	[ ]: Power Boost
		kgf	25,200 [27,490]	25,600 [27,930]	25,800 [28,150]	25,800 [28,150]	
		lbf	55,560 [60,610]	56,440 [61,570]	56,880 [62,050]	56,880 [62,050]	
	ISO	kN	286.4 [312.4]	290.3 [316.7]	292.2 [318.8]	292.2 [318.8]	
		kgf	29,200 [31,850]	29,600 [32,290]	29,800 [32,510]	29,800 [32,510]	
		lbf	64,370 [70,220]	65,260 [71,190]	65,700 [71,670]	65,700 [71,670]	
Arm crowd force	SAE	kN	278.5 [303.8]	225.6 [246.1]	192.2 [209.7]	171.6 [187.2]	[ ]: Power Boost
		kgf	28,400 [30,980]	23,000 [25,090]	19,600 [21,380]	17,500 [19,090]	
		lbf	62,610 [68,300]	50,710 [55,320]	43,210 [47,140]	38,580 [42,090]	
	ISO	kN	291.3 [317.7]	235.4 [256.8]	200.1 [218.2]	177.5 [193.6]	
		kgf	29,700 [32,400]	24,000 [26,180]	20,400 [22,250]	18,100 [19,750]	
		lbf	65,480 [71,430]	52,910 [57,720]	44,970 [49,060]	39,900 [43,530]	

Note: Boom weight includes arm cylinder, piping, and pin

Arm weight includes bucket cylinder, linkage, and pin

# Dimensions & Working Range

## R520LC-9A DIMENSIONS

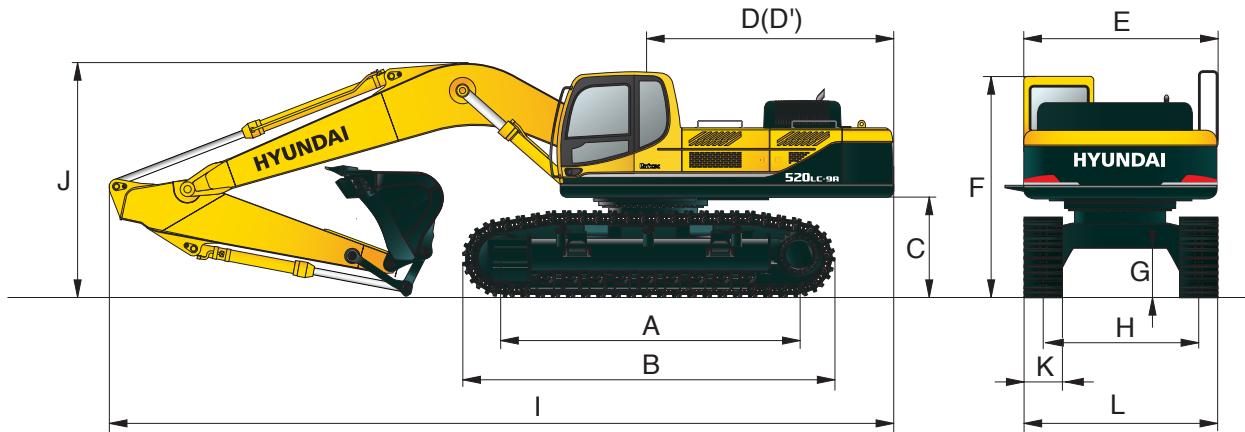

		mm (ft-in)						
A	Tumbler distance	4,470 (14' 8")						
B	Overall length of crawler	5,460 (17' 11")						
C	Ground clearance of counterweight	1,500 (4' 11")						
D	Tail swing radius	3,910 (12' 10")						
D'	Rear-end length	3,855 (12' 8")						
E	Overall width of upperstructure	2,980 (9' 9")						
F	Overall height of cab	3,400 (11' 2")						
G	Min. ground clearance	770 (2' 6")						
H	Track gauge (Extended/Retracted)	2,940 (9' 8")/2,380 (7' 10")						
		Boom length	7,060 (23' 2")			6,550 (21' 6")	9,000 (29' 6")	
		Arm length	2,400 (7' 10")	2,900 (9' 6")	3,380 (11' 1")	4,000 (13' 1")	2,400 (7' 10")	5,850 (19' 2")
I		Overall length	12,280 (40' 3")	12,180 (40' 0")	12,060 (39' 7")	12,050 (39' 6")	11,780 (38' 8")	13,800 (45' 3")
J		Overall height of boom	3,970 (13' 0")	3,880 (12' 9")	3,850 (12' 8")	4,100 (13' 5")	4,100 (13' 5")	5,190 (17' 0")
K		Track shoe width	600 (24")	700 (28")	750 (30")	800 (32")		
L		Overall width	Extended	3,540 (11' 7")	3,640 (11' 11")	3,690 (12' 1")	3,740 (12' 3")	
			Retracted	2,990 (9' 10")	3,080 (10' 1")	3,130 (10' 3")	3,180 (10' 5")	

## R520LC-9A WORKING RANGE

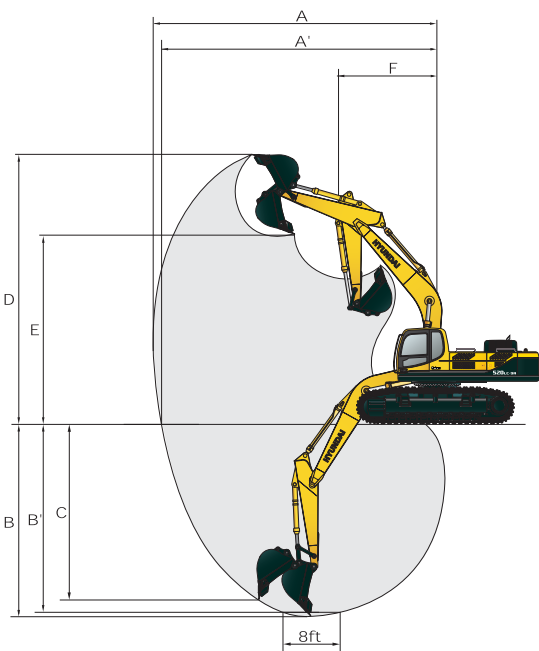

		mm (ft-in)						
		Boom length	7,060 (23' 2")			6,550 (21' 6")	9,000 (29' 6")	
		Arm length	2,400 (7' 10")	2,900 (9' 6")	3,380 (11' 1")	4,000 (13' 1")	2,400 (7' 10")	5,850 (19' 2")
A		Max. digging reach	11,140 (36' 7")	11,530 (37' 10")	12,080 (39' 8")	12,640 (41' 6")	10,590 (34' 9")	16,280 (53' 5")
A'		Max. digging reach on ground	10,890 (35' 9")	11,290 (37' 0")	11,840 (38' 10")	12,420 (40' 9")	10,320 (33' 10")	16,100 (52' 10")
B		Max. digging depth	6,610 (21' 8")	7,110 (23' 4")	7,590 (24' 11")	8,210 (26' 11")	6,130 (20' 1")	11,380 (37' 4")
B'		Max. digging depth (8' level)	6,430 (21' 1")	6,940 (22' 9")	7,440 (24' 5")	8,080 (26' 6")	5,950 (19' 6")	11,280 (37' 0")
C		Max. vertical wall digging depth	4,880 (16' 0")	4,780 (15' 8")	5,470 (17' 11")	5,980 (19' 7")	4,390 (14' 5")	10,070 (33' 0")
D		Max. dumping height	10,640 (34' 11")	10,610 (34' 10")	11,080 (36' 4")	11,290 (37' 0")	10,260 (33' 8")	13,930 (45' 8")
E		Min. swing radius	7,290 (23' 11")	7,350 (24' 1")	7,760 (25' 6")	7,980 (26' 2")	6,920 (22' 8")	10,530 (34' 7")
F		Min. swing radius	5,110 (16' 9")	4,910 (16' 1")	4,830 (15' 10")	4,910 (16' 1")	4,650 (15' 3")	5,940 (19' 6")













# Lifting Capacity











## R520LC-9A

 Rating over-front  Rating over-side or 360 degree

Boom : 6.55m (21' 6") / Arm : 2.40 m (7' 10") / Bucket : 2.15 m' (2.81 yd) SAE heaped / Shoe : 600mm (24") triple grouser

Load point height m (ft)	Load radius								At max. reach			
	3.0 m (10 ft)		4.5 m (15 ft)		6.0 m (20 ft)		7.5 m (25 ft)		Capacity		Reach m (ft)	
												
7.5 m (25 ft)	kg									*9680	9450	8.27
	lb									*21340	20830	(27.1)
6.0 m (20 ft)	kg					*12520	*12520	*10940	10930	*9510	7850	9.07
	lb					*27600	*27600	*24120	24100	*20970	17310	(29.8)
4.5 m (15 ft)	kg		*18820	*18820	*14060	*14060	*11610	10610		*9480	7010	9.53
	lb		*41490	*41490	*31000	*31000	*25600	23390		*20900	15450	(31.3)
3.0 m (10 ft)	kg				*15650	14440	*12390	10200		*9510	6620	9.71
	lb				*34500	31830	*27320	22490		*20970	14590	(31.9)
1.5 m (5 ft)	kg				*16660	13790	*12920	9840		*9540	6600	9.62
	lb				*36730	30400	*28480	21690		*21030	14550	(31.6)
Ground	kg		*22490	21060	*16730	13430	*12920	9610		*9500	6960	9.26
Line	lb		*49580	46430	*36880	29610	*28480	21190		*20940	15340	(30.4)
-1.5 m (-5 ft)	kg	*25000	*25000	*20550	*20550	*15740	13350	*12050	9550	*9220	7870	8.59
	lb	*55120	*55120	*45300	*45300	*34700	29430	*26570	21050	*20330	17350	(28.2)
-3.0 m (-10 ft)	kg	*20980	*20980	*17260	*17260	*13380	*13380			*8260	*8260	7.49
	lb	*46250	*46250	*38050	*38050	*29500	*29500			*18210	*18210	(24.6)
-4.5 m (-15 ft)	kg			*11720	*11720							
	lb			*25840	*25840							

Boom : 7.06m (23' 2") / Arm : 2.40 m (7' 10") / Bucket : 2.15 m' (2.81 yd) SAE heaped / Shoe : 600mm (24") triple grouser

Load point height m (ft)	Load radius								At max. reach				
	3.0 m (10 ft)		4.5 m (15 ft)		6.0 m (20 ft)		7.5 m (25 ft)		9.0 m (30 ft)		Capacity		Reach m (ft)
													
7.5 m (25 ft)	kg						*9860	*9860			*8740	8150	8.92
	lb						*21740	*21740			*19270	17970	(29.3)
6.0 m (20 ft)	kg				*12070	*12070	*10320	*10320			*8630	6890	9.66
	lb				*26610	*26610	*22750	*22750			*19030	15190	(31.7)
4.5 m (15 ft)	kg				*13750	*13750	*11130	10410	*9620	7600	*8620	6210	10.10
	lb				*30310	*30310	*24540	22950	*21210	16760	*19000	13690	(33.1)
3.0 m (10 ft)	kg				*15370	13980	*11980	9950	*9980	7390	*8670	5890	10.26
	lb				*33890	30820	*26410	21940	*22000	16290	*19110	12990	(33.7)
1.5 m (5 ft)	kg				*16320	13350	*12570	9570	*10220	7200	*8720	5870	10.18
	lb				*35980	29430	*27710	21100	*22530	15870	*19220	12940	(33.4)
Ground	kg				*16370	13040	*12680	9340			*8720	6160	9.84
Line	lb				*36090	28750	*27950	20590			*19220	13580	(32.3)
-1.5 m (-5 ft)	kg		*19880	*19880	*15530	13000	*12110	9280			*8550	6880	9.22
	lb		*43830	*43830	*34240	28660	*26700	20460			*18850	15170	(30.2)
-3.0 m (-10 ft)	kg	*20120	*20120	*17240	*17240	*13690	13170	*10450	9420		*7940	*7940	8.22
	lb	*44360	*44360	*38010	*38010	*30180	29030	*23040	20770		*17500	*17500	(27.0)
-4.5 m (-15 ft)	kg			*12990	*12990	*10140	*10140						
	lb			*28640	*28640	*22350	*22350						













- Lifting capacity is based on SAE J1097, ISO 10567.
- Lifting capacity of the Robex Series does not exceed 75% of the tipping load with the machine on firm, level ground or 87% of full hydraulic capacity.
- The load point is a hook located on the back of the bucket.
- (\*) indicates the load limited by hydraulic capacity.

# Lifting Capacity













## R520LC-9A

 Rating over-front  Rating over-side or 360 degree

Boom : 7.06m (23' 2") / Arm : 2.90 m (9' 6") / Bucket : 2.15 m<sup>3</sup> (2.81 yd<sup>3</sup>) SAE heaped / Shoe : 600mm (24") triple grouser

Load point height m (ft)	Load radius										At max. reach			
	3.0 m (10 ft)		4.5 m (15 ft)		6.0 m (20 ft)		7.5 m (25 ft)		9.0 m (30 ft)		Capacity	Reach		
													m (ft)	
7.5 m (25 ft)	kg							*9130	*9130			*8030	7490	9.38
	lb							*20130	*20130			*17700	16510	(30.8)
6.0 m (20 ft)	kg							*9680	*9680			*7980	6390	10.08
	lb							*21340	*21340			*17590	14090	(33.1)
4.5 m (15 ft)	kg			*17520	*17520	*12920	*12920	*10560	10490	*9150	7650	*8020	5780	10.50
	lb			*38620	*38620	*28480	*28480	*23280	23130	*20170	16870	*17680	12740	(34.4)
3.0 m (10 ft)	kg			*21080	*21080	*14680	14130	*11500	9990	*9620	7390	*8110	5480	10.66
	lb			*46470	*46470	*32360	31150	*25350	22020	*21210	16290	*17880	12080	(35.0)
1.5 m (5 ft)	kg			*22550	20650	*15900	13380	*12240	9560	*9990	7150	*8210	5440	10.58
	lb			*49710	45530	*35050	29500	*26980	21080	*22020	15760	*18100	11990	(34.7)
Ground	kg			*22180	20340	*16280	12970	*12550	9260	*10050	6980	*8290	5670	10.26
	lb			*48900	44840	*35890	28590	*27670	20410	*22160	15390	*18280	12500	(33.7)
-1.5 m (-5 ft)	kg	*21080	*21080	*20820	20390	*15780	12830	*12240	9140			*8260	6270	9.66
	lb	*46470	*46470	*45900	44950	*34790	28290	*26980	20150			*18210	13820	(31.7)
-3.0 m (-10 ft)	kg	*23440	*23440	*18490	*18490	*14330	12930	*11060	9200			*7950	7480	8.72
	lb	*51680	*51680	*40760	*40760	*31590	28510	*24380	20280			*17530	16490	(28.6)
-4.5 m (-15 ft)	kg	*18200	*18200	*14780	*14780	*11520	*11520					*6800	*6800	7.30
	lb	*40120	*40120	*32580	*32580	*25400	*25400					*14990	*14990	(24.0)

Boom : 7.06m (23' 2") / Arm : 3.38 m (11' 1") / Bucket : 2.15 m<sup>3</sup> (2.81 yd<sup>3</sup>) SAE heaped / Shoe : 600mm (24") triple grouser

Load point height m (ft)	Load radius										At max. reach			
	3.0 m (10 ft)		4.5 m (15 ft)		6.0 m (20 ft)		7.5 m (25 ft)		9.0 m (30 ft)		Capacity	Reach		
													m (ft)	
7.5 m (25 ft)	kg											*7510	6700	10.00
	lb											*16560	14770	(32.8)
6.0 m (20 ft)	kg							*9190	*9190	*8380	7980	*7470	5810	10.66
	lb							*20260	*20260	*18470	17590	*16470	12810	(35.0)
4.5 m (15 ft)	kg			*16290	*16290	*12260	*12260	*10120	*10120	*8830	7750	*7510	5290	11.05
	lb			*35910	*35910	*27030	*27030	*22310	*22310	*19470	17090	*16560	11660	(36.3)
3.0 m (10 ft)	kg			*20110	*20110	*14150	*14150	*11160	10110	*9380	7470	*7590	5040	11.20
	lb			*44330	*44330	*31200	*31200	*24600	22290	*20680	16470	*16730	11110	(36.7)
1.5 m (5 ft)	kg			*22300	21040	*15600	13560	*12020	9640	*9840	7200	*7680	5000	11.13
	lb			*49160	46390	*34390	29890	*26500	21250	*21690	15870	*16930	11020	(36.5)
Ground	kg			*22570	20490	*16260	13060	*12490	9310	*10050	7000	*7750	5190	10.82
	lb			*49760	45170	*35850	28790	*27540	20530	*22160	15430	*17090	11440	(35.5)
-1.5 m (-5 ft)	kg	*19050	*19050	*21590	20400	*16040	12850	*12390	9130	*9790	6900	*7740	5670	10.26
	lb	*42000	*42000	*47600	44970	*35360	28330	*27320	20130	*21580	15210	*17060	12500	(33.7)
-3.0 m (-10 ft)	kg	*25420	*25420	*19580	*19580	*14900	12870	*11510	9130			*7520	6620	9.40
	lb	*56040	*56040	*43170	*43170	*32850	28370	*25380	20130			*16580	14590	(30.8)
-4.5 m (-15 ft)	kg	*21120	*21120	*16290	*16290	*12560	*12560	*9330	*9330			*6750	*6750	8.11
	lb	*46560	*46560	*35910	*35910	*27690	*27690	*20570	*20570			*14880	*14880	(26.6)
-6.0 m (-20 ft)				*10870	*10870									
				*23960	*23960									

- Lifting capacity is based on SAE J1097, ISO 10567.
- Lifting capacity of the Robex Series does not exceed 75% of the tipping load with the machine on firm, level ground or 87% of full hydraulic capacity.
- The load point is a hook located on the back of the bucket.
- (\*.) indicates the load limited by hydraulic capacity.

















# Lifting Capacity















## R520LC-9A

 Rating over-front  Rating over-side or 360 degree

Boom : 7.06m (23' 2") / Arm : 4.00 m (13' 1") / Bucket : 2.15 m' (2.81 yd') SAE heaped / Shoe : 600mm (24") triple grouser

Load point height m (ft)		Load radius												At max. reach		
		3.0 m (10 ft)		4.5 m (15 ft)		6.0 m (20 ft)		7.5 m (25 ft)		9.0 m (30 ft)		10.5 m (35 ft)		Capacity		Reach
																m (ft)
7.5 m (25 ft)	kg									*6160	*6160			*6770	5950	10.64
	lb									*13580	*13580			*14930	13120	(34.9)
6.0 m (20 ft)	kg									*7670	*7670			*6770	5200	11.26
	lb									*16910	*16910			*14930	11460	(36.9)
4.5 m (15 ft)	kg							*9320	*9320	*8200	7790	*5180	*5180	*6830	4750	11.62
	lb							*20550	*20550	*18080	17170	*11420	*11420	*15060	10470	(38.1)
3.0 m (10 ft)	kg			*18340	*18340	*13130	*13130	*10450	10170	*8830	7470	*6760	5620	*6920	4520	11.77
	lb			*40430	*40430	*28950	*28950	*23040	22420	*19470	16470	*14900	12390	*15260	9960	(38.6)
1.5 m (5 ft)	kg			*21260	*21260	*14840	13650	*11460	9640	*9410	7150	*7540	5450	*7030	4480	11.70
	lb			*46870	*46870	*32720	30090	*25260	21250	*20750	15760	*16620	12020	*15500	9880	(38.4)
Ground	kg	*13810	*13810	*22360	20460	*15850	13020	*12130	9240	*9780	6900	*6850	5310	*7130	4620	11.41
Line	lb	*30450	*30450	*49300	45110	*34940	28700	*26740	20370	*21560	15210	*15100	11710	*15720	10190	(37.4)
-1.5 m (-5 ft)	kg	*18040	*18040	*22000	20150	*16010	12700	*12290	8990	*9780	6750			*7190	5000	10.88
	lb	*39770	*39770	*48500	44420	*35300	28000	*27090	19820	*21560	14880			*15850	11020	(35.7)
-3.0 m (-10 ft)	kg	*23040	*23040	*20520	20190	*15290	12620	*11780	8920	*9150	6730			*7110	5740	10.08
	lb	*50790	*50790	*45240	44510	*33710	27820	*25970	19670	*20170	14840			*15670	12650	(33.1)
-4.5 m (-15 ft)	kg	*24400	*24400	*17830	*17830	*13520	12770	*10290	9030					*6710	*6710	8.91
	lb	*53790	*53790	*39310	*39310	*29810	28150	*22690	19910					*14790	*14790	(29.2)
-6.0 m (-20 ft)	kg	*17570	*17570	*13410	*13410	*10090	*10090									
	lb	*38740	*38740	*29560	*29560	*22240	*22240									

Boom : 9.00m (29' 6") / Arm : 5.85 m (19' 2") / Bucket : 1.38 m' (1.80 yd') SAE heaped / Shoe : 600mm (24") triple grouser

Load point height m (ft)		Load radius												At max. reach		
		3.0 m (10 ft)		5.0 m (15 ft)		7.0 m (25 ft)		9.0 m (30 ft)		11.0 m (35 ft)		13.0 m (45 ft)		Capacity		Reach
																m (ft)
10.0 m (35 ft)	kg													*4210	3970	13.66
	lb													*9280	8750	(44.8)
8.0 m (25 ft)	kg									*4750	*4750	*2800	*2800	*4140	3270	14.63
	lb									*10470	*10470	*6170	*6170	*9130	7210	(48.0)
6.0 m (20 ft)	kg									*5130	*5130	*4310	4110	*4130	2840	15.25
	lb									*11310	*11310	*9500	9060	*9110	6260	(50.0)
4.0 m (15 ft)	kg					*8700	*8700	*6790	*6790	*5650	5520	*4910	3900	*4170	2580	15.57
	lb					*19180	*19180	*14970	*14970	*12460	12170	*10820	8600	*9190	5690	(51.1)
2.0 m (5 ft)	kg			*16120	*16120	*10440	*10440	*7740	7260	*6190	5110	*5190	3670	*4230	2470	15.60
	lb			*35540	*35540	*23020	*23020	*17060	16010	*13650	11270	*11440	8090	*9330	5450	(51.2)
Ground	kg			*16710	16170	*11660	9800	*8490	6670	*6630	4760	*5400	3460	*4290	2490	15.35
Line	lb			*36840	35650	*25710	21610	*18720	14700	*14620	10490	*11900	7630	*9460	5490	(50.4)
-2.0 m (-5 ft)	kg	*11290	*11290	*17600	15570	*12130	9250	*8870	6270	*6840	4500	*5410	3320	*4340	2660	14.80
	lb	*24890	*24890	*38800	34330	*26740	20390	*19550	13820	*15080	9920	*11930	7320	*9570	5860	(48.6)
-4.0 m (-15 ft)	kg	*14480	*14480	*16990	15500	*11860	9040	*8750	6090	*6680	4380	*4170	3290	*4330	3030	13.91
	lb	*31920	*31920	*37460	34170	*26150	19930	*19290	13430	*14730	9660	*9190	7250	*9550	6680	(45.6)
-6.0 m (-20 ft)	kg	*18200	*18200	*15010	*15010	*10780	9100	*8000	6110	*5900	4430			*4180	3740	12.60
	lb	*40120	*40120	*33090	*33090	*23770	20060	*17640	13470	*13010	9770			*9220	8250	(41.3)
-8.0 m (-25 ft)	kg	*16860	*16860	*11770	*11770	*8630	*8630	*6210	*6210					*3610	*3610	10.71
	lb	*37170	*37170	*25950	*25950	*19030	*19030	*13690	*13690					*7960	*7960	(35.1)

- Lifting capacity is based on SAE J1097, ISO 10567.
- Lifting capacity of the Robex Series does not exceed 75% of the tipping load with the machine on firm, level ground or 87% of full hydraulic capacity.

- The load point is a hook located on the back of the bucket.
- (\*) indicates the load limited by hydraulic capacity.

## STANDARD EQUIPMENT

### ISO Standard cabin

All-weather steel cab with 360° visibility  
Safety glass windows  
Rise-up windshield wiper  
Sliding fold-in front window  
Sliding side window (LH)  
Lockable door  
Hot & cool box  
Storage compartment & ashtray  
Transparent cabin roof-cover  
Radio / USB player  
Handsfree mobile phone system with USB  
12 volt power outlet (24V DC to 12V DC converter)  
Sun visor

### Computer aided power optimization (New CAPO) system

3-power mode, 2-work mode, User mode  
Auto deceleration & one-touch deceleration system  
Auto warm-up system  
Auto overheat prevention system

### Automatic climate control

Air conditioner & heater  
Defroster

### Self-diagnostics system

### Starting Aid (air grid heater) for cold weather

### Centralized monitoring

LCD display  
Engine speed or Trip meter/Accel.  
Clock  
Gauges  
Fuel level gauge  
Engine coolant temperature gauge  
Hyd. oil temperature gauge  
Warnings  
Check engine  
Overload  
Communication error  
Low battery  
Air cleaner clogging  
Indicators  
Max power  
Low speed/High speed  
Fuel warmer  
Auto idle

### Door and cab locks, one key

### Three outside rearview mirrors

### Mechanical suspension seat with heater

### Pilot-operated slidable joystick

### Console box height adjust system

### Four front working lights

### Electric horn

### Batteries (2 x 12V x 200 AH)

### Battery master switch

### Removable clean-out dust net for cooler

### Automatic swing brake

### Removable reservoir tank

### Fuel pre-filter with fuel warmer

### Boom holding system

### Arm holding system

### Track shoes (600mm, 24")

### Track rail guard

### Accumulator for lowering work equipment

### Electric transducer

### Lower frame under cover (normal)

## OPTIONAL EQUIPMENT

### Fuel filler pump (50 L/min)

### Beacon lamp

### Safety lock valve for boom cylinder with overload warning device

### Safety lock valve for arm cylinder

### Single-acting piping kit (breaker, etc.)

### Double-acting piping kit (clamshell, etc.)

### Quick coupler

### Travel alarm

### Booms

Heavy duty boom (7.06m,23'2")

Short boom (6.55m,21'6")

Long boom (9.0m,29'6")

### Arms

Heavy duty arm (3.38m,11'1")

Super short arm (2.4m,7'10")

Short arm (2.9m,9'6")

Long arm (5.85m,19'2")

### Counterweight

10,200kg (22,490 lb)

10,700kg (23,590 lb)

11,700kg (25,790 lb)

### Cabin FOPS/FOG (ISO/DIS 10262 Level II)

FOPS (Falling Object Protective Structure)

FOG (Falling Object Guard)

### Cabin roof - Steel cover

### Cabin guard - Front

Wire net

Fine net

### Cabin lights

### Cabin front window rain guard

### Track shoes

Triple grousers shoe (700mm, 28")

Triple grousers shoe (750mm, 30")

Triple grousers shoe (800mm, 32")

Double grousers shoe (600mm, 24")

Double grousers shoe (700mm, 28")

Full track rail guard

### Lower frame under cover (additional)

### Pre-heating system, coolant

### Tool kit

### Operator suit

### Rearview camera

### Seat

Adjustable air suspension seat with heater

### Pattern change valve (2 patterns)

### Hi-mate (Remote Management System)

### Automatic lubrication

\* Standard and optional equipment may vary. Contact your Hyundai dealer for more information. The machine may vary according to international standards.

\* The photos may include attachments and optional equipment that are not available in your area.

\* Materials and specifications are subject to change without advance notice.

\* All imperial measurements rounded off to the nearest pound or inch.

PLEASE CONTACT



6100 Atlanta Blvd Norcross, GA 30071  
TEL: (678) 823 7777 FAX: (678) 823 7778