

Farm King

GRAIN HANDLING
PRODUCTS FOR EVERY FARM

Grain Augers | TeleSwing | Grain Cleaners | Roller Mills | Hammer Mills



Farm King Grain Handling: grain augers,
grain cleaners, roller mill and hammer mill

ISO 9001:2015 CERTIFIED



FARM KING PRODUCT LINE-UP

FARM KING PRODUCT CATEGORIES

Grain Handling

Tillage

Application Equipment

Hay Tools

Landscaping Equipment

Allied by Farm King
Commercial Products

FARM-KING.COM

**FARM KING GRAIN HANDLING EQUIPMENT
IS BACKED BY DECADES OF QUALITY
BUILT PRODUCTS FOR JUST ABOUT EVERY
AGRICULTURAL APPLICATION.**

Moving grain and commodities has never been easier than with the full line of Farm King grain augers, unloading augers and grain cleaners. These products are industry leaders because of their structural integrity and ease of use. Stop by your local dealer today and see how Farm King grain handling equipment can improve your bottom line.

TABLE OF CONTENTS

Backsaver Augers

10" / 13" / 16"4

TELE SWING8

Conventional Augers

CX / 8" / 10"12

Movers And Hoppers 14

Utility Auger 18

Unloading Auger..... 19

Grain Cleaning Equipment

Grain Cleaner 48220

Grain Cleaner 36221

Feed Processing Equipment

Roller Mill/Hammer Mill ..23



BACKSAVER AUGER

PRODUCT OVERVIEW

Manufactured for high-capacity with heavy-duty construction

FEATURES

Swing away auger with a self-leveling hopper

Hydraulic mechanical linkage

Scissor lift undercarriage

Load carrying tapered thrust bearing

OPTIONS

Electric or hydraulic winch and hopper mover (std on 16" models)

Working and travel light kits

Model 13114 shown



BACKSAVER AUGER

10", 13" AND 16" MODELS



UNDERCARRIAGE

The scissor lift undercarriage, standard on all Farm King Backsaver Augers, requires less hydraulic pressure to raise and lower the auger. The wide undercarriage is stable and solid while still meeting transport requirements. Once positioned, a shut-off valve on the underside of the auger tube limits the circulation of the hydraulics allowing the auger to maintain its height.

SELF-LEVELING

The self-leveling hopper on the swing-away auger will remain level regardless of auger height. The unique design allows the intake hopper to be loaded on uneven terrain.

Increased flexibility relieves the hopper of unnecessary down pressure on all hopper parts.

SWING-AWAY AUGER

The swing-away auger can be positioned on the right side or left side of the auger, adding flexibility for yards with limited space or restricted access. An optional power mover uses either two hydraulic motors or two electric motors that move the swing-away auger, limiting the physical labor required.



THE FARM KING BACKSAVER AUGER IS DESIGNED AND BUILT BY THE PEOPLE WHO KNOW AND UNDERSTAND YOUR GRAIN HANDLING NEEDS.

With 10", 13" and 16" tubing with lengths up to 124', the operator is able to move large quantities of grain in short periods of time. Transporting the auger has never been easier with a maximum transport height of 13' 6".

[1] Hydraulic controls **[2]** Self-leveling **[3]** Hydraulic hopper mover **[4]** Hydraulic cylinders (model 13114 shown) **[5]** Hydraulic winch **[6]** Undercarriage



[2]



[3]

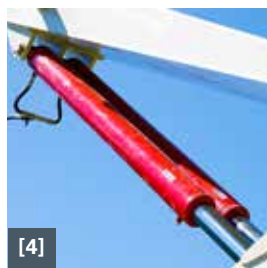

[4]



[5]



[6]

HYDRAULIC CYLINDERS

Powered by a heavy-duty hydraulic cylinder (two on model 13114, shown), the scissor lift undercarriage is capable of holding an auger up to 44°. With the cylinders completely compressed, the auger angle can drop to as low as 5°.

HYDRAULIC WINCH

The optional hydraulic winch easily lifts the hopper into place for transport. The lever and hydraulic valve are mounted to the main auger tube for easy access.

HYDRAULIC HOPPER MOVER

The optional hydraulic hopper mover adds a powerful hydraulic motor to each of the inside wheels on the swing

away hopper so the hopper can be positioned easily and with minimal effort. The control lever for the mover is mounted on the intake auger tube for easy access.

Farm King

PRODUCTS FOR EVERY FARM



[1] Hydraulic drive wheels [2] Adjustable light [3] Gearbox [4] Auger steer (option)

ADJUSTABLE LIGHT

A lighting kit, standard on 16" models, provides light where it is needed most when unloading after hours. One light, located on the swing-away auger, provides light to the hopper and truck unloading area. Another light on the end of the auger tube directs light to the auger spout.

GEARBOXES

These models feature two internal gearboxes for the intake auger assembly. These gearboxes are easy to maintain and service, and do not restrict auger capacity.

AUGER STEER

The auger steer is designed to make modern augers easier to maneuver. The auger steer assembly is attached to the wheel/spindle hub assembly on the axle frame. Two hydraulic cylinders on either side of the auger frame control the side-to-side wheel motion, controlled by the hydraulic system on the tractor.

POWER SWING AND WINCH

An alternative to traditional hydraulic power hopper mover kits, Farm King also offers a full electric mover and winch kit. The battery on your tractor powers the two electric drive motors on the hopper wheels as well as the winch. In addition the kit comes with a remote that can be used to control the hopper from up to 400 feet away.





MEASUREMENTS

MODEL >>	1050	1060	1070	1080*	1370	1385	1395	13114	1684	16104	16124
Wheel track	9'	10'	12'	12'	12'	12'	12'	12' 11"	13' 6"	13' 6"	17' 3"
A, height †											
- lowest	10' 5"	10' 4"	11' 9"	13' 1"	12' 9"	12' 4"	13' 6"	12' 11"	13' 2"	14' 10"	13' 3"
- highest	35' 5"	43' 2"	47' 9"	53' 4"	49' 5"	58' 5"	65'	69' 11"	56' 7"	71' 5"	83' 8"
B, forward reach											
- lowest	24' 7"	29' 10"	35' 10"	45' 9"	37' 4"	46' 3"	56' 1"	63' 7"	43' 9"	57' 3"	71' 2"
- highest	19' 4"	22' 6"	28' 10"	36' 4"	28' 10"	34' 1"	41' 8"	47' 3"	32' 6"	40' 1"	50' 4"

† All measurements taken with 18" hitch height. 'A' lowest is overall transport height and highest are spout to ground measurements. *includes 10' extension.

SPECIFICATIONS

MODEL >>	1050	1060	1070	1080*	1370	1385	1395*	13114	1684	16104	16124	
Size	10" x 50'	10" x 60'	10" x 70'	10" x 80'	13" x 70'	13" x 85'	13" x 95'	13" x 114'	16" x 84"	16" x 104'	16" x 124'	
Tube Thickness	12 gauge				12 gauge				1 and 2: 10 ga. 3 and 4: 11 ga.	1 and 2: 10 ga. 3, 4 and 5: 11 ga.	10 Ga	
Flighting (Measured from centre of flighting strip)	7 gauge				1/4"				1/4"		1/4"	
Flighting shaft	11 gauge, 2-3/8" diameter				11 gauge, 3" diameter				4"		4"	
Undercarriage	3" x 3" x 1/8" square tube				70' - 3-1/2" x 3-1/2" x 3/16" square tube; 85' and 95' - 4" x 4" x 1/4" square tube		5" x 5" x 1/4" square tube	5" x 5" x 1/4" square tube		6" x 6" x 0.188"		
Lift arms	2" x 5" x 3/16" tube				1/4" formed tubing upper, 7 gauge lower				1/4" formed tubing		8" x 3" x 3/8"	
Bridging	3/8" cable on 50' and 60' models, 1/2" cable on 70' and 80' models				1/2" cable				Steel tube trussing	Upper: 3/4" cable Side: 1/2" cable	Upper: 3/4" cable Side: 1/2" cable	Steel tube trussing
Wheels and hubs	5 bolt hubs, 7.60 L x 15 x 6 ply				6 bolt hubs, 9.5 L x 15 x 6 ply	6 bolt hubs, 11 L x 15 x 8 ply		6 bolt hubs, 11 L x 15 x 8 ply	6 bolt hubs, 11 L x 15 x 8 ply	8 bolt hubs, 16.5 L x 16.1 x 10 ply	10 bolt 480/55R22.5	
Hopper dimensions	43-1/2" x 60"				43-1/2" x 60"				48" x 60"		48" x 60"	
Standard hopper height	15-1/4" at heel end, 14-1/4" at other end				16-3/4" at heel end, 16-1/4" at other end				n/a	n/a	n/a	
Multi-flighting hopper height	11-1/2"				13"				15-1/2"	15-1/2"	15-1/2"	
Tractor requirements - min PTO hp (with 540 RPM PTO) - approx. hydraulic requirements for lift	40 hp 1000 PSI	48 hp 1000 PSI	55 hp 1000 PSI	65 hp 1000 PSI	80 hp 1200 PSI	90 hp 1200 PSI	100 hp 1200 PSI	165 hp 1700 PSI	1000 RPM/ PTO 150 hp 1500 PSI	1000 RPM/ PTO 175 hp 1500 PSI	1000 RPM PTO 300 hp 1500 PSI	
Hitch weight	-	-	840 lb	-	1140 lb	1270 lb	-	2700 lb	2,200 lb	2,700 lb	3810 lbs	
Weight	2,545 lb	2,987 lb	3,354 lb	3,622 lb	5,175 lb	6,381 lb	6,683 lb	15,500 lb	11,000 lb	13,000 lb	23010 lbs	



PRODUCT OVERVIEW

Manufactured for operator speed & efficiency

Designed to fit on BackSaver augers

Able to retrofit on 2014 & newer BackSaver augers

Available in either 540 PTO or 1000 PTO

FEATURES

Telescopic intake tube for maximum clearance

Posi-Track dual wheel drive mover

Low profile hopper : easy grain transition from hopper to intake tube



FOR ALL 13" AND 16" BACKSAVER AUGERS

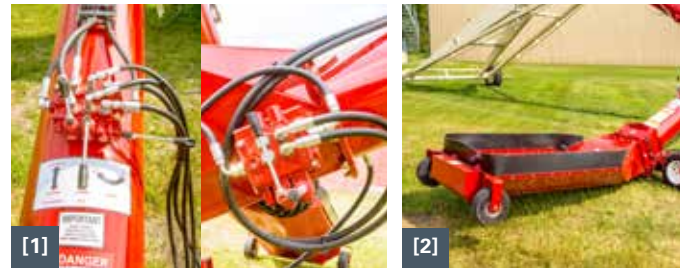

FULLY RETRACTING INTAKE TUBE & HOPPER

The unique design of the system allows the intake tube and hopper to fully retract taking up less space. When fully retracted, the operator can position the truck for unloading and then extend the TeleSwing in position for unloading. Because of this the truck does not need to be moving while the hopper being positioned. This eliminates the difficulties of lining up the hopper with the unload hopper as well as reduces the risk of running over and damaging the hopper.

LOW PROFILE HOPPER

The low profile hopper (13"H) and easier grain transition from hopper to intake tube help maintain optimum capacity.

POSI TRACK DRIVE WHEEL SYSTEM

The Posi-Track dual wheel drive system offers fast and efficient operation. The unit drives both wheels at the same time which distributes more power for moving the hopper into position. Treaded tires keep the unit moving in all yard conditions.



FARM KING 13" & 16" DIAMETER TELESWING

Farm King has built a grain handling option that can accommodate our full line of 13" & 16" BackSaver augers. Enabling the operator to maximize unloading space while keeping efficiency and productivity in mind.



[1] Accessible operating levers [2] Low profile hopper tilts to swing intake into position [3] Posi-Track drive system [4] Hydraulic winch [5] Mounting ring; to fit-up to BackSaver augers [6] Fully retracted [7] Low profile multi-flight hopper

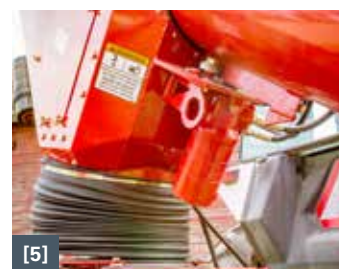
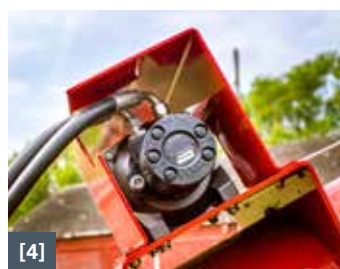

HYDRAULIC CONTROLS & WINCH

The TeleSwing relies on a well routed hydraulic system to provide constant flow and pressure to all control levers. These control levers are conveniently located and are

simple to operate. Visible decals provide clear instructions for safe operation, this helps keep the operator and the equipment safe.

SPECIFICATIONS

MODEL >>	13" TELESWING	16" TELESWING
Tubing gauge	12 gauge	12 gauge
Tubing length	17'	17'
Tube diameter	13"	16"
PTO options	540 or 1000	1000
Hopper dimensions	52" x 45" X 9.25H	52" x 45" X 9.25H
Weight	1450 lbs.	2220 lbs.
Capacity*	11000 bu/hr	18000 bu/hr

* Capacity rating dependent on grain type, moisture, density, % FM. and elevation of main auger.



Reach Higher / Get Closer

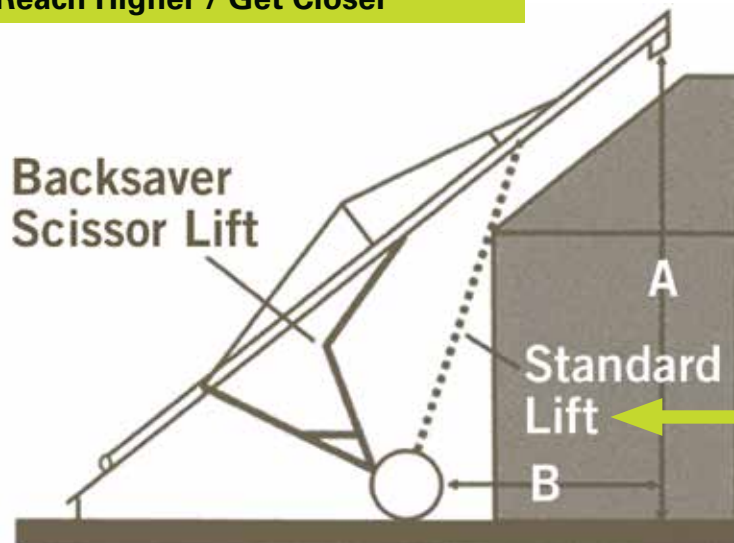

AUGER SELECTION FOR GRAIN BINS

Bin Size*	1050	1060	1070	1080	1370	1385	1395	13114	1684	16104	16124
2404	✓	✓	✓	✓	✓	✓	✓	✓	✓	✓	✓
3006		✓	✓	✓	✓	✓	✓	✓	✓	✓	✓
3008			✓	✓	✓	✓	✓	✓	✓	✓	✓
3010				✓		✓	✓	✓	✓	✓	✓
3012							✓	✓		✓	✓
4206			✓	✓	✓	✓	✓	✓	✓	✓	✓
4208				✓		✓	✓	✓	✓	✓	✓
4210							✓	✓		✓	✓
4212								✓		✓	✓
4806			✓	✓	✓	✓	✓	✓	✓	✓	✓
4808						✓	✓	✓	✓	✓	✓
4810							✓	✓		✓	✓
4812								✓			✓
5408							✓	✓		✓	✓
5410								✓		✓	✓
6008							✓	✓		✓	✓
6010								✓		✓	✓
6012											✓

*Bin size code: 6012 = 60' diameter 12 rings high (each ring is 44"), Roof angle of 28°

BACKSAVER AUGER

Model 13114 shown



CONVENTIONAL AUGER

PRODUCT OVERVIEW

Manufactured for high-capacity with heavy-duty construction

Wide stance undercarriage

Lengths of up to 61'

FEATURES

7 gauge flighting in 10" models

Heavy-duty reversible gearbox

OPTIONS

Multiple drive options available

Poly spout and poly hopper



CONVENTIONAL AUGER

CX SERIES 8" AND 10" MODELS



UNDERCARRIAGE

The wide stance of the undercarriage improves stability and is constructed with square tubes to enhance strength and durability. In addition to being well balanced, the undercarriage features automotive-type hubs and bearings that improve ease of handling.

TOP DRIVE

The top drive is housed in a sealed grease bath and features a chain-tightener. The components in the sealed oil bath are resistant to heat, dust, debris and moisture, reducing maintenance and enhancing the longevity of the chain and sprockets.

TRANSPORT

The sturdy lightweight assembly allows the conventional auger to be easily transported. The trailing swivel wheels can be raised hydraulically to allow for increased turning radius as well as smooth transitions over uneven terrain.

DRIVE OPTIONS

Several drive options are available, including direct PTO, belt-drive PTO, gas engine drive, and electric motor drive matched to a belt or direct drive.



THE CX SERIES OF CONVENTIONAL AUGERS FROM FARM KING ARE AVAILABLE IN LENGTHS OF 41', 51' AND 61' IN BOTH 8" AND 10" DIAMETERS.

The augers feature several enhancements to serviceability and stability and an expanded list of options. Several components have been standardized and redesigned to reduce repair and assembly time as well as to facilitate upgrades. The engine mount and leveling systems have been redesigned to ensure perfect belt tension at any auger position.

[1] Wide stance undercarriage **[2]** Transport (shown with optional auger hopper) **[3]** Top Drive **[4]** Intake **[5]** Poly Hopper **[6]** Poly Spout **[7]** Hardened steel square tubing frame **[8]** Bolt-on wheel spindles



ENGINE MOUNT

The new engine mount has no moving parts for easy set up. The engine is leveled by the belt guard system which ensures perfect belt tension at every auger position - the separate leveling rod has been eliminated.

POLY SPOUT AND HOPPER

Flexible poly spout for accurate filling is optional. Also optional is a poly hopper to minimize spillage.

INTAKE

The intake is an interchangeable, double flighting, supported by a wooden, self lubricating bushing. A narrow safety guard and removable clevis hitch improve access to bins with smaller auger ports. A storage bracket holds the clevis hitch when not in use.

WHEEL SPINDLES

The wheel spindles are a bolt-on style, allowing easy set up and replacement. This also helps facilitate the auger mover installation.





CONVENTIONAL AUGER MOVER



Available for the 8" and 10" CXII auger lineup, the completely redesigned mover incorporates power steering, hydraulic scissor lift for the intake, sport tread tires, hydraulic winch for auger height adjustment, improved engine mount and leveling systems and longer reach on the intake tube. Many parts have been standardized across the models and the kit is designed for ease of assembly, ease of operation and high maneuverability.

MOVER CONTROLS

The auger mover controls are located near the engine controls, allowing for one location control. The belt guarding doubles as the engine leveling device, which keeps the belts at the same tension in any auger position.

CASTER WHEEL

The unique castor wheel design and independently powered drive wheels allow an extremely short turn radius. The intake end scissor lift allows a wide range of vertical motion and tucks up under the auger tube for easy transport.



INTAKE HOPPER



The self-leveling Conventional Auger Hopper adds versatility and convenience to your Farm King auger by giving you a powered intake hopper. The hopper is powered by the rotation of the existing auger core with a CV joint - no new drive mechanisms are needed. With a total reach now extended to approximately 108", this hopper allows you to cleanly collect the discharge of gravity wagons, grain carts, hopper bottom bins, grain trucks, highway grain trailers and more with no spillage, and no need to wrestle with removable hoppers.

HAND-CRANK & CASTER JACK

An optional hand-crank castor jack allows you to lift the intake hopper with ease, and maneuver the auger intake into position with minimal effort.

TRANSPORT

The hopper has a transport stabilizing bar and hitch for quick transport setup without the need to remove the hopper itself. A rubber skirt helps reduce grain spillage.

AUGER MEASUREMENTS

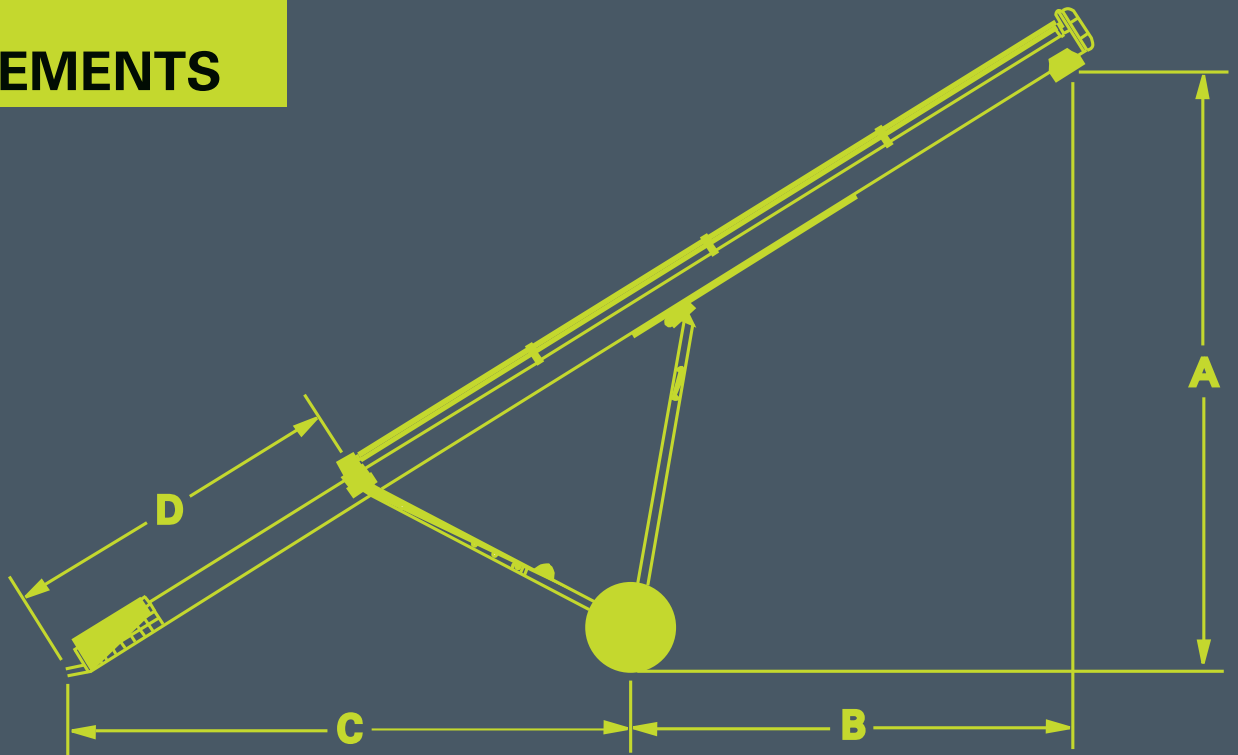

MEASUREMENTS

MODEL >>	CX2-841	CX2-851	CX2-861	CX2-1041	CX2-1051	CX2-1061
A, up	27' 9"	35' 2"	42' 8"	28' 3"	32' 8"	39' 3"
A, down	10' 8"	9' 11"	12' 5"	10' 5"	9' 6"	11' 11"
B, up	12' 5"	17' 3"	20' 3"	13' 3"	16' 9"	20' 4"
B, down	18' 8"	23' 10"	28' 9"	18' 3"	23' 5"	28' 6"
D, direct drive	6' 5"	6' 7"	6' 9"	6' 4"	6' 6"	6' 8"
D, electric & PTO drives	10' 11"	14'	-	10' 11"	14'	16' 1"

SPECIFICATIONS

MODEL >>	CX2-841	CX2-851	CX2-861	CX2-1041	CX2-1051	CX2-1061
Tube width	8"			10"		
Tube length	41'	51'	61'	41'	51'	61'
Wheel track	8' 9"	10' 1"	10' 1"	8' 9"	10' 1"	10' 1"
Belt drives	Double	Double	N/A	Triple	Triple	Triple
Tube, gauge	14	14	14	12	12	12
Flighting, gauge	10	10	10	7	7	7
Flighting shaft, dia.	1-1/4"	1-1/4"	1-1/4"	2-3/8"	2-3/8"	2-3/8"
Flighting shaft, gauge	11 gauge	11 gauge	11 gauge	11 gauge	11 gauge	11 gauge
Drive line	1-3/8"	1-3/8"	1-3/8"	1-3/8"	1-3/8"	1-3/8"
Gasoline						
- Motor pulley	3-1/2"	3-1/2"	N/A	3-1/2"	3-1/2"	4"
- Fuel tank capacity	6.5	6.5	N/A	6.5	6.5	6.5
Motor pulley (tube-mount electric) ⁴	3-3/4"	3-3/4"	3-3/4"	3-3/4"	3-3/4"	3-3/4"
Recommended engine hp	16 hp	20 hp	24 hp	28 hp	32 hp	38 hp
Electric motor hp ⁵	8 hp	10 hp	15 hp	10 hp	15 hp	20 hp

⁴Tube mount kits are recommended to be installed on direct PTO (CX or C) models using pulley diameters shown. Use a 6" motor pulley when installing electric motors on C series engine drive models.

⁵Depends on the type of grain and grain density. Electric hp are estimates only.

CONVENTIONAL AUGERS

PRODUCT OVERVIEW

Manufactured for high-capacity with heavy-duty construction

Wide stance undercarriage

Lengths of up to 36'

FEATURES

1/4" gauge flighting in 13" models

Heavy-duty reversible gearbox

OPTIONS

Multiple drive options available

Poly spout and poly hopper

Truck Loader Auger



CONVENTIONAL AUGER

C SERIES 8" 10" AND 13" MODELS



INTAKE

The double flighting intake increases grain flow. A narrow safety guard and removable clevis hitch improve access to bins with small auger ports.

TOP DRIVE

The top drive is housed in a sealed grease bath and features a chain-tightener. The components in the sealed oil bath are resistant to heat, dust, debris and moisture, reducing maintenance and enhancing the longevity of the chain and sprockets.

POLY SPOUT AND HOPPER

Flexible poly spout for accurate filling is optional. Also optional is a poly hopper to minimize spillage.

GEAR BOX

The gearbox, featuring left- or right-side drive, is positioned to allow the auger to reach deeper into the bin. The ductile casting houses quality oil seals, ball bearings and casehardened, forged gears, meaning the auger runs smoothly and requires less power. 8", 10" and 13" models are available with an optional reverse shift gearbox.



THE STURDY LIGHTWEIGHT ASSEMBLY ALLOWS THE CONVENTIONAL AUGER TO BE EASILY TRANSPORTED. THE TRAILING SWIVEL WHEELS CAN BE RAISED HYDRAULICALLY TO ALLOW FOR INCREASED TURNING RADIUS AS WELL AS SMOOTH TRANSITIONS OVER UNEVEN TERRAIN.

[1] Flexible poly spout for accurate bin filling [2] Hardened steel square tubing frame provides a solid foundation [3] Square flighting connector prevents undue stress on connection bolts



SPECIFICATIONS

MODEL >>	831	836	1031	1036	1336
Tube width	8"		10"		13"
Tube length	31'	36'	31'	36'	36'
Wheel track	6' 0"	6' 6"	6' 0"	6' 6"	7' 5"
Belt drives	Double	Double	Triple	Triple	Triple
Tube, gauge	14	14	14	13	12
Flighting, gauge	10	10	7	7	1/4"
Flighting shaft, dia.	1-1/4"	1-1/4"	2-3/8"	2-3/8"	2-3/8"
Flighting shaft, gauge	11	11	11	11	11
Drive line	1-1/4"	1-1/4"	1-3/8"	1-3/8"	1-1/2"
Gasoline					
- Motor pulley	3.5"	3.5"	3.5"	3.5"	3.5"
- Fuel tank capacity	7 gal	7 gal	7 gal	7 gal	7 gal
Motor pulley (tube-mount electric) ¹	6"	6"	6"	6"	3-3/4"
Recommended engine hp	10-12	10-12	18	22	30
Electric motor hp ²	5	10	10	15	15 (1 phase) / 22 (3 phase)

¹Tube mount kits are recommended to be installed on direct PTO (CX or C) models using pulley diameters shown. Use a 6" motor pulley when installing electric motors on C series engine drive models.

²Depends on the type of grain and grain density. Electric hp are estimates only.



[1] Spider Cage [2] Attaching to grain cleaner
[3] Electric mounting plate



UTILITY AUGER

4", 6" AND 8" MODELS

UTILITY AUGER

PRODUCT OVERVIEW

5' and 10' extensions

10 or 12 gauge flighting

3/4" or 1" sealed top bearing

FEATURES

Adjustable motor mounts

Auger pulleys are standard

The intake flighting is protected by an intake guard

OPTIONS

Poly hopper / Flow control

FARM KING MANUFACTURES A WIDE SELECTION OF UTILITY AUGERS, IN TUBE WIDTHS RANGING FROM 4" TO 8", AND IN LENGTHS OF 11' TO 23'.

Various tubing lengths are available for a variety of applications. The components are adaptable to suit various configuration and capacity requirements, and solid construction and heavy gauge tubing ensures extra durability and longevity.

CAGE

A spider cage protects the intake flighting and belt guards are standard on all augers.

FLOW CONTROL

An optional flow control set up is available to control the rate the auger is receiving product.

SPECIFICATIONS

MODEL >>	4"	6"	8"
Auger lengths	11' / 16' / 21'	11' / 16' / 21'	11** / 16' / 23**
Extension lengths	10'	10'	5', 10'
Power	½ - 1 hp	1 - 4 hp	3 - 10 hp
Auger tubing	16 gauge	16 gauge	14 gauge
Flighting	12 gauge	12 gauge	10 gauge

* Non-extendable

Motor Mounts - Standard adjustable motor mounts mean that Farm King utility augers can be paired with various sizes and brands of electrical motors.

Extensions - Heavy-duty flange and square coupler connect these tubing extensions.



[1] Hopper [2] Hydraulic drive with variable speed control [3] Electric-drive models have an adjustable motor mount



UNLOADING AUGER

10" MODELS

UNLOADING AUGER

PRODUCT OVERVIEW

Transfers grain and oilseed faster

Handheld maneuverability

Reaches where normal portable augers can't

FEATURES

Rubber edging on hopper to minimize spillage

Even weight distribution

OPTIONS

Hydraulic drive and electric drive available

FARM KING UNLOADING AUGERS TRANSFER GRAINS AND OILSEEDS MUCH FASTER THAN CONVENTIONAL UTILITY AUGERS AND REACH WHERE NORMAL PORTABLE AUGERS CAN'T.

The hopper of the unloading auger fits under hopper bottom bins and hopper trailers for fast and easy unloading. The weight is evenly distributed at the pivot wheels for optimum stability and balance; one person can easily move the unloading auger into position.

SPECIFICATIONS

MODEL >>	1010H	1010E
Tube width	10"	10"
Tube length	9'	9'
Drive type	Hydraulic	Electric
Hydraulic requirements	12 gpm, 1200-1400 PSI	-
Motor requirements	-	3 to 5 hp, 1725 RPM
Auger tubing	16 gauge	16 gauge
Flighting (Measured from centre of strip)	12 gauge	12 gauge
Capacity range*	3500-4500 BPH	
Weight	310 lb	320 lb

* Varies based on crop variety, moisture and density

DRIVE	A (up)	A (down)	B (up)	B (down)	C (up)	C (down)	D (up)	D (down)	E
Hydraulic	44"	38"	65"	64"	149"	151"	15.5"	13.25"	12.5"
Electric motor	42"	35.5"	52"	52"	149"	151"	15.5"	13.25"	12.5"

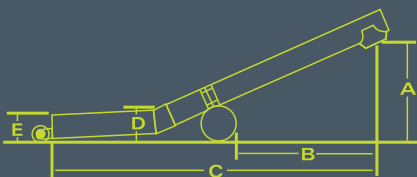

GRAIN CLEANER

PRODUCT OVERVIEW

Separates the heavy dockage from grain before shipping / storing

Cleans up to 700 bu/hr with the model 362 and up to 1900 bu/hr with model 482

FEATURES

Two-stage screening process

Larger intake spouts for easy filling

OPTIONS

Intake auger

Model 482

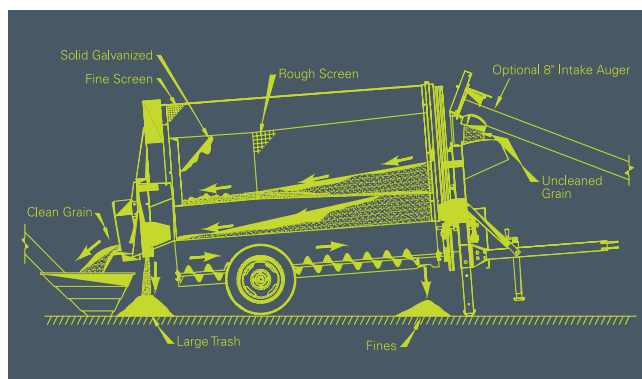

GRAIN CLEANER

MODELS 362 AND 482

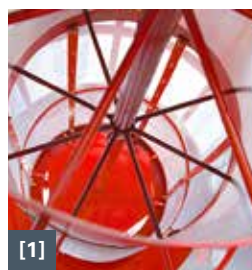

[1] Cleaning Process [2] Move Trash

CLEANING PROCESS

A two-stage screening process includes an inner cone screen for large trash and an outer drum screen for fines. A large unloading chute located at the back of the grain cleaner transports the cleaned seed out of the drums and into the auger hopper.

MOVE TRASH

The 482 model comes standard with a trash pan and fines auger. Trash fines are collected in the pan and moved to an outlet port on the front side of the machine. This system makes for easy clean up.

PRECISE PLACEMENT

The utility auger slide bar allows the optional intake auger to be placed in transport mode or positioned directly over the intake spout. A 6" intake auger is available for the 362 model and an 8" is available for the 482 model.

SPECIFICATIONS

MODEL >>	362	482
Drum diameter / length	36" / 73"	48" / 98"
Total length	97"	144"
Width (outside of tires)	55"	76"
Motor required (approx.)	1 hp	3 hp
Drive	Belt	Belt
Capacity	700 bu/hr	1900 bu/hr
Weight	493 lb	1253 lb
Intake auger (optional)	6"	8"

FARM KING BUILDS TWO GRAIN CLEANER MODELS THAT ARE DESIGNED TO SEPARATE THE HEAVY DOCKAGE FROM GRAIN WITH A TWO-STAGE SCREENING SYSTEM BEFORE IT GETS SHIPPED OR STORED, INCREASING PROFIT.

- ☑ **Dockage reduces bin storage capacity and increases shipping costs.**
- ☑ **Cleaned grain dries faster.**
- ☑ **Screenings can be used as animal feed.**

Model 362

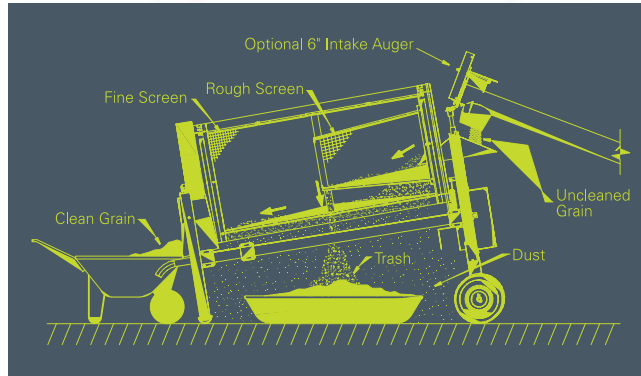

[3] Transport [4] Unload Clean Grain [5] Precise Placement Utility Auger On Both Models

The Model 362 can clean up to 700 bushels per hour. The screenings are discharged onto the ground while cleaned grain is distributed through a built-in chute for convenient loading. The pulleys and adjustable mounts and are designed to fit most 1 hp motors. An optional 6" intake auger for easy loading.

The Model 482 cleans up to 1900 bushels per hour, depending on moisture content and the amount of dockage. Trash and fines are thoroughly removed from the grain, with the fines being separated from larger screenings and are unloaded from separate chutes. An optional trash pan is available for collecting screenings.

SCREENS >>	INNER CONE (standard)	INNER CONE (large/small)	OUTSIDE DRUM (standard)	OUTSIDE DRUM (large/small)
Corn	5/8 x 5/8 x 17 ga.	Small - 2 x 2 x 19 ga.	4 x 4 x 23 ga.	-
Wheat	4 x 4 x 23 ga.	Large - 3 x 3 x 21 ga.	8 x 8 x 27 ga.	Large - 6 x 6 x 25 ga.
Sunflower	2 x 2 x 19 ga.	Large - 5/8 x 5/8 x 17 ga.	6 x 6 x 25 ga.	Small - 8 x 8 x 27 ga. Large - 5 x 5 x 24 ga.
Soybean	2 x 2 x 19 ga.	Small - 3 x 3 x 21 ga.	5 x 5 x 24 ga.	Small - 6 x 6 x 25 ga.
Milo	4 x 4 x 23 ga.	Small - 5 x 5 x 24 ga. Large - 3 x 3 x 21 ga.	8 x 8 x 27 ga.	Large - 6 x 6 x 25
Flax	4 x 4 x 23 ga.	Small - 5 x 5 x 24 ga.	10 x 10 x 29 ga.	-

GRAIN CLEANER

SAMPLE SCREEN HOLE SIZES

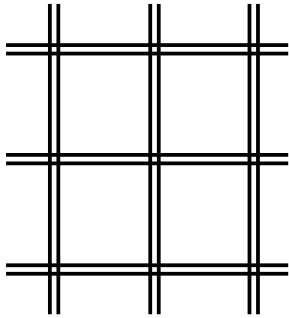

5/8 x 5/8 x 17 Ga

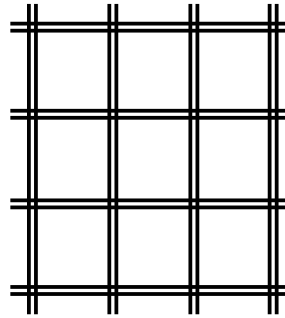

2 x 2 x 19 Ga

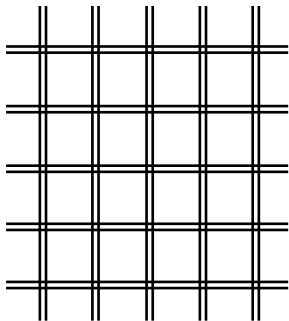

3 x 3 x 21 Ga

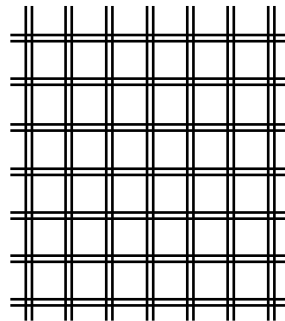

4 x 4 x 23 Ga

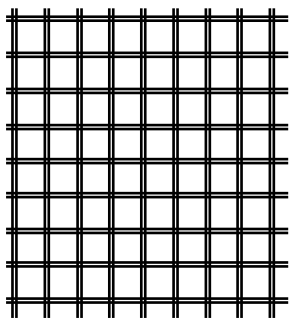

5 x 5 x 24 Ga

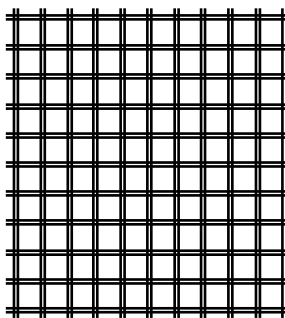

6 x 6 x 25 Ga

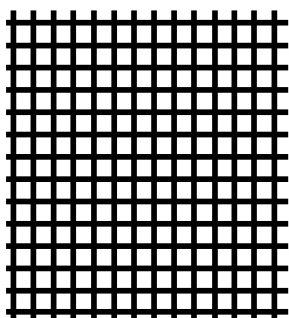

8 x 8 x 27 Ga

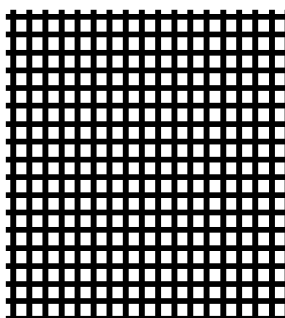

10 x 10 x 29 Ga



ROLLER MILL & HAMMER MILL

ROLLER MILL / HAMMER MILL

PRODUCT OVERVIEW

Roller Mill is capable of processing up to 300 bushels per hour

Hammer Mill is capable of processing up to 75 bushels per hour

OPTIONS

Optional magnet removes nails and other metal objects from the grain

15" wheels and a 12' hydraulic discharge auger available on the model 180

ROLLER MILLS AND HAMMER MILLS ARE DESIGNED TO MAXIMIZE THE NUTRITIONAL VALUE OF FEED.

Available in three sizes, Farm King Roller Mills are capable of processing up to 300 bushels per hour. A manual feed gate sets the flow into the Roller Mill and the adjustable tensioner determines the thickness of finished grain. Double leaf springs ensure constant, even roller pressure.

The Farm King Hammer Mill delivers top quality processed grain, up to 75 bushels per hour, with minimum maintenance and low operating costs.

ROLLER MILL	85	100	180
Size	7" x 8"	10" x 10"	18" x 10"
Roll diameter	8"	10"	10"
Grooves per inch	8 (6 corn)	8 (6 corn)	8 (6 corn)
Roll pressure	Double leaf spring		
Capacity (approx.)	50-100 bu/hr	100-150 bu/hr	200-300 bu/hr
Magnet	Optional	Optional	Optional
Drive required	PTO or 3-5 hp electric	PTO or 5-7.5 hp electric	40-60 PTO hp
Discharge auger	Not available	Not available	Optional
Tires	Not available	Not available	Optional
Stationary stand	Optional	Optional	Optional
Weight	225 lb	317 lb	540 lb
Scrapers	Optional	Optional	Standard

HAMMER MILL	60
Working width	6"
Drive	Double-V pulley
Motor required (approx.)	5 - 7.5 hp, 3450 rpm motor (not included)
Capacity (approx.)	75 bu/hr
Hammers	18, C1045 carbon steel
Rows	6
Screen size	6" wide x 14" round
Height	36" (including hopper)
Width	24"
Depth	19"
Weight	145 lb

farm-king.com



Farm King

For more information contact:

E-mail: info@buhler.com

farm-king.com

Equipment shown is subject to change without notice. ©2020 Buhler Trading Inc.
Printed in Canada. TSX:BUI Ref: 042020

bühler | a division of Buhler Industries Inc.