

**Robex**

# 25z-9A

With Tier 4 Interim Engine installed

MOVING YOU FURTHER

**HYUNDAI HEAVY INDUSTRIES**



**HYUNDAI**  
CONSTRUCTION EQUIPMENT AMERICAS, INC.

\*Photo may include optional equipment



# PRIDE AT WORK

Hyundai Heavy Industries strives to build state-of-the-art earthmoving equipment to give every operator maximum performance, more precision, versatile machine preferences, and proven quality.

***Moving you further !***



\*Photo may include optional equipment.



# Robex 25Z-9A

---

## Machine Walk-Around

---

### Engine Technology

Proven, reliable, fuel efficient, low emission and low noise  
Mitsubishi Tier 4 interim

### Rugged Upper and Lower Frame

The upper frame is designed to be heavy duty to absorb high stress load on the job. X-leg center frame and reinforced box section track frame provide exceptional strength and longer service life to withstand tough working conditions.

### Efficient Control System

Control devices are all conveniently located for improved operator comfort and productivity. A safety lever on the left-side console is designed to prevent exiting the cabin while hydraulic controls are live.

### Advanced Hydraulic System

The R25Z-9A hydraulic system is precision designed for fast operation with fine control capabilities.

### Comfortable and Durable Cabin

The cabin is roomy and ergonomically designed, with reduced sound levels and good visibility. Both canopy and cabin style frames meet international standards TOPS, ROPS, FOPS ensuring operator's safety.

### Operator Convenience

The R25Z-9A features a suspension seat, foldable pedals for added space and multiple storage compartments.

The monitoring system includes seven warning indicators, water temperature gauge, fuel gauge and hour meter for productive, convenient operating.

### Easy and Simple Maintenance

An adjustable suspension seat, wrist rests, ergonomically designed joysticks and plenty of leg room help to reduce operator fatigue. An array of indicators and gauges are displayed on the monitor which keep the operator aware of machine performance at all times. The monitoring system includes seven warning indicators, water temperature gauge, fuel gauge and hour meter.

### Extended Life of Components

The R25Z-9A reduces operating costs over time with long life hydraulic filters, hydraulic oil, shims and bushings.



# PRECISION

Innovative hydraulic system technologies make the 9A series excavator fast, smooth and easy to control.



\*Photo may include optional equipment.



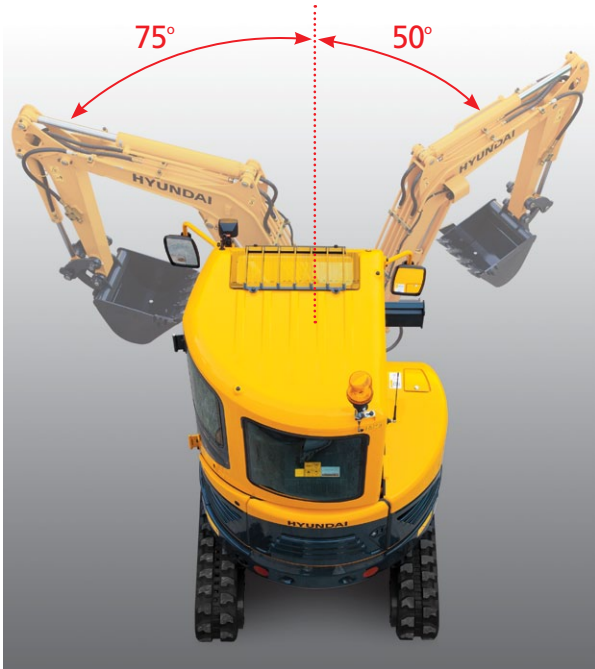

## Boom Swing

The R25Z-9A's boom swing function is designed for efficient work in congested residential and urban areas. The boom can be offset left or right within an operating range.



## Easy to transport

The new R25Z-9A can be moved on a small trailer, with a simple car driver's licence. No truck is required to easily transport the machine to a jobsite, and back to the yard.



## Dozer Blade

Large dozer blade provides added versatility, work efficiency and stability for the job.



## Zero-tail Swing

R25Z-9A's short tail swing radius allows the operator work in confined areas like close to buildings on roadways, and in urban areas. This compact radius design provides easy and efficient operation in any limited space work environment.

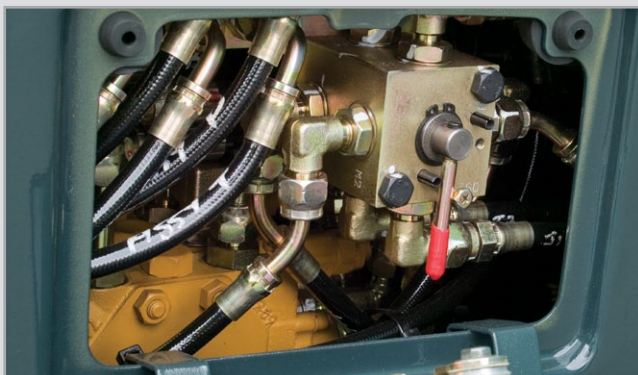

## Lever Pattern Change Valve

Joystick control patterns can be changed through an optional pattern change valve positioned for easy access.

# PERFORMANCE

9A series is designed for maximum performance to keep the operator working productively.



\*Photo may include optional equipment.



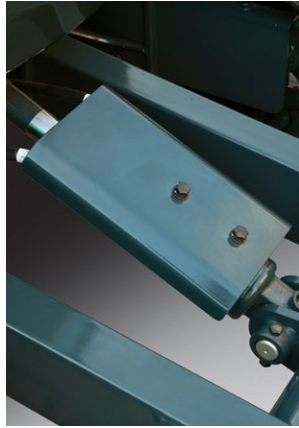

## Cylinder Covers

Standard boom and dozer cylinder covers provide added protection.

## Structure Strength

The R25Z-9A cabin structure has been fitted with stronger but slimmer tubing for added safety and improved visibility. Low-stress, high strength steel is integrally welded to form a stronger, more durable upper and lower frame. Structural integrity was tested by way of FEM (Finite Elements Method) analysis and long-term durability tests.

## Mitsubishi S3L2

Tier 4 certified, Mitsubishi S3L2 engine provides maximum power, reliability, optimum fuel economy, and reduced emissions.

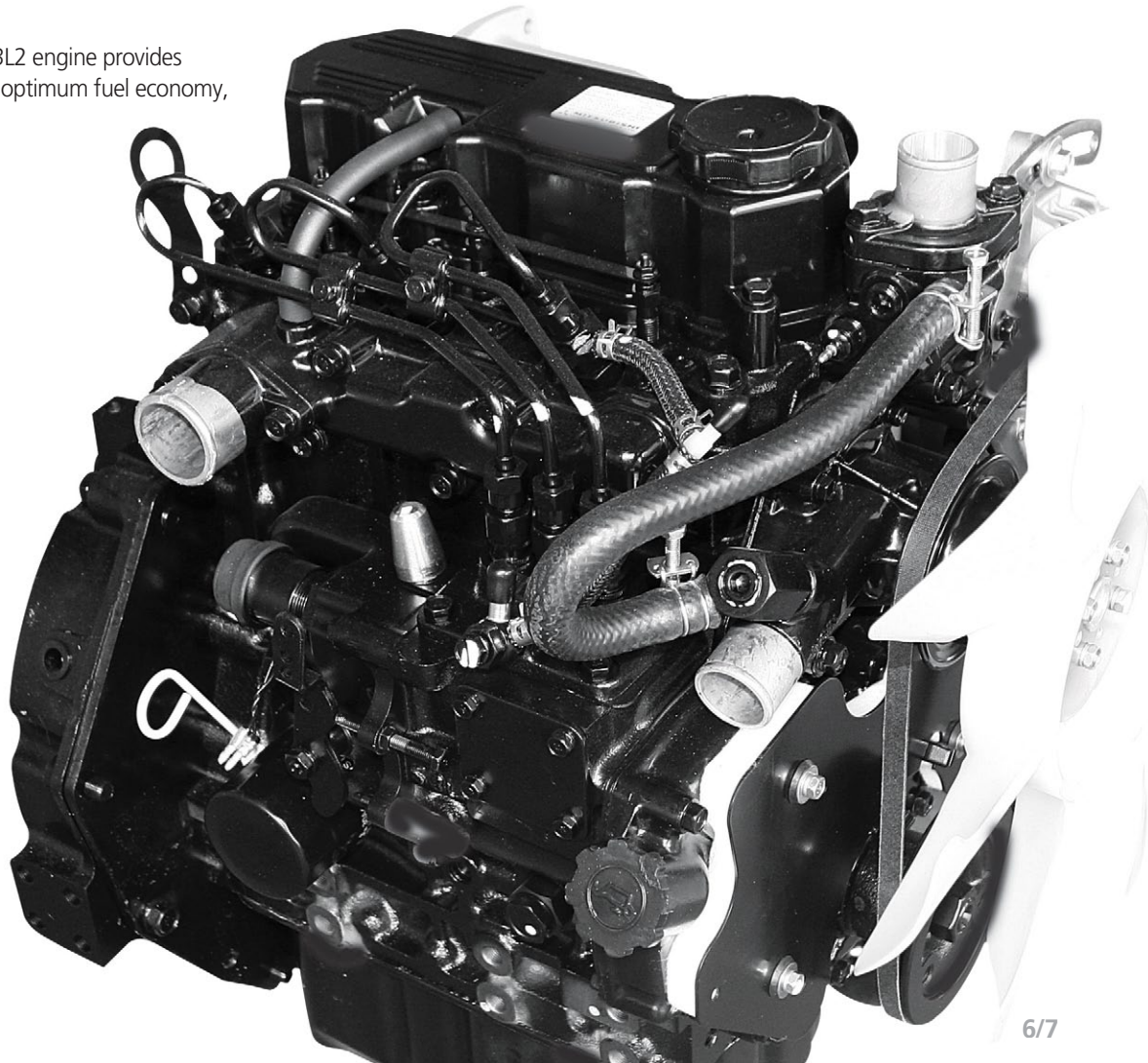



# PREFERENCE

Operating a 9A series is unique to every operator. Operators can fully customize their work environment and operating preferences to fit their individual needs.



\*Photo may include optional equipment.



## Monitor

The monitoring system of the R25Z-9A provides the operator with machine status information, including: engine oil pressure, battery charge, engine coolant temperature and a fuel gauge.



## Comfortable Operating Cabin

In a 9A series cabin, you can easily adjust the seat and wrist rests settings to best suit your preferred operating condition.

1. All pedals are foldable for additional floor space. Foot rest, attachment pedal, left and right travel pedals and boom swing pedal are arranged for convenient access.
2. Two cup holders are integrated into the right console for large and small drink storage.
3. An additional storage box with key lock is accessible under the operator's seat.
4. Adjustable wrist rests provide additional comfort.
5. A sliding fold-in front window is easily opened and safely stored in an open position to improve ventilation and visibility.(Cabin type only)

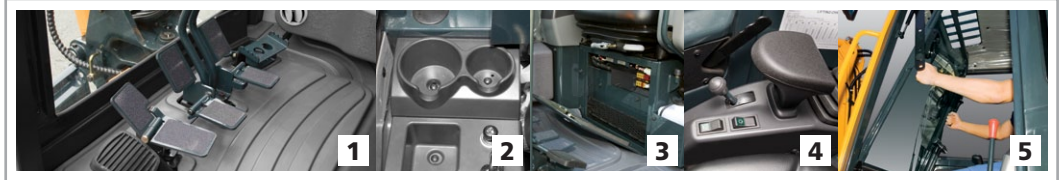

## Reduced Stress

An operator's work environment should be stress free. Hyundai's R25Z-9A compact excavator is designed for comfort, reduced sound and plenty of space to reduce stress on the operator.

## Operator Comfort

The left and right control levers are ergonomically located for convenient access. A safety lock system is designed to prevent exiting the cabin while hydraulic controls are live. When the safety lever and left side console are positioned upright, hydraulic functions are disengaged.



A tiltable left-side console makes it easier for the operator to enter and exit the cab.



# PROFITABILITY

9A series is designed to maximize profitability through improved efficiencies, enhanced service features and longer life components.



\*Photo may include optional equipment.





## Easy Change Air Cleaner

The R25Z-9A is equipped with a durable plastic air cleaner designed for easy maintenance.



## Centralized Grease Fittings

A centralized lubrication bank is available for faster, easier service and maintenance.



## Double Acting Pipe Selector

Double Acting Pipe located on front of the Fuel Tank for easy to access and control.



## Easy Access

The R25Z-9A was built with accessibility in mind. All doors, covers and hoods were built for complete open access. Regular service and maintenance is easy and convenient with the R25Z-9A.



## Long-Life Components

9A series excavators were designed with bushings designed for long-life lube intervals (250 hrs) & polymer shims (wear resistant, noise reducing), long-life hydraulic filters (1,000hrs), long-life hydraulic oil (5,000hrs), more efficient cooling systems and integrated preheating systems which extend service intervals, minimize operating costs and reduce machine down time.

# Specifications

## ENGINE

|                            |                                       |                               |  |
|----------------------------|---------------------------------------|-------------------------------|--|
| Model                      | Mitsubishi S3L2                       |                               |  |
| Type                       | 4 Cycle. In line, water cooled Diesel |                               |  |
| Rated flywheel horse power |                                       |                               |  |
| SAE                        | J1995 (gross)                         | 24.7 HP ( 18.4kW) at 2,300rpm |  |
|                            | J1349 (net)                           | 23.1 HP ( 17.2kW) at 2,300rpm |  |
| DIN                        | 627 1/1 (gross)                       | 25.0 PS ( 18.4kW) at 2,300rpm |  |
|                            | 627 1/1 (net)                         | 23.4 PS ( 17.2kW) at 2,300rpm |  |
| Max. torque                | 8.0 kgf·m(58 lbf·ft) at 1,800 rpm     |                               |  |
| Bore x stroke              | 78mm x 92mm (3.07" x 3.62")           |                               |  |
| Piston displacement        | 1,318cc (80.4 in <sup>3</sup> )       |                               |  |
| Batteries                  | 12V - 80AH                            |                               |  |
| Starting motor             | 12V - 1.7kW                           |                               |  |
| Alternator                 | 12V - 40A                             |                               |  |

## HYDRAULIC SYSTEM

|                            |   |
|----------------------------|---|
| Main pumps                 |   |
| Type                       | variable displacement piston pumps  |
| Rated flow                 | 2 x 27.6 + 19.6 L/min   |
| Sub-pump for pilot circuit | Gear pump   |
| Hydraulic motors           |   |
| Travel                     | Two speed axial piston motor with counter balance valve and parking brake |
| Swing                      | Axial piston motor with automatic brake                                   |
| Relief valve setting       |   |
| Implement circuits         | 220 Kg/cm <sup>2</sup> (3,130 psi)  |
| Travel circuit             | 220 Kg/cm <sup>2</sup> (3,130 psi)  |
| Swing circuit              | 170 Kg/cm <sup>2</sup> (2,420 psi)  |
| Pilot circuit              | 30 Kg/cm <sup>2</sup> (430 psi)   |
| Service valve              | Installed   |

## HYDRAULIC CYLINDER

|                                 |                            |
|---------------------------------|----------------------------|
| No. of cylinder - bore x stroke |                            |
| Boom                            | 75 x 565 mm (3.0" x 22.2") |
| Arm                             | 70 x 500 mm (2.8" x 19.7") |
| Bucket                          | 60 X 420 mm (2.4" x 16.5") |
| Boom swing                      | 75 X 400 mm (3.0" x 15.7") |
| Dozer blade                     | 85 X 140 mm (3.3" x 5.5")  |

## NOISE LEVEL(CAB)

|                              |      |
|------------------------------|------|
| Noise Levels (dynamic value) |      |
| LwA                          | 94dB |
| LpA                          | 75dB |

## COOLANT & LUBRICANT CAPACITY

|                |       |        |        |
|----------------|-------|--------|--------|
| (refilling)    | liter | US gal | UK gal |
| Fuel tank      | 25    | 6.6    | 5.5    |
| Engine coolant | 4.2   | 1.1    | 0.9    |
| Engine oil     | 5.9   | 1.6    | 1.3    |
| Hydraulic tank | 27    | 7.1    | 5.9    |

## TRAVEL LEVERS

Traveling and steering : Two levers with pedals.

## CONTROL LEVERS

|                 |  |
|-----------------|--|
| Type            |  |
| Pilot control   | Two joysticks with one safety lever (LH): Swing and arm, (RH): Boom and bucket with horn (ISO) |
| Engine throttle | Mechanical, cable type   |

## SWING SYSTEM

|                           |                          |
|---------------------------|--------------------------|
| Swing motor               | Axial piston motor       |
| Swing reduction           | Planetary gear reduction |
| Swing circuit lubrication | Grease - bathed          |
| Swing brake               | Wet disc                 |
| Swing speed               | 9.1 rpm                  |

## DRIVES & BRAKES

|                                 |                                   |
|---------------------------------|-----------------------------------|
| Max. travel speed(high) / (low) | 4.5km / 2.5km (2.8mph) / (1.6mph) |
| Maximum traction force          | 2.4ton                            |
| Maximum gradeability            | 30°                               |
| Parking brake                   | Wet disc                          |

## DIGGING FORCE(ISO)

|                |                   |
|----------------|-------------------|
| Bucket         | 2,150 kgf         |
|                | 21.1 kN           |
| Arm [Long Arm] | 4,740 lbf         |
|                | 1,490 [1,310] kgf |
|                | 14.6 [12.8] kN    |
|                | 3,280 [2,890] lbf |

## WEIGHT(APPROXIMATE)

Operating weight, including 1,945 mm (6' 5") boom, 1,120 mm (3' 8") arm, SAE heaped 0.07 m<sup>3</sup> (0.1 yd<sup>3</sup>) excavator bucket, lubricant, coolant, full fuel tank, hydraulic tank and the standard equipment.

|                  |                          |                                     |
|------------------|--------------------------|-------------------------------------|
| Shoe Width       | Rubber shoe 250 mm (10") |                                     |
| Operating Weight | Cabin                    | 2,600 Kg (5,730lb)                  |
|                  | Canopy                   | 2,450 Kg (5,400lb)                  |
| Ground Pressure  | Cabin                    | 0.33 kg / cm <sup>2</sup> (4.69psi) |
|                  | Canopy                   | 0.31 kg / cm <sup>2</sup> (4.41psi) |

## UNDERCARRIAGE

X-leg type center frame is integrally welded with reinforced box-section track frames. The undercarriage includes lubricated rollers, track adjusters with shock absorbing springs and sprockets, and rubber shoes.

|                                    |                     |
|------------------------------------|---------------------|
| Center frame                       | X-leg type          |
| Track frame                        | Pentagonal box type |
| No. of carrier roller on each side | 1                   |
| No. of track roller on each side   | 3                   |



# Dimensions & Working Range

## R25Z-9A DIMENSIONS

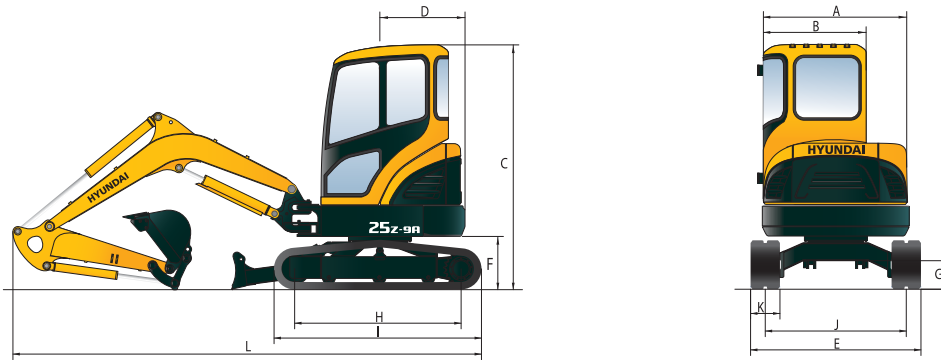

mm (ft-in)

|   |                                  |                |   |                  |                |
|---|----------------------------------|----------------|---|------------------|----------------|
| A | Overall width of upper structure | 1,485 (4' 10") | G | Ground clearance | 290 (11")      |
| B | Overall width of cab             | 1,050 (3' 5")  | H | Tumbler distance | 1,490 (4' 11") |
| C | Overall height of cab            | 2,500 (8' 2")  | I | Track length     | 1,910 (6' 3")  |
| D | Tail swing radius                | 775 (2' 7")    | J | Track gauge      | 1,250 (4' 1")  |
|   | With additional counterweight    | 875 (2' 10")   | K | Track shoe width | 250 (10")      |
| E | Overall width                    | 1,500 (4' 11") | L | Overall length   | 4,030 (13' 3") |
| F | Clearance under counterweight    | 540 (1' 9")    |   | Long Arm         | 4,100 (13' 5") |

## R25Z-9A WORKING RANGE

mm (ft-in)

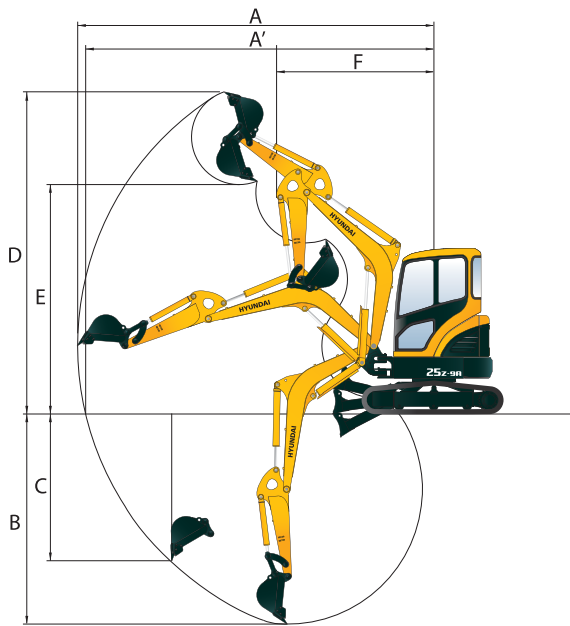

|    |                                  |                                    |
|----|----------------------------------|------------------------------------|
|    | Boom length                      | 1,945 (6' 5")                      |
|    | Arm length                       | 1,120 (3' 8")<br>*1,350 (4' 5")    |
| A  | Max. digging reach               | 4,480 (14' 8")<br>*4,680 (15' 4")  |
| A' | Max. digging reach at ground     | 4,340 (14' 3")<br>*4,540 (14' 11") |
| B  | Max. digging depth               | 2,420 (7' 11")<br>*2,645 (8' 8")   |
| C  | Max. vertical wall digging depth | 1,460 (4' 9")<br>*1,605 (5' 3")    |
| D  | Max. digging height              | 4,150 (13' 7")<br>*4,235 (13' 11") |
| E  | Max. dumping height              | 2,930 (9' 7")<br>*3,030 (9' 11")   |
| F  | Min. swing radius                | 1,980 (6' 6")<br>*1,970 (6' 6")    |











\* Long Arm

# Lifting capacity











## R25Z-9A



Boom : 1.945 m (6' 5") / Arm : 1.12 m (3' 8") / Bucket : 0.07 m<sup>3</sup> SAE heaped / Dozer Down : 250mm(9.8") Rubber track Cabin Type W/O ADD CWT

| Load point height<br>m(ft) |    | Load radius   |   |   |   |   |   |  |   | At max. reach   |   |                    |
|----------------------------|----|---|---|---|---|---|---|--|---|---|---|--------------------|
|                            |    | 2.0 m(5 ft)   |   | 2.5 m(10 ft)  |   | 3.0 m(10 ft)  |   | 3.5 m(10 ft)   |   | Capacity  |   | Reach<br>m<br>(ft) |
|                            |    |  |  |  |  |  |  |  |  |  |  |                    |
| 3.5 m                      | kg |   |   |   |   |   |   |  |   | *550  | 400   | 2.88               |
| 10 ft                      | lb |   |   |   |   |   |   |  |   | *1210   | 880   | (9.4)              |
| 3.0 m                      | kg |   |   |   |   | *660  | 360   |  |   | *570  | 290   | 3.48               |
| 10 ft                      | lb |   |   |   |   | *1460   | 790   |  |   | *1260   | 640   | (11.4)             |
| 2.5 m                      | kg |   |   |   |   | *640  | 360   |  |   | *580  | 240   | 3.85               |
| 10 ft                      | lb |   |   |   |   | *1410   | 790   |  |   | *1280   | 530   | (12.6)             |
| 2.0 m                      | kg |   |   | *740  | 490   | *700  | 360   | *680   | 270   | *600  | 210   | 4.09               |
| 5 ft                       | lb |   |   | *1630   | 1080  | *1540   | 790   | *1500  | 600   | *1320   | 460   | (13.4)             |
| 1.5 m                      | kg | *1360   | 680   | *970  | 470   | *810  | 350   | *730   | 260   | *620  | 190   | 4.22               |
| 5 ft                       | lb | *3000   | 1500  | *2140   | 1040  | *1790   | 770   | *1610  | 570   | *1370   | 420   | (13.8)             |
| 1.0 m                      | kg |   |   | *1220   | 450   | *940  | 340   | *790   | 260   | *630  | 190   | 4.26               |
| 5 ft                       | lb |   |   | *2690   | 990   | *2070   | 750   | *1740  | 570   | *1390   | 420   | (14.0)             |
| 0.5 m                      | kg | *1310   | 610   | *1380   | 430   | *1040   | 330   | *840   | 250   | *650  | 190   | 4.22               |
| 0 ft                       | lb | *2890   | 1340  | *3040   | 950   | *2290   | 730   | *1850  | 550   | *1430   | 420   | (13.8)             |
| Ground                     | kg | *1760   | 600   | *1450   | 430   | *1080   | 320   | *860   | 250   | *670  | 190   | 4.09               |
| Line                       | lb | *3880   | 1320  | *3200   | 950   | *2380   | 710   | *1900  | 550   | *1480   | 420   | (13.4)             |
| -0.5 m                     | kg | *1990   | 610   | *1410   | 420   | *1050   | 320   |  |   | *690  | 210   | 3.86               |
| -0 ft                      | lb | *4390   | 1340  | *3110   | 930   | *2310   | 710   |  |   | *1520   | 460   | (12.7)             |
| -1.0 m                     | kg | *1740   | 610   | *1250   | 430   | *900  | 320   |  |   | *690  | 250   | 3.49               |
| -5 ft                      | lb | *3840   | 1340  | *2760   | 950   | *1980   | 710   |  |   | *1520   | 550   | (11.5)             |
| -1.5 m                     | kg | *1250   | 630   | *840  | 440   |   |   |  |   | *650  | 350   | 2.90               |
| -5 ft                      | lb | *2760   | 1390  | *1850   | 970   |   |   |  |   | *1430   | 770   | (9.5)              |
| -2.5 m                     | kg |   |   |   |   |   |   |  |   | *490  | 330   | 3.14               |
| -10 ft                     | lb |   |   |   |   |   |   |  |   | *1080   | 730   | (10.3)             |

Boom : 1.945 m (6' 5") / Arm : 1.12 m (3' 8") / Bucket : 0.07 m<sup>3</sup> SAE heaped / Dozer up : 250mm(9.8") rubber track . Cabin Type . W/O ADD CWT

| Load point height<br>m(ft) |    | Load radius   |   |   |   |   |   |  |   | At max. reach   |   |                    |
|----------------------------|----|---|---|---|---|---|---|--|---|---|---|--------------------|
|                            |    | 2.0 m(5 ft)   |   | 2.5 m(10 ft)  |   | 3.0 m(10 ft)  |   | 3.5 m(10 ft)   |   | Capacity  |   | Reach<br>m<br>(ft) |
|                            |    |  |  |  |  |  |  |  |  |  |  |                    |
| 3.5 m                      | kg |   |   |   |   |   |   |  |   | 460   | 400   | 2.88               |
| 10 ft                      | lb |   |   |   |   |   |   |  |   | 1010  | 880   | (9.4)              |
| 3.0 m                      | kg |   |   |   |   | 410   | 360   |  |   | 330   | 290   | 3.48               |
| 10 ft                      | lb |   |   |   |   | 900   | 790   |  |   | 730   | 640   | (11.4)             |
| 2.5 m                      | kg |   |   |   |   | 410   | 360   |  |   | 270   | 240   | 3.85               |
| 10 ft                      | lb |   |   |   |   | 900   | 790   |  |   | 600   | 530   | (12.6)             |
| 2.0 m                      | kg |   |   | 560   | 490   | 410   | 360   | 310  | 270   | 240   | 210   | 4.09               |
| 5 ft                       | lb |   |   | 1230  | 1080  | 900   | 790   | 680  | 600   | 530   | 460   | (13.4)             |
| 1.5 m                      | kg | 800   | 680   | 540   | 470   | 400   | 350   | 300  | 260   | 220   | 190   | 4.22               |
| 5 ft                       | lb | 1760  | 1500  | 1190  | 1040  | 880   | 770   | 660  | 570   | 490   | 420   | (13.8)             |
| 1.0 m                      | kg |   |   | 520   | 450   | 380   | 340   | 290  | 260   | 210   | 190   | 4.26               |
| 5 ft                       | lb |   |   | 1150  | 990   | 840   | 750   | 640  | 570   | 460   | 420   | (14.0)             |
| 0.5 m                      | kg | 730   | 610   | 500   | 430   | 370   | 330   | 290  | 250   | 210   | 190   | 4.22               |
| 0 ft                       | lb | 1610  | 1340  | 1100  | 950   | 820   | 730   | 640  | 550   | 460   | 420   | (13.8)             |
| Ground                     | kg | 720   | 600   | 490   | 420   | 370   | 320   | 290  | 250   | 220   | 190   | 4.09               |
| Line                       | lb | 1590  | 1320  | 1080  | 930   | 820   | 710   | 640  | 550   | 490   | 420   | (13.4)             |
| -0.5 m                     | kg | 720   | 610   | 490   | 420   | 370   | 320   |  |   | 240   | 210   | 3.86               |
| -0 ft                      | lb | 1590  | 1340  | 1080  | 930   | 820   | 710   |  |   | 530   | 460   | (12.7)             |
| -1.0 m                     | kg | 730   | 610   | 500   | 430   | 370   | 320   |  |   | 290   | 250   | 3.49               |
| -5 ft                      | lb | 1610  | 1340  | 1100  | 950   | 820   | 710   |  |   | 640   | 550   | (11.5)             |
| -1.5 m                     | kg | 750   | 630   | 510   | 440   |   |   |  |   | 440   | 350   | 2.90               |
| -5 ft                      | lb | 1650  | 1390  | 1120  | 970   |   |   |  |   | 880   | 770   | (9.5)              |
| -2.5 m                     | kg |   |   |   |   |   |   |  |   | 370   | 330   | 3.14               |
| -10 ft                     | lb |   |   |   |   |   |   |  |   | 820   | 730   | (10.3)             |

- Lifting capacity is based on SAE J1097, ISO 10567.
- Lifting capacity of the Robex Series does not exceed 75% of the tipping load with the machine on firm, level ground or 87% of full hydraulic capacity.
- The load point is a hook located (standard equipment) on the back of the bucket.
- (\*) indicates the load limited by hydraulic capacity.



# Lifting capacity



Boom : 1.945 m (6' 5") / Arm : 1.35 m (4' 5") / Bucket : 0.07 m<sup>3</sup> SAE heaped / Dozer Down : 250mm(9.8") rubber track. Cabin Type. W/O ADD CWT

| Load point height<br>m(ft) |    | Load radius |      |              |      |              |     |              |     |              |     | At max. reach |     |        |
|----------------------------|----|-------------|------|--------------|------|--------------|-----|--------------|-----|--------------|-----|---------------|-----|--------|
|                            |    | 2.0 m(5 ft) |      | 2.5 m(10 ft) |      | 3.0 m(10 ft) |     | 3.5 m(10 ft) |     | 4.0 m(15 ft) |     | Capacity      |     | Reach  |
|                            |    |             |      |              |      |              |     |              |     |              |     |               |     | m (ft) |
| 3.5 m                      | kg |             |      |              |      |              |     |              |     |              |     | *490          | 330 | 3.22   |
| 10 ft                      | lb |             |      |              |      |              |     |              |     |              |     | *1080         | 730 | (10.6) |
| 3.0 m                      | kg |             |      |              |      | *530         | 360 |              |     |              |     | *510          | 250 | 3.74   |
| 10 ft                      | lb |             |      |              |      | *1170        | 790 |              |     |              |     | *1120         | 550 | (12.3) |
| 2.5 m                      | kg |             |      |              |      | *530         | 370 | *580         | 270 |              |     | *530          | 210 | 4.07   |
| 10 ft                      | lb |             |      |              |      | *1170        | 820 | *1280        | 600 |              |     | *1170         | 460 | (13.4) |
| 2.0 m                      | kg |             |      |              |      | *610         | 360 | *610         | 270 |              |     | *540          | 190 | 4.29   |
| 5 ft                       | lb |             |      |              |      | *1340        | 790 | *1340        | 600 |              |     | *1190         | 420 | (14.1) |
| 1.5 m                      | kg | *1060       | 700  | *840         | 480  | *730         | 350 | *670         | 260 | *580         | 200 | *560          | 180 | 4.42   |
| 5 ft                       | lb | *2340       | 1540 | *1850        | 1060 | *1610        | 770 | *1480        | 570 | *1280        | 440 | *1230         | 400 | (14.5) |
| 1.0 m                      | kg | *1660       | 650  | *1100        | 450  | *870         | 340 | *740         | 260 | *670         | 200 | *580          | 170 | 4.46   |
| 5 ft                       | lb | *3660       | 1430 | *2430        | 990  | *1920        | 750 | *1630        | 570 | *1480        | 440 | *1280         | 370 | (14.6) |
| 0.5 m                      | kg | *1680       | 610  | *1310        | 430  | *990         | 320 | *810         | 250 | *680         | 200 | *610          | 170 | 4.42   |
| 0 ft                       | lb | *3700       | 1340 | *2890        | 950  | *2180        | 710 | *1790        | 550 | *1500        | 440 | *1340         | 370 | (14.5) |
| Ground                     | kg | *1830       | 600  | *1420        | 420  | *1060        | 320 | *850         | 250 |              |     | *630          | 180 | 4.30   |
| Line                       | lb | *4030       | 1320 | *3130        | 930  | *2340        | 710 | *1870        | 550 |              |     | *1390         | 400 | (14.1) |
| -0.5 m                     | kg | *2080       | 600  | *1430        | 420  | *1070        | 310 | *830         | 240 |              |     | *650          | 190 | 4.08   |
| -0 ft                      | lb | *4590       | 1320 | *3150        | 930  | *2360        | 680 | *1830        | 530 |              |     | *1430         | 420 | (13.4) |
| -1.0 m                     | kg | *1890       | 600  | *1330        | 420  | *990         | 310 |              |     |              |     | *670          | 200 | 3.75   |
| -5 ft                      | lb | *4170       | 1320 | *2930        | 930  | *2180        | 680 |              |     |              |     | *1480         | 490 | (12.3) |
| -1.5 m                     | kg | *1520       | 610  | *1070        | 430  |              |     |              |     |              |     | *670          | 280 | 3.24   |
| -5 ft                      | lb | *3350       | 1340 | *2360        | 950  |              |     |              |     |              |     | *1480         | 620 | (10.6) |

Boom : 1.945 m (6' 5") / Arm : 1.35 m (4' 5") / Bucket : 0.07 m<sup>3</sup> SAE heaped / Dozer Up : 250mm(9.8") rubber track. Cabin Type. W/O ADD CWT

| Load point height<br>m(ft) |    | Load radius |      |             |      |              |     |              |     |              |     | At max. reach |     |        |
|----------------------------|----|-------------|------|-------------|------|--------------|-----|--------------|-----|--------------|-----|---------------|-----|--------|
|                            |    | 2.0 m(7 ft) |      | 2.5 m(8 ft) |      | 3.0 m(10 ft) |     | 3.5 m(11 ft) |     | 4.0 m(13 ft) |     | Capacity      |     | Reach  |
|                            |    |             |      |             |      |              |     |              |     |              |     |               |     | m (ft) |
| 3.5 m                      | kg |             |      |             |      |              |     |              |     |              |     | 380           | 330 | 3.22   |
| 10 ft                      | lb |             |      |             |      |              |     |              |     |              |     | 840           | 730 | (10.6) |
| 3.0 m                      | kg |             |      |             |      | 420          | 360 |              |     |              |     | 290           | 250 | 3.74   |
| 10 ft                      | lb |             |      |             |      | 930          | 790 |              |     |              |     | 640           | 550 | (12.3) |
| 2.5 m                      | kg |             |      |             |      | 420          | 370 | 310          | 270 |              |     | 240           | 210 | 4.07   |
| 10 ft                      | lb |             |      |             |      | 930          | 820 | 680          | 600 |              |     | 530           | 460 | (13.4) |
| 2.0 m                      | kg |             |      |             |      | 410          | 360 | 310          | 270 |              |     | 210           | 190 | 4.29   |
| 5 ft                       | lb |             |      |             |      | 900          | 790 | 680          | 600 |              |     | 460           | 420 | (14.1) |
| 1.5 m                      | kg | 820         | 700  | 550         | 480  | 400          | 350 | 300          | 260 | 230          | 200 | 200           | 170 | 4.42   |
| 5 ft                       | lb | 1810        | 1540 | 1210        | 1060 | 880          | 770 | 660          | 570 | 510          | 440 | 440           | 370 | (14.5) |
| 1.0 m                      | kg | 770         | 650  | 530         | 450  | 390          | 340 | 290          | 260 | 230          | 200 | 190           | 170 | 4.46   |
| 5 ft                       | lb | 1700        | 1430 | 1170        | 990  | 860          | 750 | 640          | 570 | 510          | 440 | 420           | 370 | (14.6) |
| 0.5 m                      | kg | 730         | 610  | 500         | 430  | 370          | 320 | 290          | 250 | 220          | 200 | 190           | 170 | 4.42   |
| 0 ft                       | lb | 1610        | 1340 | 1100        | 950  | 820          | 710 | 640          | 550 | 490          | 440 | 420           | 370 | (14.5) |
| Ground                     | kg | 720         | 600  | 490         | 420  | 360          | 320 | 280          | 250 |              |     | 200           | 180 | 4.30   |
| Line                       | lb | 1590        | 1320 | 1080        | 930  | 790          | 710 | 620          | 550 |              |     | 440           | 400 | (14.1) |
| -0.5 m                     | kg | 710         | 600  | 490         | 420  | 360          | 310 | 280          | 240 |              |     | 220           | 190 | 4.08   |
| -0 ft                      | lb | 1570        | 1320 | 1080        | 930  | 790          | 680 | 620          | 530 |              |     | 490           | 420 | (13.4) |
| -1.0 m                     | kg | 720         | 600  | 490         | 420  | 360          | 310 |              |     |              |     | 250           | 220 | 3.75   |
| -5 ft                      | lb | 1590        | 1320 | 1080        | 930  | 790          | 680 |              |     |              |     | 550           | 490 | (12.3) |
| -1.5 m                     | kg | 730         | 610  | 490         | 430  |              |     |              |     |              |     | 330           | 280 | 3.24   |
| -5 ft                      | lb | 1610        | 1340 | 1080        | 950  |              |     |              |     |              |     | 730           | 620 | (10.6) |

- Lifting capacity is based on SAE J1097, ISO 10567.
- Lifting capacity of the Robex Series does not exceed 75% of the tipping load with the machine on firm, level ground or 87% of full hydraulic capacity.
- The load point is a hook located (standard equipment) on the back of the bucket.
- (\*) indicates the load limited by hydraulic capacity.

## STANDARD EQUIPMENT

|   |                                   |                             |                                  |  |
|---|-----------------------------------|-----------------------------|----------------------------------|--|
| ISO standard cabin                                | ·Sliding side window              | Engine oil pressure         | with seat belt                   | ·Mono boom (1.945 m, 6' 5")            |
| ·Cabin ROPS(ISO 3471)                             | ·Lockable door                    | Engine coolant temperature  | ·Console box tilting system(LH.) | ·Arm (1.12 m, 3' 8")                   |
| FOPS(ISO 3449)                                    | ·Accessory box                    | Preheat                     | ·Two front working lights        | ·Rubber crawler (250mm, 10")           |
| FOG(ISO 10262 Level I)                            | ·Centralized monitoring           | Low battery                 | ·Electric horn                   | ·Single acting piping (Breaker, etc)   |
| TOPS(ISO 12117)                                   | ·Gauges                           | Air cleaner closing         | ·Battery (1 x 12 V x 80 AH)      | ·Double acting piping (Clamshell, etc) |
| ·All-weather steel cab with all-around visibility | ·Fuel level gauge                 | Fuel empty                  | ·Battery master switch           |  |
| ·Safety glass windows                             | ·Engine coolant temperature gauge | ·Door and locks, one key    | ·Automatic swing brake           |  |
| ·Sliding fold-in front window                     | ·Warning                          | ·Radio / USB player         | ·Removable reservoir tank        |  |
|   |                                   | ·Mechanical suspension seat | ·Water separator, fuel line      |  |

## OPTIONAL EQUIPMENT

|                        |                                       |                         |                             |
|------------------------|---------------------------------------|-------------------------|-----------------------------|
| ISO standard canopy    | TOPS(ISO 12117)                       | ·Travel alarm           | ·Heater & Defroster         |
| ·Canopy ROPS(ISO 3471) | ·Beacon lamp                          | ·Quick coupler          | ·Lever pattern change valve |
| FOPS(ISO 3449)         | ·Accumulator, work equipment lowering | ·Tool kit               | ·Additional CWT             |
| FOG(ISO 10262 Level I) |                                       | ·Long Arm (1.35m, 4'5") |                             |

\* Standard and optional equipment may vary. Contact your Hyundai dealer for more information. The machine may vary according to International standards.

\* The photos may include attachments and optional equipment that are not available in your area.

\* Materials and specifications are subject to change without advance notice.

\* All imperial measurements rounded off to the nearest pound or inch.

PLEASE CONTACT



6100 Atlantic Blvd, Norcross, GA 30071  
TEL (678) 823-7777 FAX (678) 823-7778