

# BRAUD COMPACT SERIES GRAPE HARVESTERS

7030M | 8030L







# Braud Compact Series. A new dimension for intelligent grape harvesting.

---

The new BRAUD 7030M and 8030L models are built around the proven BRAUD design and deliver the best harvesting quality and productivity. The SDC shaking system with flexible rear rod fixation and quick front engagement softly shakes and detaches the grapes. The NORIA basket system offers the best respect for the vine and harvested crop. These proven BRAUD innovations are now designed around a compact chassis, and combined with the best destemmer system to make harvesting possible in even the most confined vineyards. The result is improved cleaning and performance.

## **Productivity & harvest care**

The harvest season is now shorter than ever. The new BRAUD 7030M and 8030L models can be set up to work in different vineyards quickly and with maximum efficiency. The SDC shaking system with the new low grape shaking feature, maximizes your crop production so you can get the most from your vineyard. The integrated Intelligent Management System 2.0, with IntelliView™ IV touchscreen monitor, provides full access to all key harvester functions. Optimizing productivity for all vine types has never been easier.

## **Fuel efficiency & maneuverability**

With new FPT Industrial common rail electronic engines, you get improved output and economy. With an output of 128 hp, the new Tier 4B ECOBlue™ HI-eSCR engines deliver more power and torque with best-in-class fuel efficiency. The compact frame enables the machine to have outstanding time-saving maneuverability, even on tight headlands.

## **Best-in-class comfort & safety**

Step up into the superb new BRAUD 7030M and 8030L cab. The seat and steering wheel adjust to provide a perfect fit for the driver. The standard armrest, with integrated joystick, provides easy access to the most used functions. Safe, quiet and comfortable, the cab complies with European standards EN 15695-1:2009 Category 4 Cab and EN 15695-2:2009 Category 4 filter, and can be fitted with the unique Blue Cab™ 4 system.

## **Fast & easy maintenance**

The new BRAUD 7030M and 8030L models have been redesigned to minimize maintenance time and costs. The picking head wash time is reduced thanks to the strategically positioned water supply pipe and fewer debris accumulation areas. The new Noria tension system and transport lock helps reduce maintenance and preparation time. You don't have to replace destemmer parts as often, and the first service requirement for the FPT Industrial common rail engine is not until 600 hours. Less downtime creates quicker harvest times.

# The most awarded brand in history.

**1975:** Braud 1020, one of the very first self-propelled grape harvesters rolled off the production line in 1975. This machine would revolutionize the face of grape harvesting.

**1980:** The arrival of the **Braud 1014** with the revolutionary Noria basket conveying system raises the bar for harvesting quality.

**1981:** The **Braud 914**, the first compact-sized machine for smaller vineyards.

**1984:** Braud joins forces with Fiat Agri, marking the dawn of a new era of technology development.

**1988:** The Model **Braud 2420** and **Braud 2620** equipped with the SDC shaker system are launched. Outstanding grape and vine care becomes standard.

**1989:** **Braud 1620**, featuring an extendable frame for various vineyard conditions.

**1997:** The **Braud Saphir** SB Medium range represented an entirely new product segment for a compact sized machine.



1975

1980

1981

1984

1988

1989



## A history of harvesting excellence

In 1975, Braud developed their first self-propelled grape harvester and the face of viticulture changed forever. Today, these state-of-the-art New Holland Braud machines are designed, developed and built by engineers that live, breathe and sleep wine and olives at the New Holland Braud Center of Excellence in Coex, France. This pioneering plant is at the forefront of sustainable production, with innovative plans to reduce the environmental impact and carbon footprint of harvester manufacturing.

**2002:** The destemmer separator is launched, a quantum leap in harvesting quality for the purest wine ever.

**2004:** Medium and large vineyards can now select the **Braud VM300** and **VL500** Series for enhanced mechanization. Fitted with a shaker rod aperture adjustment system, the SDC shows its true potential for grape harvesting.

**2007:** Tier 3 engines were installed on **Braud VM3000** and **VL5000** Series.

**2013:** **Braud VM 3000 Plus** and **VL5000 Plus**, with EMS system for improved fuel efficiency, extra Noria division, cameras, and spare shaker rack appeared on these models.

**2015:** New compact range with **Braud 7030M** and **8030L** for medium and large vineyards, featuring the Gold-Medal-winning Opti Grape™ sorting system, Tier 4B FPT Industrial engine with ECOBlue™ HI-eSCR and award-winning Blue Cab™ 4 filtration system, all wrapped into a compact design.



1997



2002



2004



2007



2013



2015



MORE THAN 14,000 GRAPE HARVESTERS SOLD IN OVER 30 COUNTRIES AND THE STORY CONTINUES...

## At the heart of Braud DNA.

---

For 40 years, our specialist teams at the Coëx factory in France have designed, fine-tuned and produced more than 14,000 grape harvesters. Braud is the benchmark in terms of production quality, grape harvesting quality, care and response to multifunctional expectations for wine growers throughout the world. The SDC system (Shaking Dynamic Control) with flexible rear rods, and the Noria collection system are benchmarks in terms of grape shaking efficiency, respect for the vine stock, fruit integrity and minimizing losses.



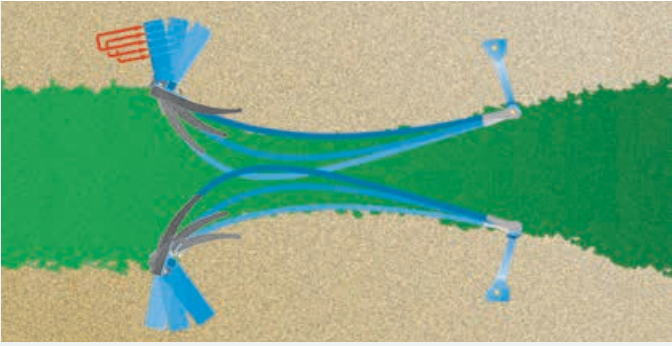

### SDC shaking system

The BRAUD SDC is recognized as the best picking system. Each shaking rod is independent and hinged at the rear on a maintenance-free flexible fixation. This fixation allows perfect control of the shaker action, with maximum flexibility, for gentle picking.



### Low grape shaking

A clever redesign allows the first shaker rod to be mounted below the shaker plate bearing, ensuring even the lowest hanging grapes are picked. As a result, the first shaker is mounted just 1.57 inches above the top of the Noria basket.



### Adjustable rod aperture

The SDC shaker rod's lateral distance can be adjusted thanks to two electrical actuators. You can make changes from the cab to adapt the shaker rods to fit any vineyard canopy conditions.



### Adjustable shaker plate

As standard, Braud 7030M and 8030L are fitted with an adjustable shaker plate. This quick release shaker plate allows the operator to easily adapt the chosen shaker rod to the fruit bearing zone.





# Your wine, treated with care from the beginning.

Since 1980, the Noria Basket system has conveyed every single grape harvested by a BRAUD harvester. Since then, we have been constantly improving and refining the system for higher speed, productivity and loss reduction. The BRAUD Noria system: the benchmark for grape harvesting.



## Noria collection: a must have

At New Holland BRAUD, respect for the vine and grapes is a design priority. The proven NORIA with its polyurethane baskets, ensures total care of the vines and fruit without ground losses. Braud 7030M provides 6.23 feet of sealed length, and the Braud 8030L has extra capacity with 6.88 feet of sealed length and XXL size baskets.



## No fruit maceration

The grapes collected by Noria baskets at the very bottom of the harvesting head are conveyed gently, without loss or maceration, up to the top of the harvesting head, always by the same basket. Simple and effective.



## Cleaning conveyor

The cleaning conveyors are optimized for even crop distribution. The Braud 7030M is fitted with a 17.91-inch-wide conveyor, while the Braud 8030L has a 23.62-inch high-capacity conveyor to help cleaning. With Braud compact line conveyors, you get the right size for the best cleaning performance.



## High-capacity cleaning fans

Cleaning fans have been optimized to improve crop sample cleanliness. The cleaning always occurs when the crop is in freefall, for better effectiveness on lightweight material. The redesigned fan exhaust now directs fan airflow to the rear of the machine for less dust, less noise, and less residue accumulation. The end result is, it's easier to wash!

# An easy day. During and after the job.

The new Braud Compact line has been designed with the operator in mind, with excellent ergonomics, user friendliness, safety and easy maintenance being key focus points.

## Spare shakers always on board:

Useful features such as the shaker rack allows up to four spare shaker rods to be carried on board the machine.



## New hoppers

The hoppers have been redesigned to increase capacity while lowering the center of gravity. A new top fan exhaust directs dust to the rear, away from the machine. With the dedicated hopper filling system, the Braud compact harvesters increase overall vineyard autonomy.



## Water pipe

The new harvesting head has been designed to make washing easier. Carefully positioned pipes direct water where it needs to go, in order to effectively clean all key harvesting head areas with no effort.



## Centralized greasing

To facilitate and reduce maintenance, all harvester head grease points are grouped together where you can reach them easily from the head platform. Lifetime greased bearings make the rear legs of the tractor unit maintenance free. The MECALOR automatic greasing system is available as an option.



### **New harvesting head transport lock**

A new locking system prevents swinging of the harvesting head for added safety. Just move the handle, and a pin automatically locks the head swing for safe road transport.



### **Reduced and simplified maintenance**

Maintenance of Braud Compact harvesters is now even easier. Advanced new components make ownership and maintenance more cost effective and straightforward. A new Noria tensioning system allows for tool-free tensioning of both Noria sides, using a simple crank handle to move the Noria rails up and down.

# Destemmer evolution.

The new BRAUD 7030M and 8030L models can be fitted with a SOCMA patented evolution destemmer. Fitted on the top of each hopper, the system delivers outstanding harvest quality.

## Outstanding impurity elimination

The evolution destemmer eliminates on average 20% more harvest impurities than the system employed in previous models. An advanced trap removes the majority of stalks, leaves and MOG, material other than grapes. A dedicated MOG transfer auger discharges this material to the ground.

## Bigger hopper capacity

A specially designed crop distributor, combined with two infrared level sensors, allows the hopper to be filled completely and automatically. Hopper capacities are an increased 608 gallons (2300L) for 7030M and 740 gallons (2800L) for 8030L models, but with a lower center of gravity, and an integrated top fan exhaust to the rear.

## Gain in quality, gain in productivity

The evolution destemmer is positioned so it does not compromise the hopper capacity. It has a high throughput for optimum productivity.

## Reduced and simplified maintenance

Maintenance on the Braud 7030M and 8030L harvesters has been simplified and reduced. Advanced new materials, sealed bearings and a smoother conveyor path make looking after these new-generation harvesters less expensive and more straightforward.



# Opti-Grape™ : premium quality grapes.



The aim of the award-winning Opti-Grape™ system is to remove as much MOG as possible from the harvested grapes. It is a premium system created for wine growers who demand the highest possible harvest quality. It delivers up to five times better cleaning performance by means of a unique, air cushioned cleaning surface. As a result, the winemaking process from the vineyard to the cellar is also enhanced, and a higher quality, more profitable harvest is achieved for the grower.

## Top grape quality

The Opti-Grape™ system has been specifically designed to maximize harvest cleanliness. It is intended for wineries and cellars targeting low- to middle-yielding grapes. The MOG separation process is controlled by an air cushioned surface, generated by a rotary turbine blowing air through a fine mesh grid.

## Adjustable settings

The turbine speed generating the air flow adjusts directly from the cab using the IntelliView™ IV monitor. A performance evaluation kit, supplied as part of the Opti-Grape™ system, enables the driver to sample the impurities rejected. As a result, drivers can adjust their own sorting parameters, depending on the harvest conditions, the grape variety and also according to their own sorting expectations.

## Impurity selection

The air cushion surface enables a wide range of impurities of all shapes and all sizes to be removed, such as petioles, stalks, bits of leaves, wood, stems, etc. It is also effective at removing dry and moldy fruit, and also botrytized fruit which may be present during difficult harvest conditions.

## Reversible functionality

When the Opti-Grape™ system is not required, manual opening flaps and a reverse function activated from the cab direct all harvested crop into the hoppers.

## Crop distributor

A specially designed crop distributor, combined with two infrared level sensors, allows the hopper to be filled completely and efficiently. The hoppers have also been redesigned and adapted to accommodate the Opti-Grape™ system, but without compromising hopper capacity. A lower center of gravity and an integrated top fan exhaust to the rear add to the improvements.

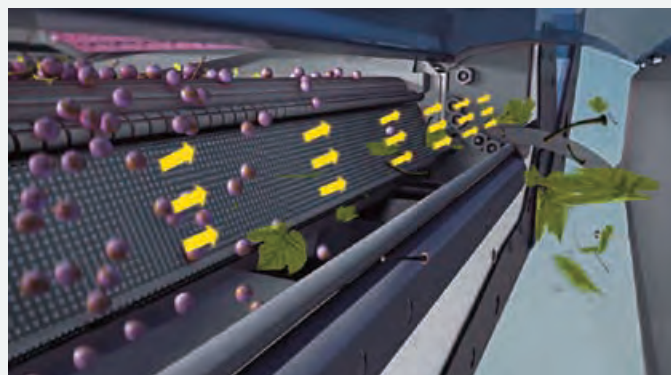

# Compact and powerful.

The BRAUD compact line is powered by ultra-efficient FPT Industrial 4-cylinder Tier 4B ECOBlue™ HI-eSCR common rail electronic engines creating 128 horsepower.

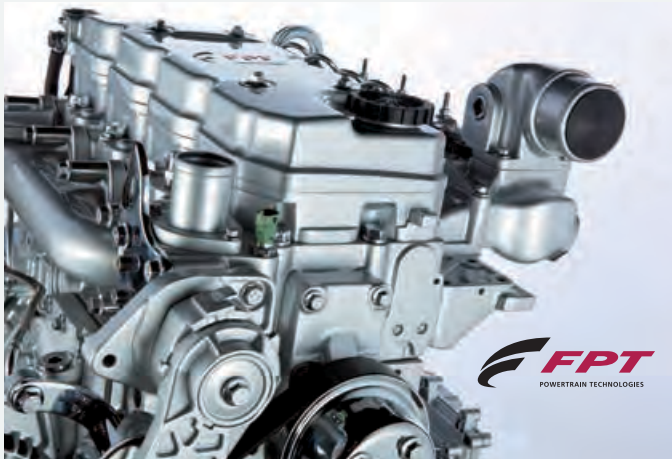

## IMS 2.0 new generation intelligent management system

Awarded a silver medal at Sitevi 2009, the Braud IMS 2.0 new generation offers further functionalities: combined with the new IntelliView™ IV monitor, it continually monitors the demand on the engine, keeping the harvesting parameters constant, but also taking into account the terrain and hydrostatic load, to constantly adjust engine rpm. Furthermore, the Braud compact line also features a new hydrostatic system, allowing travel on the road at 15.5 mph, with reduced engine rpm. This results in optimized fuel efficiency, and better slope management.



### Outstanding fuel efficiency

New Tier 4B ECOBlue™ HI-eSCR engines, combined with IMS 2.0 New Generation Intelligent management system offer outstanding fuel efficiency and economy. This has been evaluated with UTAC-type comparison tests between existing VM / VL and VM / VL Plus harvesters.

**ECOBlue** HI-eSCR

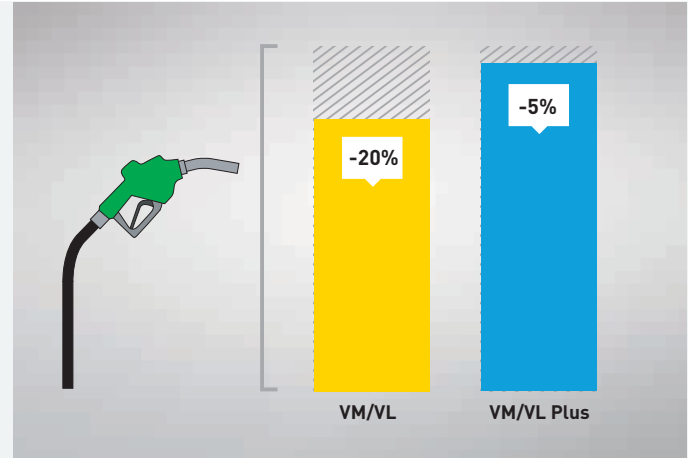

### Anti-Skid system, the benchmark for handling tough terrain

The heavy-duty hydrostatic transmission delivers enhanced traction and improved performance in demanding terrain. Anti-Skid automatically manages drive to the wheels for optimum performance on slopes and in wet soil conditions. The front hydrostatic hoses have been re-routed to maximize steering efficiency. New 15.74-inch tires help to minimize soil compaction.



### New automatic height and levelling

IMS 2.0 automatically controls the picking head height and levelling. The operator simply sets the desired picking head height, and the system automatically maintains it, regardless of the terrain. Sensors, fitted as standard, prevent the picking head from ever making contact with the ground in difficult conditions.



### Compact frame for best-in-class turning radius

Both tractor and harvesting head have been designed with compactness in mind. This is clearly demonstrated in the design of the rear of the machine, where the Noria does not protrude beyond the rear tire. This allows earlier turns when exiting the row.



# Harvest in first class.

Braud 7030M and 8030L harvester cabs are recognized as the industry benchmark. The cabs are fully suspended and soundproofed for a smoother, more comfortable ride. Pressurized, heated and air-conditioned, the cabs are designed to offer optimum comfort and protection during harvest, spraying and other operations. Noise levels are reduced by 3dB(A) compared to the previous harvester range.



## Full visibility

The Braud 7030M and 8030L cab, combined with a specially profiled engine hood allows full visibility even on the right side of the machine, giving you full control during harvesting.







### Shade and space

Braud compact harvester cabs are fitted with 2 sun shades, one on the front windshield and one at the rear. They provide comfort even in the brightest harvest conditions. Attention to design detail includes improved in-cab storage areas. A fold-down laptop table\*, coat hook and elastic storage net are standard.

\*not available with 7030M



### Total control

The new light control panel (LCP) gives access to all 12 lights and beacon around the machine. All Braud 7030M and 8030L are fitted as standard with a Bluetooth Radio for hands-free connectivity.

### Night work

A total of 12 lights illuminate your work, with the addition of two new side lights. Mounted on the left and right sides of the cab, they help visibility when maneuvering at night. Extra additional lights can be fitted as an option.

### 360° vision

Two cameras are fitted as standard and the in-cab color monitor can accommodate a total of four cameras to enhance visibility and view machine functions.



### Easy access

A new electrically actuated ladder platform makes cab access safe and easy. An LED light automatically lights the way when climbing the steps at night.

# Blue Cab™ 4 system: ultimate protection and comfort.



Blue Cab™ 4 technology combines both the cab filtration system and the comfort pack options. It is intended for multi-function activities such as spraying, or also those who expect the highest comfort with unique features. A heated and air ventilated two-tone seat ensures comfort all day long.



## Cool box

The 8030L with Blue Cab 4 system features a 12V cool box, meaning a refreshing drink is only ever an arm's length away. Want more? It's portable so you can easily remove for replenishment.



## Auto air-con

Blue Cab 4 technology also brings with it new levels of comfort with integrated automatic air conditioning.



## LED lights

With the Blue Cab 4 system, the lighting package raises the lighting bar. The spread of the LED light is engineered for maximum visibility of the entire machine and working area. A total of over 10,000 lumens produce the best visibility for all kinds of work.

# BLUE CAB<sup>4</sup>



## Level 4 filtration (EN15695-1 and -2) and even more...

The Blue Cab 4 system is the most advanced cab filtration system on the market: it features not only category 4 filtering, and closed loop cab pressurization system but also includes category 2 filtration, used when category 4 is not needed. The filtration switchover is easy since category 4 automatically starts when a spraying unit is hitched and activated. On the road, only category 2 is used.

## Pure air

The system includes a filter management system, helping to manage maintenance intervals and filter usage. Also included is a unique and patented auto air cleaning valve for purging air in cab when the category 4 filtration starts.

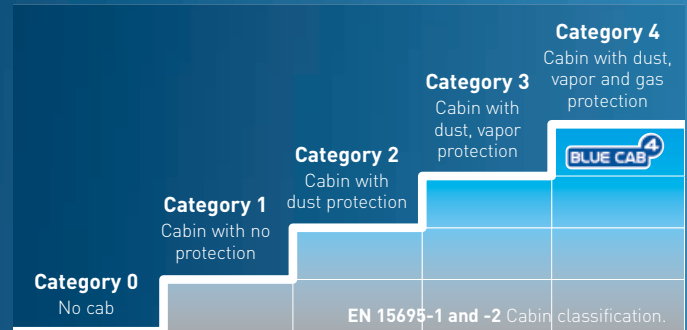

# Maximized Performance

Intelligent and intuitive automation saves time and enhances harvesting performance. The multi-function handle is your right-hand harvesting helper. You can control all key machine parameters, including travel speed and direction, manual levelling and the picking head. The right armrest can be adjusted in length and height, and machine functions can be analyzed at a glance courtesy of the IntelliView™ IV touchscreen monitor.

Raise right hopper

Raise both hoppers

Raise left hopper

Lower both hoppers

Lower right hopper

Lower left hopper

Raise machine

Tilt machine left

Tilt machine right

Lower machine

Engage conveyor and cleaning

Menu button: access menu to set parameters

Adjust parameters within selected menu

Engage shaking system



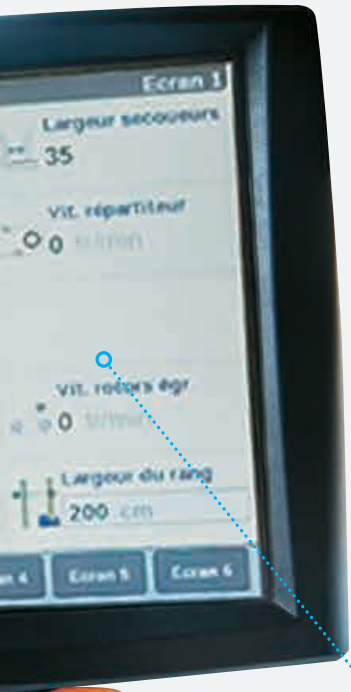

### IntelliView™ IV Plug and Play

The ultra-wide 10.4-inch IntelliView™ IV color touchscreen monitor is fixed on a sliding rail which can move up and down the cab pillar so you can position it just where you want. When compatible multifunction implements are connected, the IntelliView IV monitor automatically sets work pages for easier control and management of the machine.



### Row Tracking System

The optional RTS system uses GPS technology to map the rows on the IV4 monitor, displaying harvested rows, missed rows and overlaps—especially useful during night work and spraying applications.

All grape harvester functions and parameters can be simply and easily adjusted by touching the IntelliView™ IV monitor.



- Maximum engine speed setting
- Minimum engine speed setting
- Engine start
- Flow divider (if fitted)
- Cruise control
- Road mode

# 360°: Braud 7030M and 8030L.

The new BRAUD 7030M and 8030L models have been designed to spend more time working and less time in the yard. All service points are easy to access, and long service intervals mean they will spend more time in the vineyard.



Both fuel and AdBlue tanks can be filled from ground level.



### Will I be able to find AdBlue® easily?

The answer is yes! It will be available through CNH Industrial Parts & Service. AdBlue can even be delivered direct to your farm for absolute convenience.

Two-piece engine hood opens wide for full service access: front hood flips up perfectly for accessing the engine, side door swing with a gas strut for cleaning and servicing hydraulics and coolers.

Cooling package opens out to make cleaning faster and easier.

The engine air filter is easy to check, clean or replace, with no need for tools, and is accessible from the ground.



Washing has never been so easy, with a specially designed access platform, a new water supply valve and pipe, and also washing buttons externally positioned on a cab pillar.

Both Cab air filters (Category 2 and 4) can be easily changed without tools, from the harvesting head platform. The IntelliView™ IV screen can alert the operator when the category 4 filter needs replacing.



Engine oil check and fill points are easy to reach. You will also still be able to enjoy the long 600-hour service intervals that you've come to expect of New Holland.



### Dealer-installed accessories

A comprehensive range of approved accessories can be supplied and fitted by your dealer.

# All-year productivity.

---

The base unit is designed to be used all year long, from pre-pruning to grape harvesting. In order to achieve this, a new patented system to couple and uncouple the picking head and a new front tool carrier were developed.

## Simple picking head implements

One person can remove the picking head, without special tools, in 30 minutes. All hydraulic and electrical connections are grouped together for easy access.







### Front tool carrier

Purpose-developed for the new BRAUD 7030M and 8030L models, the all-new front implement carrier can be fitted by the operator quickly and easily. Implements, including a trimmer, prepruner and leaf-remover, can be fitted with fully integrated control via the IntelliView IV touch screen. The implement carrier telescopically adjusts both horizontally and vertically to suit the implements. It can be set to move away from the cab during a turn.



### Pre pruner MP 122 Provitis

Pre-pruning head with two banks of shearing discs, with working heights from 19.1 inches to 39.1 inches.



### Leaf remover LR 350 Provitis

The frame is composed of two leaf removing heads, each head is equipped with hydraulic width adjustment. The leaf remover can be combined with a trimmer (two jobs in one step).



### Berthoud co-design

Berthoud spraying equipment, co-designed with BRAUD, attaches in around 30 minutes, with full touch screen operation via IntelliView IV.



### Trimmer ST 120 Provitis

Adjustable cutting bars feature 16.9-inch rotary blades, rotating at a speed in the range of 2000 rpm. The trimmer is offered in two models (one row or one and two half rows) with cutting heights of 48.4, 55.9, and 68.9 inches.

MODELS		BRAUD 7030M	BRAUD 8030L
Vineyard row spacing	ft. (m)	Intermediate >4.26 (>1.3)	Large >5.24 (>1.6)
<b>Engine</b>			
Type		FPT NEF	FPT NEF
Compliant with engine emissions regulations		Tier 4B/Stage 4	Tier 4B/Stage 4
Power ECE R120/ISO 14396	hp [kW(CV)]	128 (94)	128 (94)
Cylinders / Aspiration / Displacement (cm <sup>3</sup> )		4 / Turbo with Intercooler / 4485	4 / Turbo with Intercooler / 4485
ECObLue™ HI-eSCR system (Selective Catalytic Reduction)		●	●
Reversible cooling Fan		●	●
<b>Tractor base unit</b>			
Diesel capacity / AdBlue capacity	gal. (L)	42.3/10.8 (160/41)	42.3/10.8 (160/41)
Heavy Duty Hydrostatic transmission with Anti-Skid system		●	●
Road speed (25kph) with reduced engine rpm		●	●
Maximum steering angle	degrees	90	90
Front wheel torque limiter		●	●
Maximum slope (with auger)	%	32	32
Maximum slope (with destemmer)	%	30	30
Maximum slope (with Opti-Grape™)	%	25	–
Maximum lateral slope	%	25	25
IMS 2.0 - Intelligent Management System 2.0		●	●
CDHA - Automatic height and lateral slope correction		●	●
Cruise control with radar		●	●
Electric park brake with brake pedal and seat button		●	●
Front multifunction tool carrier		○	○
<b>Harvesting head</b>			
Number of SDC shakers (std.)		12	14
Low grape shaker rods		●	●
Flexible rear shaker fixation		●	●
Semi-Quick coupling of the picking head		●	●
Electric Shaker rod aperture adjustment		●	●
Quick release shaker plate		●	●
Ground sensors		●	●
Sealed length of collection baskets	in. (mm)	74.8 (1900)	82.7 (2100)
Number of collection baskets		2x54	2x58
Basket size		STD 3 rivets	XXL 4 rivets
Noria tensioning system		●	●
Easy head swing lock system		●	●
High capacity cleaning conveyors	in. (mm)	17.7 (450)	23.6 (600)
Upper cleaning fans		●	●
Rear fan exhaust with flap		●	●
Stainless steel hoppers	gal. (L)	607.6 (2300)	660.4 / 739.7 (2500 / 2800)
Destemmer with crop spreader and AutoFill		●	○
Opti-Grape™ with crop spreader and AutoFill		○	–
Harvesting head centralised greasing		●	●
Washing water supply pipe and valve		●	●
Washing external buttons		●	●
Magnets		●	●

MODELS		BRAUD 7030M	BRAUD 8030L
<b>Cab</b>			
Cab inside Volume	ft <sup>3</sup> (m <sup>3</sup> )	76.6 [2.17]	78.8 [2.23]
Cab glass area	ft <sup>2</sup> (m <sup>2</sup> )	79.5 [2.25]	80.2 [2.27]
Actuated access ladder and platform with light		●	●
Protective structure		ROPS code 4	ROPS code 4
Air conditioning and refrigerated box		●	●
Cab filtration system/Category level [EN 15695]		● / 2	● / 2
<b>Blue Cab™ 4 system Pack:</b> Featuring Category 4 filtration [EN 15695-1 and -2], Automatic A/C, heated and ventilated two tone deluxe seat, LED working lights, removable 12V Cool box (only for 8030L with Blue Cab™ 4 system)		●	○
Bluetooth Radio with separated microphone (hands free phone calls)		●	●
2 speakers integrated system		●	●
Adjustable armrest & multifunctional joystick		●	●
IntelliView™ IV touch screen monitor with adjustable position		●	●
Split screen color monitor for cameras		●	●
Cameras (color)		2 ● / +2 ○	2 ● / +2 ○
Steering column and adjustable seat		●	●
Lights with dedicated Light Control Panel (LCP)		12	12
Mirrors with electrical adjustment		●	●
Right mirrors retractable		●	●
Front and rear sunshades		●	●
<b>Premium Viticulture/PLM</b>			
Row Tracking system GPS NH 162 (RTS)		○	○
Hopper level indicator (progressive)		○	○

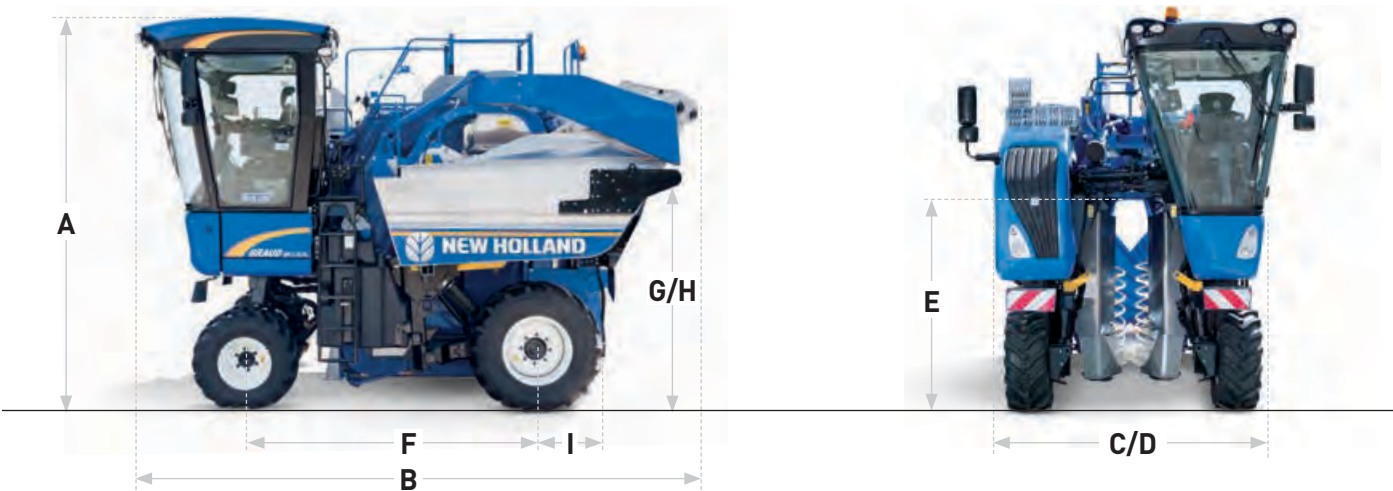

MODELS		BRAUD 7030M	BRAUD 8030L
<b>Dimensions and tires</b>			
Front tires available		320-70R20 / 340-80R18	340-80R18 / 400-70R18
Rear tires available		340-85R24	420-70R24 / 460-70R24
<b>A</b> - Maximum height with cab, harvesting head on the ground	ft. in. (m)	11' 11" [3.63]	11' 10" [3.60]
<b>B</b> - Maximum length	ft. in. (m)	16' 6" [5.03]	17' [5.17]
<b>C</b> - Maximum width of base unit	ft. in. (m)	8' 7" [2.61]	9' 1" [2.77]
<b>D</b> - Width with harvesting head fitted at the rear wheels	ft. in. (m)	7' 1" [2.15]	8' 10" [2.69]
<b>E</b> - Ground clearance	ft. in. (m)	5' 11" to 7' 7" [1.80 to 2.30]	6' 5" to 8' [1.95 to 2.45]
<b>F</b> - Wheelbase	ft. in. (m)	9' 1" [2.78]	9' 1" [2.78]
<b>G</b> - Maximum hopper tipping height, under hopper	ft. in. (m)	7' 11" [2.41]	8' 3" [2.51]
<b>H</b> - Maximum hopper tipping axis height	ft. in. (m)	8' 4" [2.53]	8' 8" [2.63]
<b>I</b> - Harvesting head rear offset (from wheel axle)	ft. in. (m)	2' 0" [0.62]	2' 6" [0.76]

● Standard ○ Optional – Not available



# VALUE, SERVICE AND SOLUTIONS

New Holland offers complete solutions for your harvesting needs. You get peace of mind knowing New Holland harvesters gently handle your prized grapes and olives, while also boosting your productivity for a better return on your investment.

**Support at every step.** When you place your confidence in New Holland agricultural equipment, you get the finest in local support. Your New Holland dealer understands the many challenges you face and stands behind you at every step with the equipment, parts, service and financial solutions to make your job easier. Look to New Holland for a complete selection of equipment, including a full line of tractors, hay & forage equipment, harvesting, crop production and material handling equipment.

**Quality parts and service.** Turn to your New Holland dealer after the sale for expert, factory-trained service and genuine New Holland-branded parts. Your dealer has the very latest service updates and training to ensure your equipment keeps working productively season after season.

**Financing solutions.** Your New Holland dealer can tell you about smart ways to turn your financial challenges into opportunities with a portfolio of innovative financial services available through CNH Industrial Capital, including customized financing, leasing, insurance and the purchasing convenience of a Commercial Revolving Account.

For reliable equipment, parts and service — or just honest advice on equipment and finance — turn to New Holland and your trusted New Holland dealer.



We are proud to support the FFA.

Learn more at [www.newholland.com/na](http://www.newholland.com/na)

Design, materials and/or specifications are subject to change without notice and without liability therefor. Specifications are applicable to units sold in Canada, the United States, its territories and possessions, and may vary outside these areas.

© 2016 CNH Industrial America LLC. All rights reserved. New Holland is a trademark registered in the United States and many other countries, owned by or licensed to CNH Industrial N.V., its subsidiaries or affiliates. Any trademarks referred to herein, in association with goods and/or services of companies, other than owned by or licensed to CNH Industrial N.V., its subsidiaries or affiliates, are the property of those respective companies.



Safety begins with a thorough understanding of the equipment. Always make sure you and your operators read the Operator's Manual before using the equipment. Pay close attention to all safety and operating decals and never operate machinery without all shields, protective devices and structures in place.

NH31703021 • 0216XX • OTP • PRINTED IN U.S.A.