

# GRAIN HANDLING ACCESSORIES



# It's not an ordinary auger... It's a Westfield

AGI Westfield has developed and refined the best grain augers available. To make your job even easier, we also offer a full lineup of options and accessories.

## Straight Auger

### OPTIONS

#### Self-Propelled Heavy-Duty Mover

This new mover features all-wheel drive, hydraulic steering, and rugged all-terrain tires capable of handling tough terrain. The narrow, more compact design and controls situated further back on the tube allow better access to larger diameter hopper bins. You can also make sharper turns for quick and easy repositioning. Hydraulic steering comes standard.



#### Poly Hoppers

Durable, flexible poly hoppers allow easy dumping with minimal spillage. Offered in two styles, the V-style hopper fits augers sizes from 6" - 10" in diameter, and the large round hopper fits 8" and 13" diameter augers.



#### Steel Intake Hopper

This hopper makes it easy to unload bins and fill trucks with its tapered transition neck to maximize capacity. Featuring Wear Edge Technology™ to extend the life of the flighting, the hopper also features a removable access plate for easy clean-out and is self-leveling for quick set up.

8" = 36" L x 36" W  
10" = 36" L x 36" W  
13" = 40" L x 40" W



#### Work Light Kits

When the sun goes down, LED work lights provide enhanced lighting conditions at the hopper, axle, and tube discharge.



#### Electric Clutch

Allows operator to start and stop the auger without shutting down gas engine drives. Quick installation and controls at intake end of auger. Fill truck boxes to optimal levels and provide another level of shutdown safety during operation.

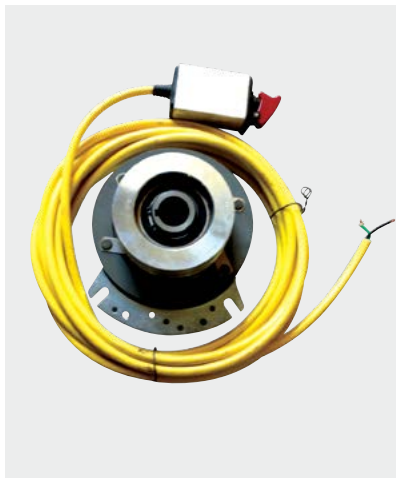

#### Reversing Gearbox

The reversing gearbox allows the auger to be reversed at all angles and includes the linkage and lockout for easy clean-out.



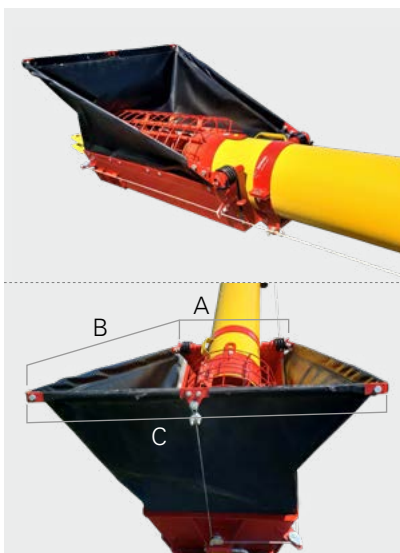

### Enclosed Collapsible Hopper

This new hopper option is easy to attach and minimizes spillage. Connecting with two hitch pins, this cost-effective option mounts over your existing intake cage and has a removable access door for easy clean-out. Includes a tow hitch.

### Specifications

	8"	10"	13"		8"	10"	13"	
<b>A</b>	16"	18.5"	20.75"	<b>COLLAPSED HEIGHT</b>	8"	9.5"	11"	
<b>B</b>	36.5"	36.5"	36.5"		<b>TOTAL HEIGHT</b>	26.5"	27.5"	29"
<b>C</b>	33"	35.5"	37.5"					

# Swing Away

## OPTIONS

### Power Swing

Available in 12V remote electric or hydraulic drive, the Power Swing features a two-wheel drive design and large lug tires for maximum traction and balance. Wheel traction is easily adjusted with the scissor lift engineering.

Easily mounts to the MKX low profile hopper and requires minimal height adjustments when ranging from one height to another, making quick work of setting up.

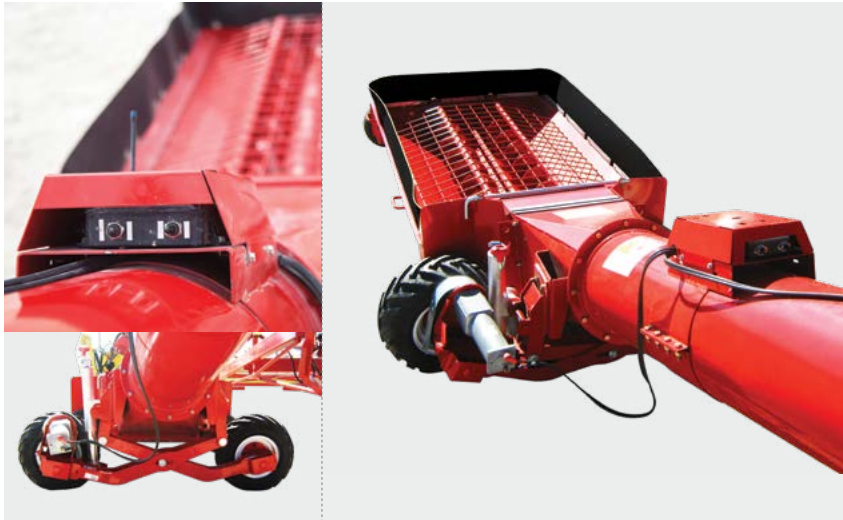

### Hydraulic Power Swing

To make the Power Swing even easier, we offer a hydraulic drive system to move the hopper. Controls are conveniently mounted to the tube. Comes complete with hydraulic hoses.

### Poly Transfers

This poly hopper with 9" tube is lightweight and resists corrosion. Easy, one person handling and storage. The 8' 2" length stores horizontally on semi trailers for transport. Adjustable discharge angle for low trailers. Available in hydraulic drive only.



Just 125 lbs.  
The lightweight  
alternative!

### Remote 12V Electric Power Swing

Using a heavy-duty 12V motor with a large "Easy Grip" remote, the electric power swing helps you easily position the hopper without leaving the truck.



### Light Kits

Light kits are available to increase visibility while in transport and for during work. Can be ordered separately.



## GULP<sup>2</sup>

The GULP<sup>2</sup> drive over hopper is available for the MKX 13 and is designed to match the auger's capacity.



## Quick-Mount Drill Fill

This unit is true to its name with its fast-mounting and dismounting single pin. The long 6" by 15 1/2' auger allows full tarping of the load and comes with steel or bristle flighting. The on/off controls are located on the 14 1/2' telescoping downspout. The Drill Fill also features a 4.2 in<sup>3</sup> hydraulic motor with 12V solenoid control, located at the bottom of the auger requiring minimal plumbing.

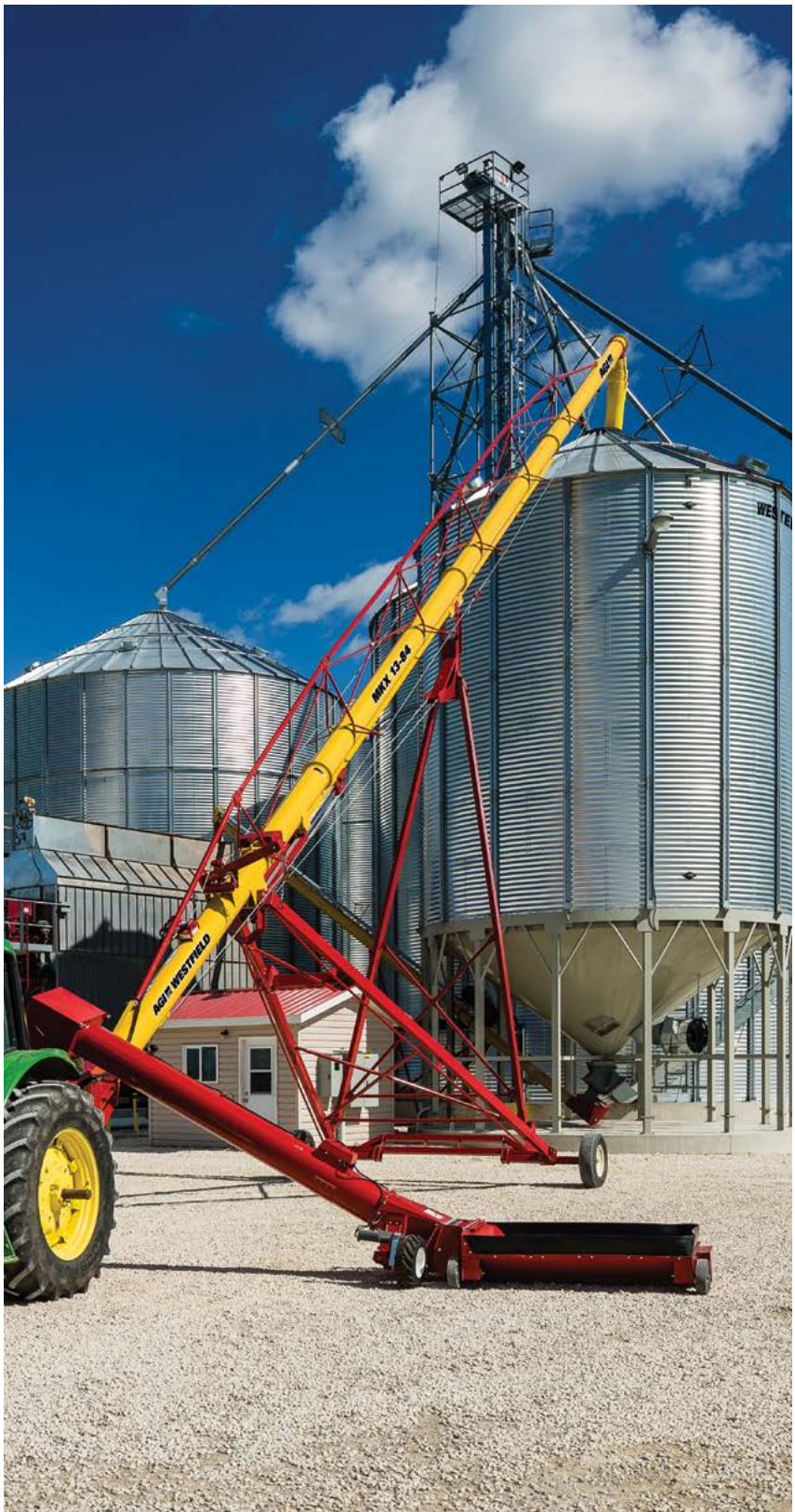

# X-Tend

## Retracting Swing Auger

AGI Westfield's retracting swing auger offers the convenience of being able to extend, swing side-to-side and retract, without having to move or reposition the truck. The X-Tend was designed to work with the MKX 13 & 16 and the X 13, It's fast and convenient!



Note: The X-Tend is also available on the AGI Westfield MKX line of A-frame augers

### FEATURES

- Low profile hopper positions under grain trailers with ease
- Hydraulic power swing with large lug tires, allow for precise positioning and maximum traction
- Dual flighting channels grain flow into the swing tube matching the capacity of your 13" or 16" swing auger

### X-TEND

	13	16
STROKE	9'	9"
WORKING RETRACTION	20"	24"
MAIN FLIGHT THICKNESS	0.25"	0.25"
CORE DIAMETER	2.375" OD	2.375" OD
TRANSITION FLIGHT THICKNESS	0.25"	0.25"
TUBE LENGTH	17'	17'
HYDRAULIC CONTROLS	3-way, mounted on swing tube	3-way, mounted on swing tube
POWER EXTEND	Yes	Yes
MECHANICAL DRIVE	Yes	Yes



Once a grain trailer is in position, the swing tube is extended. The power swing moves the low profile hopper side-to-side, reaching the truck hoppers with ease. The X-Tend then retracts to allow grain trailers to drive away.

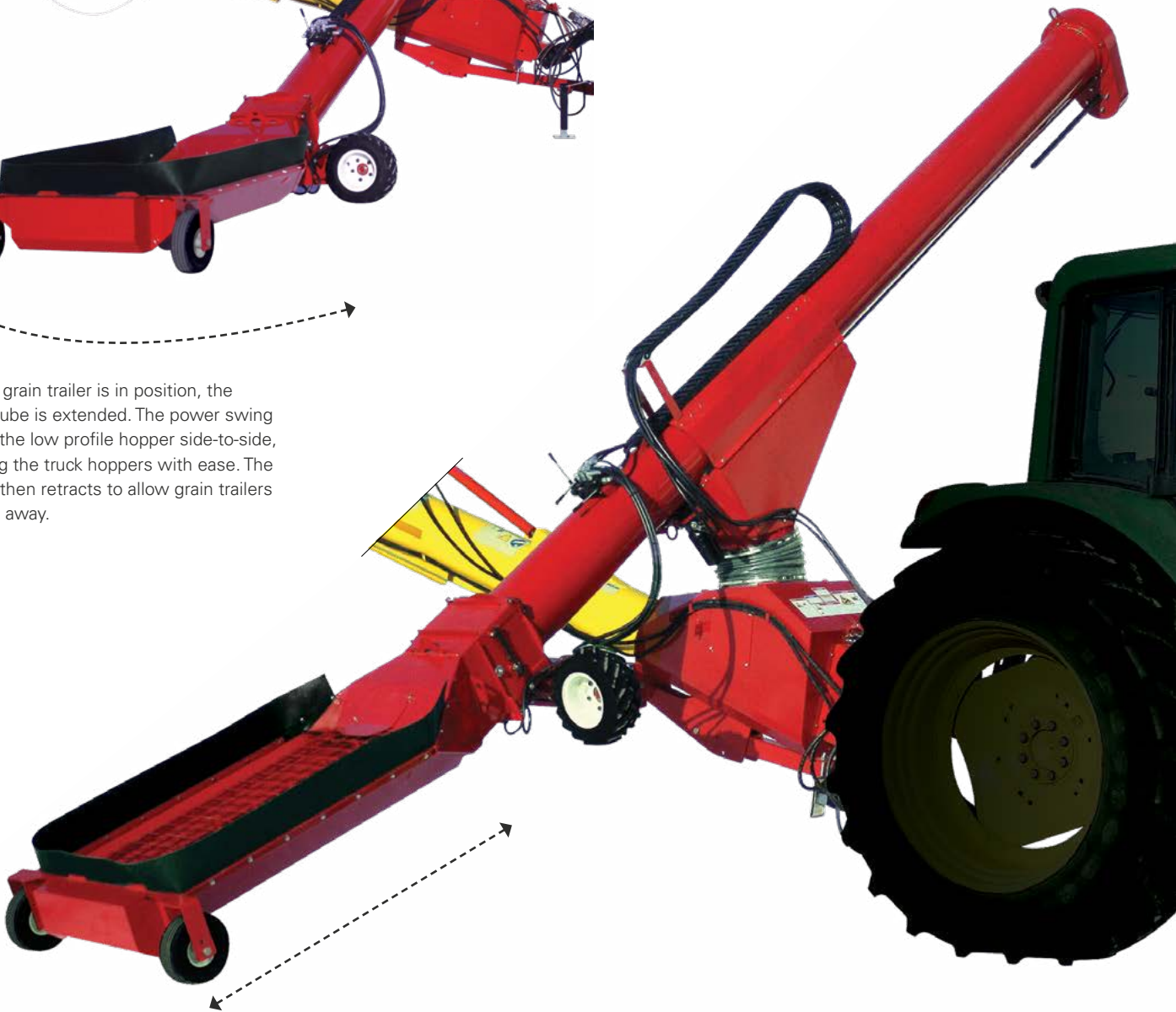

# Transfer Augers

AGI Westfield's transfer augers are available in 8" and 10" diameters. These low profile transfers are just 10 ¾" high and are light and maneuverable. The hopper fits nicely under hopper bottom bins and trailers for fast and easy unloading.

## DRIVE OPTIONS

---

### Electric Drive

Available on 8" and 10" and features a heavy-duty motor mount with enclosed belt guard, belts, and pulley\*.

- Electric HP requirements  
8" - 3 HP | 10" - 5 HP

### Hydraulic Drive

Shipped complete with hydraulic control valve.

- Hydraulic motor requirements  
8" single drive | 10 GPM @ 650 PSI  
10" double drive | 10 GPM @ 1000 PSI

### Gas Drive

Available on 8" and 10". Features heavy-duty engine mount with adjustable belt tension for engaging and disengaging auger while motor is running. Shipped complete with enclosed belt guard, reduction gearbox, belts and pulley\*.

- Motor requirements  
8" - 5.5 HP | 10" - 7.5 HP

---

All transfers are shipped complete with undercarriage | \*Motor and motor pulley not included.

---





	HOPPER HEIGHT	HOPPER LENGTH	TOTAL LENGTH	HOPPER WIDTH	TUBE LENGTH	SPOUT HEIGHT	HANDLE HEIGHT	TUBE DIAMETER	ELEC. HP REQ.	GAS HP REQ.	HYD. REQ.
	A	B	C	D	E	F	G	H			
8"	10 3/4"	48"	105"	35 3/4"	60"	25 5/8"	36 5/8"	8"	3	5.5	10 GPM, 650 PSI
10"	10 3/4"	48"	105"	35 3/4"	60"	25	37 1/2"	10"	5	7.5	10 GPM, 1000 PSI
				8" ELEC.	8" HYD.	8" GAS	10" ELEC.	10" HYD	10" GAS		
WEIGHT WITH DRIVE (LBS.)				365	237	335	410	285	395		
WEIGHT NO DRIVE (LBS.)				275	—	300	310	—	320		
				8" ELEC.	8" HYD.	8" GAS	10" ELEC.	10" HYD	10" GAS		
HANDLE FORCE TO BALANCE (LBS.)				40	16	26	45	32	30		

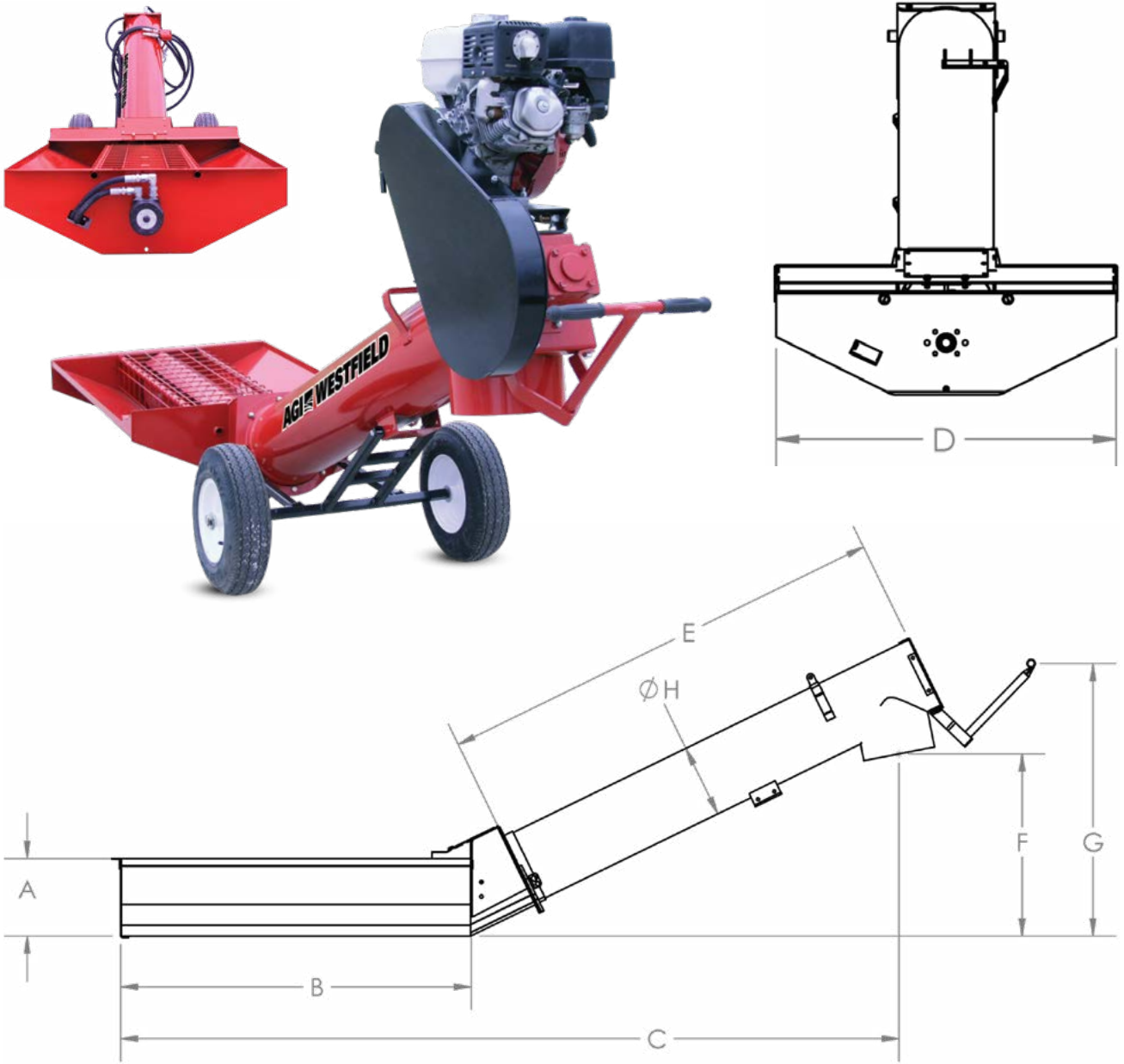

# Utility Augers

Designed for permanent and semi-permanent auger installations, AGI Westfield's Utility Augers provide solutions to your grain handling facilities. These augers are available in 4", 6", 8", 10", and 13" diameters in various lengths and can be used at grain bins and bulk tanks. Electric motor, pulley, and switches not supplied.

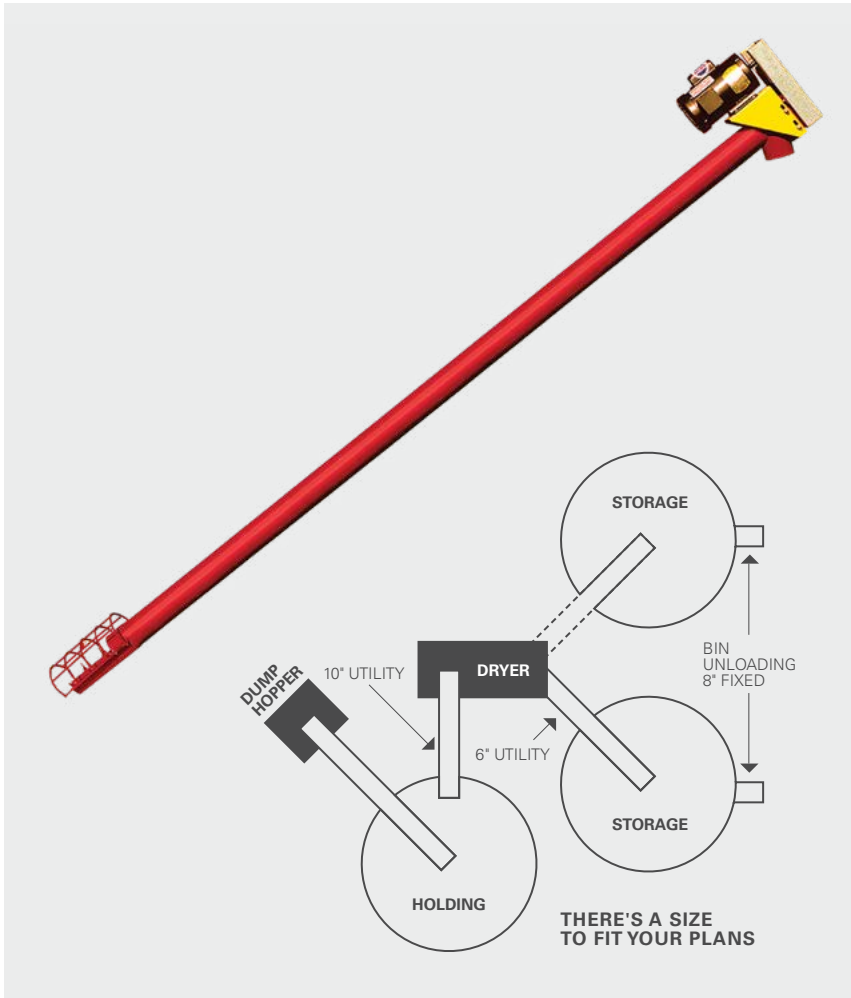

**4"**

BASIC AUGER: 11' | EXTENSION: 5', 10'

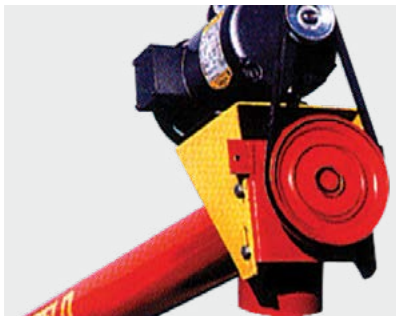

Portable 4" auger, adjustable motor mount, shielded single "A" belt and pulley, and pre-lubricated top end bearing.

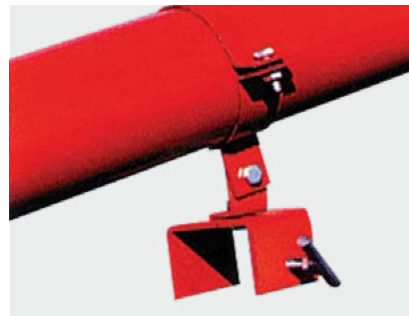

Handy swivel mount bracket for quick mounting to truck box, wagon or feed bin.

**6" 8" 10"** BASIC AUGER: 16' | EXTENSION: 5', 10', 15'

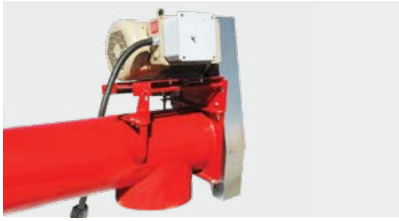

Upper drive has heavy-duty flange ball bearing and adjustable motor mount with double "B" belts and pulley (triple belts on 13" models).

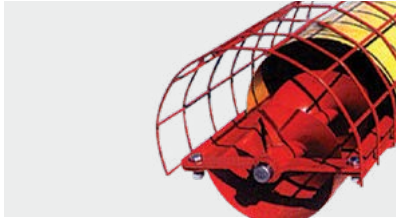

Optional bolt-on flight support bushing with grease fitting (standard on 13" models).

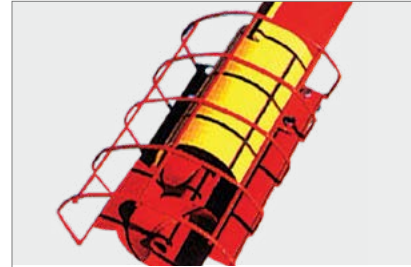

Shielded intake assembly bolts to basic drive section or extension, shown with optional adjustable feed control.

**13"** BASIC AUGER: 21' | EXTENSION: 5', 10', 15'

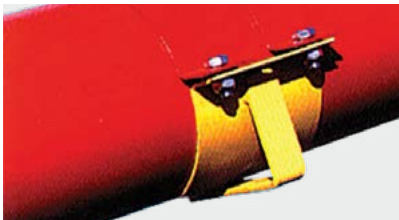

Optional bolt-on tube clamps for attaching support bracing.



Optional handy steel hopper with flight support bearing. Also available with hinged lid for 6" to 10" models.

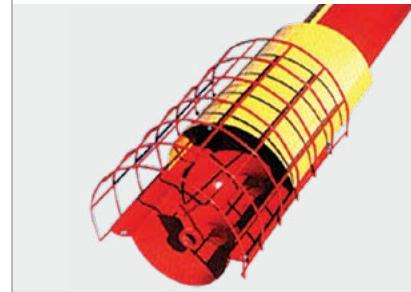

**OTHER OPTIONS**

**Flex Spout | Poly Hopper | Triple Groove Pulley** (comes with 3-belts for long 10" augers)

**SPECIFICATIONS**

	4"	6"	8"	10"	13"
RECOMMENDED PULLEY SIZE FOR 1,750 RPM MOTORS	1A 2" – 2 ¼"	2B 3½" – 4"	2B 3¼" – 3½"	2B 3¼" – 3½"	3B 3¼" – 3½"
FLIGHT SPEED	440" – 490"	480" – 550"	445" – 480"	380" – 410"	355" – 380"
AUGER PULLEY SUPPLIED	1A 8"	2B 12.7"	2B 12.7"	2B 15"	3B 16"
BELT(S) SUPPLIED	1 – A33	2 – B48	2 – B 51	2 – B 62	3 – B 67
EXTENSIONS AVAILABLE	5', 10'	5', 10', 15'	5', 10', 15'	5', 10', 15'	5', 10', 20'
TUBE GAUGE	16 GA	16 GA	14 GA	12 GA	12 GA
FLIGHT GAUGE	13 GA	12 GA	10 GA	7 GA	¼"

Note: For intermittent feed, a slightly smaller pulley will allow easier startup under load.

**HORSEPOWER REQUIREMENTS**

	4"	6"	8"	10"	13"
11'	¾	—	—	—	—
16' – 21'	¾ – 1	1½ – 2	3	3 – 5	10
26' – 31'	1 – 1½	3	5	5 – 7½	15
36' – 41'	1½ – 2	3 – 5	5 – 7½	7½ – 10	20
46' – 51'	2 – 3	5	7½ – 10	10 – 15	—
56' – 61'	—	7½	10	15 – 20	—

\*Requirements above are for dry grain. High moisture grain will require additional horsepower.

**DISCLAIMER:** These augers were proudly designed to handle dry, free-flowing grains up to a maximum density of 65 lb/bu (52 lb/cf). Any usage of this auger outside of this is not authorized by AGI



**WESTFIELD is an AGI Brand.**

AGI is a leading provider of equipment solutions for agriculture bulk commodities including seed, fertilizer, grain, and feed systems with a growing platform in providing equipment and solutions for food processing facilities. AGI has manufacturing facilities in Canada, the United States, the United Kingdom, Brazil, India and Italy and distributes its products globally.

**AGI  WESTFIELD**

198 Commerce Drive, Winnipeg, Manitoba, Canada R3P 0Z6  
1.855.432.1990 | [aggrowth.com/westfield](http://aggrowth.com/westfield)

AGGROWTH.COM    [aggrowthintl](#)                    