



BUSH HOG®
Performance You Can Count On™

HAY TOOLS
DISC MOWERS, TEDDERS AND RAKES



Made
**BUSH
HOG**
TOUGH
in Selma Alabama

HMG SERIES
HAY MOWERS



Bush Hog®'s four models of HMG hay mowers fit a large range of tractor sizes and production requirements. These mowers have Bush Hog's patented cutter bar design ready to handle your toughest mowing areas. These mowers have been performance proven with reduced wrapping and plugging issues in heavy and light hay crops, and as always, they are built Bush Hog tough for years of dependable service!



Field conversion kit from 2 blade disc to 3 blade disc for 6 and 8 disc units only











Cutting height conversion kit for rough areas. Raises cutting height to a maximum of 3 1/2-inches



Optional anti-wear slide

Bush Hog® TOUGH Features

-  **TOUGH four models of HMG hay mowers** fit a large range of tractor sizes and hay production requirements.
-  **TOUGH HMG mowers** have been performance proven with reduced wrapping and plugging issues in heavy and light hay crops.
-  **TOUGH Cutter bar stiffness** is critical in 7 and 8 disc models. The design of the HMG9 and HMG10 bar has a patented design that results in exceptional strength.
-  **TOUGH oval shaped discs** assist in the flow of material over the cutter bar, thus helping to form an even discharge of crop.
-  **TOUGH lifting mower** for turns is accomplished through the use of the mower bar cylinder and without use of the three-point lift.
-  **TOUGH bearings** in the oil bath cutter bar are sealed for reduced contamination and improved performance on inclines.
-  **TOUGH Cutter bar ground pressure** can be adjusted to follow a variety of ground conditions.
-  **TOUGH outer swath board** creates a cleaner space between cuttings, thereby eliminating cut crop overlap.

SPECIFICATIONS

MODELS	HMG7	HMG8	HMG9	HMG10
Mowing Width	6-feet 11-inches	8-feet	9-feet 5-inches	10-feet 6-inches
Number of Discs	5	6	7	8
No. of Blades per Disc	2	2	2	2
Driveline Size	Cat 4	Cat 4	Cat 4	Cat 4
Min. PTO Horsepower	40	45	50	55
Hitch	Cat II	Cat II	Cat II	Cat II
PTO Speed	540 RPM	540 RPM	540 RPM	540 RPM
Safety Curtain	Std	Std	Std	Std
Weight (approximate)	904-lbs.	1100-lbs.	1232-lbs.	1430-lbs.

HT SERIES
HAY TEDDER









HT210



HT417H

For the fastest drying time, choose Bush Hog®'s tedders. We offer a choice of three different models, each built to accommodate your needs. Our tedders are designed for low horsepower tractors, with working widths from 10 to over 25-feet. The Bush Hog® tedder produces quicker drying time for baling sooner and reduces possible damage to ground plants.

Bush Hog® Tough Features

-  **TOUGH Bush Hog® Hay Tedder** for faster hay drying time.
-  **TOUGH Three Models** to choose from.
-  **TOUGH Fluffing and Spreading Cut** hay increases air flow through the crop and results in faster drying times.
-  **TOUGH Six Spring Steel Tines Per Rotor** fluff and spread the hay.
-  **TOUGH Slipclutch** is standard to protect the 540 PTO driveline.
-  **TOUGH Bush Hog® Tedders** were designed for low horsepower tractors.
-  **TOUGH Tine Height** can be adjusted manually for proper performance.



Anti-Wrap Stationary Disc



Clutch Protection

SPECIFICATION

MODEL	HT210	HT417	HT417H	HT419H	HT625H
Number of Rotors	2	4	4	4	6
Working Width (Approx.)	10-feet	17-feet 1-inch	17-feet 1-inch	19-feet	25-feet 7-inches
Number of Tines	12	24	24	24	36
Transport Width	10-feet	10-feet	10-feet	11-feet	9-feet 6-inches
Working Speed (MPH)	5-10	5-10	5-10	5-10	5-10
Horsepower Required (min)	15 HP	22 HP	22 HP	25 HP	50 HP
PTO (RPM)	540 RPM	540 RPM	540 RPM	540 RPM	540 RPM
Folding (man. or hyd.)	N/A	Manual	Hydraulic	Hydraulic	Hydraulic
Tire Size	16 x 6.50-8				16 x 6.50-8 (Working Tires) 205/70/15 (Transport Tires)
Number of Tires	2	4	4	4	8 (Working Tires) 2 (Transport Tires)
Weight	385-lbs.	830-lbs.	850-lbs.	1,225-lbs.	2,470-lbs.
Options	Hydraulic Tilt Kit				

EWR SERIES

WHEEL DRIVEN RAKES



Shown with optional center wheel

Our EWR Series Wheel Hay Rakes are designed to make your harvesting faster, easier, and more efficient. With raking widths from 20 to 23-feet, all our hay rakes are built to provide unrivaled performance in the toughest conditions, season after season. No matter the size, Bush Hog® has the dependability and range for your specific needs. When you need to rake a perfect swath, nothing beats a Bush Hog® for performance you can count on!

Bush Hog® TOUGH Features

- 🐾 **TOUGH EWR Wheel “V” Rakes** are available in 8 and 10 wheel models.
- 🐾 **TOUGH Standard Lift Cylinder** allows easy transport in the narrow, folded position.
- 🐾 **TOUGH Adjustable Wheel Load Pressure** ensures correct ground contact for maximum raking performance.
- 🐾 **TOUGH Optional Center Wheel** kit fluffs center of windrow for quality hay.
- 🐾 **TOUGH Adjustable Windrow Width** to match baler.
- 🐾 **TOUGH Standard 195-70/15 Tires** provide maximum stability.
- 🐾 **TOUGH EWR Wheel Rakes** are budget sensitive while delivering quality performance.



Adjustable windrow width

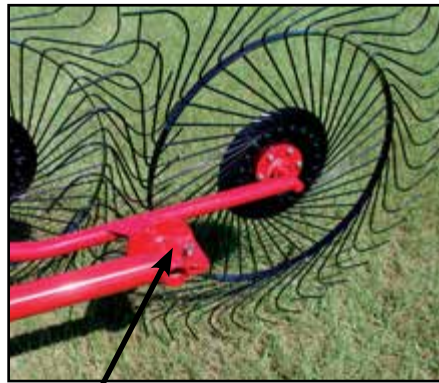

Wheel flotation for uneven ground



Spring adjustment for finger wheel ground pressure

SPECIFICATION		
MODEL	EWR820	EWR1023
Number of Finger Wheels	8	10
Total Length	17-feet 5-inches	20-feet 3-inches
Window Width, Adjustable	3-feet to 5-feet	3-feet to 5-feet
Working Width	20-feet	23-feet
Transport Width	10-feet	10-feet
Minimum Tractor H.P. Required	30 HP	30 HP
Tire Size	195-70R/15	
Operating Speed	Up to 14 MPH	
Approximate Weight	1,200-lbs.	1,355-lbs.

BSR SERIES

LIFT WHEEL RAKES



The BSR wheel rakes manufactured by Bush Hog® are ideal for all conditions especially in rough or unlevel hay fields. Each independently suspended wheel operates separately from its adjacent wheel, thereby giving excellent performance in all conditions. The high ground clearance of the main frame allows for high performance in heavy crop surplus, and each finger wheel has an independent spring suspension that allows it to follow field ground contours across large lots. And as always, our models are built tough for dependable service and performance you can count on!

Bush Hog® TOUGH Features

- TOUGH BSR Wheel Rakes** manufactured by Bush Hog® are ideal for all conditions especially in rough or unlevel hay fields. Each independently suspended wheel operates separately from its adjacent wheel, thereby giving excellent performance in all conditions.
- TOUGH Independently Suspended Wheel** operates at the correct ground load contact without influence of the adjacent wheel. This allows each wheel to follow the ground contours.
- TOUGH High Ground Clearance** of the main frame allows for high performance in heavy crop conditions.
- TOUGH Leading Wheel** on each side of the BSR10 and BSR12 can be raised when there is a need to reduce the windrow volume because of extremely heavy conditions.



Each finger wheel has an independent spring suspension that allows it to follow field ground contours.



An anti-wrap seal protector on the backside of each finger wheel hub adds more protection for the seal and bearing.

SPECIFICATIONS

MODEL	BSR8	BSR10	BSR12
Number of Finger Wheels	8	10	12
Transport Width	11-feet	11-feet 4-inches	11-feet 6-inches
Minimum Working Width*	16-feet 9-inches	17-feet 8-inches	19-feet 9-inches
Maximum Working Width*	19-feet	20-feet 8-inches	24-feet 2-inches
Minimum Windrow Width*	32-inches		
Maximum Windrow Width*	83-inches		
Weight	1950-lbs.	2100-lbs.	2450-lbs.
Tire size	205/75/15		
Tractor H.P. Requirements (min)	30 HP	30 HP	50 HP

* Depending on Crop Conditions

3-POINT HAY IMPLEMENTS



3PBS1 3-PT Single Probe Bale Spear for Cat I Standard and Quick Hitch

3PBS2 3-PT Single Probe Bale Spear for Cat I & II Standard and Quick Hitch

3PBU-XX 3-PT Bale Unroller Cat I & II Standard and Quick Hitch
 To maximize the utilization of your hay crop you can't just set the bale out in the middle of the field, you need to unroll it. 3-PT bale unrollers grasp the hay bale in the center of both sides, and turn on a central axis allowing the friction from the ground to "grab" the hay and start unrolling the bale. The bale unroller simply connects to the back of your tractor and allows you to roll out your hay bales like a carpet, no pitchfork required. The 3-PT Hay Handler/Unroller is rated at 2000-lbs. for 25-45 HP tractors. The bales may be either 4-feet or 5-feet in width and up to 6-feet in diameter. The hydraulic cylinder is included. The unit's arms are powder coated with a durable black paint, while the unit's body is available in major tractor colors to give lasting protective finish. The unit fits both Standard and Quick Hitches.

BALE SPEARS

An effective way to move or stack hay bales is with these economical 3-PT Bale Spears for handling round bales up to 2000-lbs. The units feature a main tapered spear 42-inches long and 2 welded balance spears. They are designed for 25-45 HP tractors to efficiently move hay bales without a loader. In combination with a loader on the front, the operator's efficiency is greatly improved. The units are powder coated with a durable black paint to give lasting protective finish. Each unit fits both Standard and Quick Hitches.

3PBS1/3PBS2

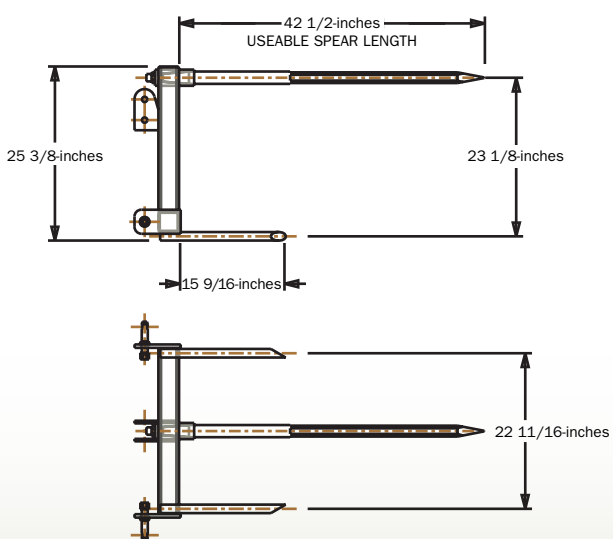

SPECIFICATIONS

Model	3PBS1	3PBS2	3PBU
Description	Bale Spear	Bale Spear	Bale Unroller
Hitch Type	Cat. I, Standard & Quick Hitch	Cat. I & II, Standard & Quick Hitch	Cat. I & II, Standard & Quick Hitch
Overall width	31 7/8-inches	39-inches	69 1/2-inches
Overall height	25 3/8-inches	25 3/8-inches	25 9/16-inches
Horsepower	25-45 HP	25-45 HP	25-45 HP
Weight	80-lbs.	97-lbs.	326-lbs.
Max Implement capacity	2000-lbs.	2000-lbs.	2000-lbs.

BS SERIES

TRACTOR-MOUNTED BALE SPEAR

Built To Last.





The BS2 is a dual spear design. This design allows the moving of large bales with greater speed and stability while using a skid steer or Ag loader.

The BS1 model is a single main spear model. You can transport large round bales easily using a skid steer or Ag loader.



Bush Hog® BS series bale spears are built Bush Hog® tough. With a lift capacity of 3,500 pounds and capable of being mounted on a universal skid steer frame, these bale spears are designed to lift, transport and stack round or square bales of hay or other organic matter. Let Bush Hog®'s BS series bale spears help you get your work done faster.

Bush Hog® Tough Features

-  **TOUGH Spear Capacity** is 3,500-lbs. at 23 1/2-inches from frame
-  **TOUGH 42 1/2-inches Usable Spear Length**
-  **TOUGH Tubular Construction** with solid welding at all joints.
-  **TOUGH Models** are compatible with Skid Steer, John Deere and Euro Quick Attach Systems

SPECIFICATIONS		
Model	BS1	BS2
Overall Height	21 3/16-inches	30-inches
Overall Width	45 5/16-inches	46 5/16-inches
Overall Depth	51-inches	51-inches
Spear Size	1 25/32-inches	1 25/32-inches
Useable Spear Length	42 1/2-inches	42 1/2-inches
Weight	144-lbs.	304-lbs.
Max. Spear Capacity	3500-lbs. @ 23 1/2-inches	
Attachment Method	Universal Skid Steer Quick Attach, Euro or John Deere	
Color	Black	Black

Made
BUSH
HOG
TOUGH
in Selma Alabama



2501 Griffin Ave.
Selma, Alabama 36703
Tel: (800) 363-6096
Fax: (334) 874-2701

www.bushhog.com