

**INSTRUCTION MANUAL**



**ERL-3**

**ROTARY HARROW**



# CONGRATULATIONS

Dear Owner,

Thank you for buying a SOVEMA manufactured product.

Your new machine is carefully designed and manufactured to give you superior performance and dependable service, if properly operated and maintained.

You will find this machine to be rugged and reliable when matched to the suggested horsepower operating range.

Much time has been invested in providing safety and protection. Please carefully read this manual. It tells you how to safely and easily assemble, operate and maintain your machine.

Be sure that you and any other operator carefully follow the recommended safety practices at all times. Failure to do so could result in personal injury or property damage.

Of course, if you should ever have any problems or questions, please contact your local SOVEMA dealer or contact us at the addresses or numbers indicated in this manual.

SOVEMA manufactures a variety of innovative equipment. If you are interested in reviewing our full line, please contact us.

Thanks for your choice.

Ginettino Mayer  
President

# TABLE OF CONTENTS

- SYMBOLS	Page 3
- GENERAL INFORMATION	Page 4
- SAFETY AND WARNING DECALS	Page 5
- SAFETY INSTRUCTIONS	Page 7
- MAIN CHECK	Page 10
- TECHNICAL SPECIFICATIONS	Page 11
- ATTACHING THE MACHINE TO THE TRACTOR	Page 12
- CUTTING HEIGHT ADJUSTMENT	Page 16
- BEGINNING WORK	Page 17
- TROUBLE SHOOTING	Page 18
- DISCONNECTING THE MACHINE FROM THE TRACTOR	Page 20
- STORING OF THE MACHINE	Page 21
- MAINTENANCE	Page 22
- TOXICOLOGICAL INFORMATION	Page 25
- PARTS LIST	Page 27
- WARRANTY POLICY	Page 34
- SOVEMA PRODUCT LINE	Page 38

# SYMBOLS

These symbols appear throughout the manual.  
Remember their meaning and advice.



**MEANS: CAUTION!  
YOUR SAFETY IS INVOLVED**

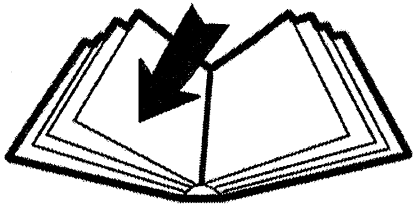

**MEANS: READ CAREFULLY**

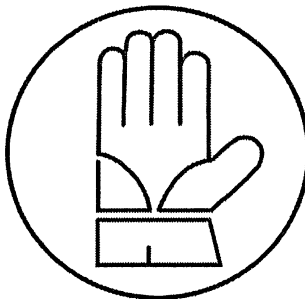

**MEANS: USE PROTECTIVE GLOVES**

# GENERAL INFORMATION

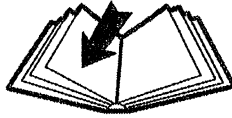

All implements with moving parts are potentially hazardous. The manufacturer has designed the implement to be used with all the safety equipment properly attached. The purpose of this manual is to assist you in safely maintaining and operating the implement.

These instructions have been compiled from our experience. Through this experience and these instructions, you should be able to develop operating procedures suitable to your particular situation.

Illustrations and data used in this manual may vary slightly in some details. Throughout this manual references are made in left and right directions. These are determined by standing at the rear of the equipment and facing the direction of forward travel.

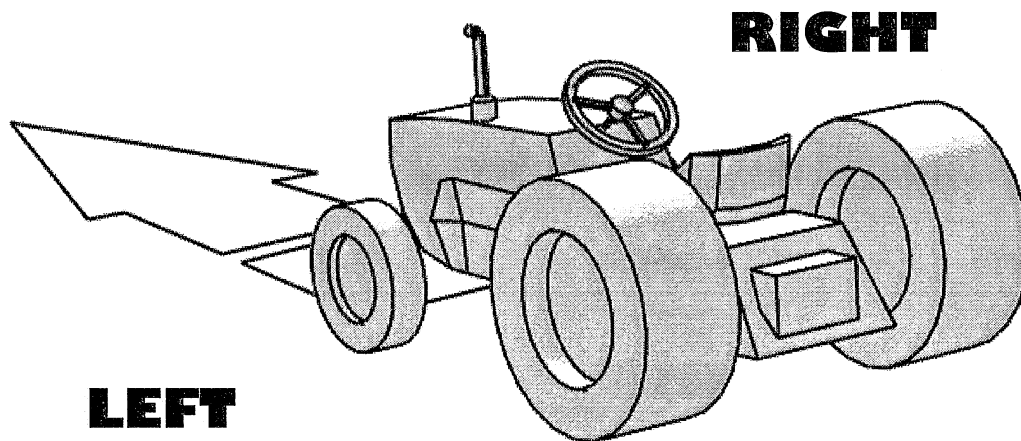

Even if some illustrations in this manual show the machine with safety shields removed for a better view, never operate in these conditions.

**BEFORE OPERATING THE IMPLEMENT, ALL SAFETY SHIELDS OR DEVICES MUST BE MOUNTED**

# SAFETY AND WARNING DECALS

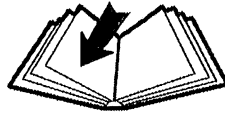

Safety decals on the implement contain important safety warning messages. To prevent injuries we invite the operator to read them carefully and keep them clear. Check that all the decals are on the machine. If not, **DO NOT USE** the machine and report to the Dealer immediately to get the decals. Decals on the machine are the following and mean:

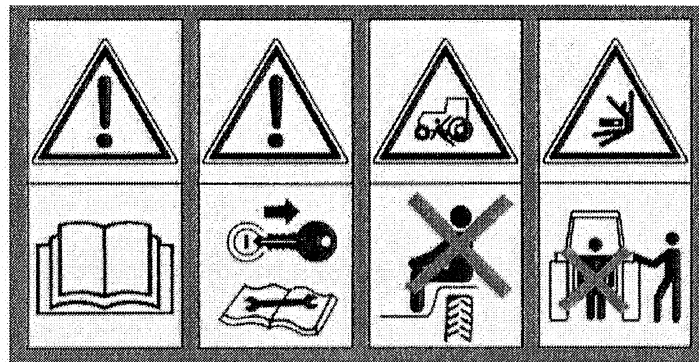

1

2

3

4



1. Before operating the equipment, read carefully the operator's manual.



2. Before maintenance operation, lower the implement, shut off the engine and read the operator's manual.



3. Do not allow riders on tractor or implement.



4. Do not stand behind the tractor during the operations.

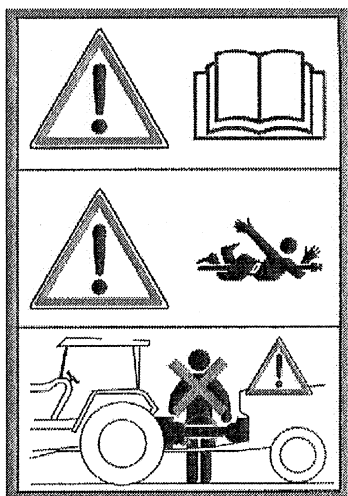

5. Before operating the equipment, read carefully the operator's manual.



6. DANGER! Entanglement of driveline..



7. KEEP AWAY from driveline in operation: contact can cause death!

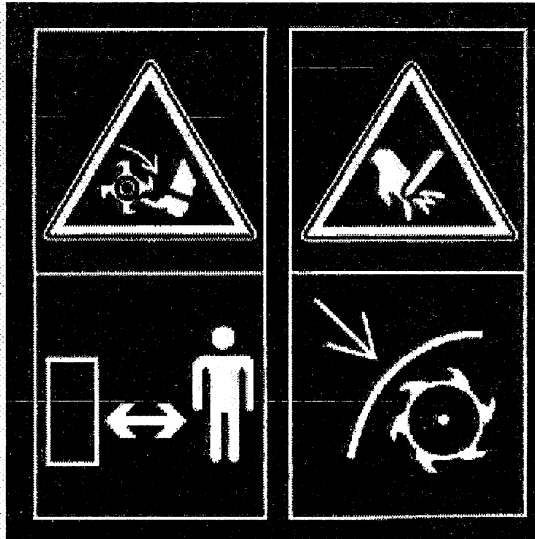

8

9



8. Danger. Your feet can be injured. Keep away from the implement.



9. Danger. Your hands can be injured. Do not remove safety protection and keep away from moving parts.

**540 rpm**



10. The machine is designed for use on tractors with 540 RPM PTO only.

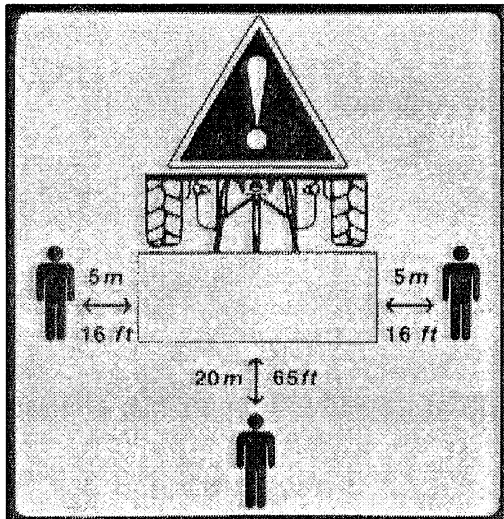

11. Caution! During working operations all bystanders must stay beyond the shown distances from the implement.









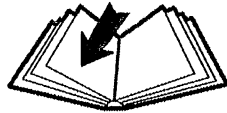



# SAFETY INSTRUCTIONS



Before using the implement you must be sure to know the main safety precautions; in fact many accidents are caused by not observing these rules.



## Pre-operational and operational safety rules

-  Make sure that no person operates this machine unless they first, thoroughly read and studied the operator instructions for this machine and understood all the safety precautions.
-  Keep all guards, shields and safety decals in place and proper working order before operating this machine.
-  Operate only with a tractor equipped with an approved Roll Over Protective System (ROPS) and always wear your seat-belt.
-  Operate only in daylight or good artificial light.
-  Only trained personnel can operate with the tractor and the implement.
-  **Personal protection equipment**, including safety shoes, safety glasses, hard hat and gloves are recommended during the different operations. Do not allow long hair, loose fitting clothing or jewellery to be around moving parts.
-  Do not leave the tractor seat until the engine is completely **turned off, brakes locked** and **ignition key removed**.
-  Do not allow riders on the machine or tractor at any time. No safe place for any rider.
-  Before starting to operate, be sure that the tractor's PTO is set to match the PTO requirements of the implement. The speed is indicated in this manual and on the implement.
-  Do not use different driveline . Always use type and size supplied by the manufacturer.
-  Make sure driveline spring-activated locking pin operate freely and are seated firmly in tractor PTO stub shaft groove.



For engaging or disengaging the tractor PTO, refer to your tractor manual.



Connect and disconnect PTO shaft only when tractor engine is turned off.



Keep hands, feet, hair and clothing away from moving parts.



To prevent injury by thrown objects DO NOT operate unless all personnel, livestock and pets are 20 m (65 ft) away.



The rotating parts of the machine have been designed and tested for rugged use. However they could fail upon impact with heavy solid objects. Such impact could cause the broken objects to be thrown outward at very high speed. To reduce the possibility of serious injury, or even death, never allow the rotating parts to contact such obstacles.



Stop the machine and tractor immediately upon striking an obstruction. Turn engine off, remove key, inspect and repair any damage before resuming operation.



No repairs or adjustments should be attempted while the machine is attached to a tractor that is turned on.



Working inclination of PTO driveline must not exceed 25° (see fig.1). Greater working angles will damage the PTO and serious personal injury could occur as well.

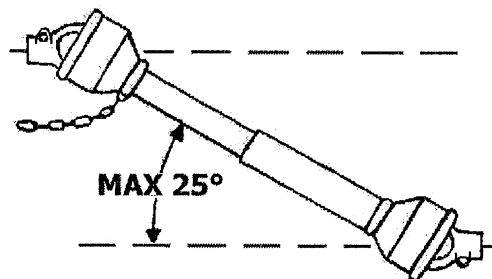

Disengage tractor PTO and place transmission into neutral before attempting to start engine.

## Transport safety



Plan your route to avoid heavy traffic.



For public roads, comply with state and local safety and movement rules.



Be sure that the implement is in the raised position for transport.



When you must drive, do not drink.



Pay attention to traffic when operating near or crossing roadways.



Reduce speed when transporting mounted implement to avoid bouncing and loss of steering control.



Pay attention when you turn curves or you go up and down on hills with the implement. Be sure that at least 25% of the tractor's weight is on the front wheels to maintain safe steering. Drive at a low speed.



NEVER allow riders on implement or tractor. Falling off can kill.



Be a safe and courteous driver.

## Maintenance safety



Good maintenance is your responsibility. Poor maintenance is an invitation to trouble.

**For maintenance follow these common practises:**



- keep service area clean;
- use adequate illumination for the job;
- be sure tools and electrical outlets are properly grounded;
- make sure there is plenty of ventilation.



Before making maintenance on this machine, drive to a level area, disengage the PTO, lower the machine, turn off the engine, set the brakes and remove the ignition key.



Keep all persons away from operator control area while performing maintenance.



ALWAYS use personal protection devices.



Periodically tighten all bolts, nuts and screws.



The implement manufacturer assumes no liability if replacement parts other than the original factory parts are used.



After servicing, be sure that all safety shields are re-installed properly.



Be sure that all safety decals are installed, clean and in good condition.



If the machine is modified from the original design, no responsibility for the manufacturer can be claimed.

# MAIN CHECK LIST

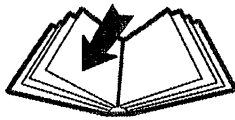

Before connecting the machine to the tractor, read the following instructions:

- Be sure the weight and power of the tractor is correct with the machine you want to connect. If you have any doubt, see the technical specifications.

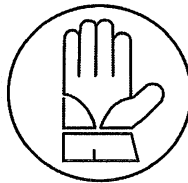

- Ensure that all safety decals are properly installed and clean.
- Check oil in the gearbox. With low oil, gears get damaged.
- Check grease level in the box containing the gears. Insufficient lubrication takes to brake one or more tooth of the gears.
- Be sure that all safety shielding is properly installed and in good condition.

# TECHNICAL SPECIFICATIONS



The machine described in this manual is an **ERL-3 series**.

## ERL-3 SERIES

MOD.	Working width		Working positions		Working depth		HP	Rotor	Weight		N° Knives
	cm	inches	Sx cm/inches	Dx cm/inches	cm	inches		rpm	Kg	Lbs	
<b>ERL-3 110</b>	110	44"	55/22"	55/22"	27	11"	25 - 35	261	352	774	10
<b>ERL-3 130</b>	130	52"	65/26"	65/26"	27	11"	30 - 40	261	372	818	12
<b>ERL-3 150</b>	150	60"	75/30"	75/30"	27	11"	35 - 45	261	400	880	14
<b>ERL-3 170</b>	170	68"	85/34"	85/34"	27	11"	40 - 55	261	434	955	16
<b>ERL-3 190</b>	190	76"	95/38"	95/38"	27	11"	45 - 60	261	470	1034	18
<b>ERL-3 210</b>	210	84"	105/42"	105/42"	27	11"	50 - 60	261	504	1109	20
<b>ERL-3 230</b>	230	92"	115/46"	115/46"	27	11"	50 - 65	261	536	1179	22

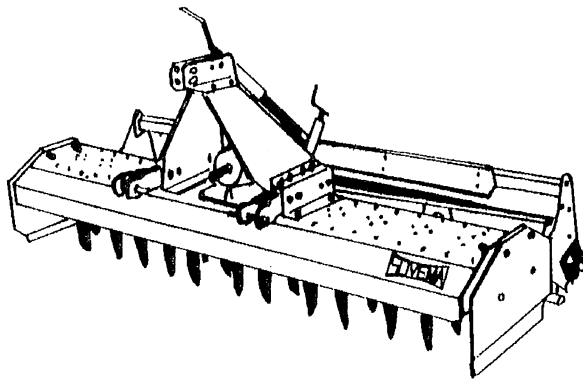

## LEVEL OF NOISE WHEN IDLING

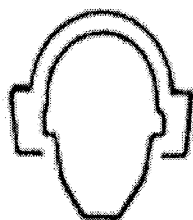

**L<sub>pa</sub> (A) 84 dB MAX**

# ATTACHING THE MACHINE TO THE TRACTOR



The machines described in this manual do apply to any kind of tractor provided of universal third hitch point.

The characteristics (length, diameter of the holes for the lifting pins) of the tractor's lifting arms depend on the type of tractor utilized, therefore it is necessary to prepare the machine in order to conclude the attachment correctly.

Before attaching the machine to the tractor you must be sure that the engine is shut off, brakes are locked and the ignition key is removed.

This operation must be made on a flat area as it is very dangerous.



Do not allow anyone between tractor and the machine when the engine is running.

Follow these instructions:



Connect the hitch of the drawbar to the tractor using a hitch pin and the hair clip pin (see fig. 1).

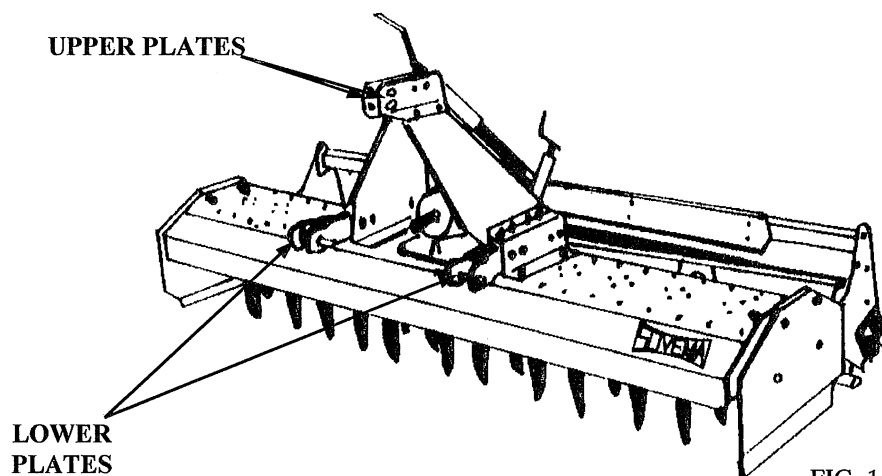

FIG. 1



Connect the third point of the tractor to the upper plates of the machine using a hitch pin and the hair clip pin (see fig. 1). By means of the tie rod of the hitch point, which permits regulation of the machine's inclination, set the machine even to ground-floor (see fig. 3). This procedure extends life time of the PTO shaft and the machine.



Graft the PTO Shaft and be sure it is correctly fixed to the tractor and machine.

## Shortening the PTO shaft

Due to the many different types of tractors, it may be necessary to shorten the PTO shaft.



Always refer to the manual of the driveline's manufactures. Read it carefully.



In case shortening is needed, listed below are some basic guidelines on performing this modification. Determine how much length is to be removed, then:

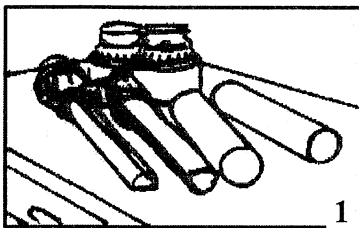
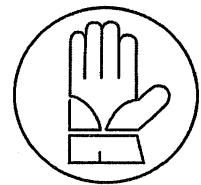

1) Remove plastic protection (both sections)

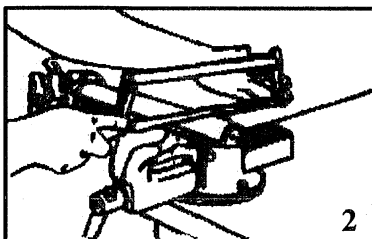

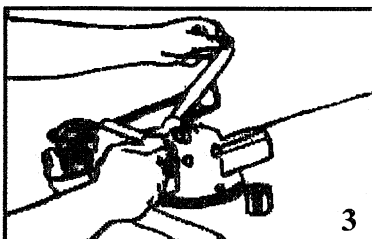

2) Cut the excess length of both tubes



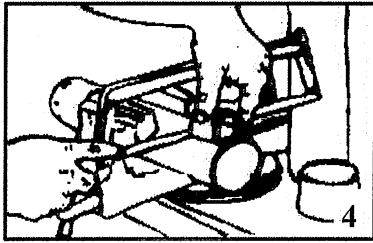

3) Deburr and clean the saw-dust off ends of tubes. Remove packing inside shaft tubing



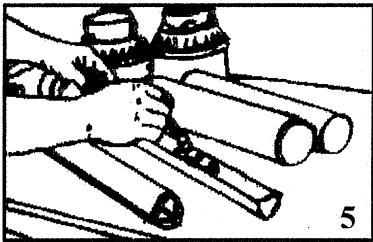

-  4) Cut the plastic protection to the same length you have cut the joints



-  5) Grease the male joint section and reassemble protection



Do not use PTO shafts without proper shielding installed.

# DEPTH CONTROL

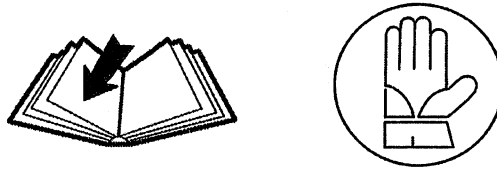

To set the machine's working depth, adjust the rear roller rotating the crank of its register screw, as in figure 1:

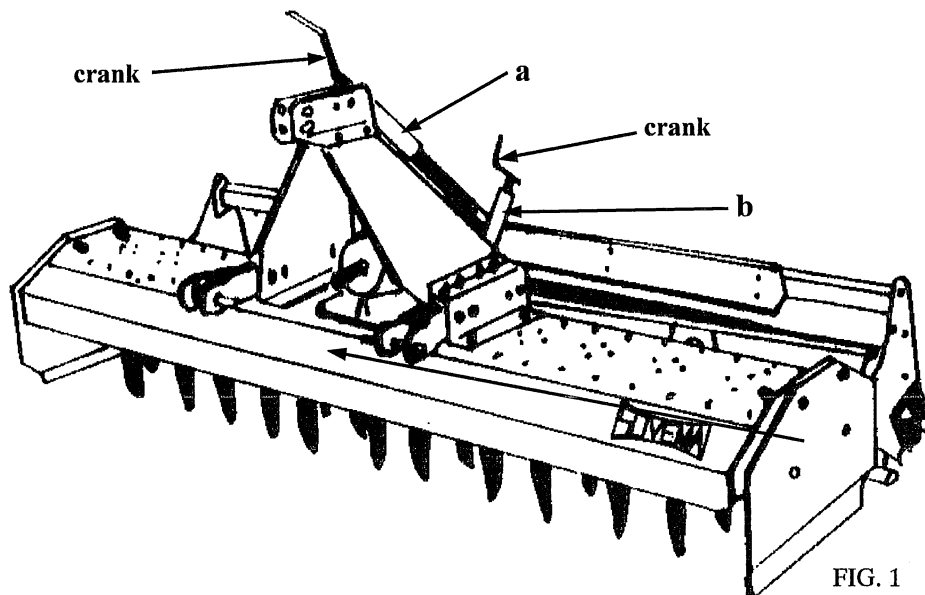

FIG. 1

After regulating the rear roller it is necessary to regulate the position of the level bar as follows (see fig. 2):

- Unblock the screw register crank (b of fig. 1) of the level bar by taking out the stop mechanism of the crank itself;
- Rotate the crank until the level bar arrives to the desired position;
- Block the crank using the stop mechanism.

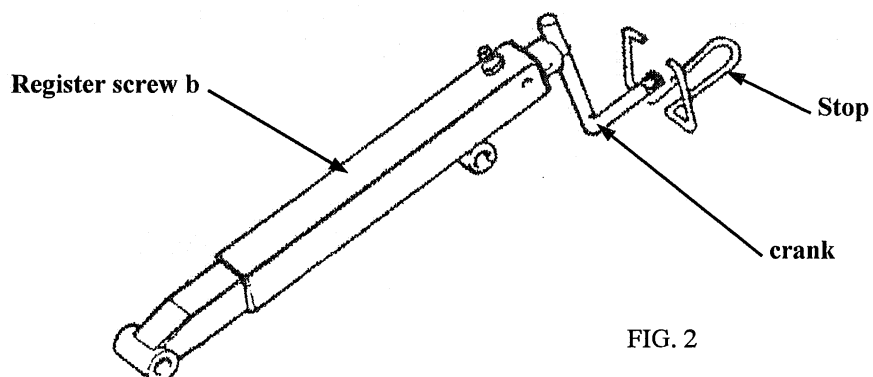
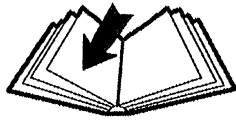

FIG. 2

# BEGINNING WORK



After completing all safety controls, to avoid damage start as follows:

- Raise the machine off the ground in order to let the blades start moving without touching ground.
- Maintaining the machine raised, engage the tractor PTO at suggested engine RPM.
- Start moving the tractor forward and then gradually lower the machine.



Ground speed of the machine, while working, must not exceed 5 km/h.

## TIPS TO GET DESIRED RESULTS

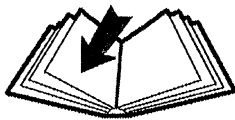

While operating, to avoid damage do not attempt to make turns and do not absolutely go backwards. Disengage the machine and raise it off the ground when making turns and U turns.

# TROUBLE SHOOTING



During work several problems can happen:

## Unusual noise

While working, if the **machine** made **unusual noise**, the operator must **stop it immediately** and follow next instructions:

- **Check for broken/bent parts.**
- **Check for correct oil level in the gearbox.**

When present incorrect oil level (see chapter on maintenance), the gears of the gearbox are not lubricated correctly, and if continue to rotate, would determine a significant **increase in oil temperature**. If continue working in this condition **will quickly take to damage gear bearings**.

- **Check the lubrication of the gears contained in the box.**

As a result of inadequate lubrication (see chapter relative to Maintenance), damage of one of the tooth of the gears is possible, taking it to brake in short time. Continuing to work in this way takes in short time to block the transmission.

- **Check the lubrication and condition of the bearings that support the rotor shaft hubs.**

As a result of inadequate lubrication (see chapter relative to Maintenance) of one or both of the bearings that support each of the rotor shafts, bearings itself brake, and in short time take to block the transmission.

Another possible cause that take to brake the bearings is the improper use of the machine as a result of using it at high speed, changes on direction, u-turns while working, or working in terrain particularly stony.

## Problem with uniformity on result

While operating, if you notice that work is not uniform, stop the machine and check that **no object has been trapped** in the rotor shafts or in the knives it selves.









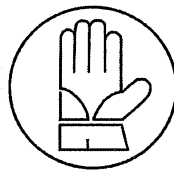

Before checking the machine to find the possible cause of the problem, be sure the tractor's PTO is disconnected, tractor's engine turned off, brakes on, key ignition off the command board, and the machine completely lowered to the ground.

# DISCONNECTING THE MACHINE FROM THE TRACTOR



Disconnection of the machine must be carried out on flat area, and it is considered a very dangerous operation. You must pay attention. Follow these instructions:



-  While remaining in the tractor seat, put the tractor PTO in neutral.
-  When rotors are completely stopped, turn off the engine and set the parking brakes.
-  Remove the ignition key.
-  Descend from the tractor and disconnect the driveline.
-  If you have an hydraulic fold machine, disconnect hydraulic hoses from the tractor.
-  Engage the parking stand.
-  Disconnect the hitch of the drawbar from the tractor.



Before disconnecting the driveline, be sure the tractor PTO is in neutral and engine is off.

# STORING OF THE MACHINE

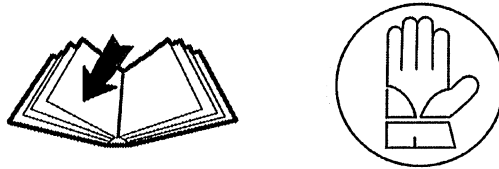

As your machine is an investment and if remains unused for a long period, we suggest the following procedures:

- Wash and dry the machine;
- Check all moving parts; for excessive wear replace the parts or contact your local dealer;
- Check bolts and nuts for proper tightness, in particular those that fix the knives;
- Grease the two bearings of each shaft;
- Grease the gears contained in the box;
- Grease the supports of the rear roller;
- Grease the register screw of the rear roller;
- Grease the register screw of the level bar,
- Lubricate and protect all not-painted parts;
- Store the machine in a clean and dry place under roof.

# MAINTENANCE

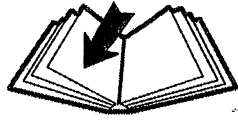

For long life of your machine and trouble free operation, regular program of maintenance is required.

The recommended phases of maintenance are for normal use and can be varied depending on the different conditions.



Always disengage tractor PTO before starting maintenance.



## Every 10 working hours

- Check for loose bolts that fix the blades to the rotor. Tighten as needed (see fig. 1).
- Grease the PTO shaft components.
- Clean the end of PTO shaft with non toxic / non inflammable detergent.
- Be sure that driveline shields are in place and in good condition.
- Grease the two bearings of each rotor shaft through its relative grease nipple located on the lid of the machine (see fig. 1). Proceed after cleaning each grease nipple for more efficient lubrication. Use lithium grease type: NLGI 2.



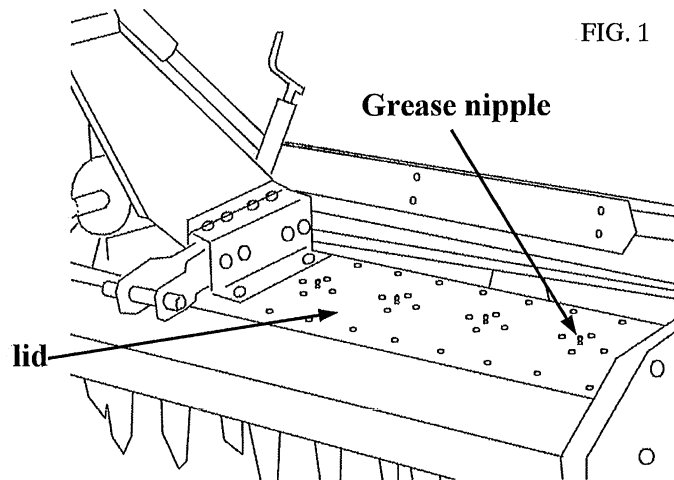

- Clean the machine.

### Every 50 working hours

- Check blades for wear. Replace if necessary. Use only original parts.
- Make sure PTO shaft and slip clutch are in place and in good condition. If damaged or worn, replace slip discs. Contact your local dealer for substitution.
- Check gearbox oil level by unscrewing the filler plug, located on top of the box, and controlling that the metallic rod, with which the plug is provided, is wet of oil for a height no less than 15 mm (see fig. 2 and 3). If height is inferior to 15 mm, provide immediately to refill with new oil.

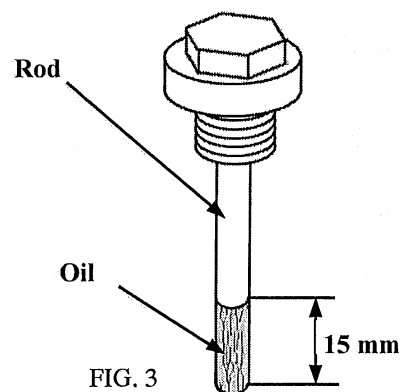
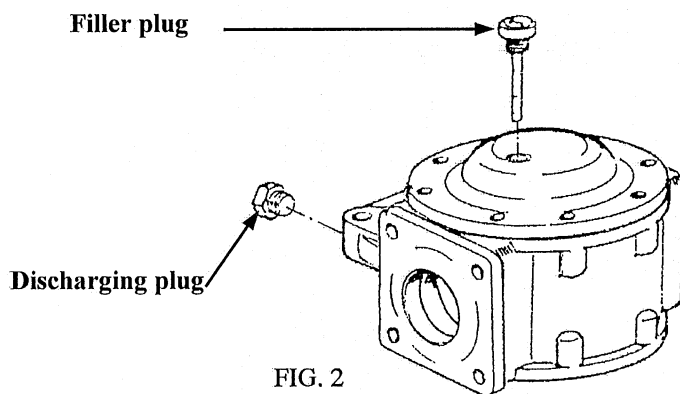

Check the level of grease in the case containing the gears. Follow instructions (see fig. 4):

A. Unscrew the filler plug for grease located on top of the lid, near the gearbox;

B. Insert a metallic rod vertically in the case, through the filler hole until touching the bottom of the case itself.

C. Take out the rod from the case and be sure the rod results wet of grease for a height no less than 30 mm.

If height is inferior to 30 mm, provide immediately to add oil. Use lithium grease type: EP 1.

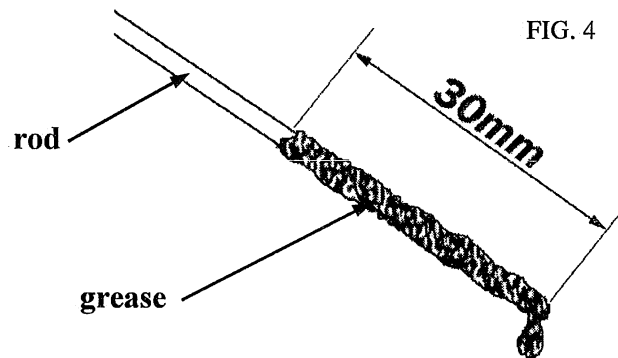

- Grease the two lateral supports of the rear roller, after cleaning correctly the grease nipples for better lubrication. Use lithium type grease NLGI 2 .
- Grease the register screw of the rear roller (fig. 5), after cleaning correctly the grease nipples for better lubrication. Use lithium type grease NLGI 2 .
- Grease the register screw of the level bar (fig. 6), after cleaning correctly the grease nipple for better lubrication. Use lithium type grease NLGI 2 .

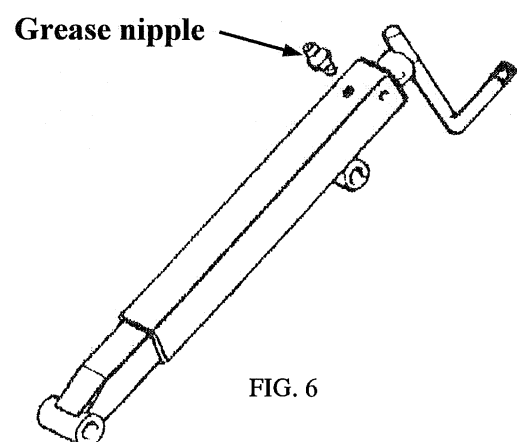
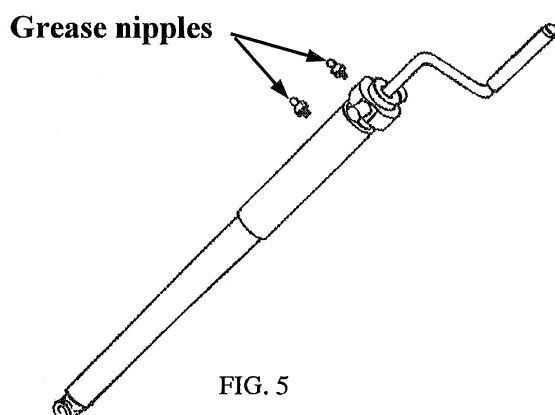

**First 100 working hours**

In the case the machine has done its first 100 hours, it is necessary to completely change the oil from the gearbox. To proceed, discharge all the oil through the discharging hole located in the lateral side of the box after opportunely leaning the machine. Then fill in the box with new oil through the filler hole. This substitution is necessary because the gears are new and so are subject to quicker worn. Use oil: SAE 80 W 90 API GL 4.

**Every 300 working hours**

Completely change oil of the gearbox as explained before. Use oil: SAE 80 W 90 API GL 4.

# TOXICOLOGICAL INFORMATION ABOUT LUBRICANTS



	TYPES OF DANGER	PROTECTIVE EQUIPMENT	PRIMARY INTERVENTION
<b>SKIN</b>	Possible irritation after prolonged contact	Gloves and/or lotion barrier	Wash with soap & water
<b>EYES</b>	Possible irritation on contact	Protective goggles	Rinse thoroughly w/ running water
<b>INHALATION</b>	Possible irritation after prolonged exposure	Maintain an oil mist level of 5mg/m <sup>3</sup> between TLV-TWA limits	Expose to fresh air and call medical assistance immediately
<b>INGESTION</b>	Such possibility not considered		DO NOT provoke vomiting; call medical assistance immediately

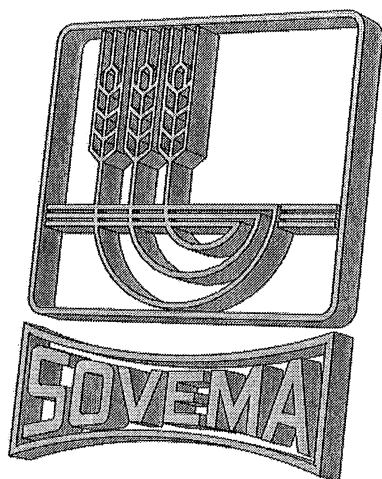

**USE EXCLUSIVELY  
ORIGINAL SPARE PARTS  
FROM**

# SPARE PARTS LIST

## ERX-3 Model

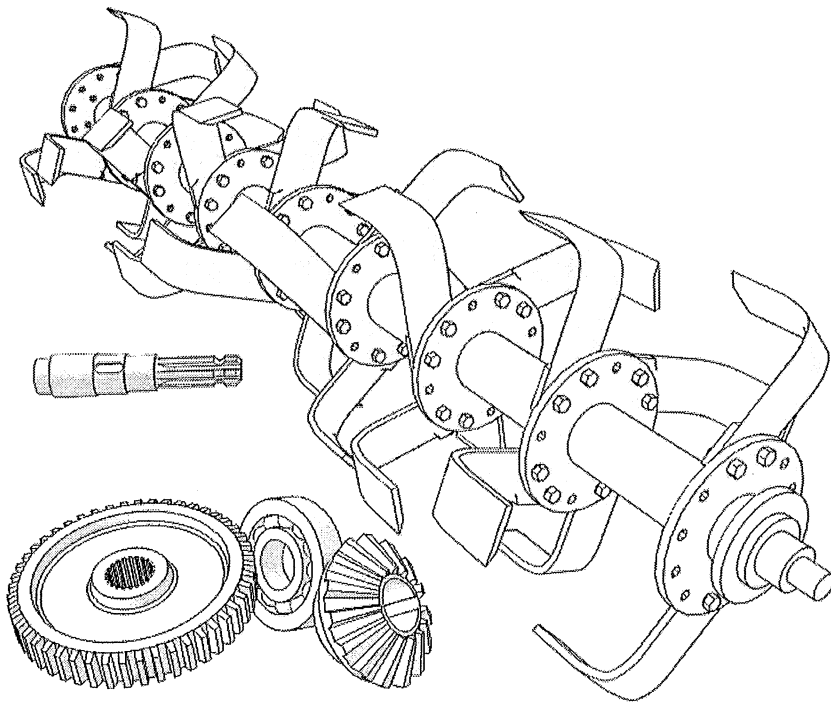

# ERL 3

## Frame

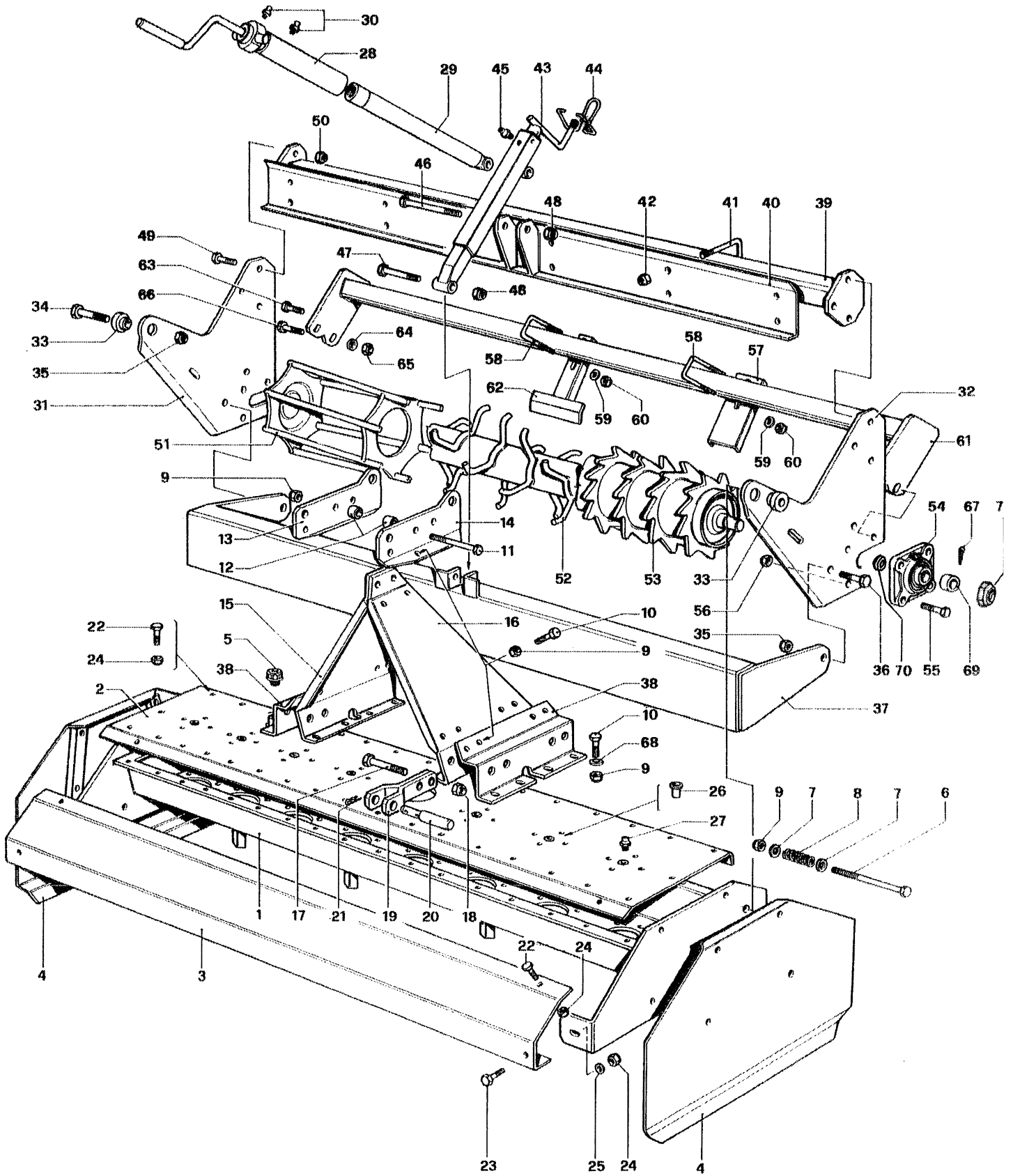

REF	CODE	QTY	ENGLISH	FRANÇAIS	ITALIANO	DEUTSCH	ESPAÑOL	NOTE
1	900.212.051	1	CASE	CAISSE	CASSA	KISTE	CAJA	110
1	900.212.052	1	CASE	CAISSE	CASSA	KISTE	CAJA	130
1	900.212.053	1	CASE	CAISSE	CASSA	KISTE	CAJA	150
1	900.212.054	1	CASE	CAISSE	CASSA	KISTE	CAJA	170
1	900.212.055	1	CASE	CAISSE	CASSA	KISTE	CAJA	190
1	900.212.056	1	CASE	CAISSE	CASSA	KISTE	CAJA	210
1	900.212.057	1	CASE	CAISSE	CASSA	KISTE	CAJA	230
1	900.212.058	1	CASE	CAISSE	CASSA	KISTE	CAJA	250
2	900.212.060	1	LID	COUVERCLE	COPERCHIO	DECKEL	TAPA	110
2	900.212.061	1	LID	COUVERCLE	COPERCHIO	DECKEL	TAPA	130
2	900.212.062	1	LID	COUVERCLE	COPERCHIO	DECKEL	TAPA	150
2	900.212.063	1	LID	COUVERCLE	COPERCHIO	DECKEL	TAPA	170
2	900.212.064	1	LID	COUVERCLE	COPERCHIO	DECKEL	TAPA	190
2	900.212.065	1	LID	COUVERCLE	COPERCHIO	DECKEL	TAPA	210
2	900.212.066	1	LID	COUVERCLE	COPERCHIO	DECKEL	TAPA	230
2	900.212.067	1	LID	COUVERCLE	COPERCHIO	DECKEL	TAPA	250
3	900.212.085	1	GUARD	PROTECTION	PROTEZIONE	SCHUTZ	PROTECCION	110
3	900.212.086	1	GUARD	PROTECTION	PROTEZIONE	SCHUTZ	PROTECCION	130
3	900.212.087	1	GUARD	PROTECTION	PROTEZIONE	SCHUTZ	PROTECCION	150
3	900.212.088	1	GUARD	PROTECTION	PROTEZIONE	SCHUTZ	PROTECCION	170
3	900.212.089	1	GUARD	PROTECTION	PROTEZIONE	SCHUTZ	PROTECCION	190
3	900.212.090	1	GUARD	PROTECTION	PROTEZIONE	SCHUTZ	PROTECCION	210
3	900.212.091	1	GUARD	PROTECTION	PROTEZIONE	SCHUTZ	PROTECCION	230
3	900.212.092	1	GUARD	PROTECTION	PROTEZIONE	SCHUTZ	PROTECCION	250
4	900.212.083	2	SIDE	FLANC	FIANCO	SEITE	FLANCO	
5	900.210.022	1	PLUG	BOUCHON	TAPPO	DECKEL	TAPON	
6	900.102.207	8	SCREW	VIS	VITE	SCHRAUBE	TORNILLO	
7	900.104.046	16	WASHER	RONDELLE	RONDELLA	ZWISCHENSCHIEBE	ARANDELA	
8	900211017.0	8	SPRING	RESSORT	MOLLA	FEDER	MUELLE	
9	900.103.019	24	NUT	ECROU	DADO	MUTTER	TUERCA	
10	900.102.019	24	SCREW	VIS	VITE	SCHRAUBE	TORNILLO	
11	900.102.211	2	SCREW	VIS	VITE	SCHRAUBE	TORNILLO	
12	900.212.154	4	SPACER	ENTRETOISE	DISTANZIALE	ABSTANDSRING	DISTANCIADOR	
13	900.212.081	1	PLATE	PLAQUE	PIASTRA	PLATTE	PLACA	
14	900.212.082	1	PLATE	PLAQUE	PIASTRA	PLATTE	PLACA	
15	900.212.079	1	SIDE	FLANC	FIANCO	SEITE	FLANCO	
16	900.212.080	1	SIDE	FLANC	FIANCO	SEITE	FLANCO	
17	900.102.233	4	SCREW	VIS	VITE	SCHRAUBE	TORNILLO	
18	900.103.071	4	NUT	ECROU	DADO	MUTTER	TUERCA	
19	900.212.020	2	ARM	BRAS	BRACCIO	ARM	BRAZO	
20	900.116.033	2	PIN	TOURILLON	PERNO	STIFT	PERNO	
21	900.108.006	2	SPLIT PIN	GOUPILLE	COPIGLIA	ARRETIERUNG	PASADOR	
22	900.102.011	-	SCREW	VIS	VITE	SCHRAUBE	TORNILLO	
23	900.102.012	2	SCREW	VIS	VITE	SCHRAUBE	TORNILLO	
24	900.103.018	-	NUT	ECROU	DADO	MUTTER	TUERCA	
25	900.104.022	2	WASHER	RONDELLE	RONDELLA	ZWISCHENSCHIEBE	ARANDELA	
26	900.102.294	-			INSERTO			
27	900.105.015	-	GREASE NIPPLE	GRAISSEUR	INGRASSATORE	SCHMIERNIPPEL	ENGRASADOR	
28	900.121.050	1	ADJUST SCREW		VITE REGISTRO			
29	900.212.126	1	EXSTENSION	PROLONGE	PROLUNGA	VERLAENGERUNG	PROLONGACION	
30	900.105.007	2	GREASE NIPPLE	GRAISSEUR	INGRASSATORE	SCHMIERNIPPEL	ENGRASADOR	
31	900.212.093	1	SIDE	FLANC	FIANCO	SEITE	FLANCO	
32	900.212.094	1	SIDE	FLANC	FIANCO	SEITE	FLANCO	
33	900.212.095	2	BUSH	COQUILLE	BOCCOLA	BUCHSE	CASQUILLO	
34	900.102.060	2	SCREW	VIS	VITE	SCHRAUBE	TORNILLO	
35	900.103.023	4	NUT	ECROU	DADO	MUTTER	TUERCA	
36	900.102.035	2	SCREW	VIS	VITE	SCHRAUBE	TORNILLO	
37	900.212.097	1	LEVELLING BAR	BARRE NIV.	BARRA LIV.	PLANIERSTANGE	BARRA NIVEL.	110
37	900.212.098	1	LEVELLING BAR	BARRE NIV.	BARRA LIV.	PLANIERSTANGE	BARRA NIVEL.	130
37	900.212.099	1	LEVELLING BAR	BARRE NIV.	BARRA LIV.	PLANIERSTANGE	BARRA NIVEL.	150
37	900.212.100	1	LEVELLING BAR	BARRE NIV.	BARRA LIV.	PLANIERSTANGE	BARRA NIVEL.	170
37	900.212.101	1	LEVELLING BAR	BARRE NIV.	BARRA LIV.	PLANIERSTANGE	BARRA NIVEL.	190
37	900.212.102	1	LEVELLING BAR	BARRE NIV.	BARRA LIV.	PLANIERSTANGE	BARRA NIVEL.	210
37	900.212.103	1	LEVELLING BAR	BARRE NIV.	BARRA LIV.	PLANIERSTANGE	BARRA NIVEL.	230
37	900.212.104	1	LEVELLING BAR	BARRE NIV.	BARRA LIV.	PLANIERSTANGE	BARRA NIVEL.	250
38	900.212.078	2	STAND	SUPPORT	SOSTEGNO	STUETZE	SOPORTE	

# ERL 3

## Frame

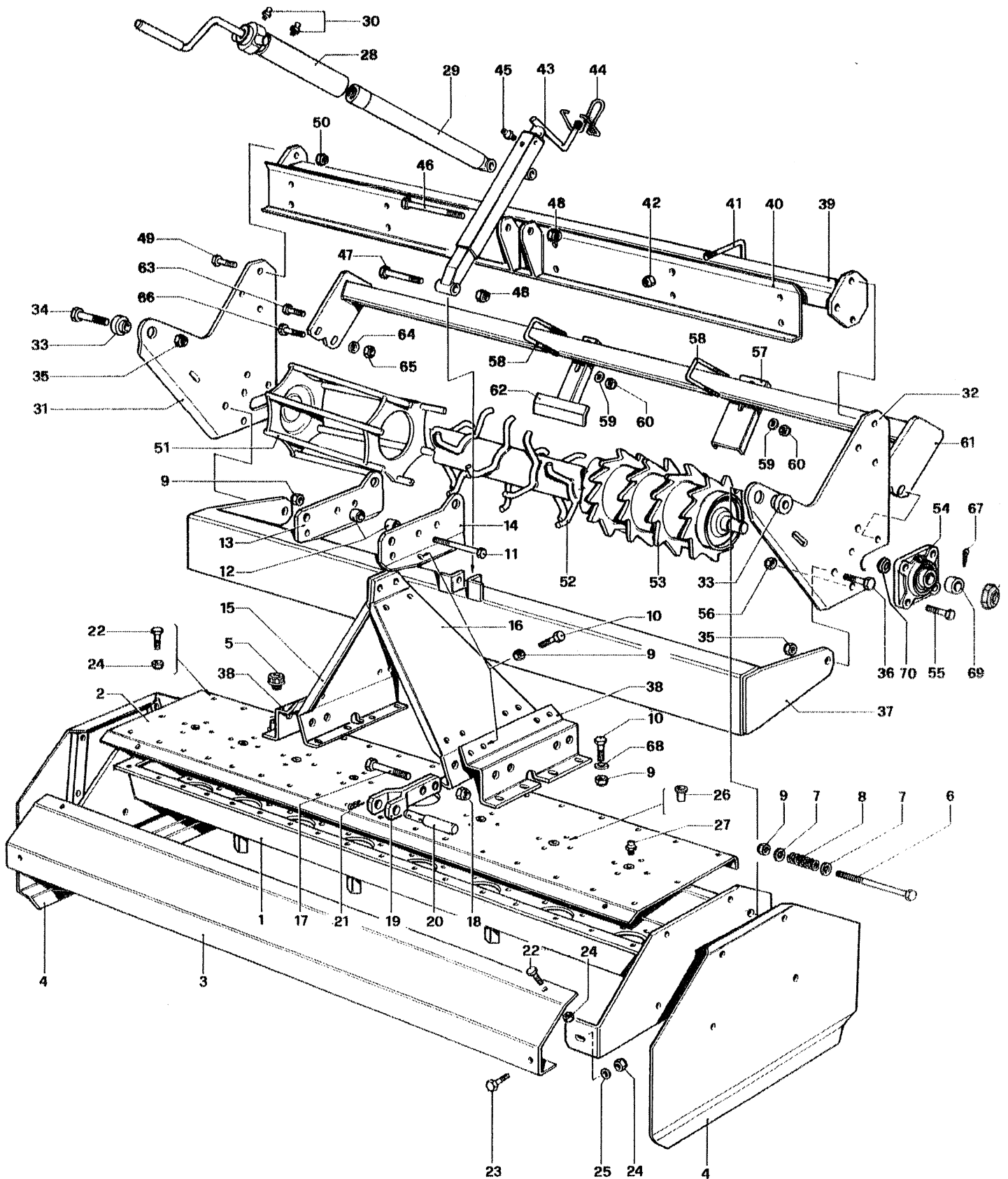



REF	CODE	QTY	ENGLISH	FRANÇAIS	ITALIANO	DEUTSCH	ESPAÑOL	NOTE
39	900.212.108	1	BAR	BARRE	BARRA	STANGE	BARRA	110
39	900.212.109	1	BAR	BARRE	BARRA	STANGE	BARRA	130
39	900.212.110	1	BAR	BARRE	BARRA	STANGE	BARRA	150
39	900.212.111	1	BAR	BARRE	BARRA	STANGE	BARRA	170
39	900.212.112	1	BAR	BARRE	BARRA	STANGE	BARRA	190
39	900.212.113	1	BAR	BARRE	BARRA	STANGE	BARRA	210
39	900.212.114	1	BAR	BARRE	BARRA	STANGE	BARRA	230
39	900.212.115	1	BAR	BARRE	BARRA	STANGE	BARRA	250
40	900.212.105	1	STAND	SUPPORT	SOSTEGNO	STUETZE	SOPORTE	110-130-150-170
40	900.212.106	1	STAND	SUPPORT	SOSTEGNO	STUETZE	SOPORTE	190-210-230-250
41	900.116.035	4	U-BOLT	MANILLE	CAVALLOTTO	U-BOLZEN	SOPORTE	110-130-150-170
41	900.116.035	6	U-BOLT	MANILLE	CAVALLOTTO	U-BOLZEN	SOPORTE	190-210-230-250
42	900.103.019	-	NUT	ECROU	DADO	MUTTER	TUERCA	
43	900.212.127	1	ADJUST SCREW		VITE REGISTRO			
44	900.212.128	1	STOP SCREW		ARRESTO VITE			
45	900.105.017	1	GREASE NIPPLE	GRAISSEUR	INGRASSATORE	SCHMIERNIPPEL	ENGRASADOR	
46	900.102.293	1	SCREW	VIS	VITE	SCHRAUBE	TORNILLO	
47	900.102.225	1	SCREW	VIS	VITE	SCHRAUBE	TORNILLO	
48	900.103.108	2	NUT	ECROU	DADO	MUTTER	TUERCA	
49	900.102.026	6	SCREW	VIS	VITE	SCHRAUBE	TORNILLO	
50	900.103.021	6	NUT	ECROU	DADO	MUTTER	TUERCA	
51	900.212.130	1	ROLLER	ROULEAU	RULLO	WALZE	RODILLO	110
51	900.212.131	1	ROLLER	ROULEAU	RULLO	WALZE	RODILLO	130
51	900.212.132	1	ROLLER	ROULEAU	RULLO	WALZE	RODILLO	150
51	900.212.133	1	ROLLER	ROULEAU	RULLO	WALZE	RODILLO	170
51	900.212.134	1	ROLLER	ROULEAU	RULLO	WALZE	RODILLO	190
51	900.212.135	1	ROLLER	ROULEAU	RULLO	WALZE	RODILLO	210
51	900.140.043	1	ROLLER	ROULEAU	RULLO	WALZE	RODILLO	230
51	900.211.043	1	ROLLER	ROULEAU	RULLO	WALZE	RODILLO	250
52	900.212.138	1	ROLLER	ROULEAU	RULLO	WALZE	RODILLO	110
52	900.212.139	1	ROLLER	ROULEAU	RULLO	WALZE	RODILLO	130
52	900.212.140	1	ROLLER	ROULEAU	RULLO	WALZE	RODILLO	150
52	900.212.141	1	ROLLER	ROULEAU	RULLO	WALZE	RODILLO	170
52	900.212.142	1	ROLLER	ROULEAU	RULLO	WALZE	RODILLO	190
52	900.212.143	1	ROLLER	ROULEAU	RULLO	WALZE	RODILLO	210
52	900.140.011	1	ROLLER	ROULEAU	RULLO	WALZE	RODILLO	230
52	900.211.046	1	ROLLER	ROULEAU	RULLO	WALZE	RODILLO	250
53	900.212.146	1	ROLLER	ROULEAU	RULLO	WALZE	RODILLO	110
53	900.212.147	1	ROLLER	ROULEAU	RULLO	WALZE	RODILLO	130
53	900.212.148	1	ROLLER	ROULEAU	RULLO	WALZE	RODILLO	150
53	900.212.149	1	ROLLER	ROULEAU	RULLO	WALZE	RODILLO	170
53	900.212.150	1	ROLLER	ROULEAU	RULLO	WALZE	RODILLO	190
53	900.212.151	1	ROLLER	ROULEAU	RULLO	WALZE	RODILLO	210
53	900.212.152	1	ROLLER	ROULEAU	RULLO	WALZE	RODILLO	230
53	900.212.153	1	ROLLER	ROULEAU	RULLO	WALZE	RODILLO	250
54	900.100.051	2	SUPPORT	SUPPORT	SUPPORTO	STUETZE	SOPORTE	
55	900.102.115	8	SCREW	VIS	VITE	SCHRAUBE	TORNILLO	
56	900.103.019	8	NUT	ECROU	DADO	MUTTER	TUERCA	
57	900.212.125	-	SCRAPER	RACLEUR	RASCHIARULLO	WALZENSCHABER	RASCARODILLO	
58	900.116.035	-	U-BOLT	MANILLE	CAVALLOTTO	U-BOLZEN	SOPORTE	
59	900.104.046	-	WASHER	RONDELLE	RONDELLA	ZWISCHENSCHLEIBE	ARANDELA	
60	900.103.019	-	NUT	ECROU	DADO	MUTTER	TUERCA	
61	900.212.117	1	BAR	BARRE	BARRA	STANGE	BARRA	110
61	900.212.118	1	BAR	BARRE	BARRA	STANGE	BARRA	130
61	900.212.119	1	BAR	BARRE	BARRA	STANGE	BARRA	150
61	900.212.120	1	BAR	BARRE	BARRA	STANGE	BARRA	170
61	900.212.121	1	BAR	BARRE	BARRA	STANGE	BARRA	190
61	900.212.122	1	BAR	BARRE	BARRA	STANGE	BARRA	210
61	900.212.123	1	BAR	BARRE	BARRA	STANGE	BARRA	230
61	900.212.124	1	BAR	BARRE	BARRA	STANGE	BARRA	250
62	900211057.0	-	SCRAPER	RACLEUR	RASCHIARULLO	WALZENSCHABER	RASCARODILLO	
63	900.102.115	2	SCREW	VIS	VITE	SCHRAUBE	TORNILLO	
64	900.104.046	4	WASHER	RONDELLE	RONDELLA	ZWISCHENSCHLEIBE	ARANDELA	
65	900.103.019	4	NUT	ECROU	DADO	MUTTER	TUERCA	
66	900.102.194	2	SCREW	VIS	VITE	SCHRAUBE	TORNILLO	
67	900.108.013	2	PIN	CHEVILLE	SPINA	DORN	CLAVIJA	
68	900.104.010	12	WASHER	RONDELLE	RONDELLA	ZWISCHENSCHLEIBE	ARANDELA	
69	900.212.155	2	SPACER	ENTRETOISE	DISTANZIALE	ABSTANDSRING	DISTANCIADOR	230

# ERL 3

## Gearbox

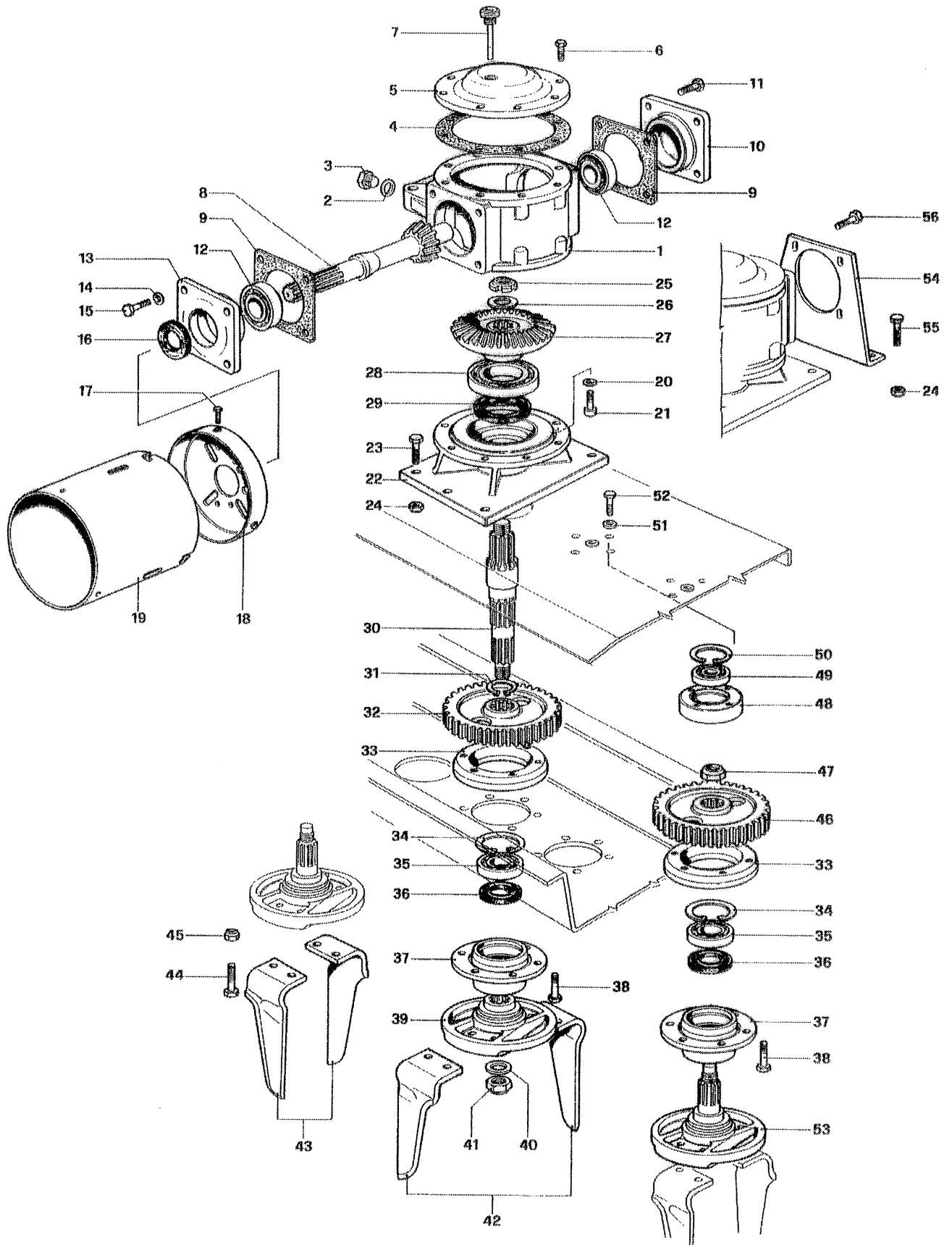

REF	CODE	QTY	ENGLISH	FRANÇAIS	ITALIANO	DEUTSCH	ESPAÑOL	NOTE
1	900.129.001	1	CASE	BOITE	SCATOLA	KISTE	CAJA	
2	900.104.032	1	WASHER	RONDELLE	RONDELLA	ZWISCHENSCHLEIBE	ARANDELA	
3	900.102.292	1	PLUG	BOUCHON	TAPPO	DECKEL	TAPON	
4	900.139.007	1	GASKET	JOINT	GUARNIZIONE	DICHTUNG	JUNTA	
5	900.212.068	1	LID	COUVERCLE	COPERCHIO	DECKEL	TAPA	
6	900.102.011	8	SCREW	VIS	VITE	SCHRAUBE	TORNILLO	
7	900.102.050	1	PLUG	BOUCHON	TAPPO	DECKEL	TAPON	
8	900.129.007	1	PINION	PIGNON	PIGNONE	RITZEL	PINON	
9	900.139.006	2	GASKET	JOINT	GUARNIZIONE	DICHTUNG	JUNTA	
10	900.129.003	1	CLAMPING	CHAPEAU	CAPPELOTTO	KAPPE	CAPUCHON	
11	900.102.019	4	SCREW	VIS	VITE	SCHRAUBE	TORNILLO	
12	900.100.023	2	BEARING	ROULEMENT	CUSCINETTO	KUGELLAGER	COJINETE	
13	900.129.002	1	CLAMPING	CHAPEAU	CAPPELOTTO	KAPPE	CAPUCHON	
14	900.104.010	4	WASHER	RONDELLE	RONDELLA	ZWISCHENSCHLEIBE	ARANDELA	
15	900.102.020	4	SCREW	VIS	VITE	SCHRAUBE	TORNILLO	
16	900.101.008	1	OIL SEAL	PARE-HUILE	PARAOLIO	SIMMERRING	PARA-ACEITE	
17	900.102.256	3	SCREW	VIS	VITE	SCHRAUBE	TORNILLO	
18	900.117.070	1	PROT. HOLDER	DISQUE	FONDELLO	ZWSCHUTZHALTER	DISCO	
19	900.117.072	1	GUARD	PROTECTION	PROTEZIONE	SCHUTZ	PROTECCION	
20	900.102.005	8	SCREW	VIS	VITE	SCHRAUBE	TORNILLO	
21	900.104.022	8	WASHER	RONDELLE	RONDELLA	ZWISCHENSCHLEIBE	ARANDELA	
22	900.212.070	1	BASE	BASE	BASE	BASIS	BASE	
23	900.102.052	6	SCREW	VIS	VITE	SCHRAUBE	TORNILLO	
24	900.103.019	6	NUT	ECROU	DADO	MUTTER	TUERCA	
25	900.103.069	1	RING NUT	EMBOUT	GHIERA	NUTMUTTER	CASQUILLO	
26	900.104.029	1	WASHER	RONDELLE	RONDELLA	ZWISCHENSCHLEIBE	ARANDELA	
27	900.129.008	1	CROWN	COURONNE	CORONA	TELLERRAD	CORONA	
28	900.100.012	1	BEARING	ROULEMENT	CUSCINETTO	KUGELLAGER	COJINETE	
29	900101007.0	1	OIL SEAL	PARE-HUILE	PARAOLIO	SIMMERRING	PARA-ACEITE	
30	900.212.069	1	SHAFT	ARBRE	ALBERO	WELLE	EJE	
31	900.106.015	1	CIRCLIP	SERFLEX	SEEGER	SEEGER	SEEGER	
32	900.212.071	1	GEAR	ENGRENAGE	INGRANAGGIO	ZAHNRAD	ENGRANAJE	
33	900.212.077	-	FLANGE	FLASQUE	FLANGIA	FLANSCH	BRIDA	
34	900.106.011	-	CIRCLIP	SERFLEX	SEEGER	SEEGER	SEEGER	
35	900.100.033	-	BEARING	ROULEMENT	CUSCINETTO	KUGELLAGER	COJINETE	
36	900.101.046	-	OIL SEAL	PARE-HUILE	PARAOLIO	SIMMERRING	PARA-ACEITE	
37	900.212.076	-	SUPPORT	SUPPORT	SUPPORTO	STUETZE	SOPORTE	
38	900.102.019	-	SCREW	VIS	VITE	SCHRAUBE	TORNILLO	
39	900.212.073	1	KNIFE-HOLDER	PORTE-COUTEAUX	PORTACOLTELLI	MESSERHALTER	PORTA-CUCHILLAS	
40	900.104.092	1	WASHER	RONDELLE	RONDELLA	ZWISCHENSCHLEIBE	ARANDELA	
41	900.103.072	1	NUT	ECROU	DADO	MUTTER	TUERCA	
42	900.111.056	-	KNIFE	COUTEAU	COLTELLO	MESSER	CUCHILLA	
43	900.111.057	-	KNIFE	COUTEAU	COLTELLO	MESSER	CUCHILLA	
44	900.102.218	-	SCREW	VIS	VITE	SCHRAUBE	TORNILLO	
45	900.103.063	-	NUT	ECROU	DADO	MUTTER	TUERCA	
46	900.212.072	-	GEAR	ENGRENAGE	INGRANAGGIO	ZAHNRAD	ENGRANAJE	
47	900.103.069	-	RING NUT	EMBOUT	GHIERA	NUTMUTTER	CASQUILLO	
48	900.212.075	-	SUPPORT	SUPPORT	SUPPORTO	STUETZE	SOPORTE	
49	900.100.047	-	BEARING	ROULEMENT	CUSCINETTO	KUGELLAGER	COJINETE	
50	900.106.028	-	CIRCLIP	SERFLEX	SEEGER	SEEGER	SEEGER	
51	900.104.010	-	WASHER	RONDELLE	RONDELLA	ZWISCHENSCHLEIBE	ARANDELA	
52	900.102.019	-	SCREW	VIS	VITE	SCHRAUBE	TORNILLO	
53	900.212.074	-	KNIFE-HOLDER	PORTE-COUTEAUX	PORTACOLTELLI	MESSERHALTER	PORTA-CUCHILLAS	
54	900.212.156	1	SUPPORT	SUPPORT	SUPPORTO	STUETZE	SOPORTE	190-210-230-250
55	900.102.021	3	SCREW	VIS	VITE	SCHRAUBE	TORNILLO	190-210-230-250
56	900.102.020	4	SCREW	VIS	VITE	SCHRAUBE	TORNILLO	190-210-230-250

# LIMITED WARRANTY POLICY



SOVEMA S.p.A., Manufacturer of quality machinery, guarantees new Sovema machinery from the time of delivery to the original purchaser to be free from defects in material and workmanship if properly set up and operated in accordance with recommendations set forth in SOVEMA's operator manual. SOVEMA's liability for any defect of accepted goods shall be limited to replacing them, or as SOVEMA shall elect.

The original purchaser will qualify for the SOVEMA warranty only after they have completed the warranty card in full and forwarded it to SOVEMA S.p.A. Italy or any SOVEMA branch.

SOVEMA's obligation shall terminate 12 (twelve) months after the date of purchase of the product by the original purchaser. This warranty cannot be assigned or transferred to anyone unless SOVEMA's consent in writing has first been obtained. All warranty claims must be forwarded to SOVEMA S.p.A. Italy or a SOVEMA branch within 8 (eight) days after occurrence.

The original purchaser will be responsible for and bear costs of:

- A) Normal maintenance such as greasing, maintenance of oil levels, minor adjustments, etc.
- B) Transportation of any kind of, any SOVEMA product to and from the place where warranty work is performed.

This warranty shall not apply to any machine which has been repaired or altered in any way outside the SOVEMA factory which affects its stability or reliability, nor which has been subject to misuse, negligence or accident, nor to any machine that has not been operated in accordance with SOVEMA's printed instructions, or operated beyond the company recommended capacity as per machine.

This warranty shall not be applicable to items which are subject to the warranties of their respective manufacturers. Such items would include but would not be limited to clutches, universal joints, knives, hydraulic components, bearings, tires, belts and other trade accessories.

This warranty shall not be applicable to items defined as normal wearing items. Such items would include but would not be limited to belts, discs, knives, tines stone guards, tires, slip clutches, pitman shaft, swath sticks, blades or tine holders.

The judgement of SOVEMA S.p.A. in all cases of claims under this warranty shall be final and conclusive and the original purchaser agrees to accept its decisions about all questions as to defects and/or to the exchange of any part or parts.

No Agent, Employee or Representative of SOVEMA has any authority to bind SOVEMA to any affirmation, representation or warranty, concerning its machinery excepts as specifically set forth.

SOVEMA shall not be liable for special or consequential damages of any kind caused by any

SOVEMA S.p.A.  
 Via Olmo, 6-8-10  
 41010 Gaggio di Piano (MO)  
 Italy

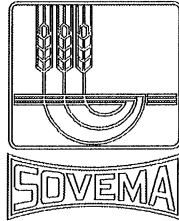

Telephone: 059 93 85 85  
 Fax : 059 93 85 12  
 E-mail : sovema@sovema.com  
 Web site: www.sovema.com

## WARRANTY REGISTRATION

This warranty will become valid only if this form is completed and signed by both the Purchaser and the Dealer and is returned within 8 days of purchase date! **IF NOT WARRANTY IS INVALID.**

### TO FILL OUT

- ❖ *TYPE OF IMPLEMENT* : \_\_\_\_\_
- ❖ *IMPLEMENT SERIAL NUMBER* : \_\_\_\_\_
- ❖ *DATE OF PURCHASE* : \_\_\_\_\_

<p><b>DEALER: I HEREBY CERTIFY THAT</b></p> <ul style="list-style-type: none"> <li>The machine has been correctly assembled in accordance with the manufacturers instructions.</li> <li>All nuts and bolts, oil level and grease have been checked.</li> <li>All safety guards and warning stickers have been placed on machine.</li> <li>PTO has been matched to tractor and greased.</li> <li>All other pre-delivery checks have been completed as per operators manual.</li> <li>Purchaser was given operators manual and instructed in safe and correct usage of machine and on limitation of warranty.</li> <li>Machine was tested and operates correctly.</li> </ul>	<p><b>PURCHASER: I HEREBY ACCEPT</b></p> <ul style="list-style-type: none"> <li>That the machine is correctly assembled.</li> <li>Receipt of the operators manual which I have read and have clearly understood..</li> <li>To have a clear understanding of the warranty limitations.</li> <li>To have a clear understanding of the correct and safe operation of the machine.</li> <li>That the machine need regular maintenance as instructions in operators manual.</li> <li>To have clear understanding on the capacity of this machine and made aware of its limitations.</li> </ul>
--	---

<p style="text-align: center;">(address)</p> <p>_____</p> <p>_____</p> <p>_____</p> <p>Date: _____ Signature: _____</p> <p style="writing-mode: vertical-rl; transform: rotate(180deg);"><b>DEALER</b></p>	<p style="text-align: center;">(address)</p> <p>_____</p> <p>_____</p> <p>_____</p> <p>Date: _____ Signature: _____</p> <p style="writing-mode: vertical-rl; transform: rotate(180deg);"><b>PURCHASER</b></p>
--	---

**COPY TO DELIVER TO: SOVEMA**



SOVEMA S.p.A.  
 Via Olmo, 6-8-10  
 41010 Gaggio di Piano (MO)  
 Italy

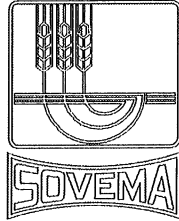

Telephone: 059 93 85 85  
 Fax : 059 93 85 12  
 E-mail : sovema@sovema.com  
 Web site: www.sovema.com

## WARRANTY REGISTRATION

This warranty will become valid only if this form is completed and signed by both the Purchaser and the Dealer and is returned within 8 days of purchase date! **IF NOT WARRANTY IS INVALID.**

### TO FILL OUT

- ❖ *TYPE OF IMPLEMENT* : \_\_\_\_\_
- ❖ *IMPLEMENT SERIAL NUMBER* : \_\_\_\_\_
- ❖ *DATE OF PURCHASE* : \_\_\_\_\_

<p><b>DEALER: I HEREBY CERTIFY THAT</b></p> <ul style="list-style-type: none"> <li>The machine has been correctly assembled in accordance with the manufacturers instructions.</li> <li>All nuts and bolts, oil level and grease have been checked.</li> <li>All safety guards and warning stickers have been placed on machine.</li> <li>PTO has been matched to tractor and greased.</li> <li>All other pre-delivery checks have been completed as per operators manual.</li> <li>Purchaser was given operators manual and instructed in safe and correct usage of machine and on limitation of warranty.</li> <li>Machine was tested and operates correctly.</li> </ul>	<p><b>PURCHASER: I HEREBY ACCEPT</b></p> <ul style="list-style-type: none"> <li>That the machine is correctly assembled.</li> <li>Receipt of the operators manual which I have read and have clearly understood..</li> <li>To have a clear understanding of the warranty limitations.</li> <li>To have a clear understanding of the correct and safe operation of the machine.</li> <li>That the machine need regular maintenance as instructions in operators manual.</li> <li>To have clear understanding on the capacity of this machine and made aware of its limitations.</li> </ul>
--	---

<p style="text-align: center;">(address)</p> <p>_____</p> <p>_____</p> <p>_____</p> <p>Date: _____ Signature: _____</p> <p style="writing-mode: vertical-rl; transform: rotate(180deg);"><b>DEALER</b></p>	<p style="text-align: center;">(address)</p> <p>_____</p> <p>_____</p> <p>_____</p> <p>Date: _____ Signature: _____</p> <p style="writing-mode: vertical-rl; transform: rotate(180deg);"><b>PURCHASER</b></p>
--	---

**PURCHASER COPY**

# SOVEMA Product Line

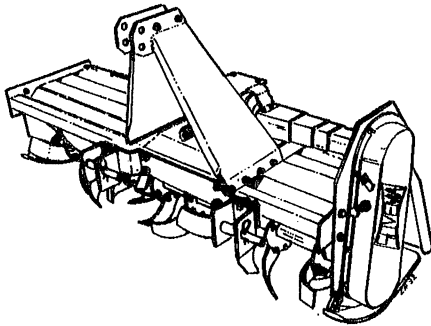

## SIDE SHIFT ROTARY TILLERS

- 15 different models;
- For tractors from 12 to 70 HP
- Working width from 80 to 200 cm.

## FIXED ROTARY TILLERS

- Over 45 different models;
- For tractors from 15 to 130 HP
- Working width from 80 to 300 cm.

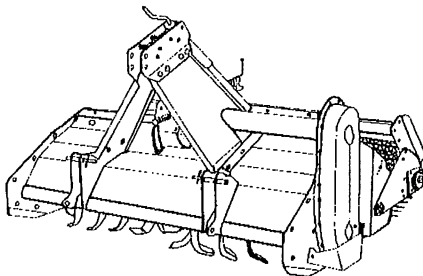
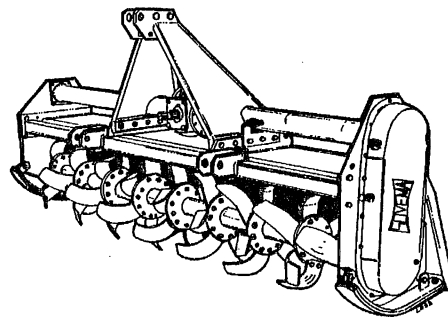

## STONE BURRIERS

- 6 different models;
- For tractors from 35 to 90 HP
- Working width from 100 to 200 cm.

## ROTARY HARROWS

- 13 different models;
- For tractors from 25 to 150 HP
- Working width from 110 to 500 cm.

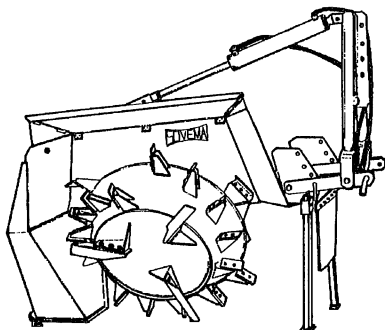
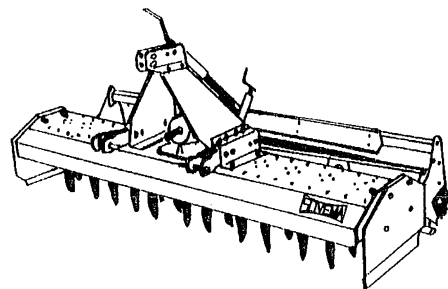

## ROTARY DITCHERS

- 10 different models;
- For tractors from 40 to 130 HP
- Working depth from 45 to 110 cm.



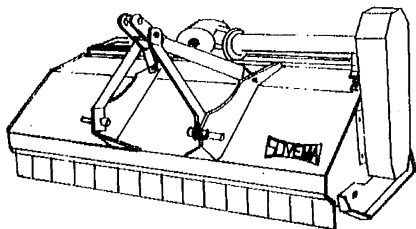

### FLAIL MOWERS - SHREDDERS

- 35 different models;
- For tractors from 15 to 120 HP
- Working width from 100 to 470 cm.

### MOWERS COLLECTOR

- 6 different models;
- For tractors from 30 to 60 HP
- Working width from 120 to 180 cm.
- Available with high discharge and low discharge

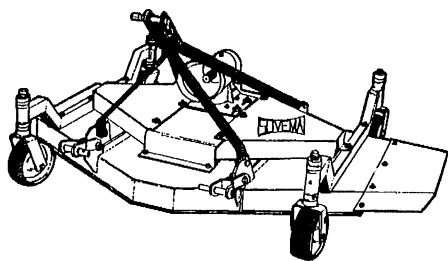
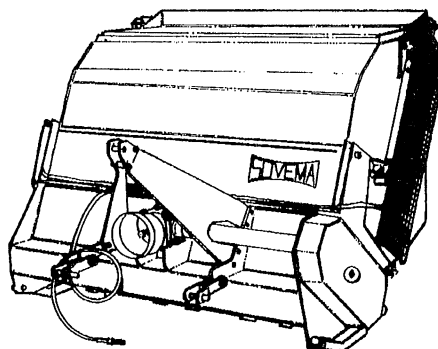

### FINISHING MOWERS

- 14 different models;
- For tractors from 15 to 70 HP
- Working width from 100 to 300 cm.

### HYDRAULIC FORK-LIFTS

- 11 different models;
- For tractors up to 60 HP
- Lifting capacity from 1.300 Kg to 2.000 Kg.

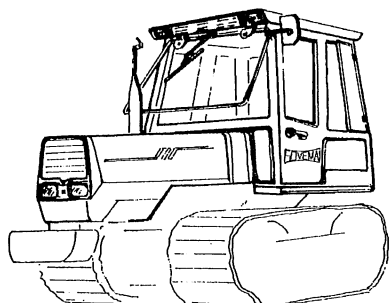
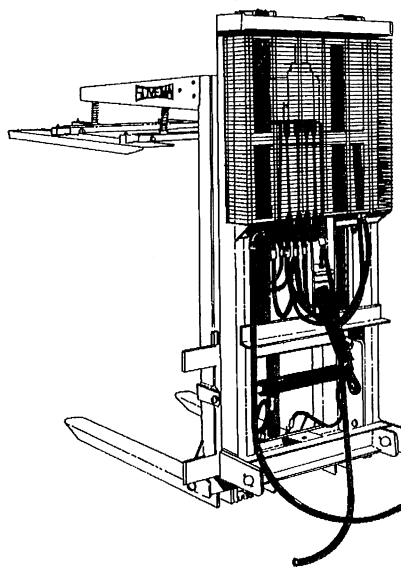

### TRACTOR CABS

- Over twenty models of cabs for eleven manufacturers of tractors;
- For tractors with wheels or crawlers;
- All models available with heating and/or air conditioned.

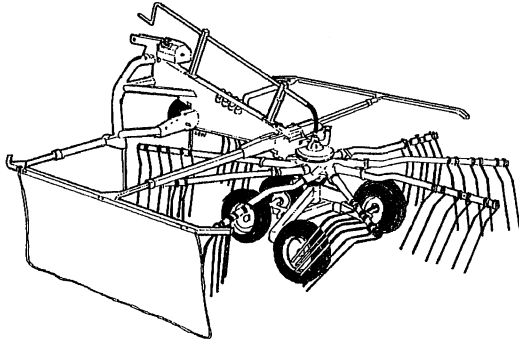

### **ROTARY RAKE**

- 4 different models
- For tractors from 30 to 70 HP
- Working width from 340 to 695 cm.

### **HAY TEDDERS**

- 6 different models (2, 4, 6 rotors)
- For tractors from 10 to 40 HP
- Working width from 310 to 730 cm.

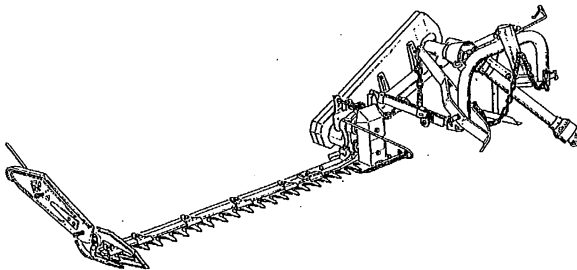
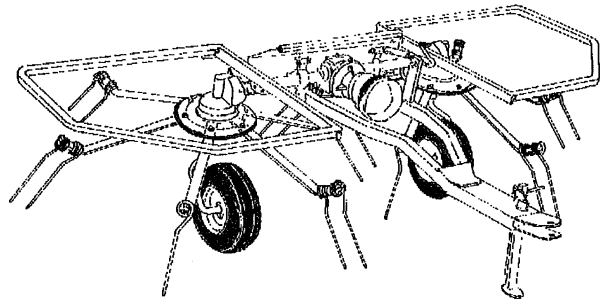

### **SICKLE BAR MOWER**

- 3 different models.
- For tractors from 10 to 15 HP.

### **FINGER WHEELS**

- 8 different models (8-20 stars)
- For tractors from 30 to 80 HP
- Working width from 7.35 to 12.50 m.

