



Del Morino

GENERAL CATALOGUE  
CATALOGUE GÉNÉRAL  
GESAMTKATALOG  
CATALOGO GENERALE

20  
25



Del Morino®

FARM & GARDEN EQUIPMENT











# INDEX/ INDICE



## Fixed rotary tillers Fraises fixes Feste Bodenfräsen Zappatrici fisse

<b>Tango</b> / 12 - 30 HP	<b>p. 24</b>
<b>Flash</b> / 12 - 25 HP	<b>p. 26</b>
<b>Thunder</b> / 12 - 40 HP	<b>p. 28</b>
<b>Eagle</b> / 12 - 50 HP	<b>p. 30</b>
<b>URT HF</b> / 30 - 70 HP	<b>p. 32</b>
<b>HRA</b> / 50 - 95 HP	<b>p. 34</b>



## Seeders Semoirs Sämaschinen Seminatrici

<b>Grass</b>	<b>p. 50</b>
<b>Professional</b>	<b>p. 52</b>



## Side shift rotary tillers Fraises déportables Seitenverschiebbare Bodenfräsen Zappatrici spostabili

<b>Holiday R</b> / 15 - 40 HP	<b>p. 36</b>
<b>Holiday RS</b> / 15 - 50 HP	<b>p. 38</b>
<b>URT ED</b> / 20 - 50 HP	<b>p. 40</b>



## Brush mowers Broyeurs Mulchgeräte Trinciatrici

<b>Ginger</b> / 12 - 30 HP	<b>p. 58</b>
<b>Funny</b> / 12 - 30 HP	<b>p. 60</b>
<b>Funny Top</b> / 12 - 30 HP	<b>p. 62</b>
<b>Disco</b> / 12 - 40 HP	<b>p. 64</b>
<b>Disco Top</b> / 12 - 40 HP	<b>p. 66</b>
<b>Centurion</b> / 15 - 50 HP	<b>p. 68</b>
<b>Flipper</b> / 15 - 70 HP	<b>p. 70</b>
<b>Farm</b> / 50 - 80 HP	<b>p. 72</b>
<b>Levante</b> / 50 - 120 HP	<b>p. 74</b>
<b>Levante Plus</b> / 80 - 120 HP	<b>p. 76</b>
<b>Victor</b> / 50 - 120 HP	<b>p. 78</b>
<b>DMK</b> / 15 - 80 HP	<b>p. 80</b>



## Rotary harrows Herses rotatives Kreiseleggen Erpici rotanti

<b>Yellowstone</b> / 20 - 50 HP	<b>p. 42</b>
<b>Rotex L</b> / 12 - 25 HP	<b>p. 44</b>
<b>Rotex M</b> / 15 - 45 HP	<b>p. 46</b>
<b>Rotex H</b> / 40 - 100 HP	<b>p. 48</b>



## Offset flail mowers Broyeurs d'accotement Auslegemulcher Trinciatrici laterali

<b>Funny Super</b> / 15 - 35 HP	<b>p. 84</b>
<b>Centurion Super</b> / 15 - 60 HP	<b>p. 86</b>
<b>Flipper Super</b> / 50 - 80 HP	<b>p. 88</b>
<b>Levante Super</b> / 80 - 120 HP	<b>p. 90</b>

## Engine driven flail mowers Broyeurs à moteur Schlegelmulcher mit Motor Trinciatrici a motore trainate

<b>Centurion ATV</b> / 13 HP	<b>p. 94</b>
<b>Centurion ATV PRO</b> / 25 HP	<b>p. 96</b>





**Finishing mowers**  
**Tondeuses de finition**  
**Feinarbeit Sichelmäherwerke**  
**Tagliaerba di finitura**

<b>ET / 12 - 25 HP</b>	<b>p. 102</b>
<b>SRM / 12 - 70 HP</b>	<b>p. 104</b>
<b>PRM / 12 - 70 HP</b>	<b>p. 106</b>
<b>Omega / 40 - 90 HP</b>	<b>p. 108</b>



**Shredders**  
**Broyeurs à végétaux**  
**Holzhäcksler**  
**Biotrituratori**

<b>BiOnda / 5 - 6 Ø</b>	<b>p. 112</b>
<b>Pugio / 5 - 6 Ø</b>	<b>p. 114</b>
<b>Vulcan / 5 - 6 Ø</b>	<b>p. 116</b>
<b>Scutum / 7 - 9 Ø</b>	<b>p. 118</b>
<b>Argo / 10 Ø</b>	<b>p. 120</b>
<b>Scorpion / 12 - 14 Ø</b>	<b>p. 122</b>



**Back hoes**  
**Retropelles**  
**Dreipunkthydraulikbagger**  
**Retroescavatori**

<b>RES 10 / 10 - 35 HP</b>	<b>p. 124</b>
<b>RES 15 - 20 - 30 / 15 - 60 HP</b>	<b>p. 126</b>



**Potato diggers**  
**Arracheuses de pommes de terre**  
**Kartoffelroder**  
**Cavapatate**

<b>DM 50 / 12 - 30 HP</b>	<b>p. 128</b>
<b>DM 100 / 30 - 50 HP</b>	<b>p. 129</b>



**Accessories 3 p**  
**Accessoires 3 p**  
**Dreipunkt-Anbaugeräte**  
**Accessori 3 p**

<b>RM / 12 - 30 HP</b>	<b>p. 132</b>
<b>RM-H / 12 - 30 HP</b>	<b>p. 133</b>
<b>CR7 / 12 - 30 HP</b>	<b>p. 134</b>
<b>CR / 30 - 40 HP</b>	<b>p. 135</b>
<b>CL / 12 - 30 HP</b>	<b>p. 136</b>
<b>CM / 30 - 40 HP</b>	<b>p. 137</b>
<b>BPO A / 12 - 30 HP</b>	<b>p. 138</b>
<b>BPO-AR / 12 - 30 HP</b>	<b>p. 139</b>



**Various**  
**Divers**  
**Verschiedenes**  
**Varie**

<b>BEN / 15 - 40 HP</b>	<b>p. 140</b>
<b>RUL / 20 - 50 HP</b>	<b>p. 141</b>











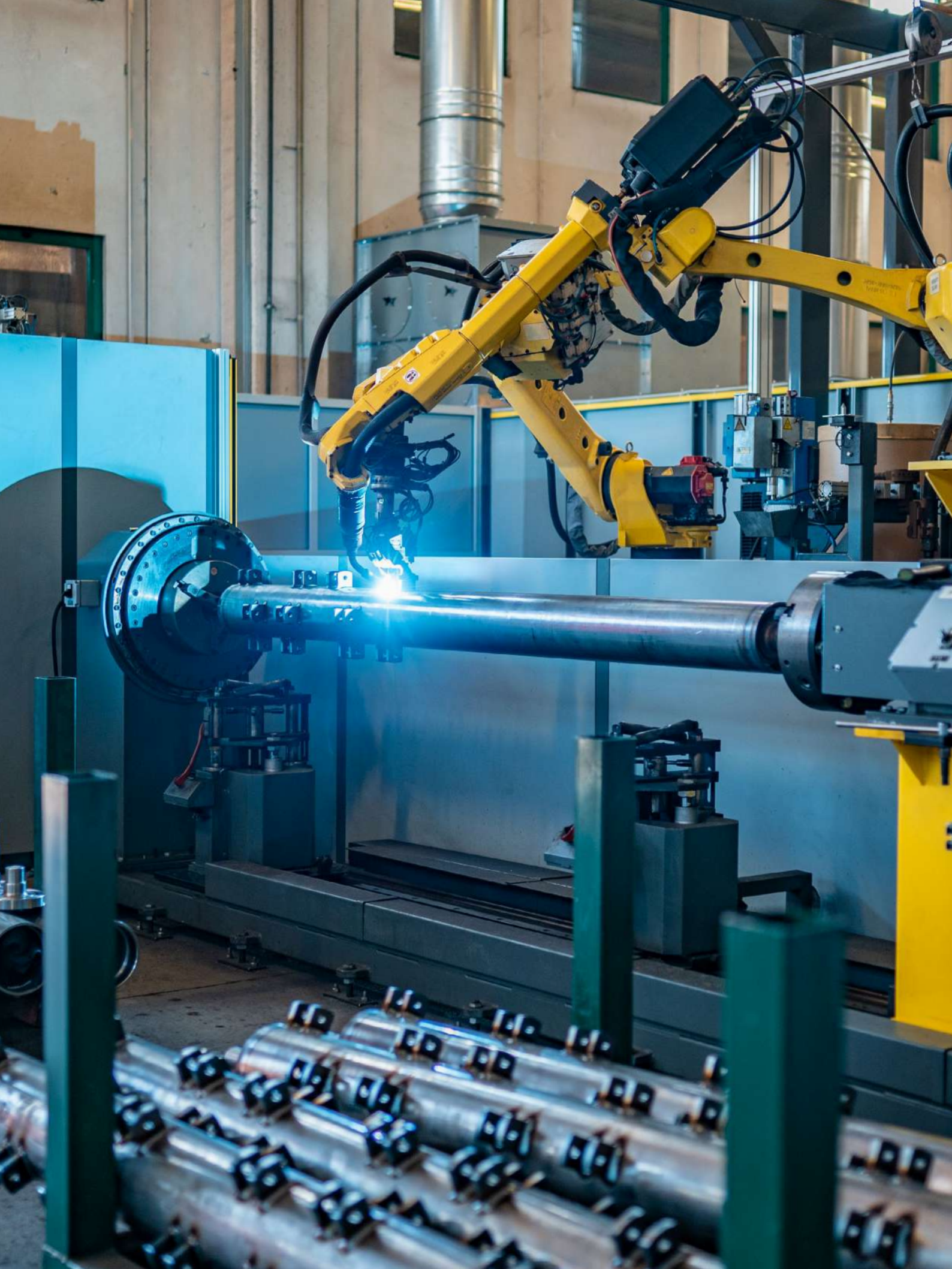



# Del Morino 1875

## – *Del Morino* – *Farm & garden equipment*

### Message from the President

Thank you for your interest in **Del Morino** products. I am sure that you will find our catalogues of a great value when looking for farm machinery (Rotary Tillers, Harrows, Ploughs, Tillers) for cultivation, gardening or landscaping (Rotary Slashers, Finishing mowers, Flail mowers, Chipper-Shredders), for dumping (dumper transport boxes) or for moving (Back hoes).

Del Morino S.r.l. was established in 1875 in Caprese Michelangelo, the birthplace of the famous artist and it is situated on the hills of beautiful Tuscany, destination for those who look for art, nature, tranquility and good food.

For more than 140 years, Del Morino's company has dedicated itself to supplying high quality products and supporting Italian and foreign companies which are leaders in farm and garden equipment.

In its constant research for quality, Del Morino announces that it has a new organizational structure in accordance with the guidelines of ISO 9001, that was originally designed to provide quick answers and great flexibility.

Quality through innovation is the principle of the Company: systematic evaluation of innovations and improvements that are always compatible with the environment, rewarding the company with sales that have tripled in two years, commercializing its products all around the world.

Considering these factors I confirm our desire to continue our progress with 4 fundamental points:

- To guarantee that all input from you will be considered with the utmost seriousness and commitment on our part.
- To supply products and services that meet our clients' needs, thus gaining their trust and support.
- To eliminate barriers to creativity, expressing our natural ability for quick solutions and association of ideas.
- To contribute in creating "Business Network" by developing and enlarging the vision of a total market with our collaborators who are inexhaustible source of new ideas, new solutions and new products.

Thank You for everything you will do to improve our reciprocal interest.

**Daniele Del Morino**  
*President*

### Message du Président

Merci de l'intérêt que vous portez à l'entreprise **Del Morino**. Je suis sûr que vous trouverez dans nos catalogues une précieuse référence quand vous chercherez les outils agricoles pour la culture (Fraises, Herses, Charrues) pour le Jardinage ou l'Entretien des tapis de gazon (Gyrobroyeurs, Tondeuses, Broyeurs), pour le « mouvement » (Bennes ou Retropelles) ou pour la récolte des pommes de terre.

La maison Del Morino fondée en 1875 à Caprese Michelangelo, village natal du célèbre artiste, se trouve parmi les collines de la belle Toscane, destination idéale pour ceux qui recherchent l'art, la nature, la tranquillité, le recueillement et la bonne cuisine.

Depuis plus de 140 ans la maison Del Morino consacre son activité à fournir des produits de haute qualité, et à soutenir, grâce à des projets de développement, plusieurs maisons italiennes et étrangères leaders dans la construction et la distribution de machines pour l'agriculture et le jardinage.

La maison Del Morino annonce d'avoir rendu effective une nouvelle structure organisatrice et compatible avec les règlements ISO 9001 originellement projetés à promptitude de réponse, grande flexibilité, constante recherche de la qualité.

La gestion de cette entreprise est fondée sur deux principes fondamentaux: la qualité et l'innovation. L'analyse systématique des innovations et des améliorations dans le respect de l'environnement, récompense l'entreprise qui pendant les cinq dernières années a multiplié ses ventes par trois, commercialisant ses produits dans le monde entier.

Tenu compte de ces résultats, je ne peux qu'affirmer notre volonté de continuer dans cette voie au moyen de quatre engagements majeurs:

- Fournir des produits et des services qui puissent satisfaire les exigences de nos clients et gagner leur confiance et leur appui avec enthousiasme.
- Eliminer les barrières qui font obstacle à la créativité, en exprimant notre naturelle disposition aux solutions rapides et aux associations d'idées.
- Contribuer à la création de "Business Network", source inépuisable de nouvelles idées, de nouvelles solutions et de nouveaux produits en développant et étendant une vision du marché avec nos collaborateurs et nos clients.
- Garantir que chacun de Vos input soit traité avec la plus grande attention.

Je Vous remercie pour tout ce que vous ferez pour améliorer nos intérêts réciproques.

**Daniele Del Morino**  
*Président*



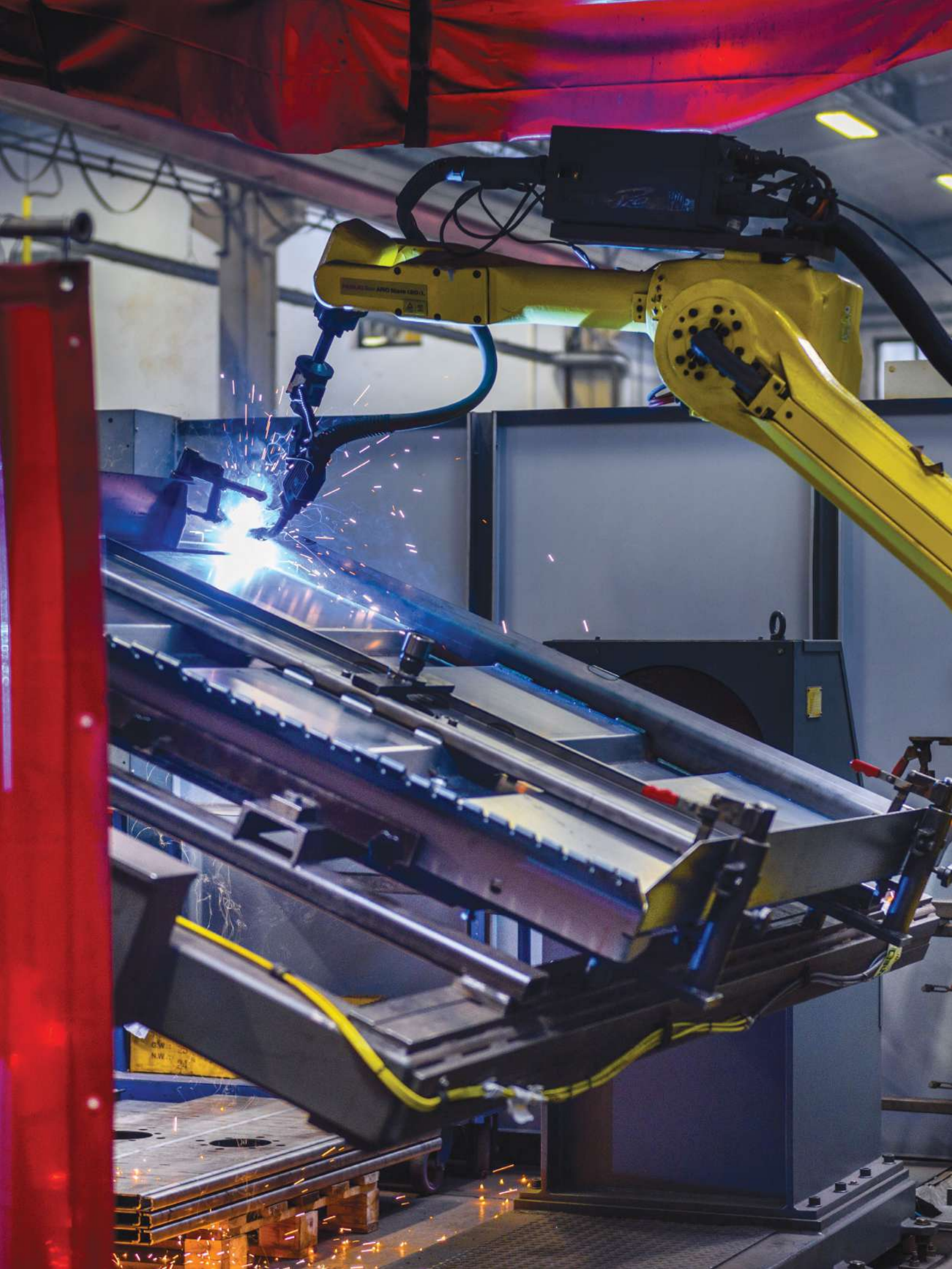

# Del Morino 1875

## – *Del Morino* – *Farm & garden equipment*

### Wort des Präsidenten

Vielen Dank für Ihr Interesse an den **Del Morino** Produkten. Ich bin sicher, dass Sie in unseren Katalogen eine wertvolle Referenz finden, wenn Sie nach Landmaschinen für den Anbau (Pflüge, Fräsen, Ackerfräsen), Gartenbau (Sichelmähwerke, Mulchgeräte, Häcksler) und Transport (Heckbagger, Transportboxen), wie auch für die Ernte (Kartoffelroder) suchen.

Del Morino S.r.l. wurde 1875 in Caprese Michelangelo gegründet, dem Geburtsort des berühmten Künstlers. Es liegt zwischen den malerischen Hügeln der schönen Toskana und ist Ziel derer, die noch auf der Suche nach großer Kunst, Natur, Ruhe und gutem Essen sind.

Seit über 140 Jahren richtet Del Morino seine Aktivitäten darauf aus, Produkte von höchster Qualität zu liefern und unterstützt durch Entwicklungsprojekte führende italienische und internationale Landwirtschafts- und Landschaftsbaumaschinen- Herstellern in der Recherche und der Realisierung von Prototypen.

Auf der ständigen Suche nach Qualität kann Del Morino heute mitteilen, eine neue Organisationsstruktur stabilisiert zu haben, die mit den Richtlinien von ISO 9001 kompatibel ist, welche entwickelt wurde um prompte Antworten und eine große Flexibilität zu bieten.

Qualität durch Innovation ist das Motto der Unternehmensführung; Systematische Untersuchungen der Innovationen und Verbesserungen – immer in Einklang mit der Umwelt – belohnen das Unternehmen mit einer Verdreifachung der Verkäufe innerhalb von zwei Jahren.

Unter Betrachtung dieser Faktoren kann ich bestätigen, dass unser Wille zum Fortschritt sich an diesen 4 Punkten festmacht:

- Produkte und Service anbieten, die den Bedürfnissen der Kunden entsprechen und dadurch das Vertrauen und die Unterstützung unserer Kunden gewinnen.
- Kreativitätsbarrieren aus dem Weg räumen und unserer natürlichen Veranlagung für schnelle Lösungen und gedankliche Assoziationen Ausdruck verleihen.
- Zu der Bildung eines "Business Network" beitragen, indem wir gemeinsam mit unseren Ingenieuren, welche eine unerschöpfliche Quelle neuer Ideen, neuer Lösungen und neuer Produkte sind, eine Vision und Übersicht des Gesamtmarktes entwickeln und erweitern.
- Garantieren dass jede Idee, die von Ihnen geliefert wird, von uns mit größter Sorgfalt und Engagement behandelt wird.

Ich danke Ihnen schon jetzt für all das, was Sie für die Verbesserung unserer gegenseitigen Interessen tun werden.

**Daniele Del Morino**  
*Präsident*

### Messaggio del Presidente

Grazie del Vostro interesse per i prodotti **Del Morino**. Sono certo che troverete nei nostri cataloghi un prezioso riferimento quando cercherete attrezzature agricole per la Coltivazione (Aratri, Frese, Tiller), per il giardinaggio e manutenzione del verde (Tagliaerba, Girotrincia, Trincia, Biotrituratori), per la Movimentazione (Retroescavatori e Cassoncini) e per la Raccolta (Scavapatate).

Del Morino S.r.l. è stata fondata nel 1875 in Caprese Michelangelo, paese natale del famoso artista, è situata tra le colline della bellissima Toscana, meta di chi ricerca ancora la grande arte, la natura, la tranquillità, il raccoglimento e la buona tavola.

Da oltre 140 anni, la Del Morino dedica la sua attività a fornire prodotti di alta qualità, a supportare nella ricerca e realizzazione di prototipi – attraverso progetti di sviluppo – aziende italiane ed estere leader nelle macchine per agricoltura e giardinaggio.

Alla costante ricerca della qualità, la Del Morino annuncia di aver reso effettiva una nuova struttura organizzativa compatibile con linee guida delle normative ISO 9001 - ISO 14000 - OSHAS 8000, originariamente progettate a prontezza di risposta, grande flessibilità, qualità dell'ambiente e sicurezza.

La qualità attraverso l'innovazione è il principio di gestione aziendale; l'esame sistematico delle innovazioni e dei miglioramenti conseguiti sempre in compatibilità con l'ambiente, premiano l'azienda che (in due anni ha triplicato le proprie vendite) commercializzando i suoi prodotti in quaranta paesi differenti.

In considerazione di questi fattori, posso confermare la nostra volontà nel continuare il cammino alla luce di 4 punti fondamentali:

- Fornire prodotti e servizi che incontrino i bisogni dei clienti acquistando la loro fiducia e il loro supporto in modo entusiasta.
- Eliminare barriere alla creatività, esprimendo la nostra naturale attitudine a rapide soluzioni e associazioni di idee.
- Contribuire a creare "Business Network" sviluppando e ampliando una visione del mercato globale insieme ai nostri collaboratori, fonte inesauribile di nuove idee, nuove soluzioni e nuovi prodotti.
- Garantire che ogni input da Voi fornito sarà da noi considerato con massima serietà ed impegno.

Vi ringrazio per tutto ciò che farete per migliorare i nostri reciproci interessi.

**Daniele Del Morino**  
*Presidente*





TruBend 5230



FANUC Robot R-2000iC 200C







Andrea and Daniele Del Morino



Quality – Qualité  
 Qualität – Qualità  
**UNI ISO 9001**

Safety – Sécurité  
 Sicherheit – Sicurezza  
**OHSAS 18001**

Environment – Milieu  
 Umwelt – Ambiente  
**UNI ISO 14000**

Social responsibility  
 Responsabilité sociale  
 Soziale verantwortung  
 Responsabilità sociale  
**UNI ISO 26000**

## Company – Entreprise Firma – Azienda



### Company

In its constant search for quality, Del Morino S.r.l. confirms that in 2004 it introduced a new organizational structure in accordance with the guidelines of UNI ISO 9001:2008 standard. Moreover Del Morino S.r.l. has always fostered the regulations related to the protection of the environment and the employees by controlling the working environment and the emissions related to the production process.

### Entreprise

Toujours à la recherche de l'excellence, la Del Morino S.r.l. déclare d'avoir rendu effective depuis 2004 une nouvelle structure compatible avec les réglementations UNI ISO 9001:2008. Depuis toujours, la maison Del Morino S.r.l. encourage la sauvegarde de l'environnement et des travailleurs, et s'engage au contrôle des lieux de travail, et des émissions résultant de la production.

### Firma

Auf der ständigen Suche nach Qualität kann Del Morino S.r.l. mitteilen, seit 2004 eine neue Organisationsstruktur stabilisiert zu haben, welche die Richtlinien von UNI ISO 9001:2008 erfüllt. Darüber hinaus treibt Del Morino S.r.l. schon seit jeher die Bestimmungen zum Schutze der Umwelt und der Arbeiter voran, und müht sich um die Kontrolle des Arbeitsumfeldes und der Emissionen, die aus der Produktion hervorgehen.

### Azienda

Alla costante ricerca della qualità, la Del Morino S.r.l. dichiara di aver reso effettiva dal 2004 una nuova struttura organizzativa osservando le linee guida della norma UNI ISO 9001:2008. Inoltre la Del Morino S.r.l. da sempre promuove le normative che disciplinano la tutela dell'ambiente e dei lavoratori, impegnandosi al controllo dell'ambiente di lavoro e delle emissioni derivate dalle produzioni.





# Eco-sustainability – Eco-friendly Eco-aufrechterhaltung – Ecosostenibilità

Since 2010, 8,000 square meters of photovoltaic panels have been installed, reducing CO2 emissions in the atmosphere by 2,000 tons per year. A production of approximately 1,800 kW/h makes our production activities 100% independent from external electricity needs.

La réalisation en 2010 de 8000 mètres carrés de panneaux photovoltaïques garantit une réduction des émissions jusqu'à 2000 tonnes de CO2 par an. Une production d'environ 1800 kW/h rend les activités de production 100 % indépendantes en termes de besoins d'énergie.

Die Anschaffung vom Jahr 2010 von 8.000 Quadratmetern Photovoltaikanlagen, garantieren eine CO2 Emissionen Reduzierung von 2.000 Tonnen pro Jahr. Die Produktion von 1.800 kW/h macht unsere Produktion 100% Unabhängig von externe Stromversorgung.

La realizzazione dal 2010 di 8.000 metri quadrati di pannelli fotovoltaici, garantiscono una riduzione delle emissioni in atmosfera equivalenti a 2.000 tonnellate di CO2 all'anno. Una produzione di circa 1.800 kW/h rende le attività di produzione indipendenti per il 100% da fabbisogni di energia elettrica esterna.

## ISO 5001 Oriented

Energy management system aimed at using energy more efficiently and preserving resources.

## ISO 5001 Orientè

Système de certification de la gestion des ressources énergétiques orientée aux économies d'énergie.

## ISO 5001 Orientert

Systematischer Energiemanagement um Energie effizienter zu nutzen was auch zum Umweltschutz

## ISO 5001 Orientata

Sistema di certificazione della gestione delle risorse energetiche orientata al risparmio.

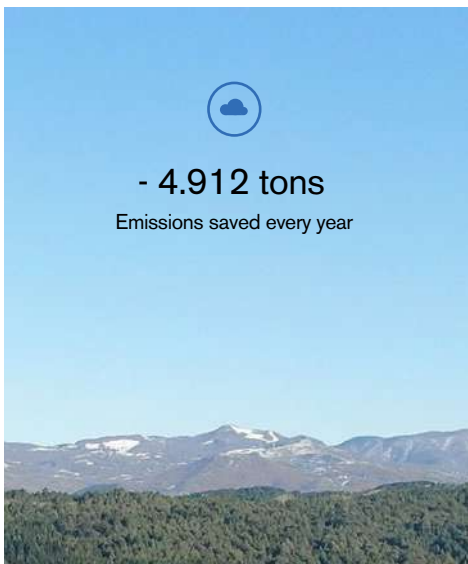
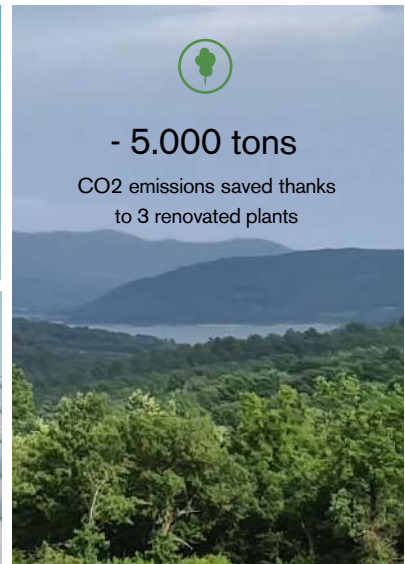
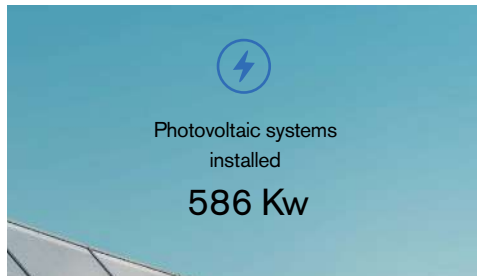



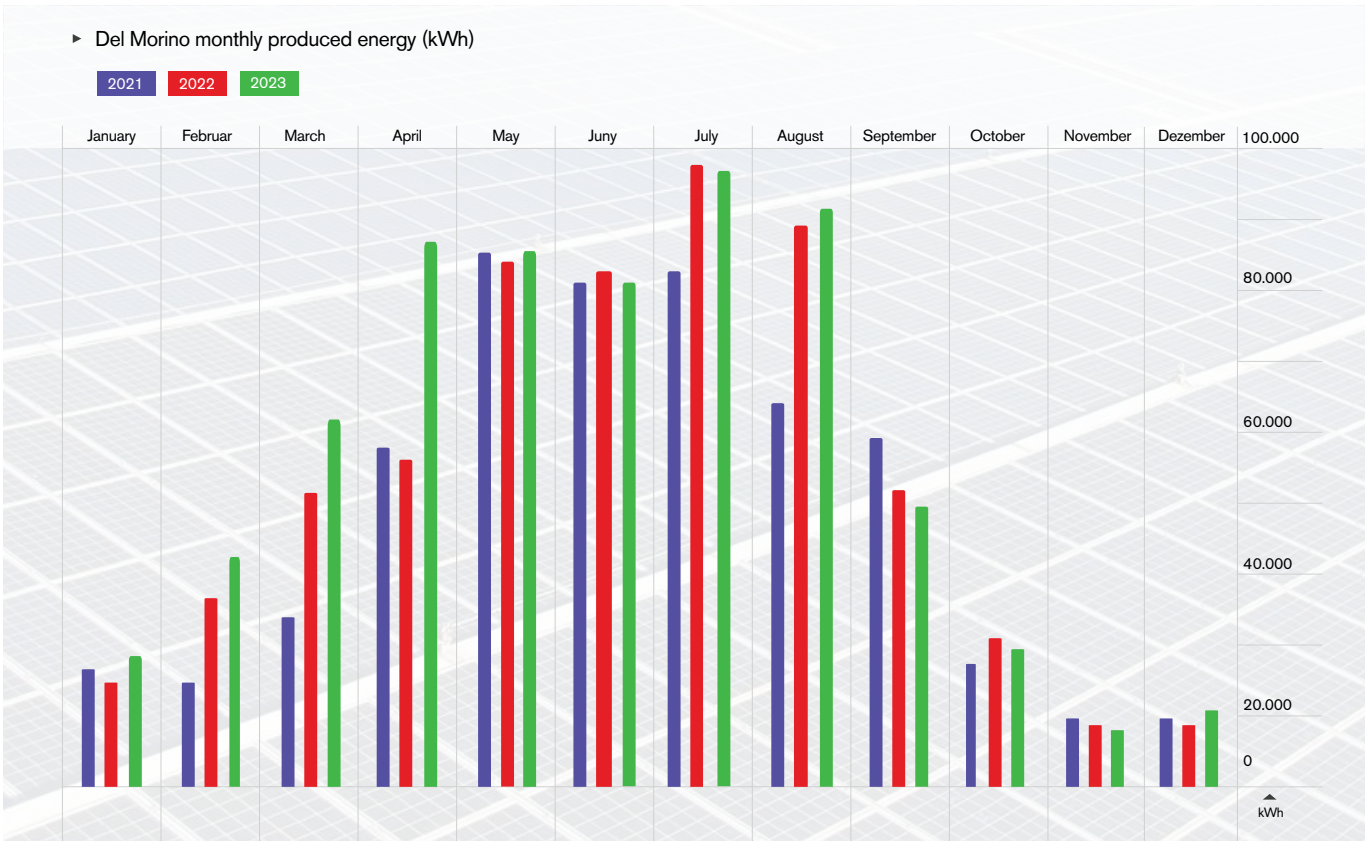
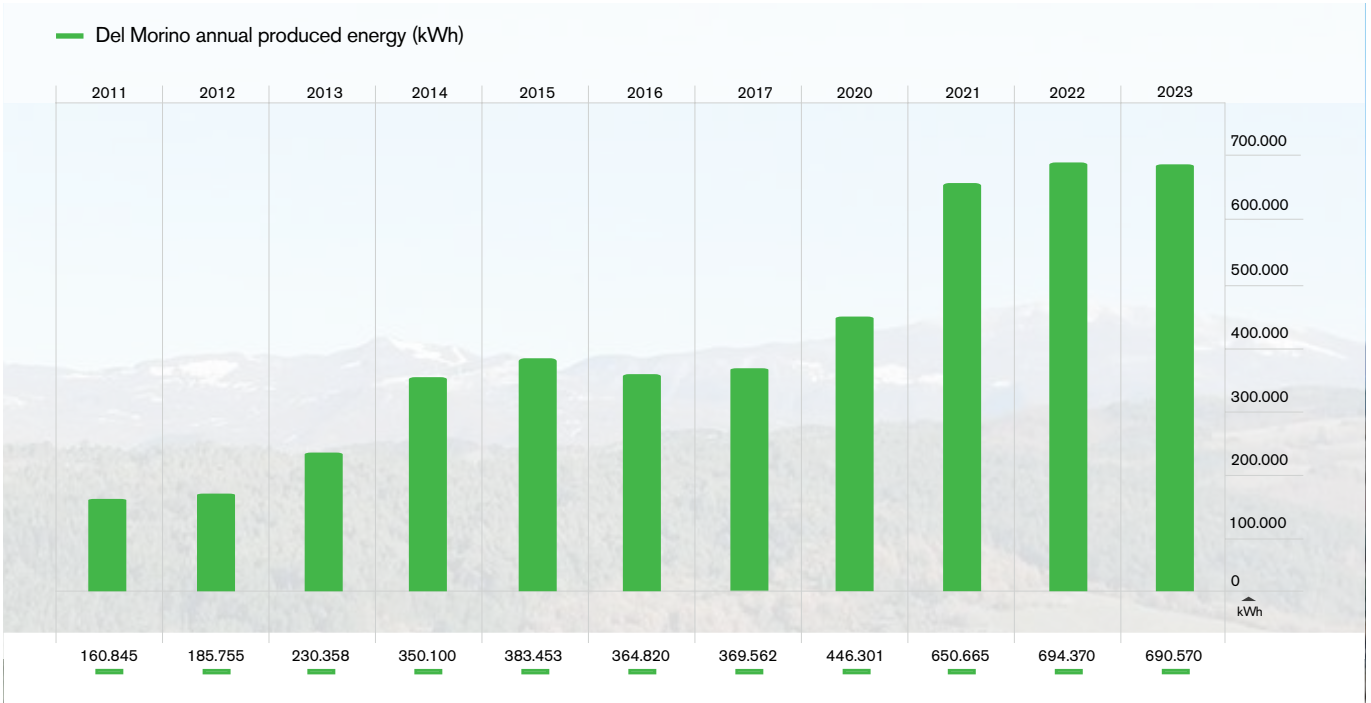



- First quality and certified materials.
- Matériaux certifiés de première qualité.
- Zertifizierte Materialien aus Erster Qualität.
- Materiali di prima qualità certificati.

- 3D Laser cutting machines of sheets and tubes.
- Machines pour découpe laser de tôle et tubes 3D.
- Laserschneidemaschinen für Bleche und 3D Rohre.
- Macchinari per taglio laser di lamiere e taglio tubi 3D.

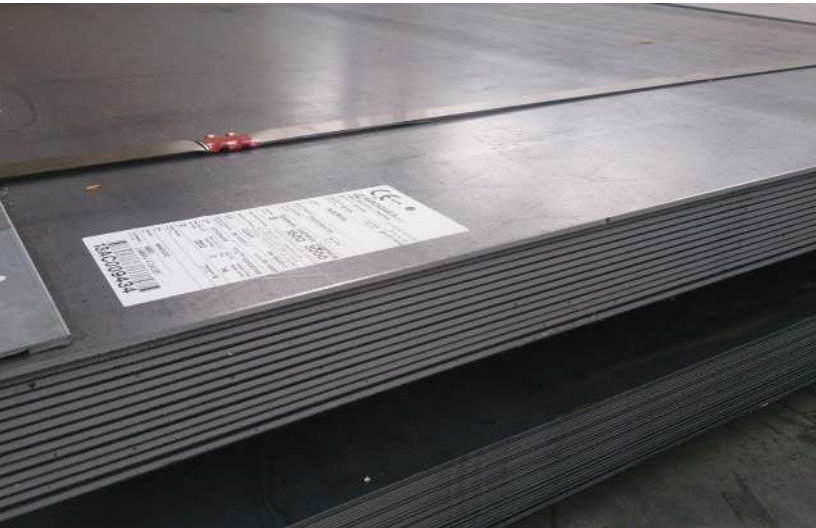

- Automatic bending machines with CNC control with robotic manipulators.
- Presses plieuses hydrauliques à contrôle numérique avec manipulateurs robotisés.
- Numerisch gesteuerte Biegemaschinen mit Robot Manipulatoren.
- Piegatrici automatiche a controllo numerico con manipolatori robotizzati.

- Numerically controlled robotic bending cell.
- Cellule robotisée de pliage à commandes numériques.
- Numerisch gesteuerte Roboter-Biegezone.
- Cella robotizzata di piegatura a controllo numerico.



- Lathe with CNC control.
- Tournures et enlèvement des copeaux avec CNC.
- Automatik Drehbank, CNC gesteuert.
- Torniture e lavorazioni di asportazione del truciolo con CNC.



- Automatic warehouses for pipes and ferrous materials.
- Gestion automatisée des tubes et des métaux ferreux.
- Automatische Lagern für Rohre und Eisenwerkstoffe.
- Magazzini automatici di tubi e materiali ferrosi.

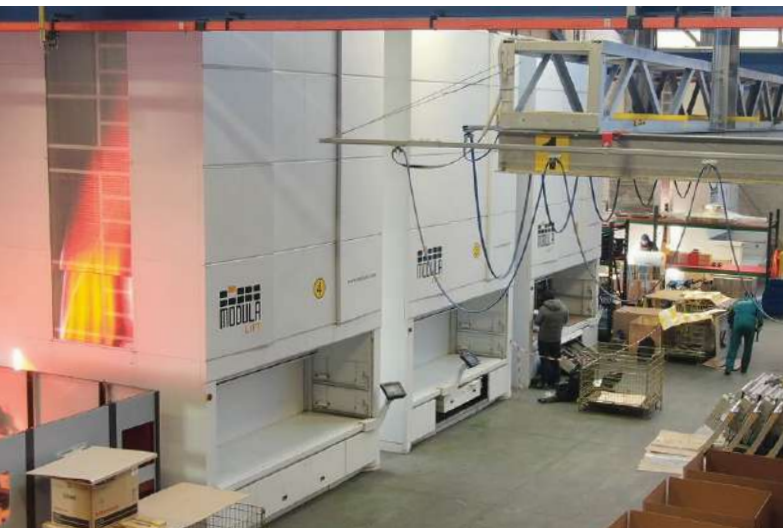

- Automatic parts warehouses.
- Gestion automatisée des stocks des pièces détachées et composants mécaniques.
- Automatische Ersatzteillagern.
- Magazzini automatici di ricambi e parti meccaniche.



- Rotors are made by robotic welding process.
- Roteurs réalisés avec soudure robotisée.
- Rotoren werden mit Schweißroboter hergestellt.
- Rotori realizzati in isole di saldatura robotizzate.



- Rotating elements balanced at operating speed with issue of a certificate.
- Éléments tournant équilibrés électroniquement à la vitesse d'utilisation avec délivrance du certificat.
- Drehende Teile werden bei der Arbeitsdrehzahl mit Zertifikat ausgewuchtet.
- Elementi rotanti equilibrati alla velocità di utilizzo e rilascio di certificato.

- Lathe with CNC control.
- Tournures et enlèvement des copeaux avec CNC.
- Automatik Drehbank, numerisch kontrolliert und gesteuert.
- Torniture e lavorazioni di asportazione del truciolo con CNC.



#### UNI EN ISO 14000 - OSHAS 8000

- Quality of environment in the factory in compliance with the norms.
- Qualité des lieux de travaille normalisés.
- Qualität der Arbeitsumgebung nach Normen.
- Qualità degli ambienti di lavoro normalizzati.

- Numerically controlled 5-axis milling machines.
- Machines à fraiser à 5 axes à commandes numériques.
- Numerisch gesteuerte 5-Achs-Fräsmaschinen.
- Fresatrici a 5 assi a controllo numerico.



- Automatic powder painting system, no noxious products used (lead, cadmium, etc).
- Machines robotisées pour vernissage, absence de produits nocifs (plomb, cadmium, etc).
- Automatische Pulver Lackiererei, ohne schädliche Mitteln (Blei, Kadmium, usw).
- Impianti di verniciatura robotizzati, assenza prodotti nocivi (piombo, cadmio, ecc).



- Assembly after painting, checks and tests in compliance with quality certification procedures.
- Assemblages post-vernissage, contrôles et essais selon des procédures de certification qualitative.
- Zusammenbau nach der Lackierung, Kontrollen und Prüfungen nach den Qualitätsrichtlinien.
- Assemblaggi post verniciatura, verifiche e collaudi secondo procedure di certificazione qualitativa.



- Packaging optimized to reduce plastic materials and optimize spaces.
- Optimisation des emballages pour réduire les matières plastiques et maximiser les espaces.
- Verpackung optimiert, um Kunststoffmaterialien zu reduzieren und Platz zu optimieren.
- Imballaggi ottimizzati per ridurre materiali plastici e spazi.

- Optimised loading to reduce transport costs and to simplify materials handling.
- Charges optimisés afin de réduire les coûts de transport et améliorer la logistique.
- Optimale Ladung um Transportkosten zu reduzieren und die Lasthandhabung zu vereinfachen.
- Carichi ottimizzati per ridurre costi di trasporto e facilitare la movimentazione.





# History – Histoire Kunstgeschichte – Storia

## Michelangelo Museum

Caprese Michelangelo is the birthplace of the famous artist. It is situated on the hills of wonderful Tuscany.

The Michelangelo Museum is located in the fortress above Caprese Michelangelo.

In 2006 the museum added a collection of small Italian sculptures to its treasures, which were donated by Professor Enrico Guidoni. The Museum's collection of art includes sculptures and drawings of Italian artists of 1800 and early 1900.

## Musee Michelangelesque

Caprese Michelangelo, village natal du célèbre artiste, se trouve parmi les collines de la belle Toscane.

Le Musée Michelangelesque est situé sur la forteresse de Caprese Michelangelo. Depuis 2006 le musée s'est enrichi d'une collection de petites sculptures italiennes offertes par le Prof. Enrico Guidoni, qui comprend sculptures et dessins d'artistes italiens de 1800 et début 1900.

## Michelangelo Museum

Caprese Michelangelo ist der Geburtsort, des berühmten Künstlers. Es liegt zwischen den malerischen Hügeln der schönen Toskana.

Das Museum Michelangelo liegt auf der Festung von Caprese Michelangelo. Seit 2006 konnte das Museum eine Kollektion kleiner italienischer Skulpturen dazu gewinnen, ein Geschenk von Enrico Guidoni. Die Kollektion besteht aus Gemälden und Skulpturen italienischer Künstler aus dem 1800 und frühen 1900.

## Museo Michelangiolesco

Caprese Michelangelo, paese natale del famoso artista, è situato tra le colline della bellissima Toscana.

Il Museo michelangiolesco ha sede presso la rocca di Caprese Michelangelo. Dal 2006, il museo si è arricchito di una collezione di piccole sculture italiane donata dal prof. Enrico Guidoni. La collezione comprende sculture e disegni di artisti italiani dell'Ottocento e dei primi del Novecento.







## *Environment – Milieu Umwelt – Ambiente*

### **Social responsibility & environment**

Del Morino S.r.l. is becoming a driving force behind the economic development of its territory. It is a living organism within the society where it operates and is continually engaged in safeguarding and furthering the fundamental values of mankind, the environment and the family. The social responsibility of Del Morino S.r.l. extends to the entire production process and all those who are included in it: from our workers to their families and our customers.

### **Responsabilité sociale & milieu**

La Del Morino S.r.l. représente de plus en plus une des forces motrices du développement économique du territoire. La maison Del Morino est une structure active dans son secteur, qui s'engage à la sauvegarde et au développement des valeurs fondamentales de la Personne, du Milieu et de la famille. La responsabilité sociale de la Del Morino S.r.l. est étendue à toute la chaîne de production: aux collaborateurs, aux familles et aux clients.

### **Soziale verantwortung und Umwelt**

Del Morino S.r.l. wird immer stärker zum Zugpferd für die ökonomische Entwicklung des eigenen Territoriums. Das Unternehmen ist ein lebender Organismus in der Gesellschaft in der es handelt und bemüht sich immerzu die fundamentalen Werte des Menschen, der Umwelt und der Familie zu schützen. Die soziale Verantwortlichkeit von Del Morino S.r.l. erstreckt sich über die gesamte Produktionskette und berücksichtigt alle: von Mitarbeitern über deren Familien bis hin zu unseren Kunden.

### **Responsabilità sociale & ambiente**

La Del Morino S.r.l. rappresenta sempre più una forza trainante per lo sviluppo economico del proprio territorio. Essa è organismo vivo nella società in cui opera e si impegna costantemente nella salvaguardia e nello sviluppo dei valori fondamentali dell'uomo, dell'ambiente e della famiglia. La responsabilità sociale della Del Morino S.r.l. si intende estesa a tutta la catena produttiva che essa alimenta: dai collaboratori ai familiari, ai clienti.

[www.capresemichelangelo.net](http://www.capresemichelangelo.net)







Del Morino





**Fixed rotary tiller**  
**Fraises fixes**  
**Feste Bodenfräsen**  
**Zappatrici fisse**



**Tango**

12 - 30 HP

85 / 105 / 125



**Flash**

12 - 25 HP

85 / 96 / 105 /  
125

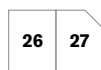

**Thunder**

12 - 40 HP

85 / 105 / 125 /  
145



**Eagle**

12 - 50 HP

85 / 105 / 125 /  
145 / 165



**URT HF**

30 - 70 HP

168 / 186 / 204 /  
222



**HRA**

50 - 95 HP

160 / 180 / 200 /  
225 / 250



**Side shift rotary tillers**  
**Fraises déportables**  
**Seitenverschiebbare Bodenfräsen**  
**Zappatrici spostabili**



**Holiday R**

15 - 40 HP

85 / 105 / 125 /  
145

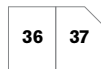

**Holiday RS**

15 - 50 HP

85 / 105 / 125 / 145



**URT ED**

20 - 50 HP

96 / 114 / 132 /  
150 / 160

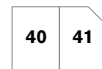



# Tango

Rotary tiller  
Fraise  
Bodenfräse  
Zappatrice

**HP**  
**12 - 30**

kW

9 - 22

rpm

540

 cm 15 - inch 6



ENG

Light rotary tiller suitable for low HP tractors. It is ideal for tilling small plots and gardens. Patented.

FRA

Fraise légère conçue pour tracteurs de faible puissance. Idéale pour cultiver de petites parcelles de terrain. Brevetée.

DEU

Leichte Bodenfräse, für Traktoren mit geringer Leistung geeignet. Ideal für die Bewirtschaftung kleinerer Grundstücke. Patentiert.

ITA

Zappatrice leggera adatta a trattori di piccola potenza. È ideale per coltivare piccoli appezzamenti di terra. Brevetato.

## STANDARD FEATURES

- 3 POINT HITCH CATEGORY 1
- ALUMINUM GEARBOX 540 RPM
- CHAIN TRANSMISSION ASA 80 WITH ADJUSTABLE TENSIONER
- ROTOR WITH 4 HOES PER FLANGE
- ADJUSTABLE REAR COVER
- ADJUSTABLE SKIDS
- SHEAR BOLT PTO SHAFT CATEGORY 2 - 700 MM

## CARACTÉRISTIQUES STANDARD

- ATTELAGE À 3 POINTS 1<sup>o</sup> CATÉGORIE
- BOITIER EN ALU 540 T/MIN
- TRANSMISSION PAR CHAÎNE ASA AVEC TENDEUR À RESSORT REGLABLE
- ROTOR 4 COUTEAUX PAR FLASQUE
- PANEAU ARRIÈRE RÉGLABLE
- PATINS REGLABLES
- CARDAN BOULON 2<sup>o</sup> CATÉGORIE - 700 MM





## STANDARD EIGENSCHAFTEN

- DREIPUNKTBOCK-ANSCHLUß KATEGORIE 1
- 540 U/MIN ALU-GETRIEBE
- ANTRIEB MIT 2 KEILRIEMEN UND EINSTELLBAREM SCHRAUBENSANNER
- ROTOR MIT 4 MESSER PRO FLANSCH
- VERSTELLBARER HINTERBLECH
- VERSTELLBARE KUFEN
- SCHERBOLZEN GELENKWELLE KATEGORIE 2 - 700 MM

## CARATTERISTICHE STANDARD

- ATTACCO A 3 PUNTI 1<sup>o</sup> CATEGORIA
- RIDUTTORE IN ALLUMINIO 540 G/MIN
- TRASMISSIONE CON CATENA ASA 80 CON TENDITORE A MOLLA
- DISPOSITIVO CONTROLLO COLTELLI DI SERIE
- ROTORE A 4 ZAPPE PER FLANGIA
- BANDELLA POSTERIORE REGOLABILE
- SLITTE REGOLABILI
- CARDANO BULLONE 2<sup>o</sup> CATEGORIA - 700 MM



COD-MOD	hp								€
		cm	in	cm	in				
<b>Tango 85</b>	<b>12 - 20</b>	<b>85</b>	<b>34"</b>	<b>100</b>	<b>40"</b>	<b>16</b>	<b>120</b>	<b>260</b>	
<b>Tango 105</b>	<b>12 - 30</b>	<b>105</b>	<b>42"</b>	<b>120</b>	<b>48"</b>	<b>20</b>	<b>130</b>	<b>290</b>	
<b>Tango 125</b>	<b>12 - 30</b>	<b>125</b>	<b>50"</b>	<b>140</b>	<b>56"</b>	<b>24</b>	<b>140</b>	<b>308</b>	

**DIMENSIONS - DIMENSIONS - ABMESSUNGEN - INGOMBRI**

Type	A (cm)	B (cm)	C (cm)
Tango 85	120	80	90
Tango 105	140	80	90
Tango 125	160	80	90

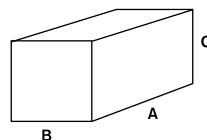

**PACKAGING - EMBALLAGE - VERPACKUNG - IMBALLAGGI**



- Single metal crate

---

- Caisse Métallique unitaire

---

- Einzelne Metall Palette

---

- Cassa singola

---



# Flash

Rotary tiller & stone burier

Fraise & enfouisseuse

Bodenfräse & Bodenumkehrfräse

Zappatrice e interrassasi

HP

12 - 25

kW

10 - 20

rpm

540

 cm 16 - inch 6



ENG

Since it is very easy to use this machine can satisfy the expectations of semi-professional farmers to achieve a perfect tilling of small plots of land or in the field of horticulture.

FRA

En considérant la facilité d'utilisation la FLASH est indiquée pour satisfaire les exigences des utilisateurs semi professionnels pour un parfait freisage des petites parcelles de terrains ou dans le domain de l'horticulture.

DEU

In Anbetracht ihrer Benutzerfreundlichkeit, ist FLASH besonders dafür geeignet, auch die Notwendigkeiten von Halbprofibauern zu befriedigen, und zwar zum perfekten Fräsen von kleinen Grundstücken oder vom Gartenbau.

ITA

Data la semplicità di utilizzo, è adatta a soddisfare le esigenze anche di agricoltori semi-professionisti per una perfetta fresatura di piccoli appezzamenti di terreno o nel campo della orticoltura.

## STANDARD FEATURES

- 3 POINT HITCH, CATEGORY 1, SIDE SHIFT
- TWO COMER GEARBOXES, VERTICAL TRANSMISSION WITH SHEAR BOLT PROTECTION
- ROTOR WITH 4 HOES PER FLANGE
- ADJUSTABLE SKIDS
- UNIVERSAL PTO SHAFT FOR POSITION CATEGORY 1 - 700 MM

## CARACTÉRISTIQUES STANDARD

- ATTELAGE DÉPORTABLE PAR POSITIONS À 3 POINTS 1° CATÉGORIE
- TRANSMISSION PAR ARBRE HEXAGONAL AVEC DEUX BOÎTIERS SURPOSÉS
- DISPOSITIF DE SÉCURITÉ INTÉGRÉ AVEC BOULON DE CISAILLEMENT
- ROTOR AVEC 4 COUTEAUX PAR FLASQUE
- PATINS RÉGLABLES
- CARDAN STANDARD 1° CATÉGORIE - 700 MM

## STANDARD EIGENSCHAFTEN

- DREIPUNKTBOCK. ANSCHLUß KATEGORIE 1, SEITENVERSCHIEBUNG
- ZWEI COMER GETRIEBE ÜBEREINANDER
- GESCHÜTZT VON EIN SICHERHEITSBOLZEN DER GUT ERREICHBAR ZWISCHEN DEN GETRIEBEN SITZT
- ROTOR MIT 4 MESSER PRO FLANSCH
- VERSTELLBARE KUFEN
- STANDARD GELENKWELLE KATEGORIE 1 - 700 MM

## CARATTERISTICHE STANDARD

- ATTACCO A 3 PUNTI DI 1° CATEGORIA SPOSTABILE PER POSIZIONI
- TRASMISSIONE VERTICALE AD INGRANAGGI, 2 RIDUTTORI SOVRAPPOSTI
- DISPOSITIVO DI SICUREZZA INTEGRATO CON BULLONE DI TRANCIO
- ROTORE CON 4 ZAPPE PER FLANGIA AD ELICA
- SLITTE REGOLABILI
- CARDANO STANDARD 1° CATEGORIA - 700 MM



COD-MOD	hp								€
		cm	in	cm	in		kg	lbs	
<b>Flash 85</b>	12 - 25	85	34"	100	39"	16	118	260	
<b>Flash 96</b>	12 - 25	96	38"	110	43"	20	128	282	
<b>Flash 105</b>	12 - 25	105	42"	120	47"	20	130	287	
<b>Flash 125</b>	12 - 25	125	50"	140	55"	24	140	309	

Cod.	OPTIONAL	€
------	----------	---



**R**

Reverse of the rotation direction  
 Reverse - inversion du sens de rotation du rotor  
 Umkehrfräse - Umkehr der Rotordrehrichtung  
 Reverse - inversione del senso di rotazione del rotore

Cod.	Type	kg	€
------	------	----	---



**KI**

Stone burier kit  
 Kit enfouisseuse  
 Bodenumkehrfräse kit  
 Kit interrassasi

Flash 85	21
Flash 96	22
Flash 105	22
Flash 125	24

Cod.	Type	kg	€
------	------	----	---



**GA**

Cage roller  
 Rouleau cage avec tuyaux  
 Walze mit Rohren  
 Rullo con tubi

Flash 85	33
Flash 96	38
Flash 105	38
Flash 125	41

Cod.	Type	kg	€
------	------	----	---



**GR**

Wire roller  
 Rouleau avec tôle grillée  
 Walze mit Gitterblech  
 Rullo con lamiera grigliata

Flash 85	45
Flash 96	53
Flash 105	55
Flash 125	57

**DIMENSIONS - DIMENSIONS - ABMESSUNGEN - INGOMBRI**

Type	A (cm)	B (cm)	C (cm)
Flash 65	120	80	90
Flash 85	120	80	90
Flash 96	120	80	90
Flash 105	140	80	90
Flash 125	160	80	90

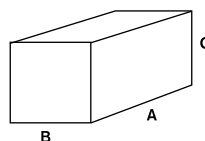

**PACKAGING - EMBALLAGE - VERPACKUNG - IMBALLAGGI**



- Single metal crate
- Caisse métallique unitaire
- Einzelne Metall Palette
- Cassa singola



# Thunder

Rotary tiller & Reverse

Fraise & Reverse

Bodenfräse & Reverse

Zappatrice e Reverse

HP

12 - 40

kW

10 - 30

rpm

540



cm 15 - inch 6



ENG

Easy to use machine for small to medium plots. For deeper penetration of the ground the reverse configuration is recommended.

FRA

Machine simple pour un travail de qualité, même en profondeur, de petites et moyennes parcelles de terrain. Il est conseillé de configurer la version "reverse" pour une importante pénétration du terrain.

DEU

Diese Maschine ist für die Bearbeitung von kleinen und Mittleren Flächen (auch in die Tiefe) geeignet. Um tiefer in den Boden einzudringen wird die Umkehr-Ausführung empfohlen.

ITA

Macchina semplice per lavorazioni anche in profondità di piccole e medie superfici. È consigliata la configurazione Reverse per importanti penetrazioni del terreno.

## STANDARD FEATURES

- 3 POINT HITCH, CATEGORY 1
- CAST IRON GEARBOX 540 RPM
- CHAIN DRIVE ASA 80 IN OIL BATH WITH AUTOMATIC TENSIONER
- ROTOR WITH 4 HOES PER FLANGE
- ADJUSTABLE SKIDS
- UNIVERSAL PTO SHAFT CATEGORY 4 - 700 MM
- "REVERSE" CONFIGURATION

## CARACTÉRISTIQUES STANDARD





- ATTELAGE À 3 POINTS 1°CATÉGORIE
- BOITIER EN FONTE 540 T/MIN
- TRANSMISSION PAR CHAÎNE ASA 80 EN BAIN D'HUILE AVEC TENDEUR AUTOMATIQUE
- ROTOR 4 COUTEAUX PAR FLASQUE
- PATINS RÉGLABLES
- CARDAN STANDARD 4° CATÉGORIE - 700 MM
- VERSION RÉVERSIBLE ROTATION CONTRAIRE

## STANDARD EIGENSCHAFTEN

- DREIPUNKTBOCK-ANSCHLUß KATEGORIE 1
- GUSSEISENES GETRIEBE 540 U/MIN (OHNE FREILAUF)
- KETTENANTRIEB IN ÖLBAD MIT AUTOMATISCHER KETTENSPELLER ASA 80
- ROTOR MIT 4 MESSER PRO FLANSCH
- VERSTELLBARE KUFEN
- STANDARD GELENKWELLE KATEGORIE 4 - 700 MM
- REVERSE KONFIGURATION

## CARATTERISTICHE STANDARD

- ATTACCO A 3 PUNTI DI 1° CATEGORIA
- RIDUTTORE IN GHISA 540 G/MIN
- TRASMISSIONE A CATENA ASA 80 IN BAGNO D'OLIO CON TENDITORE AUTOMATICO
- ROTORE CON 4 ZAPPE PER FLANGIA
- SLITTE REGOLABILI
- CARDANO STANDARD 4° CATEGORIA - 700 MM
- CONFIGURABILE REVERSIBILE

COD-MOD	hp					n.			€
		cm	in	cm	in				
<b>Thunder 85</b>	12 - 40	85	34"	100	40"	16	154	340	
<b>Thunder 105</b>	12 - 40	105	42"	120	48"	20	166	366	
<b>Thunder 125</b>	12 - 40	125	50"	140	56"	24	180	397	
<b>Thunder 145</b>	12 - 40	145	58"	160	64"	28	193	425	

Cod.	OPTIONAL	€
------	----------	---



**R**  
*Reverse of the rotation direction*  
*Reverse - inversion du sens de rotation du rotor*  
*Umkehrfräse - Umkehr der Rotordrehrichtung*  
*Reverse - inversione del senso di rotazione del rotore*

Cod.	Type	Kg	€
	Thunder 85	21	
	Thunder 105	22	
	Thunder 125	22	
	Thunder 145	24	

**KI**  
*Stone burier kit*  
*Kit Enfouisseuse*  
*Bodenumkehrfräse kit*  
*Kit interrassasi*

Cod.	€
------	---



**F**  
*Slip clutch PTO shaft*  
*Dispositif de sécurité à friction inclus dans le cardan*  
*Kupplungssicherung im Kardan enthalten*  
*Dispositivo di sicurezza a frizione incluso nel cardano*

Cod.	€
------	---



**B**  
*Shear bolt PTO shaft*  
*Dispositif de sécurité à boulon inclus dans le cardan*  
*Sicherheitsvorrichtung mit Bruchbolzen im Kardan enthalten*  
*Dispositivo di sicurezza con bullone di rottura incluso nel cardano*

**DIMENSIONS - DIMENSIONS - ABMESSUNGEN - INGOMBRI**

Type	A (cm)	B (cm)	C (cm)
Thunder 85	120	80	95
Thunder 105	125	80	95
Thunder 125	145	80	95
Thunder 145	165	80	95

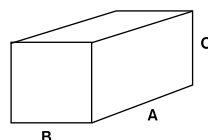

**PACKAGING - EMBALLAGE - VERPACKUNG - IMBALLAGGI**

- Single metal crate
- Caisse métallique unitaire
- Einzelne Metall Palette
- Cassa singola





# Eagle

Fixed rotary tiller

Fraise fixe

Feste Bodenfräse

Zappatrice fissa

HP

12 - 50

kW

10 - 40

rpm

540

 cm 16 - inch 6



ENG

This rotary tiller combines style, functionality and power to break up the ground. It can optionally be supplied with 6 hoes per flange for even better results.

FRA

Fraise qui conjugue fonctionnement, style et puissance dans l'ermiettement de terre. Cette machine peut être configurée sur demande avec 6 couteaux par flasque pour un surprenant résultat final.

DEU

Diese Bodenfräse verbindet Stil, Zweckmäßigkeit und Kraft um den Boden aufzubrechen. Wahlweise kann es mit 6 Messer pro Flansch ausgestattet werden um noch bessere Ergebnisse zu erreichen.

ITA

Fresa che coniuga funzionalità, stile e potenza nella rottura del terreno. Su richiesta può essere configurata con 6 zappe per flangia per un esito migliore.

## STANDARD FEATURES

- 3 POINT HITCH, CATEGORY 1
- ONE PIECE, 4 MM STEEL FRAME
- CAST IRON GEARBOX 540 RPM
- CHAIN DRIVE ASA 80 IN OIL BATH WITH AUTOMATIC TENSIONER
- ROTOR WITH 4 HOES PER FLANGE  
OPTIONAL 6 HOES PER FLANGE
- SIDE SHIFT THROUGH MOVEABLE 3 POINT HITCH COUPLINGS
- ADJUSTABLE SKIDS
- UNIVERSAL PTO SHAFT CATEGORY 4 - 700 MM

## CARACTÉRISTIQUES STANDARD





- ATTELAGE À 3 POINTS 1° CATÉGORIE
- CHÂSSIS MONOCOQUE ÉPAISSEUR 4 MM
- BOÎTIER EN FONTE 540 T/MIN
- TRANSMISSION PAR CHAÎNE ASA 80 EN BAIN D'HUILE AVEC TENDEUR AUTOMATIQUE
- ROTOR 4 COUTEAUX PAR FLASQUE. KIT 6 COUTEAUX EN OPTION
- DÉPLACEMENT LATÉRAL POUR L'ATTELAGE AU DISPOSITIF DE RELEVAGE
- PATINS RÉGLABLES
- CARDAN STANDARD 4° CATÉGORIE - 700 MM

## STANDARD EIGENSCHAFTEN

- DREIPUNKTBOCK-ANSCHLUß KATEGORIE 1
- RAHMEN AUS 4MM STAHL
- GUSSEISENES GETRIEBE 540 U/MIN
- KETTENANTRIEB ASA 80 IN ÖLBAD MIT AUTOMATISCHER KETTENSPELLER
- ROTOR MIT 4 MESSER PRO FLANSCH, 6 MESSER PRO FLANSCH ALS ZUBEHÖR
- SEITENVERSCHIEBUNG DURCH ANSCHLÜSSE AM HEBER
- VERSTELLBARE KUFEN
- STANDARD GELENKWELLE KATEGORIE 4 - 700 MM

## CARATTERISTICHE STANDARD

- ATTACCO A 3 PUNTI DI 1° CATEGORIA
- TELAIO MONOCOCCA SPESSORE 4 MM
- RIDUTTORE IN GHISA 540 G/MIN
- TRASMISSIONE A CATENA ASA 80 IN BAGNO D'OLIO CON TENDITORE AUTOMATICO
- ROTORE CON 4 ZAPPE PER FLANGIA. KIT 6 ZAPPE IN OPZIONE
- SPOSTAMENTO LATERALE TRAMITE ATTACCHI AL SOLLEVATORE SPOSTABILI
- SLITTE REGOLABILI
- CARDANO STANDARD 4° CATEGORIA - 700 MM

COD-MOD	hp								€
		cm	in	cm	in				
<b>Eagle 85</b>	12 - 50	85	34"	100	40"	16	159	351	
<b>Eagle 105</b>	12 - 50	105	42"	120	48"	20	178	392	
<b>Eagle 125</b>	12 - 50	125	50"	140	56"	24	188	414	
<b>Eagle 145</b>	12 - 50	145	58"	160	64"	28	206	454	
<b>Eagle 165</b>	12 - 50	165	62"	180	72"	32	223	492	

Cod.	OPTIONAL	Type	€
	<b>Z</b> <i>N° 6 hoes per flange N. 6 couteaux par chaque flasque du rotor Montage von 6 Messern auf jedem Rotorflansch Montaggio di n° 6 zappe su ogni flangia del rotore</i>	Eagle 85	
		Eagle 105	
		Eagle 125	
		Eagle 145	
		Eagle 165	

Cod.	€
------	---



**F**

*Slip clutch PTO shaft  
Dispositif de sécurité à friction inclus dans le cardan  
Kupplungssicherung im Kardan enthalten  
Dispositivo di sicurezza a frizione incluso nel cardano*

Cod.	€
------	---



**B**

*Shear bolt PTO shaft  
Dispositif de sécurité à boulon inclus dans le cardan  
Sicherheitsvorrichtung mit Bruchbolzen im Kardan enthalten  
Dispositivo di sicurezza con bullone di rottura incluso nel cardano*

**DIMENSIONS - DIMENSIONS - ABMESSUNGEN - INGOMBRI**

Type	A (cm)	B (cm)	C (cm)
Eagle 85	120	80	95
Eagle 105	125	80	95
Eagle 125	145	80	95
Eagle 145	165	80	95
Eagle 165	185	80	95

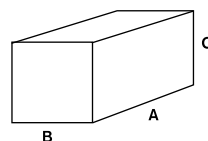

**PACKAGING - EMBALLAGE - VERPACKUNG - IMBALLAGGI**



- Single metal crate
- Caisse métallique unitaire
- Einzelne Metall Palette
- Cassa singola



# URT HF

Fixed rotary tiller

Fraise fixe

Feste Bodenfräse

Zappatrice fissa

## HP

### 30 - 70

kW

30 - 50

rpm

540

 cm 19 - inch 8



ENG

This machine demonstrates Del Morino's experience in both the quality of construction and the final result in the field. It is suitable for the professional farmer working in open fields.

FRA

Cette machine représente dans sa technique constructive l'expérience de la Del Morino soit dans la qualité des matériaux que dans ses résultats. Il s'agit d'une machine indiquée pour les agriculteurs professionnels et pour les travaux dans des terrains labourés.

DEU

Diese Bodenfräse zeigt die Erfahrung von Del Morino sowohl beim Konzept wie auch bei den Ergebnissen. Es ist für Profi Bauern in offenen Felder bestens geeignet.

ITA

Questa macchina rappresenta nella sua tecnica costruttiva l'esperienza della Del Morino sia nella qualità dei materiali, sia nei risultati. Questa è una macchina indicata per gli agricoltori professionali e per i lavori in campo aperto.

#### STANDARD FEATURES

- 3 POINT HITCH, CATEGORY 2
- CAST IRON GEARBOX 540 RPM
- CHAIN DRIVE ASA 100 IN OIL BATH WITH AUTOMATIC TENSIONER
- ROTOR WITH 4 HOES PER FLANGE
- OPTIONAL WITH 6 HOES PER FLANGE
- ADJUSTABLE SKIDS
- UNIVERSAL PTO SHAFT, CATEGORY 4 - 700 MM
- FRONT REINFORCEMENT BAR

#### CARACTÉRISTIQUES STANDARD





- ATTELAGE À 3 POINTS 2<sup>e</sup> CATÉGORIE.
- BOITIER EN FONTE 540 T/MIN
- TRANSMISSION À CHAÎNE A BAIN D'HUILE ASA 100 AVEC TENDEUR AUTOMATIQUE
- ROTOR AVEC 4 COUTEAUX PAR FLASQUE
- PRÉDISPOSITION KIT 6 COUTEAUX PAR FLASQUE
- PATINS RÉGLABLES
- CARDAN STANDARD 4<sup>e</sup> CATÉGORIE - 700 MM
- RENFORT FRONTAL

#### STANDARD EIGENSCHAFTEN

- DREIPUNKTBOCK-ANSCHLUß KATEGORIE 2
- GUSSEISENES GETRIEBE 540 U/MIN
- KETTENANTRIEB IN ÖLBAD MIT AUTOMATISCHER KETTENSANNER ASA 100
- ROTOR MIT 4 MESSER PRO FLANSCH
- 6 MESSER PRO FLANSCH ALS ZUBEHÖR
- VERSTELLBARE KUFEN
- STANDARD GELENKWELLE KATEGORIE 4 - 700 MM
- VORDER VERSTÄRKUNGSSTANGE

#### CARATTERISTICHE STANDARD

- ATTACCO A 3 PUNTI DI 2<sup>a</sup> CATEGORIA
- RIDUTTORE IN GHISA 540 G/MIN
- TRASMISSIONE A CATENA ASA 100 IN BAGNO D'OLIO CON TENDITORE AUTOMATICO
- ROTORE CON 4 ZAPPE PER FLANGIA
- PREDISPOSIZIONE KIT 6 ZAPPE PER FLANGIA
- SLITTE REGOLABILI
- CARDANO STANDARD 4<sup>a</sup> CATEGORIA - 700 MM
- BARRA DI RINFORZO FRONTALE

COD-MOD	hp								€
		cm	in	cm	in				
<b>URT HF 150</b>	<b>30 - 70</b>	<b>150</b>	<b>59"</b>	<b>160</b>	<b>63"</b>	<b>32</b>	<b>290</b>	<b>640</b>	
<b>URT HF 168</b>	<b>30 - 70</b>	<b>168</b>	<b>67"</b>	<b>180</b>	<b>72"</b>	<b>36</b>	<b>320</b>	<b>705</b>	
<b>URT HF 186</b>	<b>30 - 70</b>	<b>186</b>	<b>71"</b>	<b>200</b>	<b>80"</b>	<b>40</b>	<b>330</b>	<b>728</b>	
<b>URT HF 204</b>	<b>30 - 70</b>	<b>204</b>	<b>81"</b>	<b>220</b>	<b>88"</b>	<b>44</b>	<b>362</b>	<b>798</b>	
<b>URT HF 222</b>	<b>30 - 70</b>	<b>222</b>	<b>96"</b>	<b>240</b>	<b>96"</b>	<b>48</b>	<b>381</b>	<b>840</b>	

Cod.	OPTIONAL	Type	€
	<b>Z</b> <i>N° 6 hoes per flange N. 6 couteaux par chaque flasque du rotor Montage von 6 Messern auf jedem Rotorflansch Montaggio di n° 6 zappe su ogni flangia del rotore</i>	Urt Hf 150	
		Urt Hf 168	
		Urt Hf 186	
		Urt Hf 204	
		Urt Hf 222	

Cod.		€
	<b>F</b> <i>Slip clutch PTO shaft Dispositif de sécurité à friction inclus dans le cardan Kupplungssicherung im Kardan enthalten Dispositivo di sicurezza a frizione incluso nel cardano</i>	

Cod.		€
	<b>B</b> <i>Shear bolt PTO shaft Dispositif de sécurité à boulon inclus dans le cardan Sicherheitsvorrichtung mit Bruchbolzen im Kardan enthalten Dispositivo di sicurezza con bullone di rottura incluso nel cardano</i>	

**DIMENSIONS - DIMENSIONS - ABMESSUNGEN - INGOMBRI**

Type	A (cm)	B (cm)	C (cm)
URT HF 168	<b>180</b>	<b>80</b>	<b>95</b>
URT HF 186	<b>200</b>	<b>80</b>	<b>95</b>
URT HF 204	<b>220</b>	<b>80</b>	<b>95</b>
URT HF 222	<b>240</b>	<b>80</b>	<b>95</b>

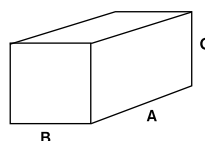

**IMBALLAGE - VERPACKUNG - IMBALLAGGI**

- Single metal crate
- Caisse métallique unitaire
- Einzelne Metall Palette
- Cassa singola



# HRA

Fixed rotary tiller

Fraise fixe

Feste Bodenfräse

Zappatrice fissa

## HP

### 50 - 95

kW

40 - 70

rpm

540

 cm 23 - inch 9



ENG

This rotary tiller is suitable for heavy tilling thanks to the strength and elasticity of the components used in its construction.

FRA

Il s'agit d'une machine indiquée pour les travaux en profondeur grâce à la résistance et l'élasticité en ce qui concerne les matériaux utilisés afin d'éviter la surcharge des mécanismes et les ruptures accidentelles.

DEU

Diese Bodenfräse ist durch seine starken und elastischen Bauteile für tiefe Bodenbearbeitung geeignet.

ITA

Adatta a lavorazioni profonde anche grazie alla grande resistenza ed elasticità dei materiali impiegati per evitare inconvenienti di surriscaldamento dei cinematismi e le rotture accidentali.

#### STANDARD FEATURES

- 3 POINT HITCH, CATEGORY 2
- CAST IRON GEARBOX 540 RPM, SINGLE SPEED
- CHAIN DRIVE ASA 100 IN OIL BATH WITH AUTOMATIC TENSIONER
- ROTOR WITH 6 HOES PER FLANGE
- ADJUSTABLE SKIDS
- ADJUSTABLE LOWER ARM ATTACHMENT POINTS
- UNIVERSAL PTO SHAFT, CATEGORY 5, WITH SLIP CLUTCH - 1200 MM
- REINFORCED THREE POINT HITCH FRAME

#### CARACTÉRISTIQUES STANDARD





- ATTELAGE À 3 POINTS 2° CATÉGORIE
- BOITIER EN FONTE 540 T/MIN MONOVITESSE
- TRANSMISSION PAR CHAÎNE A BAIN D'HUILE AVEC TENDEUR AUTOMATIQUE
- ROTOR AVEC 6 COUTEAUX PAR FLASQUE
- PATINS RÉGLABLES
- ATTELAGES À L'ÉLÉVATEUR RÉGLABLES EN LARGEUR
- CARDAN 5° CATÉGORIE AVEC FRICTION DE SÉCURITÉ - 1200 MM
- BARRE DE RENFORCEMENT FRONTALE

#### STANDARD EIGENSCHAFTEN

- DREIPUNKTBOCK-ANSCHLUß KATEGORIE 2
- GUSSEISENES GETRIEBE 540 U/MIN, 1-GANG (ROTOR DREHZAHL 190 U/MIN)
- KETTENANTRIEB ASA 100 IN ÖLBAD MIT AUTOMATISCHER KETTENSPELLER
- ROTOR MIT 6 MESSER PRO FLANSCH
- VERSTELLBARE KUFEN
- HEBER ANSCHLÜSSE IN DER BREITE VERSTELLBAR
- GELENKWELLE KATEGORIE 5 MIT RUTSCHKUPPLUNG - 1200 MM
- VERSTÄRKTEM ANBAUBOCK

#### CARATTERISTICHE STANDARD

- ATTACCO A 3 PUNTI DI 2° CATEGORIA
- RIDUTTORE IN GHISA 540 G/MIN MONOVELOCITÀ
- TRASMISSIONE A CATENA ASA 100 BAGNO D'OLIO CON TENDITORE AUTOMATICO
- ROTORE CON 6 ZAPPE PER FLANGIA
- SLITTE REGOLABILI
- ATTACCHI AL SOLLEVATORE REGISTRABILI IN LARGHEZZA
- CARDANO 5° CATEGORIA, SICUREZZA FRIZIONE - 1200 MM
- BARRA DI RINFORZO FRONTALE

COD-MOD	hp								€
		cm	in	cm	in				
<b>HRA 160</b>	<b>50 - 95</b>	<b>160</b>	<b>63"</b>	<b>185</b>	<b>74"</b>	<b>42</b>	<b>531</b>	<b>1171</b>	
<b>HRA 180</b>	<b>50 - 95</b>	<b>180</b>	<b>72"</b>	<b>210</b>	<b>84"</b>	<b>48</b>	<b>566</b>	<b>1248</b>	
<b>HRA 200</b>	<b>50 - 95</b>	<b>200</b>	<b>81"</b>	<b>230</b>	<b>92"</b>	<b>54</b>	<b>604</b>	<b>1132</b>	
<b>HRA 225</b>	<b>50 - 95</b>	<b>225</b>	<b>90"</b>	<b>250</b>	<b>100"</b>	<b>60</b>	<b>642</b>	<b>1415</b>	
<b>HRA 250</b>	<b>50 - 95</b>	<b>250</b>	<b>100"</b>	<b>275</b>	<b>110"</b>	<b>66</b>	<b>690</b>	<b>1521</b>	

Cod.	OPTIONAL	€
------	----------	---



I

*Gear side transmission  
Dispositif de transmission latéral à engrenages  
Räderwerk Antrieb  
Dispositivo di trasmissione laterale a ingranaggi*

**DIMENSIONS - DIMENSIONS - ABMESSUNGEN - INGOMBRI**

Type	A (cm)	B (cm)	C (cm)
HRA 160	190	90	110
HRA 180	210	90	110
HRA 200	230	90	110
HRA 225	255	90	110
HRA 250	280	90	110

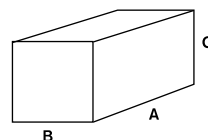

**PACKAGING - EMBALLAGE - VERPACKUNG - IMBALLAGGI**



- Single metal crate
- Caisse métallique unitaire
- Einzelne Metall Palette
- Cassa singola



# Holiday R

Side shift rotary tillers

Fraises déportable

Seitenverschiebbare Bodenfräsen

Zappatrice spostabile

HP

15 - 40

kW

12 - 30

rpm

540

 cm 15 - inch 6



ENG

This machine is suitable for tilling in orchards or tree farms. The side shift permits tilling close to the tree trunks. It is suitable for small to medium HP tractors.

FRA

Machine destinée dans les vergers ou dans les cultures de petits arbres. Son déplacement latéral permet à l'opérateur de rapprocher la fraise aux cultures sans les endommager. Elle est indiquée pour les tracteurs de petite et moyenne puissance.

DEU

Diese Bodenfräse ist für Obstbau und Baumschulen geeignet, dank seiner Seitenverschiebung wodurch ganz Nah bei den Bäumen gefräst werden kann. Es ist für Klein und Mittelstarken Taktoren geeignet.

ITA

Macchina indicata per lavorazioni in frutteti o colture ad alberello, grazie allo spostamento laterale l'operatore può avvicinare la fresa alle colture senza danneggiarle. Adatta a trattori di piccole e medie potenze.

## STANDARD FEATURES

- 3 POINT HITCH, CATEGORY 1 AND 2
- CAST-IRON GEARBOX 540 RPM
- SIDE CHAIN ASA 80 RUNNING IN OIL BATH WITH AUTOMATIC TENSIONER
- ROTOR WITH 4 HOES PER FLANGE
- ADJUSTABLE SKIDS
- MANUAL SIDE SHIFT
- UNIVERSAL PTO SHAFT CATEGORY 4 - 700 MM

## CARACTÉRISTIQUES STANDARD

- ATTELAGE À 3 POINTS 1° ET 2° CATÉGORIE
- BOITIER EN FONTE 540 T/MIN
- TRANSMISSION PAR CHAÎNE ASA 80 A BAIN D'HUILE AVEC TENDEUR AUTOMATIQUE
- ROTOR AVEC 4 COUTEAUX PAR FLASQUE
- PATINS RÉGLABLES
- DÉPLACEMENT LATÉRAL MANUEL
- CARDAN STANDARD 4° CATÉGORIE - 700 MM

## STANDARD EIGENSCHAFTEN

- DREIPUNKTBOCK-ANSCHLUß KATEGORIE 1 UND 2
- GUSSEISENENES GETRIEBE 540 U/MIN
- KETTENANTRIEB ASA 80 IN ÖLBAD MIT AUTOMATISCHER KETTENSPELLER
- ROTOR MIT 4 MESSER PRO FLANSCH
- VERSTELLBARE KUFEN
- MECHANISCHER SEITENVERSCHIEBUNG
- STANDARD GELENKWELLE KATEGORIE 4 - 700 MM

## CARATTERISTICHE STANDARD

- ATTACCO A 3 PUNTI DI 1° E 2° CATEGORIA
- RIDUTTORE IN GHISA 540 G/MIN
- TRASMISSIONE A CATENA ASA 80 IN BAGNO D'OLIO CON TENDITORE AUTOMATICO
- ROTORE CON 4 ZAPPE PER FLANGIA
- SLITTE REGOLABILI
- SPOSTAMENTO LATERALE MANUALE
- CARDANO STANDARD 4° CATEGORIA - 700 MM

COD-MOD	hp								€
		cm	in	cm	in				
<b>Holiday R 85</b>	15 - 40	85	34"	105	42"	16	139	306	
<b>Holiday R 105</b>	15 - 40	105	42"	125	50"	20	152	335	
<b>Holiday R 125</b>	15 - 40	125	50"	145	58"	24	167	368	
<b>Holiday R 145</b>	15 - 40	145	58"	165	66"	28	188	414	

Cod.	OPTIONAL	€
------	----------	---



**V**

*Side shift by screw  
Dispositif de déport par vis du troisième point  
Spindelverschiebung vom PTO  
Dispositivo di spostamento a vite dell'attacco a tre punti*

Cod.	€
------	---



**F**

*Slip clutch PTO shaft  
Dispositif de sécurité à friction inclus dans le cardan  
Kupplungssicherung im Kardan enthalten  
Dispositivo di sicurezza a frizione incluso nel cardano*

Cod.	€
------	---



**B**

*Shear bolt PTO shaft  
Dispositif de sécurité à boulon inclus dans le cardan  
Sicherheitsvorrichtung mit Bruchbolzen im Kardan enthalten  
Dispositivo di sicurezza con bullone di rottura incluso nel cardano*

**DIMENSIONS - DIMENSIONS - ABMESSUNGEN - INGOMBRI**

Type	A (cm)	B (cm)	C (cm)
Holiday R 85	120	80	90
Holiday R 105	125	80	90
Holiday R 125	145	80	90
Holiday R 145	165	80	90

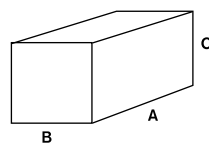

**PACKAGING - EMBALLAGE - VERPACKUNG - IMBALLAGGI**



- Single metal crate
- Caisse métallique unitaire
- Einzelne Metall Palette
- Cassa singola



# Holiday RS

Side shift rotary tiller

Fraise déportable

Seitenverschiebbare Bodenfräse

Zappatrice spostabile

HP

15 - 50

kW

12 - 40

rpm

540



cm 16 - inch 7



ENG

This machine is suitable for tilling in orchards or tree farms. The side shift allows to till close to tree trunks. It is suitable for medium HP tractors.

FRA

Machine professionnelle avec châssis renforcé indiquée pour les travaux en profondeur dans les vergers ou dans les vignobles. Son déplacement latéral permet à l'opérateur de rapprocher la fraise aux cultures sans les endommager. Elle est indiquée pour les tracteurs de moyenne puissance.

DEU

Diese Bodenfräse hat ein verstärkten Rahmen und ist für Obst- und Weinbau geeignet. Dank seiner Seitenverschiebung kann es ganz Nah an den Bäumen und Sträuchern arbeiten. Es ist für Mittelstarken Traktoren geeignet.

ITA

Macchina professionale e con telaio scatolato per lavorazioni profonde in frutteti e vigneti, grazie allo spostamento laterale l'operatore può avvicinare la fresa alle colture senza danneggiarle. Adatta a trattori di medie potenze.

## STANDARD FEATURES

- 3 POINT HITCH, SIDE-SHIFT, CATEGORY 1 AND 2
- CAST IRON GEARBOX 540 RPM
- SIDE CHAIN ASA 80 RUNNING IN OIL BATH WITH AUTOMATIC TENSIONER
- ROTOR WITH 4 HOES PER FLANGE
- OPTION KIT 6 HOES PER FLANGE
- ADJUSTABLE SKIDS
- MANUAL SIDE SHIFT
- UNIVERSAL PTO SHAFT CATEGORY 4 - 700 MM

## CARACTÉRISTIQUES STANDARD

- ATTELAGE À 3 POINTS 1° ET 2° CATÉGORIE, DÉPORTABLE
- BOITIER EN FONTE 540 T/MIN
- TRANSMISSION PAR CHAÎNE ASA 80 A BAIN D'HUILE AVEC TENDEUR AUTOMATIQUE
- ROTOR AVEC 4 COUTEAUX PAR FLASQUE
- PRÉDISPOSITION KIT 6 COUTEAUX PAR FLASQUE
- PATINS RÉGLABLES
- DÉPLACEMENT LATÉRAL MANUEL
- CARDAN STANDARD 4° CATÉGORIE - 700 MM

## STANDARD EIGENSCHAFTEN

- DREIPUNKTBOCK-ANSCHLUß KATEGORIE 1 UND 2
- GUSSEISENES GETRIEBE 540 U/MIN
- KETTENANTRIEB ASA 80 IN ÖLBAD MIT AUTOMATISCHER KETTENSPELLER
- ROTOR MIT 4 MESSER PRO FLANSCH
- 6 MESSER PRO FLANSCH ALS ZUBEHÖR
- VERSTELLBARE KUFEN
- MECHANISCHER SEITENVERSCHIEBUNG
- STANDARD GELENKWELLE KATEGORIE 4 - 700 MM

## CARATTERISTICHE STANDARD

- ATTACCO A 3 PUNTI SPOSTABILE DI 1° E 2° CATEGORIA
- RIDUTTORE IN GHISA 540 G/MIN
- TRASMISSIONE A CATENA ASA 80 IN BAGNO D'OLIO CON TENDITORE AUTOMATICO
- ROTORE CON 4 ZAPPE PER FLANGIA
- PREDISPOSIZIONE KIT 6 ZAPPE PER FLANGIA
- SLITTE REGOLABILI
- SPOSTAMENTO LATERALE MANUALE
- CARDANO STANDARD 4° CATEGORIA - 700 MM

COD-MOD	hp								€
		cm	in	cm	in		kg	lbs	
<b>Holiday RS 85</b>	15 - 50	85	34"	105	42"	16	169	373	
<b>Holiday RS 105</b>	15 - 50	105	42"	125	50"	20	175	386	
<b>Holiday RS 125</b>	15 - 50	125	50"	145	58"	24	188	414	
<b>Holiday RS 145</b>	15 - 50	145	58"	165	66"	28	202	445	

Cod.	OPTIONAL	€
------	----------	---



**V**

Side shift by screw  
 Dispositif de déport par vis du troisième point  
 Spindelverschiebung vom PTO  
 Dispositivo di spostamento a vite dell'attacco a tre punti

Cod.	Type	€
------	------	---



**Z**

N° 6 hoes per flange  
 N. 6 couteaux par chaque flasque du rotor  
 Montage von 6 Messern auf jedem Rotorflansch  
 Montaggio di n° 6 zappe su ogni flangia del rotore

Holiday RS 85
Holiday RS 105
Holiday RS 125
Holiday RS 145

Cod.	€
------	---



**F**

Slip clutch PTO shaft  
 Dispositif de sécurité à boulon inclus dans le cardan  
 Kupplungssicherung im Kardan enthalten  
 Dispositivo di sicurezza a frizione incluso nel cardano

Cod.	€
------	---



**B**

Shear bolt PTO shaft  
 Dispositif de sécurité à friction inclus dans le cardan  
 Sicherheitsvorrichtung mit Bruchbolzen im Kardan enthalten  
 Dispositivo di sicurezza con bullone di rottura incluso nel cardano

**DIMENSIONS - DIMENSIONS - ABMESSUNGEN - INGOMBRI**

Type	A (cm)	B (cm)	C (cm)
Holiday RS 85	120	80	100
Holiday RS 105	125	80	100
Holiday RS 125	145	80	100
Holiday RS 145	165	80	100

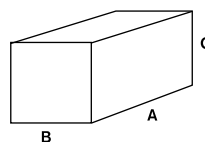

**PACKAGING - EMBALLAGE - VERPACKUNG - IMBALLAGGI**



- Single metal crate
- Caisse métallique unitaire
- Einzelne Metall Palette
- Cassa singola



# URT ED

Side shift rotary tiller

Fraise déportable

Seitenverschiebbare Bodenfräse

Zappatrice spostabile

HP

20 - 50

kW

15 - 40

rpm

540

 cm 18 - inch 7



ENG

This rotary tiller is suitable for heavy tilling in orchards and tree farms. The side-shift allows the tiller to till close to the trees. It is suitable for medium HP tractors.

FRA

Machine indiquée pour les travaux dans les vergers ou dans les cultures de petits arbres. Son déplacement latéral permet à l'opérateur de rapprocher la fraise aux cultures sans les endommager. Elle est indiquée pour les tracteurs de moyenne puissance.

DEU

Diese Bodenfräse ist für schwere Arbeiten im Obstbau und Baumschulen geeignet, dank seiner Seitenverschiebung wodurch ganz Nah bei den Bäumen gefräst werden kann. Es ist für Mittelstarken Traktoren geeignet.

ITA

Macchina indicata per lavorazioni gravose in frutteti o colture ad alberello, grazie allo spostamento laterale l'operatore può avvicinare la fresa alle colture senza danneggiarle. Adatta a trattori di medie potenze.

## STANDARD FEATURES

- 3 POINT HITCH, CATEGORY 1 AND 2, SIDE-SHIFT WITH SPINDLE
- CAST IRON GEARBOX 540 RPM
- CHAIN DRIVE ASA 80 IN OIL BATH WITH AUTOMATIC TENSIONER
- ROTOR WITH 4 HOES PER FLANGE
- OPTIONAL WITH 6 HOES PER FLANGE
- ADJUSTABLE SKIDS
- UNIVERSAL PTO SHAFT, CATEGORY 4 - 700 MM

## CARACTÉRISTIQUES STANDARD





- ATTELAGE À 3 POINTS, 1° ET 2° CATÉGORIE, DÉPORTABLE PAR VIS
- BOITIER EN FONTE 540 T/MIN
- TRANSMISSION À CHÂÎNE ASA 80 A BAIN D'HUILE AVEC TENDEUR AUTOMATIQUE
- ROTOR AVEC 4 COUTEAUX PAR FLASQUE
- PRÉDISPOSITION KIT 6 COUTEAUX PAR FLASQUE
- PATINS RÉGLABLES
- CARDAN STANDARD 4° CATÉGORIE - 700 MM

## STANDARD EIGENSCHAFTEN

- DREIPUNKTBOCK-ANSCHLUß KATEGORIE 1 UND 2 MIT SPINDELVERSCHIEBUNG
- GUSSEISENES GETRIEBE 540 U/MIN
- KETTENANTRIEB ASA 80 IN ÖLBAD MIT AUTOMATISCHER KETTENSANNER
- ROTOR MIT 4 MESSER PRO FLANSCH
- 6 MESSER PRO FLANSCH ALS ZUBEHÖR
- VERSTELLBARE KUFEN
- STANDARD GELENKWELLE KATEGORIE 4 - 700 MM

## CARATTERISTICHE STANDARD

- ATTACCO A 3 PUNTI DI 1° E 2° CATEGORIA, SPOSTABILE A VITE
- RIDUTTORE IN GHISA 540 G/MIN
- TRASMISSIONE A CATENA ASA 80 IN BAGNO D'OLIO CON TENDITORE AUTOMATICO
- ROTORE CON 4 ZAPPE PER FLANGIA
- PREDISPOSIZIONE KIT 6 ZAPPE PER FLANGIA
- SLITTE REGOLABILI
- CARDANO STANDARD 4° CATEGORIA - 700 MM

COD-MOD	hp								€
		cm	in	cm	in				
<b>URT ED 96</b>	20 - 50	<b>96</b>	38"	<b>110</b>	44"	<b>20</b>	<b>206</b>	454	
<b>URT ED 114</b>	20 - 50	<b>114</b>	46"	<b>130</b>	52"	<b>24</b>	<b>218</b>	481	
<b>URT ED 132</b>	20 - 50	<b>132</b>	52"	<b>145</b>	58"	<b>28</b>	<b>230</b>	507	
<b>URT ED 150</b>	20 - 50	<b>150</b>	60"	<b>165</b>	66"	<b>32</b>	<b>248</b>	547	
<b>URT ED 168</b>	20 - 50	<b>168</b>	67"	<b>185</b>	74"	<b>36</b>	<b>266</b>	586	

Cod.	OPTIONAL	Type	€
	<b>Z</b> N° 6 hoes per flange N. 6 couteaux par chaque flasque du rotor Montage von 6 Messer auf jedem Rotorflansch Montaggio di n° 6 zappe su ogni flangia del rotore	URT ED 96	
		URT ED 114	
		URT ED 132	
		URT ED 150	
		URT ED 168	

Cod.	OPTIONAL	Type	€
	<b>F</b> Slip clutch PTO shaft Dispositif de sécurité à friction inclus dans le cardan Kupplungssicherung im Kardan enthalten Dispositivo di sicurezza a frizione incluso nel cardano		

Cod.	OPTIONAL	Type	€
	<b>B</b> Shear bolt PTO shaft Dispositif de sécurité à boulon inclus dans le cardan Sicherheitsvorrichtung mit Bruchbolzen im Kardan enthalten Dispositivo di sicurezza con bullone di rottura incluso nel cardano		

**DIMENSIONS - DIMENSIONS - ABMESSUNGEN - INGOMBRI**

Type	A (cm)	B (cm)	C (cm)
URT ED 96	120	80	100
URT ED 114	130	80	100
URT ED 132	150	80	100
URT ED 150	170	80	100
URT ED 168	180	80	100

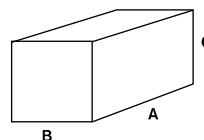

**PACKAGING - EMBALLAGE - VERPACKUNG - IMBALLAGGI**



- Single metal crate
- Caisse métallique unitaire
- Einzelne Metall Palette
- Cassa singola





**Stone buriers & rotary harrows**  
**Enfouisseuses & herses rotatives**  
**Bodenumkehrfräse & Kreiseleggen**  
**Interrasassi & erpici rotanti**



## Yellowstone

20 - 50 HP

96 / 114 / 132 /  
150 / 168

42 43



## Rotex L

12 - 25 HP

88 / 104 / 120 /  
136

44 45



## Rotex M

15 - 45 HP

90 / 110 / 130 / 150

46 47



## Rotex H

40 - 100 HP

170 / 190 / 230 / 250

48 49

**Seeders**  
**Semoirs**  
**Sämaschinen**  
**Seminatrici**



## Grass

90 / 100 / 120 / 140

50 51



## Professional

11 / 13 / 15

52 53



# Yellowstone

**Stone burier**  
**Enfouisseuse**  
**Bodenumkehrfräse**  
**Interrasassi**

**HP**  
**20 - 50**

**kW**  
**15 - 40**

**rpm**  
**540**

 **cm 18 - inch 7**

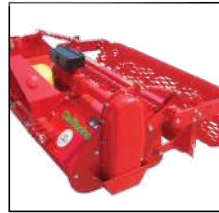

**ENG**

A universal stone burier, suitable for any terrain with stones from 1 to 4 inches in diameter. It prepares the terrain for seeding and can be equipped with a seeder for one-pass operation.

**FRA**

Machine universelle utilisées sur des terrains souples et argileux, et aussi à la présence des cailloux qui varient de 2 à 10 cm de diamètre, afin de préparer le terrain à la semence.

**DEU**

Eine universal Umkehrfräse die bei jedem Boden, Steine von 2-10 cm Durchmesser eingräbt. Es bereitet der Boden vor und kann mit eine Sämaschine ausgestattet werden um alles in ein Durchgang zu erledigen.

**ITA**

Macchina universale, utilizzata sia su terreni sciolti che argillosi, con presenza di ciottoli di dimensioni che possono variare da 2 a 10 cm di diametro con la funzione di preparare il terreno per essere seminato.

## STANDARD FEATURES

- 3 POINT HITCH, CATEGORY 1 AND 2
- CAST IRON GEARBOX 540 RPM
- CHAIN DRIVE ASA 80 IN OIL BATH WITH AUTOMATIC TENSIONER
- ROTOR WITH 6 HOES PER FLANGE
- ADJUSTABLE SCREEN ROLLER
- ADJUSTABLE LEVELLING BLADE
- RAKE WITH SPRING TINES IN HARMONIC STEEL
- PTO SHAFT, CATEGORY 4 WITH SLIP CLUTCH - 700 MM

## CARACTÉRISTIQUES STANDARD





- ATELAGE À 3 POINTS DE 1° ET 2° CATÉGORIE
- BOITIER EN FONTE 540 T/MIN
- TRANSMISSION PAR CHAÎNE A BAIN D'HUILE ASA 80 AVEC TENDEUR AUTOMATIQUE
- ROTOR AVEC 6 COUTEAUX PAR FLASQUE
- ROULEAU GRILLE RÉGLABLE.
- LAME NIVELEUSE RÉGLABLE.
- GRILLE DE SÉPARATION COMPOSÉE DE DENTS À RESSORT EN ACIER HARMONIQUE
- CARDAN, 4° CATÉGORIE AVEC FRICTION DE SÉCURITÉ - 700 MM

## STANDARD EIGENSCHAFTEN

- DREIPUNKTBOCK-ANSCHLUß KATEGORIE 1 UND 2
- GUSSEISENEN GETRIEBE 540 U/MIN
- KETTENANTRIEB ASA 80 IN ÖLBAD MIT AUTOMATISCHER KETTENSPELLER
- ROTOR MIT 6 MESSER PRO FLANSCH
- VERSTELLBARE GITTERWALZE
- VERSTELLBARES PLANIERSCHILD
- TRENNGITTER AUS FEDERZÄHNE AUS STAHL
- GELENKWELLE KATEGORIE 4 MIT RUTSCHKUPPLUNG - 700 MM

## CARATTERISTICHE STANDARD

- ATTACCO A 3 PUNTI DI 1° E 2° CATEGORIA
- RIDUTTORE IN GHISA 540 G/MIN.
- TRASMISSIONE A CATENA IN BAGNO D'OLIO ASA 80 CON TENDITORE AUTOMATICO
- ROTORE CON 6 ZAPPE PER FLANGIA
- RULLO A GRIGLIA REGOLABILE
- LAMA LIVELLATRICE REGOLABILE
- GRIGLIA DI SEPARAZIONE COMPOSTA DA DENTI A MOLLA IN ACCIAIO ARMONICO
- CARDANO 4° CATEGORIA SICUREZZA FRIZIONE - 700 MM

COD-MOD	hp								€
		cm	in	cm	in				
<b>Yellowstone 96</b>	20 - 50	<b>96</b>	38"	<b>115</b>	46"	<b>30</b>	<b>334</b>	736	
<b>Yellowstone 114</b>	20 - 50	<b>114</b>	46"	<b>135</b>	54"	<b>36</b>	<b>366</b>	807	
<b>Yellowstone 132</b>	20 - 50	<b>132</b>	52"	<b>155</b>	62"	<b>42</b>	<b>394</b>	869	
<b>Yellowstone 150</b>	20 - 50	<b>150</b>	60"	<b>175</b>	70"	<b>48</b>	<b>424</b>	935	
<b>Yellowstone 168</b>	20 - 50	<b>168</b>	67"	<b>195</b>	78"	<b>54</b>	<b>442</b>	974	

	Cod.	OPTIONAL	Type	Kg	€
	<b>P11</b>		Yellowstone 96	100	
	<b>P11</b>	"Professional" seeder	Yellowstone114	100	
	<b>P13</b>	"Professional" semoir	Yellowstone132	110	
	<b>P13</b>	"Professional" Sämaschine	Yellowstone150	110	
	<b>P15</b>	"Professional" seminatrice	Yellowstone168	125	

	Cod.		Type	Kg	€
	<b>G90</b>	"Grass" seeder	Yellowstone 96	60	
	<b>G100</b>	"Grass" semoir	Yellowstone 114	64	
	<b>G140</b>	"Grass" Sämaschine	Yellowstone 132	70	
	<b>G140</b>	"Grass" seminatrice			

	Cod.				
	<b>B</b>	Shear bolt PTO shaft			
		Dispositif de sécurité à friction inclus dans le cardan			
		Sicherheitsvorrichtung mit Bruchbolzen im Kardan enthalten			
		Dispositivo di sicurezza con bullone di rottura incluso nel cardano			

**DIMENSIONS - DIMENSIONS - ABMESSUNGEN - INGOMBRI**

Type	A (cm)	B (cm)	C (cm)
Yellowstone 96	160	120	100
Yellowstone 114	160	140	100
Yellowstone 132	160	160	100
Yellowstone 150	180	160	100
Yellowstone 168	200	160	100

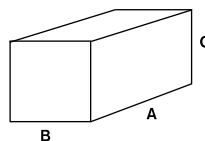



# Rotex L

Rotary harrow  
Herse rotative  
Kreiselegge  
Erpice rotante

HP  
15 - 25

kW

10 - 20

rpm

540

 cm 16 - inch 6

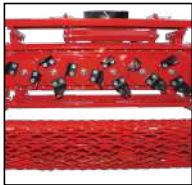

ENG

This light rotary harrow is ideal for special crops in soft terrain outside or in greenhouses. It tills the ground gently and allows excellent water drainage.

FRA

Herse rotative indiquée pour des cultures spécialisées dans un terrain friable sous la serre ou dans un terrain labouré. Il permet un travail souple pour un parfait drainage d'eau.

DEU

Diese leichte Kreiselegge findet Verwendung in leichten Boden und auch in Gewächshäusern. Es sorgt für eine sanfte Bodenbearbeitung und fordert die Entwässerung.

ITA

Erpice rotante impiegato su terreni sciolti per colture specializzate anche sotto serra. Consente una lavorazione soffice del terreno che favorisce il perfetto drenaggio dell'acqua.

## STANDARD FEATURES

- 3 POINT HITCH, CATEGORY 1
- CAST IRON GEARBOX 540 RPM
- GEAR DRIVEN (IN OIL BATH)
- TWO SHAPED BLADES PER ROTOR
- SELF-ADJUSTING SIDE PROTECTION
- MOUNTING POINTS FOR ROLLER
- MOUNTING POINTS FOR LEVELLING BLADE
- MOUNTING POINTS FOR SEEDER
- PTO SHAFT, CATEGORY 2, WITH SHEAR BOLT - 700 MM
- SPECIAL STEEL BLADES TO REDUCE WEAR

## CARACTÉRISTIQUES STANDARD

- ATTELAGE À 3 POINTS 1<sup>o</sup> CATÉGORIE
- BOITIER EN FONTE 540 T/MIN
- TRANSMISSION À ENGRENAGES A BAIN D'HUILE
- ROTORS À 2 DENTS RÉVERSIBLES
- PROTECTIONS LATÉRALES AUTORÉGULANTS
- PRÉDISPOSÉE POUR MONTAGE KIT ROULEAU
- PRÉDISPOSÉE POUR MONTAGE KIT LAME NIVELEUSE
- PRÉDISPOSÉE POUR MONTAGE SEMOIR
- CARDAN 2<sup>o</sup> CATÉGORIE AVEC BOULON DE SÉCURITÉ - 700 MM
- DENTS HAUTE RESISTANCE

## STANDARD EIGENSCHAFTEN

- DREIPUNKTBOCK-ANSCHLUß KATEGORIE 1
- GUSSEISENES GETRIEBE 540 U/MIN
- ZAHNRADANTRIEB IN ÖLBAD
- ZWEI MESSERZINKEN PER ROTOR
- SELBSTREGULIERENDER SEITENSCHUTZ
- VORBEREITET FÜR EINE WALZE
- VORBEREITET FÜR EIN PLANIERSCHILD (VORNE ODER HINTEN)
- VORBEREITET FÜR EINE SÄMASCHINE
- STANDARD GELENKWELLE KATEGORIE 2 MIT SCHERBOLZEN - 700 MM
- MESSERZINKEN AUS HOHEN WIDERSTAND

## CARATTERISTICHE STANDARD

- ATTACCO A 3 PUNTI DI 1<sup>o</sup> CATEGORIA
- RIDUTTORE IN GHISA 540 G/MIN.
- TRASMISSIONE AD INGRANAGGI IN BAGNO D'OLIO
- ROTORI CON 2 DENTI
- PROTEZIONI LATERALI AUTOREGOLANTI
- PREDISPOSTO PER MONTAGGIO KIT RULLO
- PREDISPOSTO PER MONTAGGIO KIT LAMA LIVELLATRICE
- PREDISPOSIZIONE PER MONTAGGIO SEMINATRICE
- CARDANO 2<sup>o</sup> CATEGORIA SICUREZZA BULLONE - 700 MM
- DENTI AD ALTA RESISTENZA

COD-MOD	hp								€
		cm	in	cm	in				
<b>Rotex L 88</b>	12 - 25	88	35"	100	40"	10	145	320	
<b>Rotex L 104</b>	12 - 25	104	41"	115	46"	12	161	355	
<b>Rotex L 120</b>	12 - 25	120	48"	130	52"	14	176	388	
<b>Rotex L 136</b>	12 - 25	136	54"	145	58"	16	187	412	

	Cod.	OPTIONAL	Type	Kg	€
	<b>G90</b>			Rotex L 88	60
<b>G100</b>		"Grass" seeder "Grass" semoir	Rotex L 104	64	
<b>G120</b>		"Grass" Sämaschine "Grass" seminatrice	Rotex L 120	70	
<b>G140</b>			Rotex L 136	78	

	Cod.	OPTIONAL	Type	Kg	€
	<b>GA</b>		Cage roller Rouleau cage avec tuyaux Walze aus Rohren Rullo con tubi	Rotex L 88	38
			Rotex L 104	40	
			Rotex L 120	42	
			Rotex L 136	44	

	Cod.	OPTIONAL	Type	Kg	€
	<b>GR</b>		Wire roller Rouleau avec tôle grillée Walze aus Gitterblech Rullo con lamiera grigliata	Rotex L 88	38
			Rotex L 104	40	
			Rotex L 120	42	
			Rotex L 136	44	

	Cod.	OPTIONAL	Type	Kg	€
	<b>LL</b>		Soil levelling blade Lame niveluse du terrain Planierschild für den Boden Lama di livellamento del terreno	Rotex L 88	21
			Rotex L 104	22	
			Rotex L 120	23	
			Rotex L 136	24	

**DIMENSIONS - DIMENSIONS - ABMESSUNGEN - INGOMBRI**

Type	A (cm)	B (cm)	C (cm)
Rotex L 88	120	80	95
Rotex L 104	135	80	95
Rotex L 120	150	80	95
Rotex L 136	170	80	95

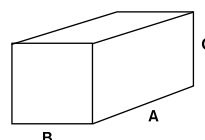

**PACKAGING - EMBALLAGE - VERPACKUNG - IMBALLAGGI**



- Single metal crate
- Caisse Métallique unitaire
- Einzelne Metall Palette
- Cassa singola



# Rotex M

Rotary harrow  
Herse rotative  
Kreiselegge  
Erpice rotante

## HP

## 15 - 45

kW

12 - 35

rpm

540

 cm 19 - inch 8



ENG

This medium duty rotary harrow is ideal for special crops in soft terrain outside or in greenhouses. It tills the ground gently and allows excellent water drainage.

FRA

Herse rotative indiquée pour des cultures spécialisées dans un terrain friable, sous la serre ou dans un terrain labouré. Il permet un travail souple pour un parfait drainage d'eau.

DEU

Diese mittlere Kreiselegge findet Verwendung in leichten Boden und auch in Gewächshäusern. Es sorgt für eine sanfte Bodenbearbeitung und fordert die Entwässerung.

ITA

Erpice rotante impiegato su terreni sciolti per colture specializzate, sotto serra o in campo aperto. Consente una lavorazione soffice del terreno che favorisce il perfetto drenaggio dell'acqua.

### STANDARD FEATURES

- 3 POINT HITCH, CATEGORY 1
- CAST IRON GEARBOX 540 RPM
- GEAR DRIVEN IN OIL BATH
- TWO SHAPED BLADES PER ROTOR
- SELF-ADJUSTING SIDE PROTECTION
- MOUNTING POINTS FOR ROLLER
- MOUNTING POINTS FOR LEVELLING BLADE
- MOUNTING POINTS FOR SEEDER
- UNIVERSAL PTO SHAFT, CATEGORY 4, WITH SHEAR BOLT - 700 MM

### CARACTÉRISTIQUES STANDARD





- ATTELAGE À 3 POINTS CATÉGORIE 1
- BOITIER EN FONTE 540 T/MIN
- TRANSMISSION À ENGRENAGES A BAIN D'HUILE
- ROTORS AVEC 2 DENTS
- PROTECTIONS LATÉRALES AUTORÉGULANTES
- PRÉDISPOSÉE POUR MONTAGE KIT ROULEAU
- PRÉDISPOSÉE POUR MONTAGE KIT LAME NIVELEUSE
- PRÉDISPOSÉE POUR MONTAGE SEMOIR
- CARDAN STANDARD 4° CATÉGORIE AVEC BOULON DE SÉCURITÉ - 700 MM

### STANDARD EIGENSCHAFTEN

- DREIPUNKTBOCK-ANSCHLUß KATEGORIE 1
- GUSSEISENENES GETRIEBE 540 U/MIN
- ZAHNRADANTRIEB IN ÖLBAD
- ZWEI MESSERZINKEN PER ROTOR
- DREHZAHL MESSERZINKEN 370 U/MIN
- SELBSTREGULIERENDER SEITENSCHUTZ
- VORBEREITET FÜR EINE WALZE
- VORBEREITET FÜR EIN PLANIERSCHILD (VORNE ODER HINTEN)
- VORBEREITET FÜR SÄMASCHINE
- STANDARD GELENKWELLE KATEGORIE 4 MIT SCHERBOLZEN - 700 MM

### CARATTERISTICHE STANDARD

- ATTACCO A 3 PUNTI DI 1° CATEGORIA
- RIDUTTORE IN GHISA 540 G/MIN.
- TRASMISSIONE AD INGRANAGGI IN BAGNO D'OLIO
- ROTORI CON 2 DENTI
- PROTEZIONI LATERALI AUTOREGOLANTI
- PREDISPOSTO PER MONTAGGIO KIT RULLO
- PREDISPOSTO PER MONTAGGIO KIT LAMA LIVELLATRICE
- PREDISPOSTO PER MONTAGGIO SEMINATRICE
- CARDANO STANDARD 4° CATEGORIA CON BULLONE DI SICUREZZA - 700 MM

COD-MOD	hp								€
		cm	in	cm	in				
<b>Rotex M 90</b>	15 - 45	90	36"	100	40"	8	175	386	
<b>Rotex M 110</b>	15 - 45	110	44"	120	48"	10	214	472	
<b>Rotex M 130</b>	15 - 45	130	52"	140	56"	12	239	527	
<b>Rotex M 150</b>	15 - 45	150	60"	160	64"	14	263	580	

	Cod.	OPTIONAL	Type	Kg	€
	<b>G90</b>		"Grass" seeder	Rotex M 90	60
<b>G100</b>		"Grass" semoir	Rotex M 110	64	
<b>G120</b>		"Grass" Sämaschine "Grass" seminatrice	Rotex M 130	70	

	Cod.	OPTIONAL	Type	Kg	€
	<b>P11</b>		"Professional" seeder	Rotex M 110	100
<b>P13</b>		"Professional" semoir	Rotex M 130	110	
<b>P13</b>		"Professional" Sämaschine "Professional" seminatrice	Rotex M 150	110	

	Cod.	OPTIONAL	Type	Kg	€
	<b>GA</b>		Cage roller Rouleau cage avec tuyaux Walze aus Rohren Rullo con tubi	Rotex M 90	38
			Rotex M 110	42	
			Rotex M 130	46	
			Rotex M 150	50	

	Cod.	OPTIONAL	Type	Kg	€
	<b>GR</b>		Wire roller Rouleau avec tôle grillée Walze aus Gitterblech Rullo con lamiera grigliata	Rotex M 90	38
			Rotex M 110	42	
			Rotex M 130	46	
			Rotex M 150	50	

	Cod.	OPTIONAL	Type	Kg	€
	<b>LL</b>		Soil levelling blade Lame niveluse du terrain Planierschild für den Boden Lama di livellamento del terreno	Rotex M 90	20
			Rotex M 110	22	
			Rotex M 130	23	
			Rotex M 150	24	

**DIMENSIONS - DIMENSIONS - ABMESSUNGEN - INGOMBRI**

Type	A (cm)	B (cm)	C (cm)
Rotex M 90	120	80	95
Rotex M 110	140	80	95
Rotex M 130	160	80	95
Rotex M 150	180	80	95

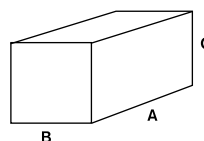

**PACKAGING - EMBALLAGE - VERPACKUNG - IMBALLAGGI**



- Single metal crate
- Caisse Métallique unitaire
- Einzelne Metall Palette
- Cassa singola



# Rotex H

**Rotary harrow**  
**Herse rotative**  
**Kreiselegge**  
**Erpice rotante**

**HP**  
**40 - 100**

**kW**

**22 - 60**

**rpm**

**540**

 **cm 21 - inch 8**

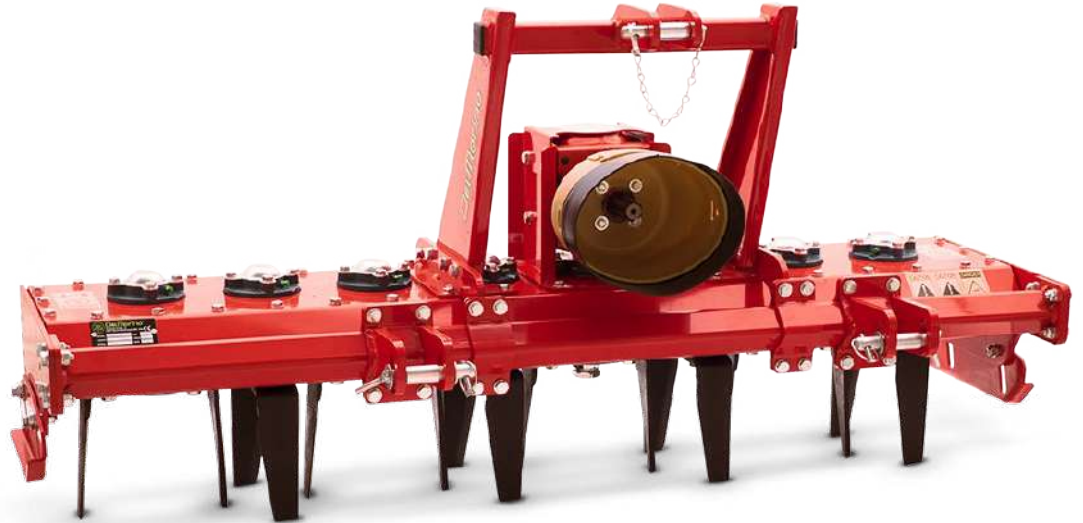

**ENG**

This heavy duty rotary harrow is ideal for special crops in hard or soft terrain. It tills the ground gently and allows excellent water drainage. It has a reinforced frame for durability and reliability.

**FRA**

Herse rotative professionnelle indiquée pour un terrain compact dans les cultures spécialisées ou dans un terrain labouré. Elle permet un travail souple du terrain. Son châssis renforcé permet à la machine de supporter des lourdes sollicitudes sans en compromettre la stabilité.

**DEU**

Diese schwere Kreiselegge findet Verwendung in harten sowie leichten Boden. Es sorgt für eine sanfte Bodenbearbeitung und fordert die Entwässerung. Sein verstärkter Rahmen sorgt für Haltbarkeit und Zuverlässigkeit.

**ITA**

Erpice rotante professionale impiegato su terreni sciolti anche duri e tenaci per colture specializzate, o in campo aperto. Consente una lavorazione soffice del terreno. Telaio rinforzato in grado di sopportare sollecitazioni gravose senza comprometterne la stabilità.

## STANDARD FEATURES

- 3 POINT HITCH, CATEGORY 2
- CAST IRON GEARBOX 540 RPM
- GEAR DRIVEN IN OIL BATH
- TWO SHAPED BLADES PER ROTOR
- SELF-ADJUSTING SIDE PROTECTION
- MOUNTING POINTS FOR ROLLER
- MOUNTING POINTS FOR LEVELLING BLADE AND SEEDER
- SHEAR BOLT PTO SHAFT CATEGORY 5 (170 - 190), ROTEX CATEGORY 6 (230 - 250) - 700 MM
- REINFORCED FRONT BAR

## CARACTÉRISTIQUES STANDARD





- ATTELAGE À 3 POINTS 2<sup>e</sup> CATÉGORIE
- BOITIER EN FONTE 540 T/MIN
- TRANSMISSION À ENGRENAGES À BAIN D'HUILE
- ROTORS AVEC 2 DENTS
- PROTECTIONS LATÉRALES AUTORÉGULANTES
- PRÉDISPOSÉE POUR MONTAGE KIT ROULEAU
- PRÉDISPOSÉE POUR MONTAGE KIT LAME NIVELEUSE ET SEMOIR
- CARDAN BOULON 5<sup>e</sup> CATÉGORIE (170 - 190) OU ROTEX 6<sup>e</sup> CATÉGORIE (230 - 250) - 700 MM
- BARRE FRONTALE DE RENFORCEMENT

## STANDARD EIGENSCHAFTEN

- DREIPUNKTBOCK-ANSCHLUß KATEGORIE 2
- GUSSEISENES GETRIEBE 540 U/MIN
- ZAHNRADANTRIEB IN ÖLBAD
- ZWEI MESSERZINKEN PER ROTOR
- SELBSTREGULIERENDER SEITENSCHUTZ
- VORBEREITET FÜR EIN WALZE
- VORBEREITET FÜR EINE PLANIERSCHILD (VORNE ODER HINTEN)
- VORBEREITET FÜR EINE SÄMASCHINE
- GELENKWELLE KATEGORIE 5 (170 - 190) KATEGORIE 6 (230 - 250) MIT SCHERBOLZEN - 700 MM
- VORDERROHR ALS VERSTÄRKUNG (60 X 60 MM AUS 6 MM STAHL)

## CARATTERISTICHE STANDARD

- ATTACCO A 3 PUNTI DI 2<sup>a</sup> CATEGORIA
- RIDUTTORE IN GHISA 540 G/MIN.
- TRASMISSIONE AD INGRANAGGI IN BAGNO D'OLIO
- ROTORI CON 2 DENTI
- PROTEZIONI LATERALI AUTOREGOLANTI
- PREDISPOSTO PER MONTAGGIO KIT RULLO
- PREDISPOSTO PER MONTAGGIO KIT LAMA LIVELLATRICE E SEMINATRICE
- CARDANO BULLONE 5<sup>a</sup> CATEGORIA (170 - 190) E ROTEX 6<sup>a</sup> CATEGORIA (230 - 250) CON SICUREZZA BULLONE - 700 MM
- BARRA FRONTALE DI RINFORZO

COD-MOD	hp								€
		cm	in	cm	in				
<b>Rotex H 170</b>	<b>40 - 100</b>	<b>170</b>	<b>67"</b>	<b>180</b>	<b>72"</b>	<b>16</b>	<b>319</b>	<b>703</b>	
<b>Rotex H 190</b>	<b>40 - 100</b>	<b>190</b>	<b>75"</b>	<b>200</b>	<b>80"</b>	<b>18</b>	<b>345</b>	<b>761</b>	
<b>Rotex H 230</b>	<b>40 - 100</b>	<b>230</b>	<b>90"</b>	<b>240</b>	<b>96"</b>	<b>22</b>	<b>519</b>	<b>1144</b>	
<b>Rotex H 250</b>	<b>40 - 100</b>	<b>250</b>	<b>100"</b>	<b>260</b>	<b>104"</b>	<b>24</b>	<b>551</b>	<b>1215</b>	

Cod.	OPTIONAL	Type	Kg	€
 <b>P15</b>	"Professional" seeder "Professional" semoir "Professional" Sämaschine "Professional" seminatrice	Rotex H 170	125	
		Rotex H 190	125	
		Rotex H 230	125	
		Rotex H 250	125	

Cod.	OPTIONAL	Type	Kg	€
 <b>GA</b>	Cage roller Rouleau cage avec tuyaux Walze aus Rohren Rullo con tubi	Rotex H 170	62	
		Rotex H 190	64	
		Rotex H 230	68	
		Rotex H 250	73	

Cod.	OPTIONAL	Type	Kg	€
 <b>GR</b>	Wire roller Rouleau avec tôle grillée Walze aus Gitterblech Rullo con lamiera grigliata	Rotex H 170	100	
		Rotex H 190	111	
		Rotex H 230	126	
		Rotex H 250	141	

Cod.	OPTIONAL	Type	Kg	€
 <b>LL</b>	Soil levelling blade Lame niveluse du terrain Planierschild für den Boden Lama di livellamento del terreno	Rotex H 170	22	
		Rotex H 190	24	
		Rotex H 230	26	
		Rotex H 250	29	

**DIMENSIONS - DIMENSIONS - ABMESSUNGEN - INGOMBRI**

Type	A (cm)	B (cm)	C (cm)
Rotex H 170	<b>200</b>	<b>80</b>	<b>95</b>
Rotex H 190	<b>220</b>	<b>80</b>	<b>95</b>
Rotex H 230	<b>260</b>	<b>80</b>	<b>95</b>
Rotex H 250	<b>280</b>	<b>80</b>	<b>95</b>

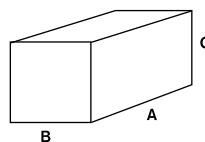

**PACKAGING - EMBALLAGE - VERPACKUNG - IMBALLAGGI**



- Single metal crate
- Caisse Métallique unitaire
- Einzelne Metall Palette
- Cassa singola



# Grass

Seeder for grass  
Semoir pour herbe  
Sämaschine für Gras  
Seminatrice per erba

**YELLOWSTONE**  
**ROTEX L**  
**ROTEX M**



**ENG**

The GRASS seeder is ideal for distributing small seeds for cover crops, pastures and meadows. The seed flow regulation can be regulated remotely by the operator.

**FRA**

Le semoir GRASS distribue uniformément sur le terrain tous les semences de petites dimensions pour jardins, pâturages, et prés. Equipé d'un mécanisme qui permet de régler le flux des graines directement du tracteur.

**DEU**

Die Sämaschine GRASS ist ideal um Grasartigesamen für Felder, Wiesen oder andere Gebiete zu säen. Die Saatmenge kann durch den Fahrer vom Traktor aus geregelt werden.

**ITA**

Seminatrice in grado di distribuire uniformemente semi di piccole dimensioni per prati, pascoli, impianti erbosi. La regolazione del flusso del seme può essere effettuata stando seduti sul trattore.

## STANDARD FEATURES

- ADJUSTABLE FLOW RATE
- CHAIN DRIVE VIA MACHINE REAR ROLLER
- MOUNTING KIT INCLUDED
- FITS ON ROTARY HARROW ROTEX L & M AND YELLOWSTONE STONEBURIER

## CARACTÉRISTIQUES STANDARD

- DISPOSITIF REGLABLE D'OUVERTURE POUR L'ÉPANDAGE DES GRAINES
- TRANSMISSION PAR CHAÎNE RELIÉE AU ROULEAU ARRIÈRE DE L'HERSE ROTATIVE
- KIT POUR L'ATTACHEMENT INCLUS
- LE SEMOIR PEUT ÊTRE MONTÉ SUR LES MACHINES SUIVANTES: YELLOWSTONE, ROTEX M E ROTEX L

## STANDARD EIGENSCHAFTEN

- EINSTELLBARE VERTEILERÖFFNUNGEN
- KETTENANTRIEB ÜBER WALZE DER KREISELEGGE
- KIT MASCHINEN ANSCHLUSS ENTHALTEN
- PASST ZUR KREISELEGGEN ROTEX L & M UND UMKEHRFRÄSE YELLOWSTONE

## CARATTERISTICHE STANDARD

- REGOLATORE DI APERTURA CANALI DI SPARGIMENTO DEL SEME
- TRASMISSIONE A CATENA COLLEGATA AL RULLO POSTERIORE DELLA MACCHINA
- KIT PER ATTACCO ALLA MACCHINA INCLUSO
- APPLICABILE A YELLOWSTONE, ROTEX M E ROTEX L

COD-MOD	Yellowstone	Rotex L	Rotex M	Capacity	kg	lbs	€
<b>Grass 90</b>	<b>96</b>	<b>88</b>	<b>90</b>	<b>54</b>	<b>60</b>	<b>132</b>	
<b>Grass 100</b>	<b>114</b>	<b>104</b>	<b>110</b>	<b>65</b>	<b>64</b>	<b>141</b>	
<b>Grass 120</b>	-	<b>120</b>	<b>130</b>	<b>76</b>	<b>70</b>	<b>154</b>	
<b>Grass 140</b>	<b>132</b>	<b>136</b>	-	<b>87</b>	<b>78</b>	<b>172</b>	

At the moment of the order specify the model of the machine to fit the seeder.

Au moment de la commande spécifier le modèle de la machine sur laquelle sera monté le semoir.

Bei Bestellung bitte das Modell der Maschine an dem die Sämaschine angebaut werden soll angeben.

Al momento dell'ordine specificare il modello della macchina alla quale applicare la seminatrice.

**DIMENSIONS - DIMENSIONS - ABMESSUNGEN - INGOMBRI**

Type	A (cm)	B (cm)	C (cm)
Grass 90	110	40	40
Grass 110	125	40	40
Grass 120	140	40	40
Grass 140	155	40	40

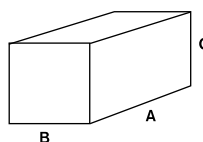



# Professional

**Multipurpose seeder**  
**Semoir polyvalente**  
**Mehrzweck Sämaschine**  
**Seminatrice polyvalente**

**YELLOWSTONE**  
**ROTEX M**  
**ROTEX H**

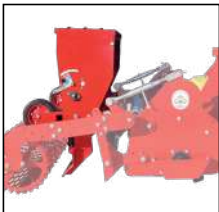

**ENG**

The PROFESSIONAL seeder offers a precise and uniform distribution of seeds. It has bronze seed cups and can be used with both small and large seeds. It can be used for seeding cover crops, wheat, corn, etc.

**FRA**

Le semoir PROFESSIONAL distribue uniformément sur le terrain toutes les semences de petites et grandes dimensions en étant équipé de distributeurs spéciaux en laiton. Le semoir est conseillé pour les prés, les pâturages et les cultures sur terrain labouré, et aussi pour maïs, blé etc.

**DEU**

Die PROFESSIONAL Sämaschine bietet eine genaue und gleichmäßige Verteilung der Samen. Es hat Messingsamenverteiler und kann sowohl kleine als auch grosse Samen säen. Es kann für Weizen, Korn und Getreide usw eingesetzt werden.

**ITA**

La Seminatrice PROFESSIONAL è in grado di distribuire uniformemente semi di piccole e grandi dimensioni essendo dotata di distributori in ottone. Utilizzo consigliato per prati, pascoli, coltivazioni in campo aperto, per grano, mais, ecc.

## STANDARD FEATURES

- ADJUSTABLE FLOW RATE
- INDIVIDUAL SLUICE GATES
- FAST EMPTYING
- MULTI DISPENSER
- CHAIN DRIVE
- MOUNTING KIT INCLUDED FOR ROTEX AND YELLOWSTONE
- BRASS SEED CUPS
- FITS ON ROTARY HARROW ROTEX M & H AND STONEBURIER YELLOWSTONE
- SUITABLE TO: WHEAT - CORN - PEAS - HEMP - SORGE - ALFALFA - ONION

## CARACTÉRISTIQUES STANDARD

- DÉBIT RÉGLABLE
- VANNES INDIVIDUELLES
- VIDANGE RAPIDE
- ALIMENTATION PAR ROULEAU DOSEUR
- TRANSMISSION PAR CHAÎNE
- KIT DE MONTAGE INCLUS POUR ROTEX ET YELLOWSTONE
- DISTRIBUTEUR DE SELECTION DES GRAINES EN CUIVRE JAUNE
- IL PEUT ETRE APPLIQUÉ À L'HERSE ROTATIVE ROTEX M & H ET ENFOUISSEUSE YELLOWSTONE
- ADAPTÉ POUR: BLÉ - CÉRÉALES - POIS - CHANVRE - SORGHO - LUZERNE - OIGNONS

## STANDARD EIGENSCHAFTEN

- EINSTELLBARE DURCHFLUSSMENGE
- EINZELNE SCHLEUSEN
- SCHNELLE ENTLERUNG
- MEHRFACH VERTEILER
- KETTENANTRIEB
- PROFESSIONELLE SÄMASCHINE FÜR UMKEHRFRÄSEN YELLOWSTONE UND KREISELEGGEN ROTEX
- SAMEN VERTEILER IN MESSING
- PASST ZUR KREISELEGGEN ROTEX M & H UND UMKEHRFRÄSE YELLOWSTONE
- GEEIGNET FÜR: WEIZEN - KORN - GETREIDE - ERBSEN - HANF - MOHRENHIRSE - LUZERNE - ZWIEBELN

## CARATTERISTICHE STANDARD

- PORTATA REGOLABILE
- PARATOIE INDIVIDUALI
- SVUOTAMENTO RAPIDO
- MULTIDOSATORE
- TRASMISSIONE A CATENA
- KIT DI MONTAGGIO INCLUSO PER ROTEX E YELLOWSTONE
- DISTRIBUTORE DI SELEZIONE DEL SEME IN OTTONE
- APPLICABILE AD ERPICI ROTANTI ROTEX M & H E ZAPPATRICE INTERRASASSI YELLOWSTONE
- ADATTA PER: FRUMENTO - CEREALI - PISELLI - CANAPA - SORGO - ERBA MEDICA - CIPOLLA

COD-MOD	Yellowstone	Rotex M	Rotex H	Capacity	kg	lbs	€
<b>P 11</b>	<b>96 - 114</b>	<b>110</b>	<b>-</b>	<b>100</b>	<b>100</b>	<i>220</i>	
<b>P 13</b>	<b>132 - 150</b>	<b>130 - 150</b>	<b>-</b>	<b>135</b>	<b>110</b>	<i>243</i>	
<b>P 15</b>	<b>168</b>	<b>-</b>	<b>170 - 250</b>	<b>160</b>	<b>125</b>	<i>276</i>	

At the moment of the order specify the model of the machine to fit the seeder.

Au moment de la commande spécifier le modèle de la machine sur laquelle sera monté le semoir.

Bei Bestellung bitte das Modell der Maschine an dem die Sämaschine angebaut werden soll angeben.

Al momento dell'ordine specificare il modello della macchina alla quale applicare la seminatrice.

**DIMENSIONS - DIMENSIONS - ABMESSUNGEN - INGOMBRI**

Type	A (cm)	B (cm)	C (cm)
Professional 11	<b>105</b>	<b>40</b>	<b>55</b>
Professional 13	<b>140</b>	<b>40</b>	<b>55</b>
Professional 15	<b>160</b>	<b>40</b>	<b>55</b>

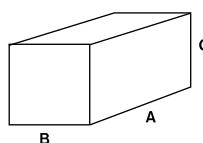



Del Morino

Del Morino

Del Morino

Del Morino

Levante 250

M

CAUTION CAUTION DANGER

## Mulchers Broyeurs Mulchgeräte Trinciatrici



### Ginger

12 - 30 HP

80 / 96 / 106 / 125 /  
145

58 59



### Funny

12 - 30 HP

80 / 93 / 106 /  
132 / 158

60 61



### Funny Top

12 - 30 HP

80 / 93 / 106 / 132  
158

62 63



### Disco

12 - 40 HP

96 / 115 / 125 / 145  
165

64 65



### Disco Top

12 - 40 HP

96 / 115 / 125 / 145  
165

66 67



### Centurion

15 - 50 HP

106 / 132 / 158 /  
186

68 69



### Flipper

15 - 70 HP

80 / 106 / 132 /  
158 / 186 / 214

70 71



### Farm

50 - 80 HP

158 / 186 / 214

72 73



### Levante

50 - 120 HP

140 / 160 / 190 /  
220 / 250

74 75



### Levante Plus

80 - 120 HP

250 / 270

76 77



### Victor

50 - 120 HP

150 / 170 / 190 /  
210 / 230 / 250 / 270

78 79



### DMK

15-80 HP

90 / 100 / 110 / 120 /  
135 / 150 / 150/3 /  
180/3

80 81



**Direction of rotation**  
**Sens de rotation**  
**Drehrichtung**  
**Senso di rotazione**

1

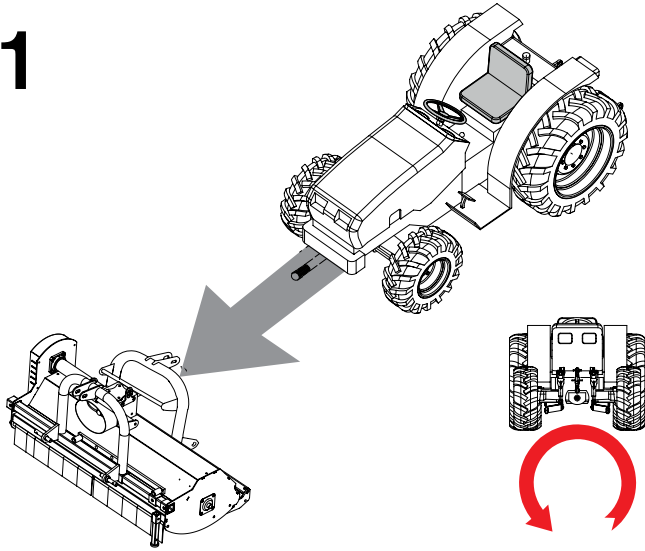

**Front machine**  
**Machine frontale**  
**Frontanbau**  
**Macchina frontale**

RPM – T/min – U/min – giri/min

540	1000	2000
A	B	C

2

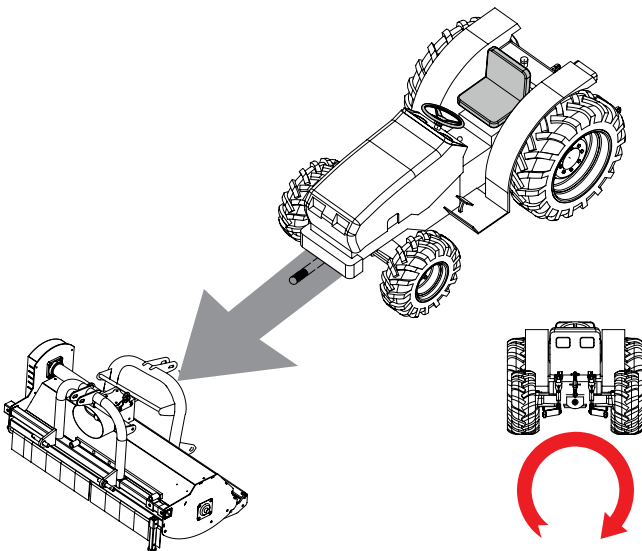

**Front machine**  
**Machine frontale**  
**Frontanbau**  
**Macchina frontale**

RPM – T/min – U/min – giri/min

540	1000	2000
D	E	F

**3**

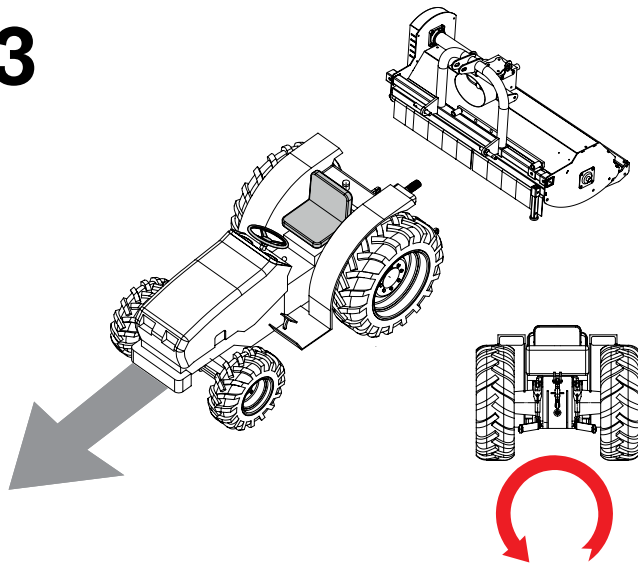

**Rear machine  
Machine arrière  
Heckanbau  
Macchina posteriore**

RPM – T/min – U/min – giri/min

540	1000	2000
G	H	L

**4**

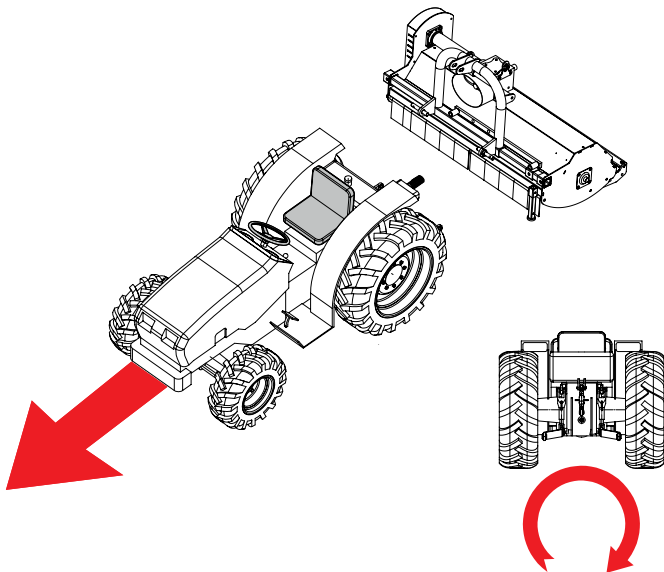

**Rear machine  
Machine arrière  
Heckanbau  
Macchina posteriore**

RPM – T/min – U/min – giri/min

540	1000	2000
M	N	P



# Ginger

Mulcher  
Broyeur  
Mulchgerät  
Trinciatrice

HP  
12 - 30

kW

9 - 22

rpm

540



cm 3-6 - inch 1-2,5



ENG

Light mulcher suitable for low HP tractors. It is easy to use and ideal for cutting grass and weeds in uncultivated fields.

FRA

Broyeur léger conçu pour tracteurs à faible puissance. Facile à utiliser, il est idéal pour couper l'herbe et les mauvaises herbes dans les champs vagues.

DEU

Leichter Schlegelmulcher, für Traktoren mit geringer Leistung geeignet. Er ist einfach zu bedienen und ideal zum häckseln auf unkultivierten Feldern.

ITA

Trinciatrice leggera adatta a trattori di piccola potenza. È facile da usare e ideale per il taglio di erbacce nei campi incolti.

## STANDARD FEATURES

- 3 POINT HITCH, CATEGORY 1
- ALUMINUM COMER GEARBOX 540 RPM WITH INTEGRATED FREE WHEEL DEVICE
- TWO OPTIBELT BELT TRANSMISSION WITH ADJUSTABLE TENSIONER
- ROTOR WITH "Y" BLADES OR HAMMERS
- ADJUSTABLE REAR ROLLER
- UNIVERSAL PTO SHAFT CATEGORY 1 - 700 MM

## CARACTÉRISTIQUES STANDARD



- ATTELAGE À 3 POINTS 1° CATÉGORIE
- BOITIER COMER EN ALUMINIUM 540 T/MIN AVEC ROUE LIBRE INTÉGRÉE
- TRANSMISSION PAR DEUX COURROIES OPTIBELT AVEC TENDEUR À VIS RÉGLABLE
- ROTOR AVEC COUTEAUX OU MARTEAUX
- ROULEAU ARRIÈRE RÉGLABLE
- CARDAN STANDARD 1° CATÉGORIE - 700 MM

## STANDARD EIGENSCHAFTEN

- DREIPUNKTBOCK-ANSCHLUß KATEGORIE 1
- 540 U/MIN COMER ALU-GETRIEBE MIT FREILAUF
- ANTRIEB MIT 2 OPTIBELT KEILRIEMEN UND EINSTELLBAREM SCHRAUBENSANNER
- ROTOR MIT Y-MESSERN ODER HAMMERSCHLEGEL
- VERSTELLBARE NACHLAUFWALZE
- STANDARD GELENKWELLE KATEGORIE 1 - 700 MM

## CARATTERISTICHE STANDARD

- ATTACCO A 3 PUNTI 1° CATEGORIA
- RIDUTTORE COMER IN ALLUMINIO 540 G/MIN CON RUOTA LIBERA INTEGRATA
- TRASMISSIONE CON DUE CINGHIE OPTIBELT CON TENDITORE A VITE REGISTRABILE
- ROTORE CON COLTELLI O MAZZE
- RULLO POSTERIORE REGOLABILE
- CARDANO STANDARD 1° CATEGORIA - 700 MM

COD-MOD	N.	hp					n.	n.	kg	lbs	€
			cm	in	cm	in					
Ginger 80	2C	12 - 30	80	32"	98	38"	24	12	114	250	
Ginger 96	2C	12 - 30	96	38"	111	43"	32	16	121	266	
Ginger 106	2C	12 - 30	106	42"	124	48"	32	16	128	282	
Ginger 125	2C	12 - 30	125	50"	137	53"	40	20	138	304	
Ginger 145	2C	12 - 30	145	57"	150	69"	40	20	150	330	

Cod.	OPTIONAL	kg	lbs	€
------	----------	----	-----	---



**C**

*Rotor with Y blades for universal use- grass  
Rotor avec couteaux pour utilisation universelle - herbe  
Rotor mit Y-Messer für den universellen Einsatz - Gras  
Rotore con coltelli per uso universale - erba*

- Ginger 80 C
- Ginger 96 C
- Ginger 106 C
- Ginger 125 C
- Ginger 145 C

Cod.	OPTIONAL	kg	lbs	€
------	----------	----	-----	---



**M**

*Rotor with hammers for specific use- raw land, brambles, pruning  
Rotor avec marteaux - terrains, ronces, élagages  
Rotor mit Hammerschlegel - für vernachlässigter Boden und Gebüsch  
Rotore con mazze - terreni incolti, rovi, potature*

- Ginger 80 M
- Ginger 96 M
- Ginger 106 M
- Ginger 125 M
- Ginger 145 M

**DIMENSIONS - DIMENSIONS - ABMESSUNGEN - INGOMBRI**

Type	A (cm)	B (cm)	C (cm)
Ginger 80	120	80	75
Ginger 96	120	80	75
Ginger 106	120	80	75
Ginger 125	150	80	75
Ginger 145	150	80	75

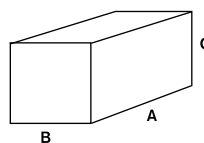

**PACKAGING - EMBALLAGE - VERPACKUNG - IMBALLAGGI**



- Single metal crate
- Caisse Métallique unitaire
- Einzelne Metall Palette
- Cassa singola

# Funny

Mulcher  
Broyeur  
Mulchgerät  
Trinciatrice

HP  
12 - 30

kW

10 - 22

rpm

540

 cm 5,5-13,5 - inch 2-5



ENG

This mulcher is designed for semi-professional use and works well with low HP tractors as it is light and flexible. It can be used to cut grass, weeds and small bushes.

FRA

Ce broyeur est indiqué pour des tracteurs avec une petite puissance et pour une utilisation semi professionnelle. Cette machine se caractérise par sa légèreté et son élasticité mais aussi pour sa capacité de couper aussi bien de l'herbe, que des petits arbustes etc. Broyeur facile et intuitif.

DEU

Dieser Schlegelmulcher ist für den semi-professionellen Einsatz konzipiert und passt gut zu Traktoren mit geringen PS da es leicht und elastisch ist. Es kann benutzt werden um Rasen, Gras und kleine Büsche zu mulchen.

ITA

Questa trinciatrice è adatta per trattori di piccola potenza per un utilizzo semi professionale; si caratterizza per la sua elasticità e leggerezza, unita a grande capacità di taglio di erba e piccoli arbusti. Facile, intuitiva e bella.

## STANDARD FEATURES

- 3 POINT HITCH, CATEGORY 1
- ALUMINUM GEARBOX 540 RPM WITH INTEGRATED FREE WHEEL DEVICE
- TWO BELT TRANSMISSION WITH ADJUSTABLE TENSIONER
- ROTOR WITH "Y" BLADES OR HAMMERS
- ADJUSTABLE AND EXTENDABLE REAR ROLLER
- UNIVERSAL PTO SHAFT CATEGORY 2 - 700 MM

## CARACTÉRISTIQUES STANDARD

- ATTELAGE À 3 POINTS 1° CATÉGORIE
- BOITIER EN ALUMINIUM 540 T/MIN. AVEC ROUE LIBRE INTÉGRÉE
- TRANSMISSION PAR DEUX COURROIES AVEC TENDEUR À VIS RÉGLABLE
- ROTOR À COUTEAUX OU MARTEAUX
- ROULEAU ARRIÈRE RÉGLABLE ET EXTENSIBLE
- CARDAN STANDARD 2° CATÉGORIE - 700 MM

## STANDARD EIGENSCHAFTEN

- DREIPUNKTBOCK-ANSCHLUß KATEGORIE 1
- ALUMINIUM-GETRIEBE 540 U/MIN MIT FREILAUF
- ANTRIEB MIT 2 KEILRIEMEN UND EINSTELLBAREM SCHRAUBENSANNER
- ROTOR MIT Y - MESSER ODER HÄMMERSCHLEGEL
- VERSTELLBARE UND VERLÄNGERBARE NACHLAUFWALZE
- STANDARD GELENKWELLE KATEGORIE 2 - 700 MM

## CARATTERISTICHE STANDARD

- ATTACCO A 3 PUNTI 1° CATEGORIA
- RIDUTTORE IN ALLUMINIO 540 G/MIN CON RUOTA LIBERA INTEGRATA
- TRASMISSIONE CON DUE CINGHIE CON TENDITORE A VITE REGISTRABILE.
- ROTORE CON COLTELLI O MAZZE
- RULLO POSTERIORE REGOLABILE ED ESTENSIBILE
- CARDANO STANDARD 2° CATEGORIA - 700 MM



COD-MOD	N.	hp							kg	lbs	€
			cm	in	cm	in	n.	n.			
<b>Funny 80</b>	<b>2C</b>	12 - 30	80	32"	100	40"	24	12	130	287	
<b>Funny 93</b>	<b>2C</b>	12 - 30	93	36"	115	46"	32	16	139	306	
<b>Funny 106</b>	<b>2C</b>	12 - 30	106	42"	120	48"	32	16	146	322	
<b>Funny 132</b>	<b>2C</b>	12 - 30	132	52"	155	62"	40	20	170	375	
<b>Funny 158</b>	<b>2C</b>	12 - 30	158	62"	180	72"	48	24	195	430	

Cod.	OPTIONAL	Type	€
	<b>C</b> <i>Rotor with Y blades for universal use- grass</i> <i>Rotor avec couteaux pour utilisation universelle - herbe</i> <i>Rotor mit Y-Messer für den universellen Einsatz - Gras</i> <i>Rotore con coltelli per uso universale - erba</i>	Funny 80 C	
		Funny 93 C	
		Funny 106 C	
		Funny 132 C	
		Funny 158 C	

Cod.	OPTIONAL	Type	€
	<b>M</b> <i>Rotor with hammers for specific use- raw land, brambles, pruning</i> <i>Rotor avec marteaux - terrains, ronces, élagages</i> <i>Rotor mit Hammerschlegel - für vernachlässigter Boden und Gebüsch</i> <i>Rotore con mazze - terreni incolti, rovi, potature</i>	Funny 80 M	
		Funny 93 M	
		Funny 106 M	
		Funny 132 M	
		Funny 158 M	

Cod.	OPTIONAL	Type	€
	<b>ER</b> <i>Extension Kit for rear roller</i> <i>Kit rouleau arrière- Grande Ejection</i> <i>Hintere Walze Verlängerungs kit</i> <i>Kit prolunga rullo posteriore</i>	Funny 80	
		Funny 93	
		Funny 106	
		Funny 132	
		Funny 158	

**DIMENSIONS - DIMENSIONS - ABMESSUNGEN - INGOMBRI**

Type	A (cm)	B (cm)	C (cm)
Funny 80	120	80	75
Funny 93	120	80	75
Funny 106	120	80	75
Funny 132	150	80	75
Funny 158	180	80	75

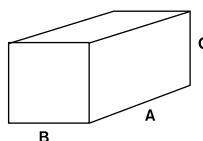

**PACKAGING - EMBALLAGE - VERPACKUNG - IMBALLAGGI**



- Single metal crate
- Caisse Métallique unitaire
- Einzelne Metall Palette
- Cassa singola

# Funny Top

Side shift mulcher

Broyeur déportable

Verschiebbares Mulchgerät

Trinciatrice spostabile

HP

12 - 30

kW

10 - 22

rpm

540



cm 5,5-13,5 - inch 2-5



ENG

This mulcher has side-shift and can work close to or under trees and bushes. It is designed for semi-professional use and works well with low HP tractors as it is light and flexible. It can be used to cut grass, weeds and small bushes.

FRA

Ce broyeur est indiqué pour des tracteurs de petite puissance et pour une utilisation semi professionnelle. Le déport manuel latéral permet de passer sous le feuillage des plantations en lignes. Cette machine se caractérise pour sa maniabilité et sa polyvalence à couper herbe, arbustes, etc.

DEU

Dieser Schlegelmulcher kann Seitlich verschoben werden so dass es unter Bäumen oder Büschen arbeiten kann. Es ist für den semi-professionellen Einsatz konzipiert und passt gut zu Traktoren mit geringen PS da es leicht und elastisch ist. Es kann benutzt werden um Rasen, Gras und kleine Büsche zu mulchen.

ITA

Trinciatrice indicata per piccole potenze per un utilizzo semi professionale; lo spostamento laterale consente di entrare sotto la chioma di piante e frutteti. Si caratterizza per la sua elasticità unita alla capacità di taglio di erba e piccoli arbusti.

## STANDARD FEATURES

- 3 POINT HITCH, CATEGORY 1
- ALUMINUM GEARBOX 540 RPM WITH INTEGRATED FREE WHEEL DEVICE
- TWO BELT TRANSMISSION WITH ADJUSTABLE TENSIONER
- ROTOR WITH "Y" BLADES OR HAMMERS
- ADJUSTABLE AND EXTENDABLE REAR ROLLER
- UNIVERSAL PTO SHAFT CATEGORY 2 - 1000 MM

## CARACTÉRISTIQUES STANDARD

- ATTELAGE À 3 POINTS 1° CATÉGORIE
- BOITIER EN ALUMINIUM 540 T/MIN AVEC ROUE LIBRE INTÉGRÉE
- TRANSMISSION PAR DEUX COURROIES AVEC TENDEUR À VIS RÉGLABLE
- ROTOR À COUTEAUX OU MARTEAUX
- ROULEAU ARRIÈRE RÉGLABLE ET EXTENSIBLE
- CARDAN STANDARD 2° CATÉGORIE - 1000 MM

## STANDARD EIGENSCHAFTEN

- DREIPUNKTBOCK-ANSCHLUß KATEGORIE 1
- ALUMINIUM-GETRIEBE 540 U/MIN MIT FREILAUF
- ANTRIEB MIT 2 KEILRIEMEN UND EINSTELLBAREM SCHRAUBENSPELLER
- ROTOR MIT Y - MESSER ODER HÄMMERSCHLEGEL
- VERSTELLBARE UND VERLÄNGERBARE NACHLAUFWALZE
- STANDARD GELENKWELLE KATEGORIE 2 - 1000 MM

## CARATTERISTICHE STANDARD

- ATTACCO A 3 PUNTI 1° CATEGORIA
- RIDUTTORE IN ALLUMINIO 540 G/MIN CON RUOTA LIBERA INTEGRATA
- TRASMISSIONE CON DUE CINGHIE CON TENDITORE A VITE REGISTRABILE
- ROTORE CON COLTELLI O MAZZE
- RULLO POSTERIORE REGOLABILE ED ESTENSIBILE
- CARDANO STANDARD 2° CATEGORIA - 1000 MM

COD-MOD	n.	hp	cm	in	cm	in	n.	n.	kg	lbs	€
<b>Funny Top 80</b>	<b>2C</b>	<b>12 - 30</b>	<b>80</b>	<b>32"</b>	<b>100</b>	<b>40"</b>	<b>24</b>	<b>12</b>	<b>142</b>	<b>313</b>	
<b>Funny Top 93</b>	<b>2C</b>	<b>12 - 30</b>	<b>93</b>	<b>36"</b>	<b>115</b>	<b>46"</b>	<b>32</b>	<b>16</b>	<b>149</b>	<b>328</b>	
<b>Funny Top 106</b>	<b>2C</b>	<b>12 - 30</b>	<b>106</b>	<b>42"</b>	<b>120</b>	<b>48"</b>	<b>32</b>	<b>16</b>	<b>156</b>	<b>344</b>	
<b>Funny Top 132</b>	<b>2C</b>	<b>12 - 30</b>	<b>132</b>	<b>52"</b>	<b>155</b>	<b>62"</b>	<b>40</b>	<b>20</b>	<b>170</b>	<b>375</b>	
<b>Funny Top 158</b>	<b>2C</b>	<b>12 - 30</b>	<b>158</b>	<b>62"</b>	<b>180</b>	<b>72"</b>	<b>48</b>	<b>24</b>	<b>196</b>	<b>432</b>	

Cod.	OPTIONAL	Type	€
	<b>C</b>	<i>Rotor with Y blades for universal use- grass</i>	
		<i>Rotor avec couteaux pour utilisation universelle - herbe</i>	
		<i>Rotor mit Y-Messer für den universellen Einsatz - Gras</i>	
		<i>Rotore con coltelli per uso universale - erba</i>	
		Funny Top 80 C	
		Funny Top 93 C	
		Funny Top 106 C	
		Funny Top 132 C	
		Funny Top 158 C	

Cod.	OPTIONAL	Type	€
	<b>M</b>	<i>Rotor with hammers for specific use- raw land, brambles, pruning</i>	
		<i>Rotor avec marteaux - terrains, ronces, élagages</i>	
		<i>Rotor mit Hammerschlegel - für vernachlässigter Boden und Gebüsch</i>	
		<i>Rotore con mazze - terreni incolti, rovi, potature</i>	
		Funny Top 80 M	
		Funny Top 93 M	
		Funny Top 106 M	
		Funny Top 132 M	
		Funny Top 158 M	

Cod.	OPTIONAL	Type	€
	<b>ER</b>	<i>Extension Kit for rear roller</i>	
		<i>Kit rouleau arrière- Grande Ejection</i>	
		<i>Hintere Walze Verlängerungs kit</i>	
		<i>Kit prolunga rullo posteriore</i>	
		Funny Top 80	
		Funny Top 93	
		Funny Top 106	
		Funny Top 132	
		Funny Top 158	

cm	80	106	132	158
A	57	57	69	87
B	30	56	69	82
C	87	113	138	169
D	70	96	109	122

**DIMENSIONS - DIMENSIONS - ABMESSUNGEN - INGOMBRI**

Type	A (cm)	B (cm)	C (cm)
Funny Top 80	120	80	75
Funny Top 93	120	80	75
Funny Top 106	120	80	75
Funny Top 132	150	80	75
Funny Top 158	180	80	75

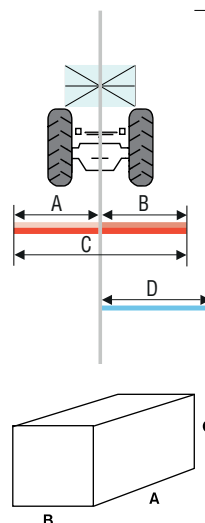

**PACKAGING - EMBALLAGE - VERPACKUNG - IMBALLAGGI**



- Single metal crate
- Caisse Métallique unitaire
- Einzelne Metall Palette
- Cassa singola



# Disco

**Reversible mulcher**  
**Broyeur reversible**  
**Reversibles Mulchgerät**  
**Trinciatrice reversibile**

**HP**  
**12 - 40**

**kW**

**9 - 30**

**rpm**

**540**



cm 2-11 - inch 1-4

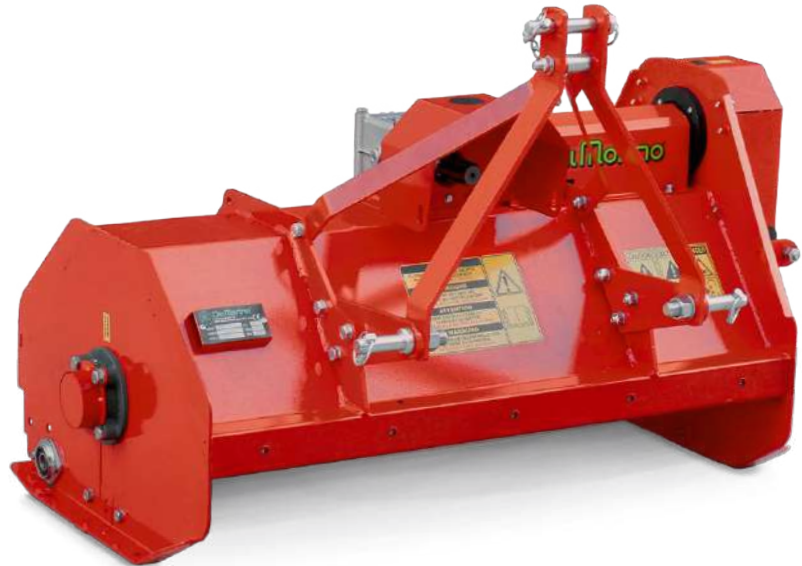

**ENG**

Light mulcher suitable for low HP tractors. Its large mulching chamber facilitates the mulching for a professional job.

**FRA**

Broyeur de branche étudié pour une utilisation semi-professionnel. Il assure un travail sur et efficace.

**DEU**

Für den semi-professionellen Einsatz geeignet. Er Garantiert sichere und effektive Häckselarbeiten.

**ITA**

Trinciatrice leggera adatta a trattori di piccola potenza. La sua grande cassa trinciante le consente una lavorazione professionale.

## STANDARD FEATURES

- 3 POINT HITCH, CATEGORY 1
- ALUMINUM GEARBOX 540 RPM WITH INTEGRATED FREE WHEEL DEVICE
- TWO BELT TRANSMISSION WITH ADJUSTABLE TENSIONER
- COUNTERBLADE DEVICE
- ROTOR WITH "Y" BLADES OR HAMMERS
- ADJUSTABLE AND EXTENDABLE REAR ROLLER
- UNIVERSAL PTO SHAFT CATEGORY 2 - 700 MM

## CARACTÉRISTIQUES STANDARD

- ATTELAGE À 3 POINTS 1° CATÉGORIE
- BOITIER EN ALUMINIUM 540 T/MIN AVEC ROUE LIBRE INTÉGRÉE
- TRANSMISSION PAR DEUX COURROIES AVEC TENDEUR À VIS RÉGLABLE
- CONTRE-COUTEAUX DE SÉRIE
- ROTOR AVEC COUTEAUX OU MARTEAUX
- ROULEAU ARRIÈRE RÉGLABLE ET EXTENSIBLE
- CARDAN STANDARD 2° CATÉGORIE - 700 MM

## STANDARD EIGENSCHAFTEN

- DREIPUNKTBOCK-ANSCHLUß KATEGORIE 1
- 540 U/MIN ALU-GETRIEBE MIT FREILAUF
- ANTRIEB MIT 2 KEILRIEMEN UND EINSTELLBAREM SCHRAUBENSANNER
- GEGEN-MESSER DISPOSITIV ALS SERIENAUSSTATTUNG
- ROTOR MIT Y-MESSERN ODER HAMMERSCHLEGEL
- VERSTELLBARE UND VERLÄNGERBARE NACHLAUFWALZE
- STANDARD GELENKWELLE KATEGORIE 2 - 700 MM

## CARATTERISTICHE STANDARD

- ATTACCO A 3 PUNTI 1° CATEGORIA
- RIDUTTORE IN ALLUMINIO 540 G/MIN CON RUOTA LIBERA INTEGRATA
- TRASMISSIONE CON DUE CINGHIE CON TENDITORE A VITE REGISTRABILE
- DISPOSITIVO CONTRO COLTELLI DI SERIE
- ROTORE CON COLTELLI O MAZZE
- RULLO POSTERIORE REGOLABILE ED ESTENSIBILE
- CARDANO STANDARD 2° CATEGORIA - 700 MM

COD-MOD	N.	hp									€
			cm	in	cm	in	n.	n.	kg	lbs	
Disco 96	2C	12 - 40	93	36"	107	42"	32	16	150	330	
Disco 115	2C	12 - 40	106	42"	120	47"	32	16	160	353	
Disco 125	2C	12 - 40	119	47"	133	52"	40	20	175	386	
Disco 145	2C	12 - 40	132	52"	146	58"	40	20	195	430	
Disco 165	2C	12 - 40	158	62"	172	68"	48	24	235	518	

Cod.	OPTIONAL	€
------	----------	---



**C**

*Rotor with Y blades for universal use- grass  
Rotor avec couteaux pour utilisation universelle - herbe  
Rotor mit Y-Messer für den universellen Einsatz - Gras  
Rotore con coltelli per uso universale - erba*

- Disco 96 C
- Disco 115 C
- Disco 125 C
- Disco 145 C
- Disco 165 C

Cod.		€
------	--	---



**M**

*Rotor with hammers for specific use- raw land, brambles, pruning  
Rotor avec marteaux - terrains, ronces, élagages  
Rotor mit Hammerschlegel - für vernachlässigter Boden und Gebüsche  
Rotore con mazze - terreni incolti, rovi, potature*

- Disco 96 M
- Disco 115 M
- Disco 125 M
- Disco 145 M
- Disco 165 M

Cod.		€
------	--	---



**S**

*Skid Kit for heavy wear situations  
Surpatins Lateraux  
Zusätzlicher Kufen Kit  
Kit pattini di usura supplementari*

Cod.	Type	€
------	------	---



**FONT**

*Cast iron gear box  
Boitier en fonte  
Gusseisenes Getriebe  
Moltiplicatore in ghisa*

- Disco 96
- Disco 115
- Disco 125
- Disco 145
- Disco 165

Cod.	Type	€
------	------	---

**FONT  
1000**

*Gear box 1000 RPM  
Boitier pour PDF à 1000  
Getriebe mit 1000  
Riduttori per PDF a 1000*

**DIMENSIONS - DIMENSIONS - ABMESSUNGEN - INGOMBRI**

Type	A (cm)	B (cm)	C (cm)
Disco 96	120	80	85
Disco 115	130	80	85
Disco 125	150	80	85

Type	A (cm)	B (cm)	C (cm)
Disco 145	160	80	85
Disco 165	190	80	85

**PACKAGING - EMBALLAGE - VERPACKUNG - IMBALLAGGI**



- Single metal crate
- Caisse Métallique unitaire
- Einzelne Metall Palette
- Cassa singola

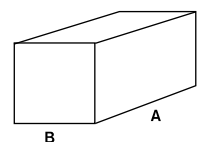

# Disco Top

Side shift mulcher  
Broyeur déportable  
Verschiebbares Mulchgerät  
Trinciatrice spostabile

HP  
12 - 40

kW

9 - 30

rpm

540



cm 2-11 - inch 1-4



ENG

This mulcher has side-shift and can work close to or under trees and bushes. Light mulcher suitable for low HP tractors. Its large mulching chamber facilitates the mulching for a professional job.

## STANDARD FEATURES

- 3 POINT HITCH CATEGORY 1 WITH MECHANICAL SIDE SHIFT
- ALUMINUM GEARBOX 540 RPM WITH INTEGRATED FREE WHEEL DEVICE
- TWO BELT TRANSMISSION WITH ADJUSTABLE TENSIONER
- COUNTERBLADE DEVICE
- ROTOR WITH "Y" BLADES OR HAMMERS
- ADJUSTABLE AND EXTENDABLE REAR ROLLER
- UNIVERSAL PTO SHAFT CATEGORY 2 - 1000 MM

FRA

Broyeur de branche étudié pour une utilisation semi-professionnel. Il assure un travail sur et efficace. Le déport manuel latéral permet de passer sous le feuillage des plantations en lignes.

## CARACTÉRISTIQUES STANDARD

- ATTELAGE À 3 POINTS 1° CATÉGORIE DÉPORTABLE MÉCANIQUE
- BOITIER EN ALUMINIUM 540 T/MIN AVEC ROUE LIBRE INTÉGRÉE
- TRANSMISSION PAR DEUX COURROIES AVEC TENDEUR À VIS RÉGLABLE
- CONTRE-COUTEAUX DE SÉRIE
- ROTOR AVEC COUTEAUX OU MARTEAUX
- ROULEAU ARRIÈRE RÉGLABLE ET EXTENSIBLE
- CARDAN STANDARD 2° CATÉGORIE - 1000 MM

DEU

Der Disco Top kann mechanisch seitlich verschoben werden, ist für den semi-professionellen Einsatz geeignet. Er Garantiert sichere und effektive Häckselarbeiten.

## STANDARD EIGENSCHAFTEN

- DREIPUNKTBOCK-ANSCHLUß KATEGORIE 1 MECHANISCH
- 540 U/MIN ALU-GETRIEBE MIT FREILAUF
- ANTRIEB MIT 2 KEILRIEMEN UND EINSTELLBAREM SCHRAUBENSPELLER
- GEGEN-MESSER DISPOSITIV ALS SERIENAUSSTATTUNG
- ROTOR MIT Y-MESSERN ODER HAMMERSCHLEGEL
- VERSTELLBARE UND VERLÄNGERBARE NACHLAUFWALZE
- STANDARD GELENKWELLE KATEGORIE 2 - 1000 MM

ITA

Trinciatrice leggera adatta a trattori di piccola potenza. La sua grande cassa trinciante le consente una lavorazione professionale. Lo spostamento laterale consente di entrare sotto la chioma di piante e frutteti.

## CARATTERISTICHE STANDARD

- ATTACCO A 3 PUNTI 1° CATEGORIA CON SPOSTAMENTO MECCANICO
- RIDUTTORE IN ALLUMINIO 540 G/MIN CON RUOTA LIBERA INTEGRATA
- TRASMISSIONE CON DUE CINGHIE CON TENDITORE A VITE REGISTRABILE
- DISPOSITIVO CONTRO COLTELLI DI SERIE
- ROTORE CON COLTELLI O MAZZE
- RULLO POSTERIORE REGOLABILE ED ESTENSIBILE
- CARDANO STANDARD 2° CATEGORIA - 1000 MM



COD-MOD	N.	hp	cm	in	cm	in	n.	n.	kg	lbs
Disco Top 96	2C	12 - 40	93	36"	107	42"	32	16	150	330
Disco Top 115	2C	12 - 40	106	42"	120	47"	32	16	160	353
Disco Top 125	2C	12 - 40	119	47"	133	52"	40	20	175	386
Disco Top 145	2C	12 - 40	132	52"	146	58"	40	20	195	430
Disco Top 165	2C	12 - 40	158	62"	172	68"	48	24	235	518

Cod.	OPTIONAL
------	----------



**C**

*Rotor with Y blades for universal use- grass  
Rotor avec couteaux pour utilisation universelle - herbe  
Rotor mit Y-Messer für den universellen Einsatz - Gras  
Rotore con coltelli per uso universale - erba*

- Disco Top 96 C
- Disco Top 115 C
- Disco Top 125 C
- Disco Top 145 C
- Disco Top 165 C

Cod.	
------	--



**M**

*Rotor with hammers for specific use- raw land, brambles, pruning  
Rotor avec marteaux - terrains, ronces, élagages  
Rotor mit Hammerschlegel - für vernachlässigter Boden und Gebüsche  
Rotore con mazze - terreni incolti, rovi, potature*

- Disco Top 96 M
- Disco Top 115 M
- Disco Top 125 M
- Disco Top 145 M
- Disco Top 165 M

Cod.	
------	--



**S**

*Skid Kit for heavy wear situations  
Surpatins Lateraux  
Zusätzlicher Kufen Kit  
Kit pattini di usura supplementari*

Cod.	Type
------	------



**FONT**

*Cast iron gear box  
Boitier en fonte  
Gusseisenes Getriebe  
Moltiplicatore in ghisa*

- Disco Top 96
- Disco Top 115
- Disco Top 125
- Disco Top 145
- Disco Top 165

Cod.	
------	--



**H**

*Hydraulic kit for side-shift  
Dispositif de déport hydraulique du troisième point  
Hydraulische Verschiebung  
Dispositivo di spostamento idraulico dell'attacco a tre punti*

**DIMENSIONS - DIMENSIONS - ABMESSUNGEN - INGOMBRI**

Type	A (cm)	B (cm)	C (cm)
Disco Top 96	120	80	85
Disco Top 115	130	80	85
Disco Top 125	150	80	85
Disco Top 145	160	80	85
Disco Top 165	190	80	85

cm	96	115	125	145	165
A	62	69	75	82	82
B	40	55	62	68	94
C	110	124	137	150	176
D	79	86	93	99	124

**PACKAGING - EMBALLAGE - VERPACKUNG - IMBALLAGGI**



- Single metal crate
- Caisse Métallique unitaire
- Einzelne Metall Palette
- Cassa singola

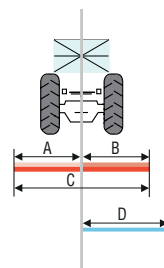
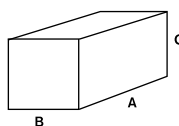

# Centurion

Side shift mulcher

Broyeur déportable

Verschiebbares Mulchgerät

Trinciatrice spostabile

HP

15 - 50

kW

12 - 40

rpm

540



cm 1-9 - inch 0,5-4



ENG

A practical, multipurpose flail mower with manual or optional hydraulic side shift for professional farmers. The power transmission system is the best available and is suitable for tractors up to 50 HP. The quality, performance and price are outstanding.

## STANDARD FEATURES

- 3 POINT HITCH CATEGORY 1 WITH MECHANICAL SIDE SHIFT (OR HYDRAULIC OPTIONAL)
- CAST IRON GEAR BOX 540 RPM WITH INTEGRATED FREE WHEEL DEVICE AND PASS-THROUGH SHAFT
- 2 BELT DRIVE TRANSMISSION WITH SCREW ADJUSTABLE TENSIONER (STANDARD), 3 BELT DRIVE TRANSMISSION (OPTIONAL)
- ROTOR WITH BLADES OR HAMMERS
- ADJUSTABLE REAR ROLLER
- UNIVERSAL PTO SHAFT CATEGORY 4 - 900 MM
- SIDE SHIFT: 106 = 200 MM; 132 - 158 = 280 MM

FRA

Polyvalent et pratique pour l'utilisateur professionnel, cette machine offre au client une technologie la plus avancée par rapport à ce qui existe aujourd'hui. Cette machine peut équiper des tracteurs d'une puissance de 50 HP maximum. Produit sûr et avec un excellent rapport qualité-prix.

## CARACTÉRISTIQUES STANDARD

- ATTELAGE À 3 POINTS 1° CATÉGORIE DÉPORTABLE MÉCANIQUE (OU HYDRAULIQUE OPTIONNEL)
- BOITIER EN FONTE 540 T/MIN AVEC ROUE LIBRE INTÉGRÉE ET ARBRE PASSANT
- TRANSMISSION PAR 2 COURROIES VENTILÉES PAR TENDEUR À VIS RÉGLABLE (DE SÉRIE), 3 COURROIES (OPTION)
- ROTOR AVEC COUTEAUX OU MARTEAUX
- ROULEAU ARRIÈRE RÉGLABLE
- CARDAN STANDARD 4° CATÉGORIE - 900 MM
- DEPORT LATÉRALE: 106 = 200 MM; 132 - 158 = 280 MM

DEU

Ein praktischer, vielseitiger Schlegelmulcher mit Mechanischer oder Hydraulischer (Option) Seitenverschiebung. Das Getriebe ist technisch auf den letzten Stand und ist für Traktoren bis 50 PS geeignet. Der Preis/Leistungs Verhältnis und die Qualität sind ausserordentlich.

## STANDARD EIGENSCHAFTEN

- DREIPUNKTBOCK-ANSCHLUß KATEGORIE 1 MECHANISCH (ODER HYDRAULISCH) VERSCHIEBBAR
- GUSSEISENENES GETRIEBE 540 U/MIN MIT FREILAUF UND DOPPELTE EINGANGSWELLE
- ANTRIEB MIT 2 KEILRIEMEN UND EINSTELLBAREM SCHRAUBENSPELLER, 3 KEILRIEMEN (OPTION)
- ROTOR MIT Y-MESSER ODER HAMMERSCHLEGEL
- VERSTELLBARE HINTERE NACHLAUFWALZE
- STANDARD GELENKWELLE KATEGORIE 4 - 900 MM
- VERSCHIEBUNG: 106 = 200 MM; 132 - 158 = 280 MM

ITA

Polyvalente e pratico per l'agricoltore professionista, racchiude nei suoi cinematismi quanto di meglio possa offrire la più recente tecnologia delle trasmissioni. Può essere applicata a trattori di potenza fino a 50 HP. Affidabile, di qualità ed economico.

## CARATTERISTICHE STANDARD

- ATTACCO A 3 PUNTI 1° CATEGORIA CON SPOSTAMENTO MECCANICO (O IDRAULICO OPZIONALE)
- RIDUTTORE IN GHISA 540 G/MIN CON RUOTA LIBERA INTEGRATA E ALBERO PASSANTE
- TRASMISSIONE A 2 CINGHIE VENTILATE CON TENDITORE A VITE REGISTRABILE (DI SERIE), 3 CINGHIE IN OPZIONE
- ROTORE A COLTELLI O A MAZZE
- RULLO POSTERIORE REGOLABILE
- CARDANO STANDARD 4° CATEGORIA - 900 MM
- SPOSTAMENTO LATÉRALE: 106 = 200 MM; 132 - 158 = 280 MM

COD-MOD	N.	hp									€
			cm	in	cm	in	n.	n.			
<b>Centurion 106</b>	<b>2C</b>	<b>15 - 50</b>	<b>106</b>	<b>42"</b>	<b>125</b>	<b>50"</b>	<b>32</b>	<b>16</b>	<b>218</b>	<b>481</b>	
<b>Centurion 132</b>	<b>2C</b>	<b>15 - 50</b>	<b>132</b>	<b>52"</b>	<b>150</b>	<b>60"</b>	<b>40</b>	<b>20</b>	<b>257</b>	<b>567</b>	
<b>Centurion 158</b>	<b>2C</b>	<b>15 - 50</b>	<b>158</b>	<b>62"</b>	<b>180</b>	<b>72"</b>	<b>48</b>	<b>24</b>	<b>285</b>	<b>628</b>	
<b>Centurion 186</b>	<b>3C</b>	<b>15 - 50</b>	<b>186</b>	<b>73"</b>	<b>206</b>	<b>81"</b>	<b>56</b>	<b>28</b>	<b>349</b>	<b>769</b>	

Cod.	OPTIONAL	Type	€
	<b>C</b>	<i>Rotor with Y blades for universal use- grass</i>	Centurion 106 C
		<i>Rotor avec couteaux pour utilisation universelle - herbe</i>	Centurion 132 C
		<i>Rotor mit Y-Messer für den universellen Einsatz - Gras</i>	Centurion 158 C
		<i>Rotore con coltelli per uso universale - erba</i>	Centurion 186 C

Cod.	OPTIONAL	Type	€
	<b>M</b>	<i>Rotor with hammers for specific use- raw land, brambles, pruning</i>	Centurion 106 M
		<i>Rotor avec marteaux - terrains, ronces, élagages</i>	Centurion 132 M
		<i>Rotor mit Hammerschlegel - für vernachlässigter Boden und Gebüsch</i>	Centurion 158 M
		<i>Rotore con mazze - terreni incolti, rovi, potature</i>	Centurion 186 C

Cod.	OPTIONAL	Type	€
<b>H</b>	<i>Hydraulic kit for side-shift</i> <i>Dispositif de déport hydraulique du troisième point</i> <i>Hydraulische Verschiebung</i> <i>Dispositivo di spostamento idraulico dell'attacco a tre punti</i>		

**3C**  
 3 belt kit  
 Kit 3 courroies  
 3 Riemen Kit  
 Kit 3 cinghie

cm	106	132	158	186
A	56	69	82	95
B	56	69	82	95
C	112	138	164	190
D	76	97	110	123

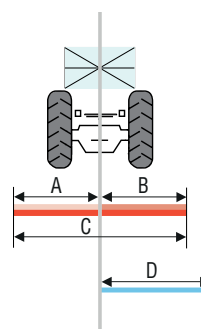

**DIMENSIONS - DIMENSIONS - ABMESSUNGEN - INGOMBRI**

Type	A (cm)	B (cm)	C (cm)
Centurion 106	125	85	95
Centurion 132	155	85	95
Centurion 158	185	85	95
Centurion 186	205	85	95

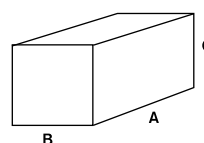

**PACKAGING - EMBALLAGE - VERPACKUNG - IMBALLAGGI**



- Single metal crate
- Caisse Métallique unitaire
- Einzelne Metall Palette
- Cassa singola



# Flipper

Reversible mulcher  
Broyeur réversible  
Reversibles Mulchgerät  
Trinciatrice reversibile

HP  
15 - 70

kW

12 - 50

rpm

540 / 1000 / 2000



cm 1,5-10 - inch 0,5-4



ENG

Every company has some fixed points that define its success and the FLIPPER is one of them. It is one of the best selling models thanks to its design, reliability and practicality (it can be easily changed from rear to front mount). It is suitable for tractors of up to 70 HP.

FRA

Notre entreprise préserve avec conviction les points forts qui en déterminent son succès. Cette machine est un des modèles le plus vendu grâce au design et à sa simplicité d'utilisation. Cette machine peut être utilisée avec des tracteurs de dimensions moyennes et d'une puissance allant jusqu'à 70 HP.

DEU

Jedes Unternehmen hat einige Eckpunkte die seinen Erfolg definieren und der FLIPPER ist einer davon. Es ist einer der meist verkaufte Maschinen dank sein Konzept, Zuverlässigkeit und Vielseitigkeit (es kann ohne viel Mühe vom Heck auf Frontanbau umgebaut werden). Es ist für Traktoren bis 70 PS geeignet.

ITA

Ogni azienda conserva con chiarezza alcuni punti fissi che ne hanno determinato il successo, il FLIPPER è uno dei modelli più venduti, grazie al suo design e praticità di utilizzo. Può essere applicato a trattori di medie dimensioni fino a 70 CV.

## STANDARD FEATURES

- 3 POINT HITCH, CATEGORY 1 AND 2, REVERSIBLE
- CAST IRON GEARBOX 540 RPM WITH INTEGRATED FREE WHEEL DEVICE AND PASS THROUGH SHAFT
- STANDARD 3 BELT DRIVE TRANSMISSION WITH SCREW ADJUSTABLE TENSIONER
- ROTOR WITH "Y" BLADES OR HAMMERS
- ADJUSTABLE REAR ROLLER
- ADJUSTABLE SKIDS
- MOUNTING POINTS FOR SIDE SHIFT
- UNIVERSAL PTO SHAFT CATEGORY 4 - 900 MM

## CARACTÉRISTIQUES STANDARD

- ATTELAGE À 3 POINTS 1° ET 2° CATÉGORIE, RÉVERSIBLE
- BOITIER EN FONTE 540 T/MIN AVEC ROUE LIBRE INTÉGRÉE ET ARBRE PASSANT
- TRANSMISSION PAR 3 COURROIES VENTILÉES AVEC TENDEUR À VIS RÉGLABLE DE SÉRIE
- ROTOR AVEC COUTEAUX OU MARTEAUX
- ROULEAU ARRIÈRE RÉGLABLE
- PATINS RÉGLABLES
- PRÉDISPOSÉ POUR KIT DE MONTAGE DÉPLACEMENT LATÉRAL
- CARDAN STANDARD 4° CATÉGORIE - 900 MM

## STANDARD EIGENSCHAFTEN

- DREIPUNKTBOCK-ANSCHLUß KATEGORIE 1 UND 2, REVERSIBLEN
- GUSSEISENES GETRIEBE 540 U/ MIN MIT FREILAUF UND DOPPELTE EINGANGSWELLE
- ANTRIEB MIT 3 KEILRIEMEN
- ROTOR MIT Y-MESSER ODER HAMMERSCHLEGEL
- VERSTELLBARE HINTERE NACHLAUFWALZE
- VERSTELLBARE KUFEN
- KIT ANSCHLÜSS FÜR SEITENVERSCHIEBUNG
- STANDARD GELENKWELLE KATEGORIE 4 - 900 MM

## CARATTERISTICHE STANDARD

- ATTACCO A 3 PUNTI 1° E 2° CATEGORIA REVERSIBILE
- RIDUTTORE IN GHISA 540 G/MIN CON RUOTA LIBERA INTEGRATA E ALBERO PASSANTE
- TRASMISSIONE A 3 CINGHIE CON TENDITORE A VITE REGISTRABILE DI SERIE
- ROTORE CON COLTELLI O MAZZE
- RULLO POSTERIORE REGOLABILE
- SLITTE REGOLABILI
- PREDISPOSTO PER MONTAGGIO KIT SPOSTAMENTO LATERALE
- CARDANO STANDARD 4° CATEGORIA - 900 MM

COD-MOD	N.	hp	cm	in	cm	in	n.	n.	kg	lbs	€
<b>Flipper 80</b>	<b>2C</b>	<b>15 - 70</b>	<b>80</b>	<b>32"</b>	<b>100</b>	<b>40"</b>	<b>24</b>	<b>12</b>	<b>176</b>	<b>388</b>	
<b>Flipper 106</b>	<b>2C</b>	<b>15 - 70</b>	<b>106</b>	<b>42"</b>	<b>130</b>	<b>52"</b>	<b>32</b>	<b>16</b>	<b>200</b>	<b>441</b>	
<b>Flipper 132</b>	<b>3C</b>	<b>15 - 70</b>	<b>132</b>	<b>50"</b>	<b>155</b>	<b>62"</b>	<b>40</b>	<b>20</b>	<b>255</b>	<b>562</b>	
<b>Flipper 158</b>	<b>3C</b>	<b>15 - 70</b>	<b>158</b>	<b>62"</b>	<b>180</b>	<b>72"</b>	<b>48</b>	<b>24</b>	<b>288</b>	<b>635</b>	
<b>Flipper 186</b>	<b>3C</b>	<b>15 - 70</b>	<b>186</b>	<b>72"</b>	<b>205</b>	<b>82"</b>	<b>56</b>	<b>28</b>	<b>324</b>	<b>714</b>	
<b>Flipper 214</b>	<b>3C</b>	<b>15 - 70</b>	<b>214</b>	<b>85"</b>	<b>230</b>	<b>92"</b>	<b>64</b>	<b>32</b>	<b>438</b>	<b>966</b>	

Cod.	OPTIONAL	Type	€
------	----------	------	---



**C**

*Rotor with Y blades for universal use- grass  
Rotor avec couteaux pour utilisation universelle - herbe  
Rotor mit Y-Messer für den universellen Einsatz - Gras  
Rotore con coltelli per uso universale - erba*

- Flipper 80 C
- Flipper 106 C
- Flipper 132 C
- Flipper 158 C
- Flipper 186 C
- Flipper 214 C

Cod.	Type	€
------	------	---



**M**

*Rotor with hammers for specific use- raw land, brambles, pruning  
Rotor avec marteaux - terrains, ronces, élagages  
Rotor mit Hammerschlegel - für vernachlässigter Boden und Gebüsch  
Rotore con mazze - terreni incolti, rovi, potature*

- Flipper 80 M
- Flipper 106 M
- Flipper 132 M
- Flipper 158 M
- Flipper 186 M
- Flipper 214 M

Cod.	Type	€
------	------	---



**H**

*Hydraulic kit for side-shift  
Dispositif de déport hydraulique du troisième point  
Hydraulische Verschiebung  
Dispositivo di spostamento idraulico dell'attacco a tre punti*

- Flipper 106 H
- Flipper 132 H
- Flipper 158 H
- Flipper 186 H
- Flipper 214 H

Cod.	Type	€
------	------	---



**V**

*Side shift by screw  
Dispositif de déport par vis du troisième point  
Spindelverschiebung  
Dispositivo di spostamento a vite dell'attacco a tre punti*

- Flipper 106
- Flipper 132
- Flipper 158
- Flipper 186
- Flipper 214

Cod.	Type	€
------	------	---



**R1**  
**R2**

*Gear box 1000 RPM or 2000 RPM  
Boîtier pour PDF à 1000/2000 tours  
Getriebe mit 1000 oder 2000 U/min  
Riduttori per PDF a 1000 o 2000 RPM*

- 1.000 rpm
- 2.000 rpm

**DIMENSIONS - DIMENSIONS - ABMESSUNGEN - INGOMBRI**

Type	A (cm)	B (cm)	C (cm)
Flipper 80	120	85	95
Flipper 106	125	85	95
Flipper 132	155	85	95

Type	A (cm)	B (cm)	C (cm)
Flipper 158	185	85	95
Flipper 186	205	85	95
Flipper 214	235	85	95

**PACKAGING - EMBALLAGE - VERPACKUNG - IMBALLAGGI**



- Single metal crate
- Caisse Métallique unitaire
- Einzelne Metall Palette
- Cassa singola

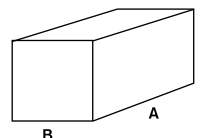

# Farm

**Reversible mulcher**  
**Broyeur reversible**  
**Reversibles Mulchgerät**  
**Trinciatrice reversibile**

**HP**  
**50 - 80**

kW

40 - 60

rpm

540 / 1000 / 2000



cm 2,5-5,5 - inch 1-2



ENG

A professional mulcher for demanding farmers with 3-belt drive and suitable for medium to high horse power tractors. Multipurpose with side shift and reversible mounting.

FRA

Machine professionnelle indiquée pour les agriculteurs exigeantes, avec 3 courroies de transmission, elle est destinée aux tracteurs de moyennes et grandes puissances. Etant réversible et déportable elle est dotée d'une grande polyvalence.

DEU

Ein professioneller Schlegelmulcher für den anspruchsvollen Bauern mit 3 Keilriemen und für Traktoren von mittel bis hohe PS geeignet. Vielseitig mit Seitenverschiebung und reversiblen Anbau.

ITA

Macchina professionale che si rivolge ad agricoltori e contoterzisti esigenti, è adatta ad un trattore di medie potenze, reversibile e spostabile: per posizioni a vite o idraulica.

## STANDARD FEATURES

- REVERSIBLE, SIDE SHIFT 3 POINT HITCH, CATEGORY 1
- CAST IRON GEAR BOX WITH INTEGRATED FREE WHEEL DEVICE AND PASS THROUGH SHAFT
- 3 BELT TRANSMISSION, VENTILATED WITH ADJUSTABLE TENSIONER
- ROTOR WITH HAMMERS OR BLADES
- ADJUSTABLE REAR ROLLER
- ADJUSTABLE SKIDS
- UNIVERSAL PTO SHAFT CATEGORY 5 - 900 MM

## CARACTÉRISTIQUES STANDARD

- ATTELAGE À 3 POINTS, 1<sup>o</sup> CATÉGORIE, RÉVERSIBLE ET DEPORTABLE
- BOITIER EN FONTE 540 T/MIN AVEC ROUE LIBRE INTÉGRÉE ET ARBRE PASSANT
- TRANSMISSION PAR 3 COURROIES AVEC TENDEUR À VIS RÉGLABLE
- ROTOR AVEC COUTEAUX OU MARTEAUX
- ROULEAU ARRIÈRE RÉGLABLE
- PATINS RÉGLABLES
- CARDAN STANDARD 5<sup>o</sup> CATÉGORIE - 900 MM





## STANDARD EIGENSCHAFTEN

- DREIPUNKTBOCK KATEGORIE 1 SEITEN VERSCHIEBBAR UND REVERSIBEL
- GUSSEISENES GETRIEBE 540 U/MIN MIT FREILAUF UND DOPPELTE EINGANGSWELLE
- ANTRIEB MIT 3 KEILRIEMEN MIT LÜFTUNG UND EINSTELLBAREM SCHRAUBENSPELLER
- ROTOR MIT Y-MESSERN ODER HAMMERSCHLEGEL
- VERSTELLBARE NACHLAUFWALZE
- VERSTELLBARE KUFEN
- STANDARD GELENKWELLE KATEGORIE 5 - 900 MM

## CARATTERISTICHE STANDARD

- ATTACCO A 3 PUNTI 1<sup>o</sup> CATEGORIA REVERSIBILE E SPOSTABILE
- RIDUTTORE IN GHISA 540 G/MIN CON RUOTA LIBERA INTEGRATA E ALBERO PASSANTE
- TRASMISSIONE CON 3 CINGHIE CON TENDITORE A VITE REGISTRABILE
- ROTORE CON COLTELLI O MAZZE
- RULLO POSTERIORE REGOLABILE
- SLITTE REGOLABILI
- CARDANO STANDARD 5<sup>o</sup> CATEGORIA - 900 MM



COD-MOD	n.	hp									kg	lbs	€
			cm	in	cm	in	n.	n.					
<b>Farm 158</b>	<b>3C</b>	<b>50 - 80</b>	<b>158</b>	62"	<b>185</b>	74"	<b>48</b>	<b>24</b>	<b>405</b>	<b>893</b>			
<b>Farm 186</b>	<b>3C</b>	<b>50 - 80</b>	<b>186</b>	72"	<b>210</b>	84"	<b>56</b>	<b>28</b>	<b>442</b>	<b>974</b>			
<b>Farm 214</b>	<b>3C</b>	<b>50 - 80</b>	<b>214</b>	85"	<b>235</b>	94"	<b>64</b>	<b>32</b>	<b>499</b>	<b>1100</b>			

Cod.	OPTIONAL	Type	€
------	----------	------	---



**C**

*Rotor with Y blades for universal use- grass  
Rotor avec couteaux pour utilisation universelle - herbe  
Rotor mit Y-Messer für den universellen Einsatz - Gras  
Rotore con coltelli per uso universale - erba*

Farm 158 C

Farm 186 C

Farm 214 C

Cod.	OPTIONAL	Type	€
------	----------	------	---



**M**

*Rotor with hammers for specific use- raw land, brambles, pruning  
Rotor avec marteaux - terrains, ronces, élagages  
Rotor mit Hammerschlegel - für vernachlässigter Boden und Gebüsche  
Rotore con mazze - terreni incolti, rovi, potature*

Farm 158 M

Farm 186 M

Farm 214 M

Cod.	OPTIONAL	Type	€
------	----------	------	---



**H**

*Hydraulic kit for side-shift  
Dispositif de déport hydraulique du troisième point  
Hydraulische Verschiebung  
Dispositivo di spostamento idraulico dell'attacco a tre punti*

Cod.	OPTIONAL	Type	€
------	----------	------	---



**V**

*Side shift by screw  
Dispositif de déport par vis du troisième point  
Spindelverschiebung  
Dispositivo di spostamento a vite dell'attacco a tre punti*

Cod.	OPTIONAL	Type	€
------	----------	------	---



**R1**  
**R2**

*Gear box 1000 RPM or 2000 RPM  
Boîtier pour PDF à 1000/2000 tours  
Getriebe mit 1000 oder 2000 U/min  
Riduttori per PDF a 1000 o 2000 RPM*

1.000 rpm

2.000 rpm

**DIMENSIONS - DIMENSIONS - ABMESSUNGEN - INGOMBRI**

Type	A (cm)	B (cm)	C (cm)
Farm 158	185	85	95
Farm 186	205	85	95
Farm 214	235	85	95

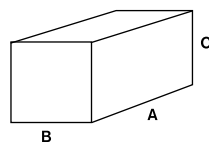

**PACKAGING - EMBALLAGE - VERPACKUNG - IMBALLAGGI**



- Single metal crate
- Caisse Métallique unitaire
- Einzelne Metall Palette
- Cassa singola

# Levante

Reversible mulcher  
Broyeur reversible  
Reversibles Mulchgerät  
Trinciatrice reversibile

HP  
50 - 120

kW

37 - 89

rpm

540 / 1000



ENG

The mulcher LEVANTE range is suitable to a heavy duty use on hard and uncultivated soils for professional users. Its honeycomb structure with high thickness allows to cut bushes, prunings of big diameter getting excellent results.

FRA

La gamme de broyeurs LEVANTE a été étudiée pour des opérateurs professionnels, pour une utilisation intensive de terrains vagues et difficiles. Sa structure alvéolaire à grand épaisseur, lui permet de broyer gros buissons, élagages, sarments, pour des résultats exceptionnels.

DEU

Die Familie der Mulchgeräte LEVANTE wendet sich an professionelle Betreiber für den intensiven Einsatz in schwierigen und unkultivierten Gelände. Seine Wabenstruktur mit großer Stärke, erlaubt ihm Sträucher-Beschneidungen-Ranken von große Dicke zu beschneiden, zur Erhaltung von großen Produktionsergebnissen.

ITA

La famiglia di trinciatrici LEVANTE è rivolta ad operatori professionali per un utilizzo intensivo su terreni difficili ed incolti. La sua struttura alveolare a grande spessore gli consente di aggredire cespugli, potature, sarmenti anche di grosso calibro ottenendo grandi risultati produttivi.

## STANDARD FEATURES

- REVERSIBLE FRAME FOR FRONT OR REAR MOUNTING; FIXED OR HYDRAULIC SIDE SHIFT 3 POINT HITCH
- DUAL PTO SPEEDS: 540 AND 1000 RPM
- COUNTERBLADE DEVICE
- TRANSMISSION BY 4 HEAVY-DUTY BELTS
- HIGH THICKNESS SIDES (10 MM)
- WIDE DISCHARGE AREA
- ADJUSTABLE REAR LEVELLING ROLLER Ø 160 MM
- SKIDS KIT
- UNIVERSAL PTO SHAFT CATEGORY 6 - 1200 MM SITUATIONS

## CARACTÉRISTIQUES STANDARD

- CONFIGURABLE DE SÉRIE EN 4 VARIABLES D'ATTelage : ARRIÈRE, FRONTALE, FIXE OU AVEC DÉPORT HYDRAULIQUE
- CONFIGURABLE DE SÉRIE: 540 ET 1000 T/MIN
- CONTRE-COUTEAUX DE SÉRIE
- TRANSMISSION À 4 COURROIES
- CÔTÉS CHÂSSIS GRAND ÉPAISSEUR (10MM)
- GRANDE SURFACE DE DÉCHARGE, EXTENSIBLE
- KIT ROULEAU ARRIÈRE REGLABLE Ø160 MM
- KIT SURPATINS LATÉRAUX
- CARDAN STANDARD 6° CATÉGORIE - 1200 MM

## STANDARD EIGENSCHAFTEN

- SERIEN KONFIGURIERBAR IN 4 ANBAU OPTIONEN: FRONT- ODER HECKANBAU, FEST ODER HYDRAULISCH VERSCHIEBBAR
- SERIEN KONFIGURIERBAR: 540 UND 1000 U/MIN
- 4 RIEMEN ANTRIEB
- GEGEN-MESSER
- BREITES GESTELL AN DEN SEITEN (10MM)
- GROSSER ENTLASTUNG BEREICH, ERWEITERBAR
- VERSTELLBARE HINTERE NACHLAUFWALZE Ø 160 MM
- ZUSÄTZLICHER KUFEN KIT
- STANDARD GELENKWELLE KATEGORIE 6 - 1200 MM

## CARATTERISTICHE STANDARD

- CONFIGURABILE DI SERIE IN 4 VARIABILI DI ATTACCO: ANTERIORE, POSTERIORE, FISSO O SPOSTABILE IDRAULICAMENTE
- CONFIGURABILE DI SERIE: 540 E 1000 GIRI/MIN.
- TRASMISSIONE CON 4 CINGHIE
- DISPOSITIVO CONTRO COLTELLI DI SERIE
- FIANCHI TELAIO DI GRANDE SPESSORE (10MM)
- AMPIA AREA DI SCARICO, ESPANDIBILE
- KIT RULLO POSTERIORE REGOLABILE, 160 MM DI DIAMETRO
- KIT PATTINI DI USURA SUPPLEMENTARI
- CARDANO STANDARD 6° CATEGORIA - 1200 MM



**FIXED VERSION - VERSION FIXE - FESTE VERSION - VERSIONE FISSA**

COD-MOD	n.	hp	cm	in	cm	in	cm	in	n.	n.	cm	in	kg	lbs	€
LEV 140 F	4C	50 - 120	140	55	70	28	70	28	20	40	2-11	1-4	450	992	
LEV 160 F	4C	50 - 120	160	64	71	28	95	38	24	48	2-11	1-4	475	1047	
LEV 190 F	4C	50 - 120	188	75	75	30	117	47	28	56	2-11	1-4	502	1107	
LEV 220 F	4C	50 - 120	216	86	88	35	130	52	32	64	2-11	1-4	539	1188	
LEV 250 F	4C	80 - 120	245	98	101	40	143	57	36	72	2-11	1-4	600	1323	

**SIDE SHIFT VERSION - DEPORT LATERALE - VERSCHIBBARE VERSION - VERSIONE SPOSTABILE**

COD-MOD	n.	hp	cm	in	cm	in	cm	in	cm	in	cm	in	n.	n.	cm	in	kg	lbs	€
LEV 140 H	4C	50 - 120	140	55	70	28	70	28	30	12	90	35	20	40	2-11	1-4	490	1080	
LEV 160 H	4C	50 - 120	160	64	83	33	83	34	43	17	123	48	24	48	2-11	1-4	524	1155	
LEV 190 H	4C	50 - 120	186	75	96	38	96	38	56	22	136	54	28	56	2-11	1-4	565	1246	
LEV 220 H	4C	50 - 120	216	86	109	44	109	44	69	28	149	60	32	64	2-11	1-4	600	1323	
LEV 250 H	4C	50 - 120	245	98	122	49	122	49	82	33	162	81	36	72	2-11	1-4	661	1457	

**Cod. OPTIONAL Type €**



**C**

Rotor with Y blades for universal use- grass  
 Rotor avec couteaux pour utilisation universelle - herbe  
 Rotor mit Y-Messer für den universellen Einsatz - Gras  
 Rotore con coltelli per uso universale - erba

- Levante 140 C
- Levante 160 C
- Levante 190 C
- Levante 220 C
- Levante 250 C

**Cod. OPTIONAL Type €**



**M**

Rotor with hammers for specific use- raw land, brambles, pruning  
 Rotor avec marteaux - terrains, ronces, élagages  
 Rotor mit Hammerschlegel - für vernachlässigter Boden und Gebüsche  
 Rotore con mazze - terreni incolti, rovi, potature

- Levante 140 M
- Levante 160 M
- Levante 190 M
- Levante 220 M
- Levante 250 M

**Cod. OPTIONAL €**

**TEND 1000**

Belt tensioner for change-over from 540 rpm to 1000 rpm  
 Tendeur version 1000 t/min  
 Riemenspanner Version 1000 U/min  
 Tendencinghia: Trasformazione da 540 g/min a 1000 g/min

**Cod. €**



**H**

Hydraulic kit for side-shift  
 Dispositif de déport hydraulique du troisième point  
 Hydraulische Verschiebung  
 Dispositivo di spostamento idraulico dell'attacco a tre punti

**DIMENSIONS - DIMENSIONS - ABMESSUNGEN - INGOMBRI**

Type	A (cm)	B (cm)	C (cm)
Levante 140	170	120	95
Levante 160	190	120	95
Levante 190	220	120	95

Type	A (cm)	B (cm)	C (cm)
Levante 220	250	120	95
Levante 250	280	120	95

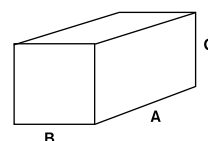

**PACKAGING - EMBALLAGE - VERPACKUNG - IMBALLAGGI**



- Single metal crate
- Caisse Métallique unitaire
- Einzelne Metall Palette
- Cassa singola



# Levante Plus

Reversible mulcher  
Broyeur reversible  
Reversibles Mulchge  
Trinciatrice reversibil

HP  
80 - 120

kW

60 - 89

rpm

540 / 1000



ENG

The mulcher LEVANTE range is suitable to a heavy duty use on hard and uncultivated soils for professional users. Its honeycomb structure with high thickness allows to cut bushes, prunings of big diameter getting excellent results.

FRA

La gamme de broyeurs LEVANTE a été étudiée pour des opérateurs professionnels, pour une utilisation intensive de terrains vagues et difficiles. Sa structure alvéolaire à grand épaisseur, lui permet de broyer gros buissons, élagages, sarments, pour des résultats exceptionnels.

DEU

Die Familie der Mulchgeräte LEVANTE wendet sich an professionelle Betreiber für den intensiven Einsatz in schwierigen und unkultivierten Gelände. Seine Wabenstruktur mit großer Stärke, erlaubt ihm Sträucher-Beschneidungen-Ranken von große Dicke zu beschneiden, zur Erhaltung von großen Produktionsergebnissen.

ITA

La famiglia di trinciatrici LEVANTE è rivolta ad operatori professionali per un utilizzo intensivo su terreni difficili ed incolti. La sua struttura alveolare a grande spessore gli consente di aggredire cespugli, potature, sarmenti anche di grosso calibro ottenendo grandi risultati produttivi.

## STANDARD FEATURES

- REINFORCED FRAME
- HYDRAULIC SHIFT
- REVERSIBLE FRAME FOR FRONT OR REAR MOUNTING
- DUAL PTO SPEEDS: 540 AND 1000 RPM
- COUNTERBLADE DEVICE
- TRANSMISSION BY 4 HEAVY-DUTY BELTS
- HIGH THICKNESS SIDES (10 MM)
- WIDE DISCHARGE AREA
- ADJUSTABLE REAR LEVELLING ROLLER Ø 160 MM
- SKIDS KIT
- UNIVERSAL PTO SHAFT CATEGORY 6 - 1200 MM SITUATIONS

## CARACTÉRISTIQUES STANDARD

- CHÂSSIS RENFORCÉ
- DÉPORT HYDRAULIQUE DE SERIE
- CONFIGURABLE DE SÉRIE EN 2 VARIABLES D'ATTelage : ARRIÈRE OU FRONTALE
- CONFIGURABLE DE SÉRIE: 540 ET 1000 T/MIN
- CONTRE-COUTEAUX DE SÉRIE
- TRANSMISSION À 4 COURROIES
- CÔTÉS CHÂSSIS GRAND ÉPAISSEUR (10MM)
- GRANDE SURFACE DE DÉCHARGE, EXTENSIBLE
- KIT ROULEAU ARRIÈRE REGLABLE Ø160 MM
- KIT SURPATINS LATÉRAUX
- CARDAN STANDARD 6° CATÉGORIE - 1200 MM

## STANDARD EIGENSCHAFTEN

- VERSTÄRKTER RAHMEN
- HYDRAULISCHE VERSCHIEBUNG
- SERIEN KONFIGURIERBAR IN 2 ANBAU OPTIONEN: FRONT- ODER HECKANBAU
- SERIEN KONFIGURIERBAR: 540 UND 1000 U/MIN
- 4 RIEMEN ANTRIEB
- GEGEN-MESSER
- BREITES GESTELL AN DEN SEITEN (10MM)
- GROSSER ENTLASTUNG BEREICH, ERWEITERBAR
- VERSTELLBARE HINTERE NACHLAUFWALZE Ø 160 MM
- ZUSÄTZLICHER KUFEN KIT
- STANDARD GELENKWELLE KATEGORIE 6 - 1200 MM

## CARATTERISTICHE STANDARD

- TELAIO RINFORZATO
- SPOSTAMENTO IDRAULICO DI SERIE
- CONFIGURABILE DI SERIE IN 2 VARIABILI DI ATTACCO: ANTERIORE, POSTERIORE,
- CONFIGURABILE DI SERIE: 540 E 1000 GIRI/MIN.
- TRASMISSIONE CON 4 CINGHIE
- DISPOSITIVO CONTRO COLTELLI DI SERIE
- FIANCHI TELAIO DI GRANDE SPESSORE (10MM)
- AMPIA AREA DI SCARICO, ESPANDIBILE
- KIT RULLO POSTERIORE REGOLABILE, 160 MM DI DIAMETRO
- KIT PATTINI DI USURA SUPPLEMENTARI
- CARDANO STANDARD 6° CATEGORIA - 1200 MM



**SIDE SHIFT VERSION - DEPORT LATERALE - VERSCHIBBARE VERSION - VERSIONE SPOSTABILE**

COD-MOD	n.	hp	cm	in	cm	in	cm	in	cm	in	cm	in	n.	n.	cm	in	kg	lbs	€
<b>LEV PLUS 250 H</b>	<b>4C</b>	80 - 120	245	98	122	49	122	49	82	33	162	81	36	72	2-11	1-4	736	1622	
<b>LEV PLUS 270 H</b>	<b>4C</b>	80 - 120	270	106	122	49	122	49	82	33	162	81	40	80	2-11	1-4	770	1698	

Cod.	OPTIONAL	Type	€
------	----------	------	---



**C**

*Rotor with Y blades for universal use- grass  
Rotor avec couteaux pour utilisation universelle - herbe  
Rotor mit Y-Messer für den universellen Einsatz - Gras  
Rotore con coltelli per uso universale - erba*

Levante Plus 250 C

Levante Plus 270 C

Cod.	OPTIONAL	Type	€
------	----------	------	---



**M**

*Rotor with hammers for specific use- raw land, brambles, pruning  
Rotor avec marteaux - terrains, ronces, élagages  
Rotor mit Hammerschlegel - für vernachlässigter Boden und Gebüsche  
Rotore con mazze - terreni incolti, rovi, potature*

Levante Plus 250 M

Levante Plus 270 M

Cod.	OPTIONAL	Type	€
------	----------	------	---

**TEND 1000**

*Belt tensioner for change-over from 540 rpm to 1000 rpm  
Tendeur version 1000 t/min  
Riemenspanner Version 1000 U/min  
Tendicinghia: Trasformazione da 540 g/min a 1000 g/min*

Cod.	OPTIONAL	Type	€
------	----------	------	---



**H**

*Hydraulic kit for side-shift  
Dispositif de déport hydraulique du troisième point  
Hydraulische Verschiebung  
Dispositivo di spostamento idraulico dell'attacco a tre punti*

**DIMENSIONS - DIMENSIONS - ABMESSUNGEN - INGOMBRI**

Type	A (cm)	B (cm)	C (cm)
LEV PLUS 250	280	120	95
LEV PLUS 270	300	120	95

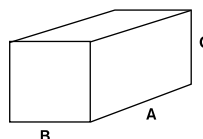

**PACKAGING - EMBALLAGE - VERPACKUNG - IMBALLAGGI**



- Single metal crate
- Caisse Métallique unitaire
- Einzelne Metall Palette
- Cassa singola

# Victor

**Reversible mulcher**  
**Broyeur réversible**  
**Reversibles Mulchgerät**  
**Trinciatrice reversibile**

**HP**  
**50 - 120**

kW

40 - 90

rpm

540 / 1000

 cm 2-7 - inch 1-3



ENG

A professional mulcher for the demanding farmer with 4-belt drive and suitable for medium to high horse power tractors. Multipurpose, side shift and reversible mounting.

FRA

Machine professionnelle indiquée pour les agriculteurs exigeantes, avec transmission par 4 courroies. Elle est destinée aux tracteurs de moyennes et grandes puissances. Etant réversible et déportable elle est dotée d'une grande polyvalence.

DEU

Ein professioneller Schlegelmulcher für den anspruchsvollen Bauern. Mit 4 Keilriemen, für Traktoren von mittel bis hohe PS geeignet. Vielseitig mit Seitenverschiebung und reversiblen Anbau.

ITA

Macchina professionale che si rivolge ad agricoltori e contoterzisti esigenti. È adatta ad un trattore di medie e grandi potenze. Polivalente, con 4 cinghie di trasmissione, reversibile, spostabile e con ramponi posteriori.

## STANDARD FEATURES

- REVERSIBLE, HYDRAULIC SIDE SHIFT, 3 POINT HITCH, CATEGORY 2
- CAST IRON GEAR BOX WITH INTEGRATED FREE WHEEL DEVICE AND PASS THROUGH SHAFT
- 4 BELT TRANSMISSION, VENTILATED WITH ADJUSTABLE TENSIONER
- ROTOR WITH HAMMERS OR BLADES
- ADJUSTABLE REAR ROLLER
- ADJUSTABLE SKIDS
- REAR CRAMPONS
- UNIVERSAL PTO SHAFT CATEGORY 6 - 900 MM

## CARACTÉRISTIQUES STANDARD

- ATTELAGE À 3 POINTS, CATÉGORIE 2, RÉVERSIBLE, DEPORTABLE HYDRAULIQUEMENT
- BOITIER EN FONTE 540 T/MIN AVEC ROUE LIBRE ET ARBRE PASSANT
- TRANSMISSION PAR 4 COURROIES VENTILÉES AVEC TENDEUR À VIS RÉGLABLE
- ROTOR AVEC COUTEAUX OU MARTEAUX
- ROULEAU ARRIÈRE RÉGLABLE
- PATINS RÉGLABLES
- CRAMPONS POSTÉRIEURS
- CARDAN UNIVERSEL CATÉGORIE 6 - 900 MM

## STANDARD EIGENSCHAFTEN

- DREIPUNKTBOCK KATEGORIE 2 HYDRAULIK SEITEN VERSCHIEBBAR UND REVERSIBEL
- GUSSEISENEN GETRIEBE 540 U/MIN MIT FREILAUF UND DOPPELTE EINGANGSWELLE
- ANTRIEB MIT 4 KEILRIEMEN MIT LÜFTUNG UND SCHRAUBENSANNER
- ROTOR MIT Y-MESSER ODER HAMMERSCHLEGEL
- VERSTELLBARE NACHLAUFWALZE
- VERSTELLBARE KUFEN.
- HECK STEIGEISEN
- STANDARD GELENKWELLE KATEGORIE 6 - 900 MM

## CARATTERISTICHE STANDARD

- ATTACCO A 3 PUNTI CATEGORIA 2 REVERSIBILE E SPOSTABILE IDRAULICAMENTE
- RIDUTTORE IN GHISA 540 G/MIN CON RUOTA LIBERA INTEGRATA E ALBERO PASSANTE
- TRASMISSIONE CON 4 CINGHIE CON TENDITORE A VITE REGISTRABILE
- ROTORE CON COLTELLI O MAZZE
- RULLO POSTERIORE REGOLABILE
- SLITTE REGOLABILI
- RAMPONI POSTERIORI
- CARDANO UNIVERSALE CATEGORIA 6 - 900 MM



COD-MOD	n.	hp							kg	lbs	€
			cm	in	cm	in	n.	n.			
<b>Victor 150</b>	<b>4C</b>	<b>50 - 120</b>	<b>144</b>	<b>58"</b>	<b>175</b>	<b>70"</b>	<b>28</b>	<b>14</b>	<b>595</b>	<b>1312</b>	
<b>Victor 170</b>	<b>4C</b>	<b>50 - 120</b>	<b>164</b>	<b>66"</b>	<b>195</b>	<b>78"</b>	<b>32</b>	<b>16</b>	<b>615</b>	<b>1356</b>	
<b>Victor 190</b>	<b>4C</b>	<b>50 - 120</b>	<b>184</b>	<b>74"</b>	<b>215</b>	<b>86"</b>	<b>36</b>	<b>18</b>	<b>719</b>	<b>1585</b>	
<b>Victor 210</b>	<b>4C</b>	<b>50 - 120</b>	<b>204</b>	<b>82"</b>	<b>235</b>	<b>94"</b>	<b>40</b>	<b>20</b>	<b>756</b>	<b>1667</b>	
<b>Victor 230</b>	<b>4C</b>	<b>80 - 120</b>	<b>224</b>	<b>90"</b>	<b>255</b>	<b>102"</b>	<b>44</b>	<b>22</b>	<b>814</b>	<b>1795</b>	
<b>Victor 250</b>	<b>4C</b>	<b>80 - 120</b>	<b>244</b>	<b>98"</b>	<b>275</b>	<b>110"</b>	<b>48</b>	<b>24</b>	<b>850</b>	<b>1874</b>	
<b>Victor 270</b>	<b>4C</b>	<b>80 - 120</b>	<b>264</b>	<b>106"</b>	<b>295</b>	<b>118"</b>	<b>52</b>	<b>26</b>	<b>889</b>	<b>1960</b>	

Cod.	OPTIONAL	Type	€
	<b>C</b>	Victor 150 C	
		Victor 170 C	
		Victor 190 C	
		Victor 210 C	
		Victor 230 C	
		Victor 250 C	
		Victor 270 C	
		<i>Rotor with Y blades for universal use- grass</i> <i>Rotor avec couteaux pour utilisation universelle - herbe</i> <i>Rotor mit Y-Messer für den universellen Einsatz - Gras</i> <i>Rotore con coltelli per uso universale - erba</i>	

Cod.	OPTIONAL	Type	€
	<b>M</b>	Victor 150 M	
		Victor 170 M	
		Victor 190 M	
		Victor 210 M	
		Victor 230 M	
		Victor 250 M	
		Victor 270 M	
		<i>Rotor with hammers for specific use- raw land, brambles, pruning</i> <i>Rotor avec marteaux - terrains, ronces, élagages.</i> <i>Rotor mit Hammerschlegel - für vernachlässigter Boden und Gebüsche</i> <i>Rotore con mazze - terreni incolti, rovi, potature</i>	

Cod.	OPTIONAL	Type	€
		<b>R1</b>	
		<i>Gear box 1000 RPM</i> <i>Boîtier pour PDF à 1000 tours</i> <i>Getriebe mit 1000 U/min</i> <i>Riduttori per PDF a 1000 RPM</i>	

**DIMENSIONS - DIMENSIONS - ABMESSUNGEN - INGOMBRI**

Type	A (cm)	B (cm)	C (cm)
Victor 150	180	110	120
Victor 170	200	110	120
Victor 190	220	110	120
Victor 210	240	110	120
Victor 230	260	110	120
Victor 250	280	110	120
Victor 270	300	110	120

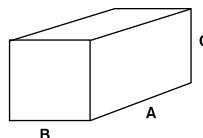

**PACKAGING - EMBALLAGE - VERPACKUNG - IMBALLAGGI**



- Single metal crate
- Caisse Métallique unitaire
- Einzelne Metall Palette
- Cassa singola

# DMK

Rotary slasher  
Gyrobroyeur  
Kreiselmulchgerät  
Girotrincia

HP  
15 - 80

kW

12 - 60

rpm

540



cm 3-10 - inch 1-4

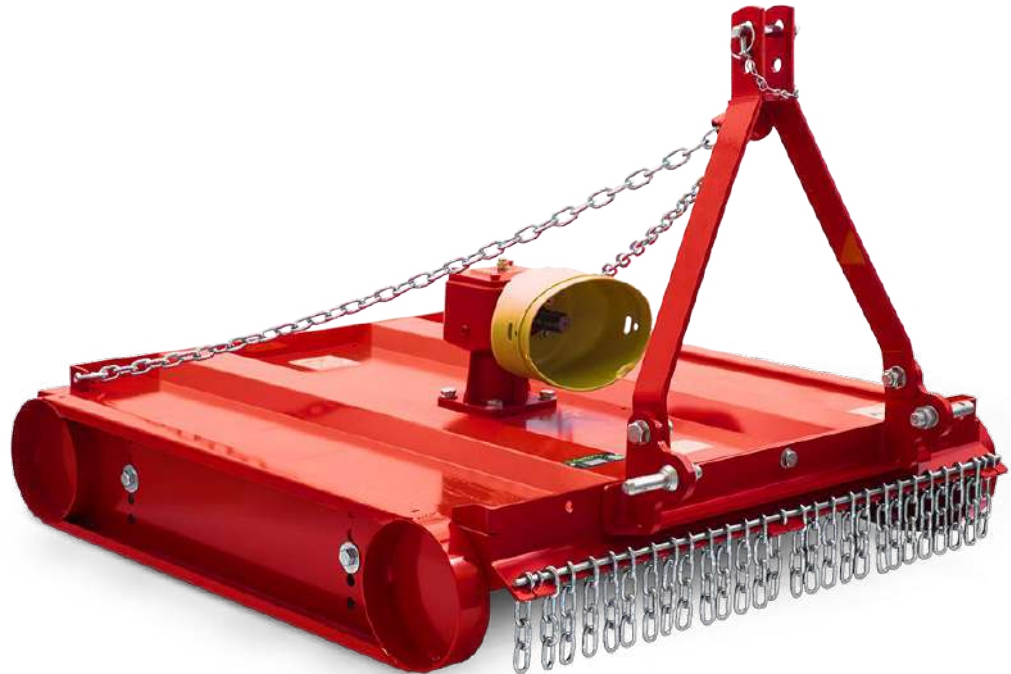

ENG

Simple and efficient rotary slasher with good performance and very economic to purchase and maintain.

FRA

Il s'agit d'une machine simple et efficace, qui unit performances et économie dans le prix et l'entretien.

DEU

Einfacher und Leistungsfähiger Kreiselmulchgerät mit guter Arbeitsleistung, günstig im Preis und in der Wartung.

ITA

Macchina semplice ed efficace, unisce performance operative ed economicità sia nel prezzo che nella manutenzione.

## STANDARD FEATURES

- 3 POINT HITCH, CATEGORY 1 (DMK 90-135) AND 2 (DMK 150-180)
- CAST IRON GEARBOX 540 RPM
- DIRECT DRIVE
- ROTOR WITH 2 OR 3 SWINGING BLADES
- HINGED REAR FLAP FACILITATES GRASS EXPULSION
- REVERSIBLE AND ADJUSTABLE SKIDS
- FRONTAL CHAINS FOR PROTECTION
- UNIVERSAL PTO SHAFT:  
2° CAT. B - 900 MM FOR DMK 90-100,  
2° CAT. B - 1100 MM FOR DMK 110-120,  
4° CAT. B - 1200 MM FOR DMK 135  
4° CAT. F - 1200 MM FOR DMK 150/2, 150/3  
5° CAT. F - 1200 MM FOR DMK 180/3,

## CARACTÉRISTIQUES STANDARD





- ATTELAGE À 3 POINTS 1° CATÉGORIE (DMK 90-135) ET 2 (DMK 150-180)
- BOITIER EN FONTE 540 T/MIN
- TRANSMISSION DIRECTE
- ROTOR AVEC 2 OU 3 LAMES ESCAMOTABLES
- PROTECTION ARRIÈRE
- PATINS RÉGLABLES ET RÉVERSIBLES
- PROTECTION AVANT PAR CHAÎNES
- CARDAN:  
2° CAT. B - 900 MM POUR DMK 90-100,  
2° CAT. B - 1100 MM POUR DMK 110-120,  
4° CAT. B - 1200 MM POUR DMK 135  
4° CAT. F - 1200 MM POUR DMK 150/2, 150/3  
5° CAT. F - 1200 MM POUR DMK 180/3,

## STANDARD EIGENSCHAFTEN

- SEITENVERSCHIEBBARER DREIPUNKT-BOCK KATEGORIE 1 (DMK 90-135) UND 2 (DMK 150-180)
- GUSSEISENES GETRIEBE 540 U/MIN
- DIREKT ANTRIEB
- ROTOR MIT 2 ODER 3 SCHWINKENDEN MESSERN
- BEWEGLICHER BLECHSTREIFEN
- VERSTELLBARE UND UMKEHRBARE KUFEN
- VORDER AUSWURFSCHUTZ MIT KETTEN
- GELENKWELLE:  
2° CAT. B - 900 MM FÜR DMK 90-100,  
2° CAT. B - 1100 MM FÜR DMK 110-120,  
4° CAT. B - 1200 MM FÜR DMK 135  
4° CAT. F - 1200 MM FÜR DMK 150/2, 150/3  
5° CAT. F - 1200 MM FÜR DMK 180/3,

## CARATTERISTICHE STANDARD

- ATTACCO A 3 PUNTI 1° CATEGORIA (DMK 90-135) E 2° CATEGORIA (DMK 150-180)
- RIDUTTORE IN GHISA 540 G/MIN.
- TRASMISSIONE DIRETTA
- ROTORE CON 2 O 3 LAME SNODATE
- BANDELLA POSTERIORE
- SLITTE REGOLABILI E REVERSIBILI
- PROTEZIONE ANTERIORE CON CATENE
- GIUNTO CARDANICO:  
2° CAT. B - 900 MM PER DMK 90-100,  
2° CAT. B - 1100 MM PER DMK 110-120,  
4° CAT. B - 1200 MM PER DMK 135  
4° CAT. F - 1200 MM PER DMK 150/2, 150/3  
5° CAT. F - 1200 MM PER DMK 180/3,

COD-MOD	hp								€
		cm	in	cm	in				
<b>DMK 90</b>	15 - 40	90	35"	105	42"	2	130	287	
<b>DMK 100</b>	15 - 40	100	40"	115	46"	2	143	315	
<b>DMK 110</b>	15 - 40	110	44"	125	50"	2	160	353	
<b>DMK 120</b>	15 - 40	120	48"	135	54"	2	176	388	
<b>DMK 135</b>	15 - 40	135	53"	150	60"	2	198	437	
<b>DMK 150/2</b>	15 - 40	150	60"	165	66"	2	235	518	
<b>DMK 150/3</b>	30 - 80	150	60"	165	66"	3	260	573	
<b>DMK 180/3</b>	30 - 80	180	72"	195	78"	3	346	763	

**DIMENSIONS - DIMENSIONS - ABMESSUNGEN - INGOMBRI**

Type	A (cm)	B (cm)	C (cm)
DMK 90	120	110	55
DMK 100	130	120	55
DMK 110	140	130	55
DMK 120	150	140	55
DMK 135	170	160	55
DMK 150/2	180	170	55
DMK 150/3	180	170	65
DMK 180/3	210	200	65

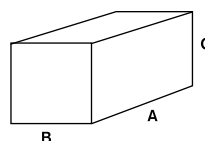

**PACKAGING - EMBALLAGE - VERPACKUNG - IMBALLAGGI**



- Single metal crate
- Caisse Métallique unitaire
- Einzelne Metall Palette
- Cassa singola







**Offset flail mowers**  
**Broyeurs d'accotement**  
**Seitenmulcher**  
**Trinciatrici laterali**



**Funny  
Super**

15 - 35 HP

106 / 132

84 85



**Centurion  
Super**

15 - 60 HP

106 / 132 / 158

86 87



**Flipper  
Super**

50 - 80 HP

132 / 158 / 186

88 89



**Levante  
Super**

80 - 120 HP

160 / 190 / 220

90 91

# Funny Super

Offset flail mower  
 Broyeur d'accotement  
 Seitenmulcher  
 Trinciatrice laterale

HP  
 15 - 35

kW  
 12 - 25

rpm  
 540

 cm 5,5-13,5 - inch 2-5



ENG

This offset flail mower has a flexible arm and can mow embankments and close to or under trees and bushes. It is designed for semi-professional use and works well with low HP tractors as it is light and flexible. It can be used to cut grass, weeds and small bushes.

FRA

Ce broyeur est indiqué pour des tracteurs de petite et moyenne puissance et pour une utilisation semi professionnelle. Le déport hydraulique latéral permet de passer sous le feuillage des plantations en lignes. Cette machine se caractérise pour sa maniabilité et sa polyvalence à couper herbe, arbustes etc..

DEU

Dieser Schlegelmulcher hat ein beweglicher Arm und kann als Böschungmäher eingesetzt werden und kann auch unter Bäumen oder Büsche arbeiten. Es ist für einen semi-professioneller Einsatz konzipiert und passt gut zu Traktoren mit geringen PS da es leicht und elastisch ist. Es kann benutzt werden um Rasen, Gras und kleine Büsche zu mulchen.

ITA

Trinciatrice laterale indicata per piccole e medie potenze per un utilizzo semi professionale; lo spostamento laterale consente di entrare sotto la chioma di piante e frutteti. Si caratterizza per la sua elasticità unita alla capacità di taglio di erba e piccoli arbusti.

## STANDARD FEATURES

- 3 POINT HITCH, CATEGORY 1 AND 2, HYDRAULIC SIDE SHIFT AND ROTATION
- ALUMINUM GEARBOX 540 RPM WITH INTEGRATED FREE WHEEL DEVICE
- TWO BELT TRANSMISSION WITH ADJUSTABLE TENSIONER
- ROTOR WITH "Y" BLADES OR HAMMERS
- ADJUSTABLE AND EXTENDABLE REAR ROLLER
- UNIVERSAL PTO SHAFT CATEGORY 4 - 1470 MM

## CARACTÉRISTIQUES STANDARD

- ATTELAGE À 3 POINTS 1° ET 2° CATÉGORIE, DEPORTABLE ET ROTATION HYDRAULIQUE
- BOITIER EN ALUMINIUM 540 T/MIN AVEC ROUE LIBRE INTÉGRÉE
- TRANSMISSION AVEC DEUX COURROIES VENTILÉES AVEC TENDEUR À VIS RÉGLABLE
- ROTOR AVEC COUTEAUX OU MARTEAUX
- ROULEAU ARRIÈRE RÉGLABLE ET EXTENSIBLE
- CARDAN STANDARD 4° CATÉGORIE - 1470 MM

## STANDARD EIGENSCHAFTEN

- DREIPUNKTBOCK-ANSCHLUß KATEGORIE 1 UND 2 MIT HYDRAULISCHER VERSCHIEBUNG UND ROTATION
- ALUMINIUM-GETRIEBE 540 U/MIN MIT FREILAUF
- ANTRIEB MIT 2 KEILRIEMEN UND EINSTELLBAREM SCHRAUBENSPELLER
- ROTOR MIT Y-MESSER ODER-HÄMMERSCHLEGEL
- VERSTELLBARE UND VERLÄNGERBARE NACHLAUFWALZE
- STANDARD GELENKWELLE KATEGORIE 4 - 1470 MM

## CARATTERISTICHE STANDARD

- ATTACCO A 3 PUNTI 1° E 2° CATEGORIA ROTAZIONE E SPOSTAMENTO LATERALE IDRAULICI
- RIDUTTORE IN ALLUMINIO 540 G/MIN CON RUOTA LIBERA
- TRASMISSIONE CON DUE CINGHIE CON TENDITORE A VITE REGISTRABILE
- ROTORE CON COLTELLI O MAZZE
- RULLO POSTERIORE REGOLABILE ED ESTENSIBILE
- CARDANO STANDARD 4° CATEGORIA - 1470 MM



COD-MOD	N.	hp	cm	in	cm	in	n.	n.	kg	lbs	€
Funny Super 106	2C	15 - 35	106	42"	120	48"	32	16	245	540	
Funny Super 132	2C	15 - 35	132	52"	155	62"	40	20	260	573	

Cod.	OPTIONAL	Type	€
------	----------	------	---



**C**

Rotor with Y blades for universal use- grass  
 Rotor avec couteaux pour utilisation universelle - herbe  
 Rotor mit Y-Messer für den universellen Einsatz - Gras  
 Rotore con coltelli per uso universale - erba

Funny Super 106 C

Funny Super 132 C

Cod.	Type	€
------	------	---



**M**

Rotor with hammers for specific use- raw land, brambles, pruning  
 Rotor avec marteaux - terrains, ronces, élagages  
 Rotor mit Hammerschlegel - für vernachlässigter Boden und Gebüsche  
 Rotore con mazze - terreni incolti, rovi, potature

Funny Super 106 M

Funny Super 132 M

Cod.	Type	€
------	------	---



**ER**

Extension Kit for rear roller  
 Kit rouleau arrière- Grande Ejection  
 Hintere Walze Verlängerungs kit  
 Kit prolunga rullo posteriore

Funny Super 80

Funny Super 93

Funny Super 106

Funny Super 132

Funny Super 158

cm	106	132
A	57	57
B	97	123
C	154	180
D	130	130
E	187	213
F	100	100

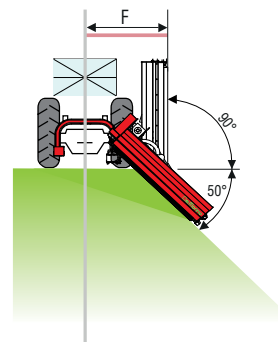
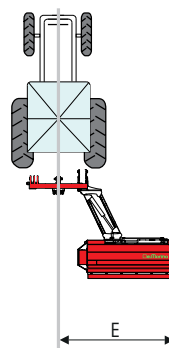
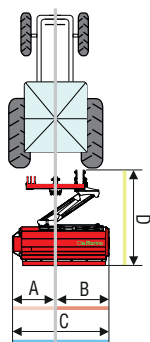

**DIMENSIONS - DIMENSIONS - ABMESSUNGEN - INGOMBRI**

Type	A (cm)	B (cm)	C (cm)
Funny Super 106	150	120	80
Funny Super 132	150	150	80

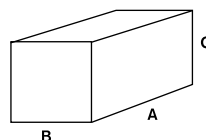

# Centurion Super

Offset flail mower  
Broyeur d'accotement  
Seitenmulcher  
Trinciatrice laterale

HP  
15 - 60

kW

11 - 45

rpm

540



cm 1-8 - inch 0,5-3



ENG

A practical, multipurpose flail mower for the professional farmer with a flexible arm for mowing embankments, etc. The power transmission system is the best available and is suitable for tractors up to 60 HP. The quality, performance and price are outstanding.

FRA

Polyvalent et pratique pour l'utilisateur professionnel, cette machine offre au client une technologie la plus avancée par rapport à ce qui existe aujourd'hui. Le CENTURION SUPER peut équiper des tracteurs d'une puissance de 60 HP maximum. Produit sûr et avec un excellent rapport qualité-prix.

DEU

Ein praktischer, vielseitiger Schlegelmulcher für den Profi mit beweglicher Arm so dass es als Böschungmäher eingestzt werden kann. Das Getriebe ist technisch auf den letzten Stand und ist für Traktoren bis 60 PS geeignet. Der Preis/Leistungs Verhältnis und die Qualität sind ausserordentlich.

ITA

Polivalente e pratico per l'agricoltore professionista, CENTURION SUPER racchiude nei suoi cinematismi quanto di meglio possa offrire la più recente tecnologia delle trasmissioni. Può essere applicata a trattori di potenza fino a 60 HP. Affidabile, di qualità ed economico.

## STANDARD FEATURES

- 3 POINT HITCH CATEGORY 1 AND 2, WITH HYDRAULIC SIDE SHIFT AND ROTATION
- CAST IRON GEAR BOX 540 RPM WITH INTEGRATED FREE WHEEL DEVICE
- 3 BELT DRIVE TRANSMISSION WITH SCREW ADJUSTABLE TENSIONER
- ROTOR WITH BLADES OR HAMMERS
- ADJUSTABLE REAR ROLLER
- UNIVERSAL PTO SHAFT CATEGORY 4 - 1470 MM

## CARACTÉRISTIQUES STANDARD

- ATTELAGE À 3 POINTS 1° ET 2° CATÉGORIE, DÉPORT ET ROTATION HYDRAULIQUES
- BOITIER EN FONTE 540 T/MIN AVEC ROUE LIBRE INTERGRÉE
- TRANSMISSION PAR 3 COURROIES VENTILÉES PAR TENDEUR À VIS RÉGLABLE
- ROTOR AVEC COUTEAUX OU MARTEAUX
- ROULEAU ARRIÈRE RÉGLABLE
- CARDAN STANDARD 4° CATÉGORIE - 1470 MM

## STANDARD EIGENSCHAFTEN

- DREIPUNKTBOCK-ANSCHLUß KATEGORIE 1 UND 2 MIT HYDRAULISCHER VERSCHILBUNG UND ROTATION
- GUSSEISENEN GETRIEBE 540 U/MIN MIT FREILAUF UND DOPPELTE EINGANGSWELLE
- ANTRIEB MIT 3 KEILRIEMEN UND EINSTELLBAREM SCHRAUBENSPELLER
- ROTOR MIT Y-MESSER ODER HÄMMERSCHLEGEL
- VERSTELLBARE NACHLAUFWALZE
- STANDARD GELENKWELLE KATEGORIE 4 - 1470 MM

## CARATTERISTICHE STANDARD

- ATTACCO A 3 PUNTI 1° E 2° CATEGORIA CON SPOSTAMENTO E ROTAZIONE IDRAULICI
- RIDUTTORE IN GHISA 540 G/MIN CON RUOTA LIBERA INTEGRATA
- TRASMISSIONE A 3 CINGHIE VENTILATE CON TENDITORE A VITE REGISTRABILE
- ROTORE A COLTELLI O A MAZZE
- RULLO POSTERIORE REGOLABILE
- CARDANO STANDARD 4° CATEGORIA - 1470 MM

COD-MOD	N.	hp	cm	in	cm	in	n.	n.	kg	lbs	€
<b>Centurion Super 106</b>	<b>3C</b>	<b>15 - 60</b>	<b>106</b>	<b>42"</b>	<b>120</b>	<b>50"</b>	<b>32</b>	<b>16</b>	<b>290</b>	<b>639</b>	
<b>Centurion Super 132</b>	<b>3C</b>	<b>15 - 60</b>	<b>132</b>	<b>52"</b>	<b>155</b>	<b>60"</b>	<b>40</b>	<b>20</b>	<b>350</b>	<b>772</b>	
<b>Centurion Super 158</b>	<b>3C</b>	<b>15 - 60</b>	<b>158</b>	<b>62"</b>	<b>195</b>	<b>72"</b>	<b>48</b>	<b>24</b>	<b>372</b>	<b>820</b>	

Cod.	OPTIONAL	Type	€
------	----------	------	---



**C**

*Rotor with Y blades for universal use- grass  
Rotor avec couteaux pour utilisation universelle - herbe  
Rotor mit Y-Messer für den universellen Einsatz - Gras  
Rotore con coltelli per uso universale - erba*

Centurion Super 106 C  
Centurion Super 132 C  
Centurion Super 158 C

Cod.	Type	€
------	------	---



**M**

*Rotor with hammers for specific use- raw land, brambles, pruning  
Rotor avec marteaux - terrains, ronces, élagages  
Rotor mit Hammerschlegel - für vernachlässigter Boden und Gebüsche  
Rotore con mazze - terreni incolti, rovi, potature*

Centurion Super 106 M  
Centurion Super 132 M  
Centurion Super 158 M

cm	106	132	158
A	60	60	60
B	95	121	147
C	155	181	207
D	148	148	148
E	188	214	240
F	100	100	100

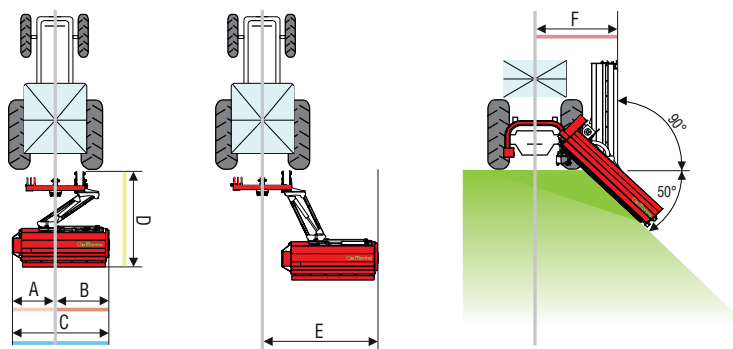

**DIMENSIONS - DIMENSIONS - ABMESSUNGEN - INGOMBRI**

Type	A (cm)	B (cm)	C (cm)
Centurion S. 106	<b>150</b>	<b>120</b>	<b>80</b>
Centurion S. 132	<b>150</b>	<b>150</b>	<b>80</b>
Centurion S. 158	<b>180</b>	<b>150</b>	<b>80</b>

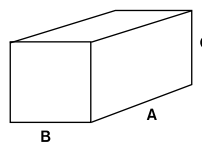



# Flipper Super

Offset flail mower  
Broyeur d'accotement  
Seitenmulcher  
Trinciatrice laterale

HP  
50 - 100

kW

40 - 60

rpm

540

 cm 1,5-10 - inch 0,5-4

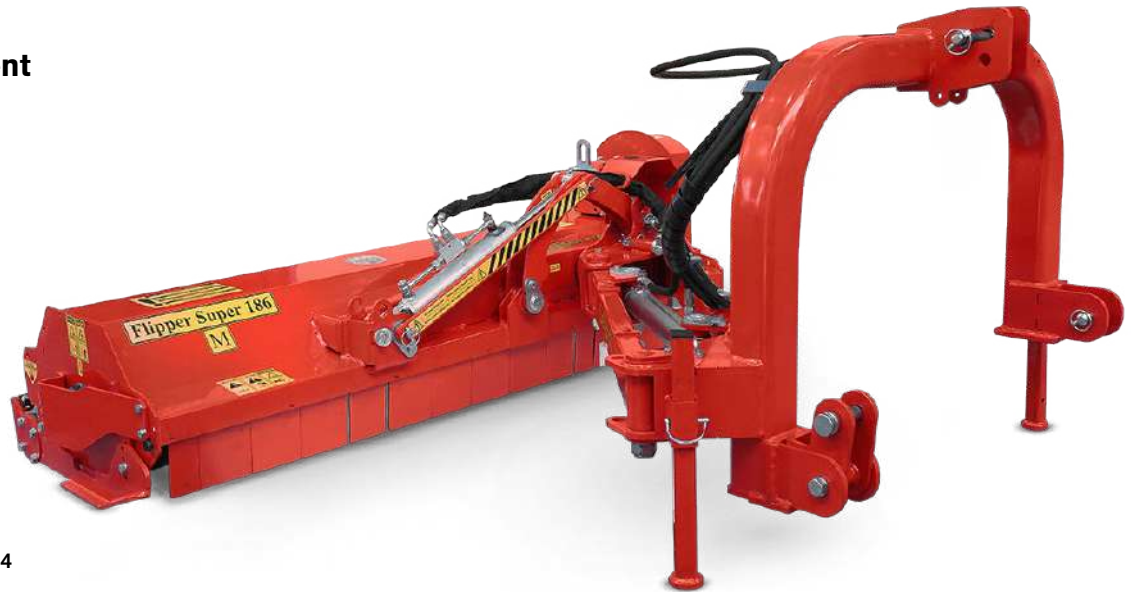

ENG

Suitable for professional, heavy, duty use. Strong, flexible and versatile. It permits an optimal maintenance of embankments, slopes, etc.

FRA

Idéal pour travaux professionnels pour une utilisation intensive. Costaute, élastique et flexible. Il permet un entretien optimale des terrains déclinantes, falaises et fossés.

DEU

Dieser Schlegelmulcher ist für professionelle Arbeiten bei intensiver Nutzung geeignet. Robust, elastisch und vielseitig. Er ermöglicht eine optimale Pflege von Hängen, Böschungen und Gräben.

ITA

Adatta a lavorazioni professionali per un utilizzo intensivo. Robusta, elastica e versatile. Consente una ottimale manutenzione di terreni declivi, scarpate e fossi.

## STANDARD FEATURES

- 3 POINT HITCH, CATEGORY 1 AND 2 WITH HYDRAULIC SIDE SHIFT
- CAST IRON GEARBOX 540 RPM WITH FREE WHEEL DEVICE
- COUNTERBLADE DEVICE
- REAR LEVELLING ROLLER Ø 160 MM
- HIGH THICKNESS SIDES 6MM
- UNIVERSAL PTO SHAFT CATEGORY 6 - 1800 MM

## CARACTÉRISTIQUES STANDARD

- ATTELAGE À 3 POINTS CATÉGORIE 1 ET 2, DÉPORT HYDRAULIQUE
- BOITIER EN FONTE 540 T/MIN AVEC ROUE LIBRE
- TRANSMISSION PAR 3 COURROIES PAR TENDEUR À VIS RÉGLABLE
- DISPOSITIF CONTRE COUTEAUX
- CÔTÉS CHÂSSIS ÉPAISSEUR 6MM
- ROULEAU D'APPUI DIAMÈTRE Ø 160 MM
- GRANDE SURFACE DE DÉCHARGE
- CARDAN STANDARD 6° CATÉGORIE - 1800 MM

## STANDARD EIGENSCHAFTEN

- DREIPUNKT ANSCHLUSS 1° UND 2° KATEGORIE MIT HYDRAULISCHER VERSCHIEBUNG
- GUSSEISENES GETRIEBE 540 U/MIN MIT FREILAUF
- ANTRIEB AUS 3 KEILRIEMEN MIT SCHRAUBENSANNER
- RAHMEN MIT GEGEN MESSER
- SEITENRAHMEN 6MM BREITE
- NACHLAUFWALZE Ø 160 MM
- GROSSER AUSWURF BEREICH
- STANDARD GELENKWELLE KATEGORIE 6 - 1800 MM

## CARATTERISTICHE STANDARD

- ATTACCO A 3 PUNTI 1° E 2° CATEGORIA CON SPOSTAMENTO E ROTAZIONE IDRAULICI
- RIDUTTORE IN GHISA 540 G/MIN CON RUOTA LIBERA
- TRASMISSIONE A 3 CINGHIE CON TENDITORE A VITE REGISTRABILE
- DISPOSITIVO CONTRO COLTELLI
- FIANCHI TELAIO SPESSORE 6 MM
- RULLO DI APPOGGIO Ø 160 MM
- AMPIA AREA DI SCARICO
- CARDANO STANDARD 6° CATEGORIA - 1800 MM

COD-MOD	N.	hp	cm		in		n.		kg	lbs	€
			cm	in	cm	in	n.	n.	kg	lbs	
<b>Flipper Super 132</b>	<b>3C</b>	<b>50 - 100</b>	<b>132</b>	<b>52"</b>	<b>158</b>	<b>62"</b>	<b>40</b>	<b>20</b>	<b>470</b>	<b>1036</b>	
<b>Flipper Super 158</b>	<b>3C</b>	<b>50 - 100</b>	<b>158</b>	<b>62"</b>	<b>184</b>	<b>72"</b>	<b>48</b>	<b>24</b>	<b>492</b>	<b>1085</b>	
<b>Flipper Super 186</b>	<b>3C</b>	<b>50 - 100</b>	<b>186</b>	<b>72"</b>	<b>210</b>	<b>82"</b>	<b>56</b>	<b>28</b>	<b>515</b>	<b>1135</b>	
<b>Flipper Super 214</b>	<b>3C</b>	<b>50 - 100</b>	<b>214</b>	<b>85"</b>	<b>230</b>	<b>92"</b>	<b>64</b>	<b>32</b>	<b>570</b>	<b>1256</b>	
Cod.		OPTIONAL									€



**C**

Rotor with Y blades for universal use- grass  
 Rotor avec couteaux pour utilisation universelle - herbe  
 Rotor mit Y-Messer für den universellen Einsatz - Gras  
 Rotore con coltelli per uso universale - erba

Cod.

€



**M**

Rotor with hammers for specific use- raw land, brambles, pruning  
 Rotor avec marteaux - terrains, ronces, élagages  
 Rotor mit Hammerschlegel - für vernachlässigter Boden und Gebüsche mit Stacheln  
 Rotore con mazze - terreni incolti, rovi, potature

Cod.

€

**4C**

4 belt kit  
 Kit 4 courroies  
 4 Riemen Kit  
 Kit 4 cinghie

Cod.

€



**S**

Skid Kit for heavy wear situations  
 Surpatins Latéraux  
 Zusätzlicher Kufen Kit  
 Kit pattini di usura supplementari

Cod.

€

**O**

Wide angle PTO shaft - closed curves  
 Cardan homocinétique - virages très serrés  
 Weitwinkelgelenkwelle - enge Kurven  
 Cardano omocinetico - curve strette

cm	132	158	186
A	76	76	76
B	82	108	134
C	158	184	210
D	210	210	210
E	198	224	250
F	134	134	134

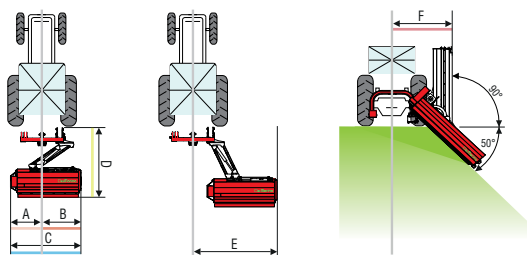

**DIMENSIONS - DIMENSIONS - ABMESSUNGEN - INGOMBRI**

Type	A (cm)	B (cm)	C (cm)
Flipper Super 132	160	120	200
Flipper Super 158	190	120	200
Flipper Super 186	220	120	200

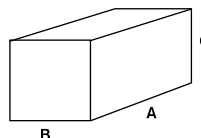

**PACKAGING - EMBALLAGE - VERPACKUNG - IMBALLAGGI**



- Single metal crate
- Caisse Métallique unitaire
- Einzelne Metall Palette
- Cassa singola

# Levante Super

Offset flail mower  
 Broyeur d'accotement  
 Seitenmulcher  
 Trinciatrice laterale

HP  
 80 - 140

kW

60 - 90

rpm

540 / 1000

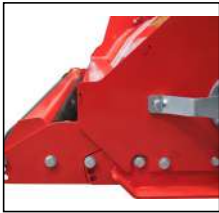

ENG

Suitable for professional, heavy duty use. Strong, flexible and versatile. It permits an optimal maintenance of embankments, slopes, etc.

FRA

Idéal pour travaux professionnels pour une utilisation intensive. Costeud, élastique et flexible. Il permet un entretien optimale des terrains déclinantes, falaises et fossés.

DEU

Dieser Schlegelmulcher ist für professionelle Arbeiten bei intensiver Nutzung geeignet. Robust, elastisch und vielseitig. Er ermöglicht eine optimale Pflege von Hängen, Böschungen und Gräben.

ITA

Adatta a lavorazioni professionali per un utilizzo intensivo. Robusta, elastica e versatile. Consente una ottimale manutenzione di terreni declivi, scarpate e fossi.

## STANDARD FEATURES

- 3 POINT HITCH, CATEGORY 2 AND 3 WITH HYDRAULIC SIDE SHIFT
- TRANSMISSION BY 4 HEAVY-DUTY BELTS
- COUNTERBLADE DEVICE
- HIGH THICKNESS SIDES (10 MM)
- COUNTERBLADE DEVICE
- REAR LEVELLING ROLLER Ø 160 MM
- WIDE DISCHARGE AREA
- UNIVERSAL PTO SHAFT CATEGORY 6 - 1800 MM

## CARACTÉRISTIQUES STANDARD

- ATTELAGE À 3 POINTS CATÉGORIE 2 ET 3, DÉPORT HYDRAULIQUE
- TRANSMISSION À 4 COURROIES
- CÔTÉS CHÂSSIS GRAND ÉPAISSEUR (10MM)
- DISPOSITIF CONTRE COUTEAUX
- ROULEAU D'APPUI DIAMÈTRE Ø160 MM
- GRANDE SURFACE DE DÉCHARGE, EXTENSIBLE
- CARDAN STANDARD 6° CATÉGORIE - 1800 MM

## STANDARD EIGENSCHAFTEN

- DREIPUNKT ANSCHLUSS 2° UND 3° KATEGORIE MIT HYDRAULISCHER VERSCHIEBUNG
- 4 RIEMEN AUSTATTUNG
- BREITES GESTELL AN DEN SEITEN (10MM)
- RAHMEN MIT GEGENMESSER
- NACHLAUFWALZE Ø 160 MM
- GROSSER ENTLASTUNG BEREICH, ERWEITERBAR
- STANDARD GELENKWELLE KATEGORIE 6 - 1800 MM

## CARATTERISTICHE STANDARD

- ATTACCO A 3 PUNTI 2° E 3° CATEGORIA CON SPOSTAMENTO E ROTAZIONE IDRAULICI
- TRASMISSIONE CON 4 CINGHIE
- DISPOSITIVO CONTRO COLTELLI DI SERIE
- FIANCHI TELAIO DI GRANDE SPESSORE (10MM)
- RULLO DI APPOGGIO Ø 160 MM
- AMPIA AREA DI SCARICO, ESPANDIBILE
- CARDANO STANDARD 6° CATEGORIA - 1800 MM



COD-MOD	n.	hp											€
			cm	in	cm	in	n.	n.	cm	in	kg	lbs	
<b>Levante Super 160</b>	<b>4C</b>	<b>80 - 140</b>	<b>160</b>	<b>63"</b>	<b>180</b>	<b>71"</b>	<b>48</b>	<b>24</b>	<b>2-11</b>	<b>1-4</b>	<b>720</b>	<b>1588</b>	
<b>Levante Super 190</b>	<b>4C</b>	<b>80 - 140</b>	<b>190</b>	<b>75"</b>	<b>208</b>	<b>82"</b>	<b>56</b>	<b>28</b>	<b>2-11</b>	<b>1-4</b>	<b>757</b>	<b>1669</b>	
<b>Levante Super 220</b>	<b>4C</b>	<b>80 - 140</b>	<b>220</b>	<b>87"</b>	<b>236</b>	<b>93"</b>	<b>64</b>	<b>32</b>	<b>2-11</b>	<b>1-4</b>	<b>795</b>	<b>1753</b>	

Cod.	OPTIONAL	€
------	----------	---



**C**

Rotor with Y blades for universal use- grass  
 Rotor avec couteaux pour utilisation universelle - herbe  
 Rotor mit Y-Messer für den universellen Einsatz - Gras  
 Rotore con coltelli per uso universale - erba

Cod.		€
------	--	---



**M**

Rotor with hammers for specific use- raw land, brambles, pruning  
 Rotor avec marteaux - terrains, ronces, élagages  
 Rotor mit Hammerschlegel - für vernachlässigter Boden und Gebüsche mit Stacheln  
 Rotore con mazze - terreni incolti, rovi, potature

Cod.		€
------	--	---



**ER**

Extension Kit for rear roller  
 Kit rouleau arrière- Grande Ejection  
 Hintere Walze Verlängerungs kit  
 Kit prolunga rullo posteriore

Cod.		€
------	--	---



**S**

Skid Kit for heavy wear situations  
 Surpatins Lateraux  
 Zusätzlicher Kufen Kit  
 Kit pattini di usura supplementari

Cod.		€
------	--	---

**O**

Wide angle PTO shaft - closed curves  
 Cardan homocinétique - virages très serrés  
 Weitwinkelgelenkwelle - enge Kurven  
 Cardano omocinetico - curve strette

cm	160	190	220
A	85	85	85
B	106	132	158
C	191	217	243
D	194	194	194
E	229	255	281
F	135	135	135

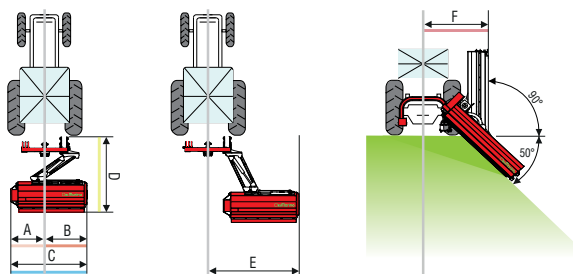

**DIMENSIONS - DIMENSIONS - ABMESSUNGEN - INGOMBRI**

Type	A (cm)	B (cm)	C (cm)
Levante Super 160	<b>190</b>	<b>120</b>	<b>200</b>
Levante Super 190	<b>220</b>	<b>120</b>	<b>200</b>
Levante Super 220	<b>250</b>	<b>120</b>	<b>200</b>

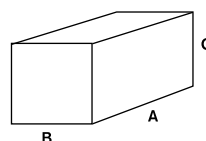

**PACKAGING - EMBALLAGE - VERPACKUNG - IMBALLAGGI**



- Single metal crate
- Caisse Métallique unitaire
- Einzelne Metall Palette
- Cassa singola



**Engine driven flail mowers**  
**Broyeurs à moteur**  
**Schlegelmulcher mit Verbrennungsmotor**  
**Trinciatrici a motore trainate**



**Centurion ATV**

---

**13 HP**

**132**

94	95
----	----



**Centurion ATV PRO**

---

**25 HP**

**158**

96	97
----	----



# Centurion ATV

**Engine driven flail mowers**  
**Broyeurs à moteur**  
**Schlegelmulcher mit Verbrennungsmotor**  
**Trinciatrici a motore trainate**

**HP**  
**13/14**

kW

10

 cm 3-10 - inch 1-4

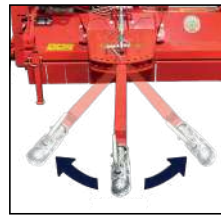
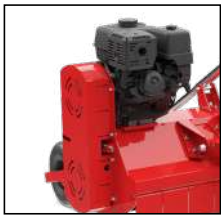
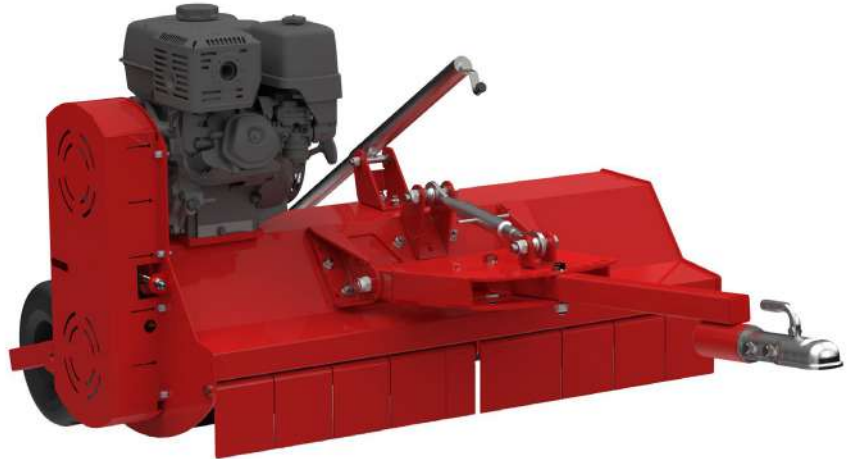

ENG

The Centurion ATV Flail Mower is designed to be towed by a QUAD, rider, or ATV. It can cut and mulch grass, weed and shrubs or, more simply, clear uncultivated fields.

FRA

Le broyeur CENTURION ATV est conçu pour être attelé à l'arrière de QUAD, Rider et ATV. Indiqué pour le broyage d'herbe ou d'arbustes ou, plus simplement, pour aérer le sol.

DEU

Der Centurion ATV-Mulcher ist die Ideale Maschine für den Einsatz mit QUADs, Riders und ATVs. Es kann benutzt werden um Rasen, Gras und Büsche zu mulchen.

ITA

La trincia Centurion ATV è ideata per l'applicazione posteriore su QUAD, Rider e Atv. Può essere impiegata per lavori di trinciatura di erba, arbusti o, più semplicemente, per arrieggiare il terreno.

## STANDARD FEATURES

- Ø 50 MM/2" BALL TYPE COUPLING
- HONDA GX390 / LONCIN G420 ENGINE
- 2 BELT DRIVE TRANSMISSION WITH SCREW ADJUSTABLE TENSIONER
- ROTOR WITH BLADES OR HAMMERS
- ADJUSTABLE REAR ROLLER
- MECHANIC SIDE SHIFT 56 CM
- CENTRIFUGAL CLUTCH
- FUEL TANK 6L (1,5 GAL)
- WHEEL POSITION ADJUSTABLE

## CARACTÉRISTIQUES STANDARD







- CROCHET D'ATTELAGE SPHÉRIQUE Ø 50 MM
- MOTEUR HONDA GX390/ LONCIN G420
- TRANSMISSION PAR 2 COURROIES VENTILÉES PAR TENDEUR À VIS
- ROTOR AVEC COUTEAUX OU MARTEAUX
- ROULEAU ARRIÈRE RÉGLABLE
- DÉPORT LATÉRAL MÉCANIQUE 56 CM
- EMBRAYAGE CENTRIFUGE
- RÉSERVOIR 6L
- POSITION RÉGLABLE DES ROUES



## STANDARD EIGENSCHAFTEN

- ANHÄNGERKUPPLUNG Ø 50 MM
- HONDA GX390 / LONCIN G420 MOTOR
- ANTRIEB MIT 2 KEILRIEMEN UND EINSTELLBAREM SCHRAUBENSANNER
- ROTOR MIT Y-MESSER ODER HAMMERSCHLEGEL
- EINSTELLBARE NACHLAUFWALZE
- SEITLICHE VERSCHIEBUNG 56MM NACH RECHTS ODER LINKS
- FRIZIONE CENTRIFUGA
- 6L-TANK
- EINSTELLBARE RÄDER

## CARATTERISTICHE STANDARD

- AGGANCIO A TESTINA SFERICA Ø 50 MM
- MOTORE HONDA GX390 / LONCIN G420
- TRASMISSIONE A 2 CINGHIE VENTILATE CON TENDITORE A VITE REGISTRABILE
- ROTORE A COLTELLI O A MAZZE
- RULLO POSTERIORE REGOLABILE
- SPOSTAMENTO LATERALE MECCANICO 56 CM
- FRIZIONE CENTRIFUGA
- SERBATOIO DA 6L (- POSIZIONE RUOTE REGOLABILE

COD-MOD	N.	hp												
			cm	in	cm	in	n.	n.	kg	lbs				
<b>ATV 120 - Honda</b>	<b>2C</b>	<b>13</b>	<b>119</b>	<b>47"</b>	<b>142</b>	<b>55"</b>	<b>40</b>	<b>20</b>	<b>270</b>	<b>594</b>				
<b>ATV 120 - Loncin</b>	<b>2C</b>	<b>14</b>	<b>119</b>	<b>47"</b>	<b>142</b>	<b>55"</b>	<b>40</b>	<b>20</b>	<b>270</b>	<b>594</b>				
<b>ATV 132 - Honda</b>	<b>2C</b>	<b>25</b>	<b>132</b>	<b>52"</b>	<b>150</b>	<b>60"</b>	<b>40</b>	<b>20</b>	<b>300</b>	<b>661</b>				
<b>ATV 132 - Loncin</b>	<b>2C</b>	<b>25</b>	<b>132</b>	<b>52"</b>	<b>150</b>	<b>60"</b>	<b>40</b>	<b>20</b>	<b>300</b>	<b>661</b>				

Cod.	OPTIONAL	Type
	<b>C</b> <i>Rotor with Y blades for universal use- grass</i> <i>Rotor avec couteaux pour utilisation universelle - herbe</i> <i>Rotor mit Y-Messer für den universellen Einsatz - Gras</i> <i>Rotore con coltelli per uso universale - erba</i>	Centurion ATV C
	<b>M</b> <i>Rotor with Y blades for universal use- grass</i> <i>Rotor avec couteaux pour utilisation universelle - herbe</i> <i>Rotor mit Y-Messer für den universellen Einsatz - Gras</i> <i>Rotore con coltelli per uso universale - erba</i>	Centurion ATV M

**DIMENSIONS - DIMENSIONS - ABMESSUNGEN - INGOMBRI**

Type	A (cm)	B (cm)	C (cm)
Centurion ATV	<b>170</b>	<b>120</b>	<b>95</b>

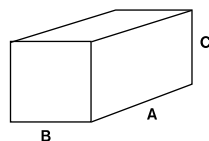

**PACKAGING - EMBALLAGE - VERPACKUNG - IMBALLAGGI**



- Single metal crate
- Caisse Métallique unitaire
- Einzelne Metall Palette
- Cassa singola

# Centurion ATV PRO

Engine driven flail mowers  
 Broyeurs à moteur  
 Schlegelmulcher mit Verbrennungsmotor  
 Trinciatrici a motore trainate

HP  
 25

kW

19



cm 3-10 - inch 1-4

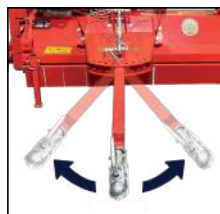

ENG

The Centurion ATV Flail Mower is designed to be towed by a QUAD, rider, or ATV. It can cut and mulch grass, weed and shrubs or, more simply, clear uncultivated fields.

FRA

Le broyeur CENTURION ATV est conçu pour être attelé à l'arrière de QUAD, Rider et ATV. Indiqué pour le broyage d'herbe ou d'arbustes ou, plus simplement, pour aérer le sol.

DEU

Der Centurion ATV-Mulcher ist die Ideale Maschine für den Einsatz mit QUADs, Riders und ATVs. Es kann benutzt werden um Rasen, Gras und Büsche zu mulchen.

ITA

La trincia Centurion ATV è ideata per l'applicazione posteriore su QUAD, Rider e Atv. Può essere impiegata per lavori di trincatura di erba e arbusti o, più semplicemente, per arrieggiare il terreno.

## STANDARD FEATURES

- Ø 50 MM/2" BALL TYPE COUPLING
- HONDA IGX800 ENGINE
- 2 BELT DRIVE TRANSMISSION WITH SCREW ADJUSTABLE TENSIONER
- ROTOR WITH BLADES OR HAMMERS
- ADJUSTABLE REAR ROLLER
- MECHANIC SIDE SHIFT 56 CM
- CENTRIFUGAL CLUTCH
- FUEL TANK 11L (3 GAL)
- WHEEL POSITION ADJUSTABLE

## CARACTÉRISTIQUES STANDARD

- CROCHET D'ATTELAGE SPHÉRIQUE Ø 50 MM
- MOTEUR HONDA IGX800
- TRANSMISSION PAR 2 COURROIES VENTILÉES PAR TENDEUR À VIS
- ROTOR AVEC COUTEAUX OU MARTEAUX
- ROULEAU ARRIÈRE RÉGLABLE
- DÉPORT LATÉRAL MÉCANIQUE 56 CM
- EMBRAYAGE CENTRIFUGE
- RÉSERVOIR 11L
- POSITION RÉGLABLE DES ROUES

## STANDARD EIGENSCHAFTEN

- ANHÄNGERKUPPLUNG Ø 50 MM
- HONDA IGX800 MOTOR
- ANTRIEB MIT 2 KEILRIEMEN UND EINSTELLBAREM SCHRAUBENSPELLER
- ROTOR MIT Y-MESSER ODER HAMMERSCHLEGEL
- EINSTELLBARE NACHLAUFWALZE
- SEITLICHE VERSCHIEBUNG 56MM NACH RECHTS ODER LINKS
- FRIZIONE CENTRIFUGA
- 11L-TANK
- EINSTELLBARE RÄDER

## CARATTERISTICHE STANDARD

- AGGANCI A TESTINA SFERICO Ø 50 MM
- MOTORE HONDA IGX800
- TRASMISSIONE A 2 CINGHIE VENTILATE CON TENDITORE A VITE REGISTRABILE
- ROTORE A COLTELLI O A MAZZE
- RULLO POSTERIORE REGOLABILE
- SPOSTAMENTO LATÉRALE MECCANICO 56 CM
- FRIZIONE CENTRIFUGA
- SERBATOIO DA 11L
- POSIZIONE RUOTE REGOLABILE



COD-MOD	N.	hp	cm	in	cm	in	n.	n.	kg	lbs	€
<b>Centurion ATV PRO HONDA GX800</b>	<b>2C</b>	<b>25</b>	<b>158</b>	<b>62"</b>	<b>180</b>	<b>72"</b>	<b>48</b>	<b>24</b>	<b>360</b>	<b>794</b>	

Cod.	OPTIONAL	Type	€
------	----------	------	---



**C**

*Rotor with Y blades for universal use- grass  
Rotor avec couteaux pour utilisation universelle - herbe  
Rotor mit Y-Messer für den universellen Einsatz - Gras  
Rotore con coltelli per uso universale - erba*

Centurion ATV  
PRO 158 C

Cod.	OPTIONAL	Type	€
------	----------	------	---



**M**

*Rotor with hammers for specific use- raw land, brambles, pruning  
Rotor avec marteaux - terrains, ronces, élagages  
Rotor mit Hammerschlegel - für vernachlässigter Boden und Gebüsche mit Stacheln  
Rotore con mazze - terreni incolti, rovi, potature*

Centurion ATV  
PRO 158 M

**DIMENSIONS - DIMENSIONS - ABMESSUNGEN - INGOMBRI**

Type	A (cm)	B (cm)	C (cm)
Centurion ATV PRO	<b>200</b>	<b>120</b>	<b>95</b>

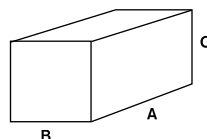

**PACKAGING - EMBALLAGE - VERPACKUNG - IMBALLAGGI**



- Single metal crate
- Caisse Métallique unitaire
- Einzelne Metall Palette
- Cassa singola

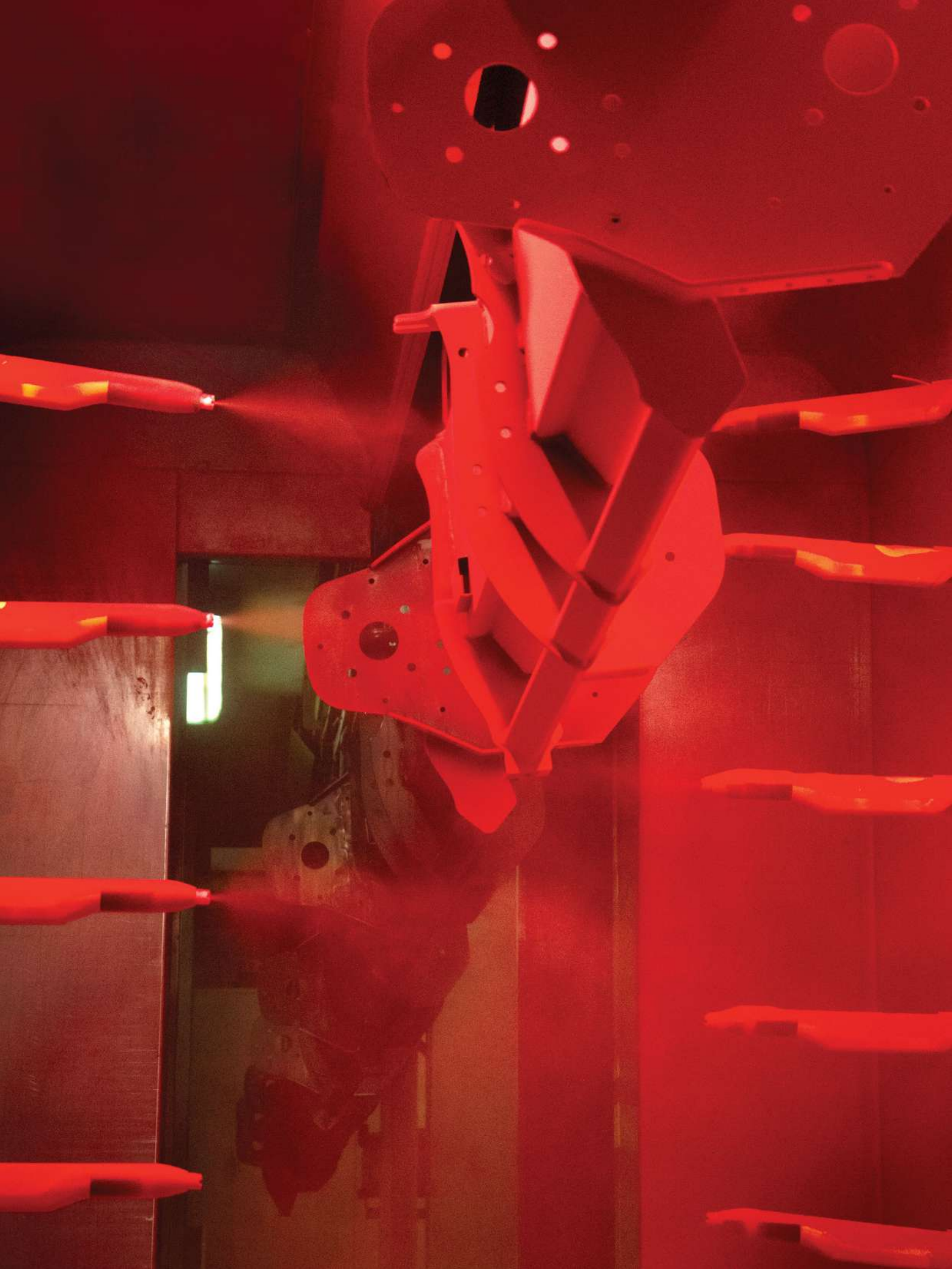

**Finishing mowers**  
**Tondeuses de finition**  
**Feinarbeit Sichelmähwerke**  
**Tagliaerba di finitura**



**ET**

12 - 25 HP

100

102 103



**SRM**

12 - 70 HP

120 / 150 / 180 / 215

104 105



**PRM**

12 - 70 HP

120 / 150 / 180 /  
215 / 235

106 107



**Omega**

40 - 90 HP

11 / 12 / 14 / 15 /  
17 / 19 / 21

108 109



**Direction of rotation**  
**Sens de rotation**  
**Drehrichtung**  
**Senso di rotazione**

**1**

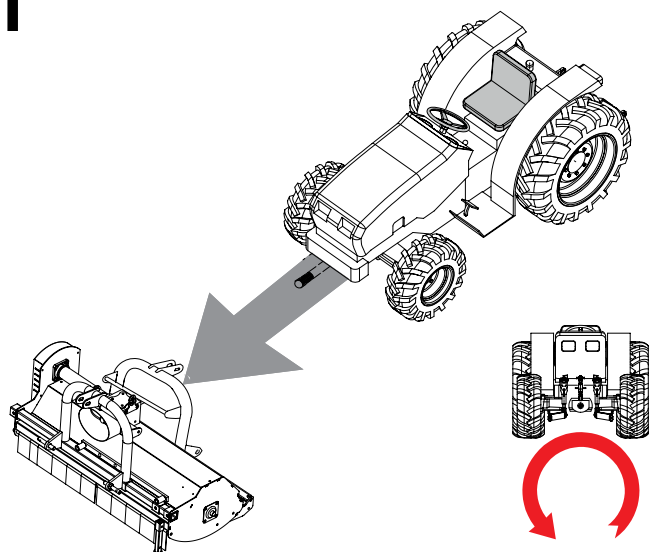

**Front machine**  
**Machine frontale**  
**Frontanbau**  
**Macchina frontale**

RPM – T/min – U/min – giri/min

540	1000	2000
A	B	C

**2**

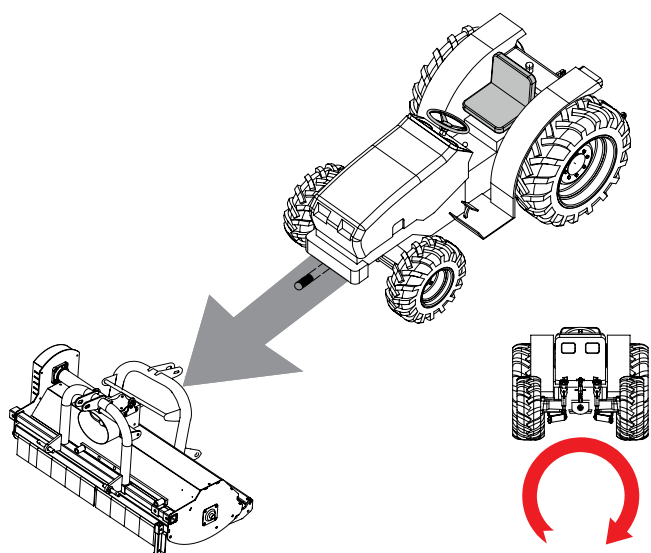

**Front machine**  
**Machine frontale**  
**Frontanbau**  
**Macchina frontale**

RPM – T/min – U/min – giri/min

540	1000	2000
D	E	F

**3**

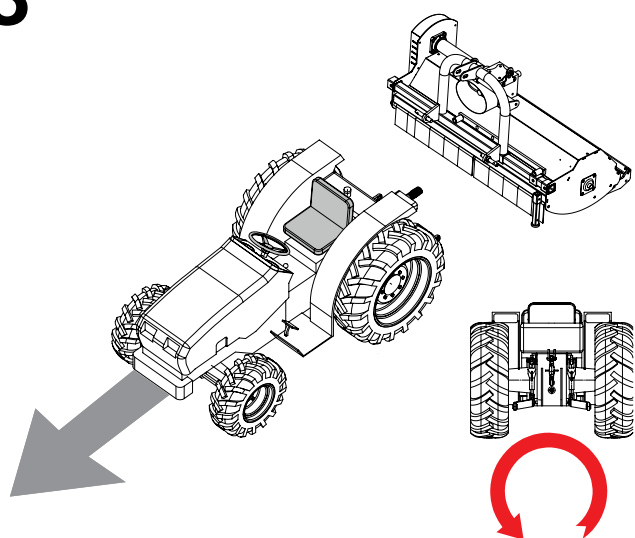

**Rear machine  
Machine arrière  
Heckanbau  
Macchina posteriore**

RPM – T/min – U/min – giri/min

540	1000	2000
<b>G</b>	<b>H</b>	<b>L</b>

**4**

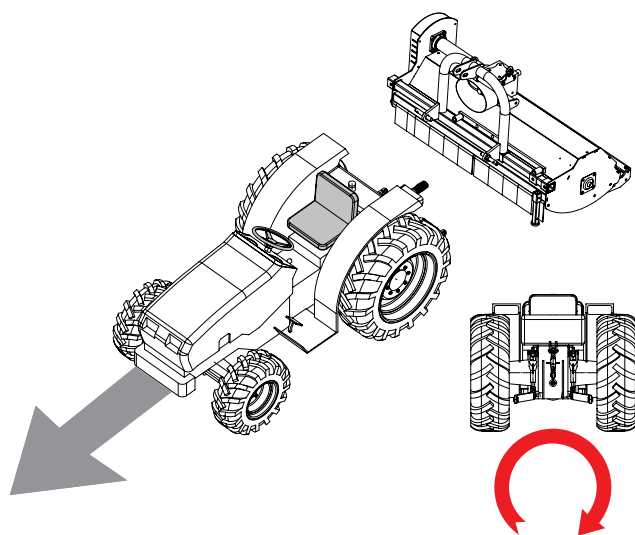

**Rear machine  
Machine arrière  
Heckanbau  
Macchina posteriore**

RPM – T/min – U/min – giri/min

540	1000	2000
<b>M</b>	<b>N</b>	<b>P</b>

# ET 100

**Finishing mower**

**Tondeuse de finition**

**Feinarbeit Sichelmäherwerk**

**Tagliaerba di finitura**

**HP**

**12 - 25**

**kW**

**10 - 20**

**rpm**

**540**



cm 2-9 - inch 1-4



**ENG**

Three different operation modes in one finishing mower: mulching, side discharge and rear discharge. It is perfect for low HP tractors.

**FRA**

Cette machine se caractérise par 3 différents systèmes de coupe: mulching, latérale et arrière. Elle est indiquée pour tracteurs de petites puissances pour la coupe et l'entretien de la couverture herbeuse.

**DEU**

Drei verschiedenen Konfigurationen in ein Rasenmäher: Mulcher, Sietenauswurf und Heckauswurf. Es ist ideal für Kleintraktoren mit wenig PS.

**ITA**

Configurabile in 3 diverse tipologie di scarico dell'erba: mulching, laterale e posteriore. È adatto a piccole potenze per lavorazioni di taglio e manutenzione del manto erboso.

## STANDARD FEATURES

- 3 POINT HITCH, CATEGORY 1
- ALUMINUM GEARBOX 540 RPM WITH INTEGRATED FREE WHEEL DEVICE
- DIRECT DRIVE
- 1 ROTOR WITH 1 BLADE
- ADJUSTABLE HEIGHT
- PIVOTING WHEELS
- UNIVERSAL PTO SHAFT CATEGORY 2 - 1000 MM

## CARACTÉRISTIQUES STANDARD

- ATTELAGE À 3 POINTS 1<sup>o</sup> CATÉGORIE
- BOITIER EN ALUMINIUM 540 T/MIN AVEC ROUE LIBRE INTÉGRÉE
- TRANSMISSION DIRECTE
- ROTOR AVEC 1 LAME
- HAUTEUR DE COUPE RÉGLABLE
- ROUES PIVOTANTES RÉGLABLES
- CARDAN STANDARD 2<sup>o</sup> CATÉGORIE - 1000 MM

## STANDARD EIGENSCHAFTEN

- DREIPUNKTBOCK-ANSCHLUß KATEGORIE 1
- ALUMINIUM-GETRIEBE 540 U/MIN MIT FREILAUF
- DIREKTANTRIEB
- ROTOR MIT 1 MESSER
- DREHBARE STÜTZRÄDER, HÖHENVERSTELLBAR
- STANDARD GELENKWELLE KATEGORIE 2 - 1000 MM

## CARATTERISTICHE STANDARD

- ATTACCO A 3 PUNTI 1<sup>o</sup> CATEGORIA
- RIDUTTORE IN ALLUMINIO 540 G/MIN CON RUOTA LIBERA INTEGRATA
- TRASMISSIONE DIRETTA
- ROTORE CON 1 LAMA
- ALTEZZA DI TAGLIO REGOLABILE
- RUOTE PIVOTANTI
- CARDANO STANDARD 2<sup>o</sup> CATEGORIA - 1000 MM



COD-MOD	hp	cm	in	cm	in	n.	kg	lbs	€
<b>ET 100</b>	<b>12 - 25</b>	<b>100</b>	<b>40"</b>	<b>110</b>	<b>44"</b>	<b>1</b>	<b>125</b>	<b>276</b>	



**DIMENSIONS - DIMENSIONS - ABMESSUNGEN - INGOMBRI**

Type	A (cm)	B (cm)	C (cm)
ET 100	<b>120</b>	<b>110</b>	<b>60</b>

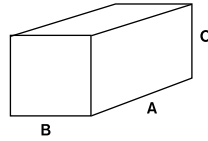

**PACKAGING - EMBALLAGE - VERPACKUNG - IMBALLAGGI**



- Single metal crate
- Caisse Métallique unitaire
- Einzelne Metall Palette
- Cassa singola

# SRM

Rear finishing mower side discharge

Tondeuse de finition attelage arrière éjection latérale

Feinarbeit Heckanbau Seitenauswurf Sichelmäherwerk

Tagliaerba di finitura attacco posteriore scarico laterale

## HP

## 12 - 70

kW

10 - 50

rpm

540 / 1000 / 2000



cm 2-9 - inch 1-4



ENG

This side discharge finishing mower has a high quality cutting system for professional quality and efficient cutting of large areas.

FRA

Pour une parfaite coupe professionnelle de l'herbe, indiquée aussi pour les grandes surfaces, cette machine conjugue en même temps l'efficacité et la qualité de la coupe.

DEU

Dieser Sichelmäherwerk mit Seitenauswurf hat ein hoch leistungs Schneidesystem für professioneller und leistungsfähiger Mähen von grossen Flächen.

ITA

Per una perfetta operazione di taglio dell'erba anche su grandi superfici, coniuga efficacia e qualità di taglio professionali.

### STANDARD FEATURES

- 3 POINT HITCH, CATEGORY 1
- CAST IRON GEARBOX 540 RPM
- BELT DRIVE
- THREE SPINDLES EACH WITH SINGLE BLADE
- SIDE DISCHARGE
- OPTIONAL MULCH-SYSTEM
- ADJUSTABLE HEIGHT, PIVOTING WHEELS
- UNIVERSAL PTO SHAFT, CATEGORY 2 - 1000 MM
- CENTRAL LUBRICATION

### CARACTÉRISTIQUES STANDARD





- ATTELAGE À 3 POINTS 1° CATÉGORIE
- BOITIER EN FONTE 540 T/MIN
- TRANSMISSION PAR 2 COURROIES
- 3 ROTORS AVEC 1 LAME
- ÉJECTION LATÉRALE
- PRÉDISPOSÉE POUR MONTAGE KIT MULCHING
- HAUTEUR REGLABLE, ROUES PIVOTANTES
- CARDAN STANDARD 2° CATÉGORIE - 1000 MM
- LUBRIFICATION CENTRALISÉE DES ARBRES DES LAMES

### STANDARD EIGENSCHAFTEN

- DREIPUNKTBOCK-ANSCHLUß KATEGORIE 1
- GUSSEISENES GETRIEBE 540 U/MIN
- 2 KEILRIEMEN ANTRIEB
- 3 ROTOREN MIT JE 1 MESSER
- SEITENAUSWURF.
- VORBEREITET FÜR DEN EINBAU EINES MULCH-SYSTEMS
- DREHBARE STÜTZRÄDER HÖHENVERSTELLBAR
- STANDARD GELENKWELLE KATEGORIE 2 - 1000 MM
- ZENTRALSCHMIERUNG DER MESSERWELLEN

### CARATTERISTICHE STANDARD

- ATTACCO A 3 PUNTI 1° CATEGORIA
- RIDUTTORE IN GHISA 540 G/MIN
- TRASMISSIONE A 2 CINGHIE
- 3 ROTORI AD 1 LAMA
- SCARICO LATERALE
- PREDISPOSTA PER MONTARE IL KIT MULCHING
- ALTEZZA REGOLABILE, RUOTE PIVOTANTI
- CARDANO STANDARD 2° CATEGORIA - 1000 MM
- LUBRIFICAZIONE DEGLI ALBERI DELLE LAME CENTRALIZZATA

COD-MOD	hp					n.			€
		cm	in	cm	in				
<b>SRM 120</b>	<b>12 - 70</b>	<b>120</b>	<b>48"</b>	<b>145</b>	<b>58"</b>	<b>3</b>	<b>177</b>	<b>390</b>	
<b>SRM 150</b>	<b>12 - 70</b>	<b>150</b>	<b>60"</b>	<b>180</b>	<b>72"</b>	<b>3</b>	<b>207</b>	<b>456</b>	
<b>SRM 180</b>	<b>12 - 70</b>	<b>180</b>	<b>72"</b>	<b>215</b>	<b>86"</b>	<b>3</b>	<b>233</b>	<b>514</b>	
<b>SRM 215</b>	<b>12 - 70</b>	<b>215</b>	<b>85"</b>	<b>250</b>	<b>100"</b>	<b>3</b>	<b>285</b>	<b>628</b>	

Cod.	OPTIONAL	Type	€
	<b>KM</b> <i>Kit mulching - deflectors for frequent cuts</i> <i>Kit mulching - déflecteurs pour coupes fréquents</i> <i>Mulching Kit - Deflektoren für häufige Schnitte</i> <i>Kit mulching - deflettori per tagli frequenti</i>	SRM 120	
		SRM 150	
		SRM 180	
		SRM 215	

	<b>L</b> <i>Additional mulching blades</i> <i>Lames mulching supplémentaires</i> <i>Kreuzmesser</i> <i>Lame supplementari per mulching</i>		
Cod.			€

	<b>A</b> <i>Anti-scalp roller-land with speed bump</i> <i>Rouleau frontal - terrain avec dos</i> <i>Anti-Skalp Walze - Boden mit Unebenheiten</i> <i>Rullo antiscalpo - terreno con dossi</i>		
Cod.			€

Cod.	OPTIONAL	Type	€
	<b>R1</b> <i>Gear box 1000 RPM or 2000 RPM</i> <i>Boîtier pour PDF à 1000/2000 tours</i> <i>Getriebe mit 1000 oder 2000 U/min</i> <i>Riduttori per PDF a 1000 o 2000 RPM</i>		
		<b>R2</b>	
Cod.			€

	<b>P</b> <i>Pneumatic tires- soft lawn and land</i> <i>Roues pneumatiques - prairies et terrains doux</i> <i>Pneumatische Reifen - Wiesen und weiche Böden</i> <i>Ruote pneumatiche - prati e terreni soffici</i>		
Cod.			€

	<b>G</b> <i>Hard rubber wheel - no punctures</i> <i>Roues pleines grandes - sans perçages</i> <i>Volle und Breite Reifen - keine Reifenpanne</i> <i>Ruote piene larghe - no forature</i>		
Cod.			€

**FM** *Front mount - Attelage frontal*  
*Frontanbau - Attacco anteriore*

**DIMENSIONS - DIMENSIONS - ABMESSUNGEN - INGOMBRI**

Type	A (cm)	B (cm)	C (cm)
SRM 120	130	120	60
SRM 150	160	120	60
SRM 180	190	120	60
SRM 215	220	120	60

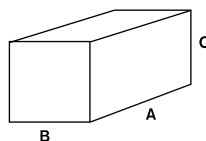

**PACKAGING - EMBALLAGE - VERPACKUNG - IMBALLAGGI**



- Single metal crate
- Caisse Métallique unitaire
- Einzelne Metall Palette
- Cassa singola



# PRM

**Rear finishing mower rear discharge**  
**Tondeuse de finition attelage arrière éjection arrière**  
**Feinarbeit Heckanbau Heckauswurf Sichelmäherwerk**  
**Tagliaerba di finitura attacco posteriore scarico posteriore**

**HP**  
**12 - 70**

kW

10 - 50

rpm

540 / 1000 / 2000



cm 2-9 - inch 1-4



ENG

This rear discharge finishing mower has a high quality cutting system for professional quality and efficient cutting of large areas.

FRA

Tondeuse frontale parfaite pour une coupe professionnelle de l'herbe, indiquée aussi pour les grandes surfaces, cette machine conjugue en même temps l'efficacité et la qualité de coupe.

DEU

Dieser Sichelmäherwerk mit Heckauswurf hat ein hoch leistungs Schneidesystem für professioneller und leistungsfähiger Mähen von grossen Flächen.

ITA

Per una perfetta operazione di taglio dell'erba anche su grandi superfici, coniuga efficacia e qualità di taglio professionali.

## STANDARD FEATURES

- 3 POINT HITCH, CATEGORY 1
- CAST IRON GEARBOX 540 RPM
- 2 - BELT DRIVE
- 3 SPINDLES EACH WITH SINGLE BLADE, XRM 235: 5 SPINDLES EACH WITH SINGLE BLADE
- REAR DISCHARGE
- OPTIONAL MULCH-SYSTEM
- ADJUSTABLE HEIGHT, PIVOTING WHEELS
- UNIVERSAL PTO SHAFT, CATEGORY 2 - 1000 MM, XRM - 800 MM
- CENTRAL LUBRICATION

## CARACTÉRISTIQUES STANDARD

- ATTELAGE À 3 POINTS 1° CATÉGORIE.
- BOÎTIER EN FONTE 540 T/MIN
- TRANSMISSION PAR 2 COURROIES
- 3 ROTORS AVEC 1 LAME, XRM 235: 5 ROTORS AVEC 1 LAME
- ÉJECTION ARRIÈRE
- PRÉDISPOSÉE POUR MONTAGE DU KIT MULCHING
- HAUTEUR DE COUPE RÉGLABLE, ROUES PIVOTANTES RÉGLABLES
- CARDAN STANDARD 2° CATÉGORIE - 1000 MM, XRM - 800 MM
- LUBRIFICATION CENTRALISÉE DES ARBRES DES LAMES

## STANDARD EIGENSCHAFTEN

- DREIPUNKTBOCK-ANSCHLUß KATEGORIE 1
- GUSSEISENES GETRIEBE 540 U/MIN
- KEILRIEMEN ANTRIEB
- 3 ROTOREN MIT JE 1 MESSER. XRM 235: 5 ROTOREN MIT JE 1 MESSER
- HECKAUSWURF
- VORBEREITET FÜR DEN EINBAU EINES MULCH-SYSTEMS
- DREHBARE STÜTZRÄDER HÖHENVERSTELLBAR
- STANDARD GELENKWELLE KATEGORIE 2 - 1000 MM, XRM - 800 MM
- ZENTRALSCHMIERUNG DER MESSERWELLEN

## CARATTERISTICHE STANDARD

- ATTACCO A 3 PUNTI 1° CATEGORIA
- RIDUTTORE IN GHISA 540 G/MIN.
- TRASMISSIONE A 2 CINGHIE
- 3 ROTORI A 1 LAMA, XRM 235: 5 ROTORI A 1 LAMA
- SCARICO POSTERIORE
- PREDISPOSTA PER MONTARE IL KIT MULCHING
- ALTEZZA DI TAGLIO REGOLABILE, RUOTE PIVOTANTI
- CARDANO STANDARD 2° CATEGORIA - 1000 MM, XRM - 800 MM
- LUBRIFICAZIONE DEGLI ALBERI DELLE LAME CENTRALIZZATA

COD-MOD	hp					n.			€
		cm	in	cm	in				
<b>PRM 120</b>	12 - 70	120	48"	130	52"	3	180	397	
<b>PRM 150</b>	12 - 70	150	60"	160	64"	3	211	465	
<b>PRM 180</b>	12 - 70	180	72"	190	76"	3	239	527	
<b>PRM 215</b>	12 - 70	215	85"	225	90"	3	289	637	
<b>XRM 235</b>	12 - 70	235	93"	245	98"	5	320	705	

Cod.	OPTIONAL	Type	€
	<b>KM</b> <i>Kit mulching - deflectors for frequent cuts</i> <i>Kit mulching - déflecteurs pour coupes fréquents</i> <i>Mulching Kit - Deflektoren für häufige Schnitte</i> <i>Kit mulching - deflettori per tagli frequenti</i>	PRM 120	
		PRM 150	
		PRM 180	
		PRM 215	
		XRM 235	

Cod.	OPTIONAL	Type	€
	<b>A</b> <i>Anti-scalp roller-land with speed bump</i> <i>Rouleau frontal - terrain avec dos</i> <i>Anti-Skalp Walze - Boden mit Unebenheiten</i> <i>Rullo antiscalpo - terreno con dossi</i>	XRM 235	

Cod.	OPTIONAL	Type	€
	<b>R1</b> <i>Gear box 1000 RPM or 2000 RPM</i> <i>Boîtier pour PDF à 1000/2000 tours</i> <i>Getriebe mit 1000 oder 2000 U/min</i> <i>Riduttori per PDF a 1000 o 2000 RPM</i>	1.000 rpm	
		2.000 rpm	

Cod.	OPTIONAL	Type	€
	<b>P</b> <i>Pneumatic tires- soft lawn and land</i> <i>Roues pneumatiques - prairies et terrains doux</i> <i>Pneumatische Reifen - Wiesen und weiche Böden</i> <i>Ruote pneumatiche - prati e terreni soffici</i>		

Cod.	OPTIONAL	Type	€
	<b>G</b> <i>Hard rubber wheel- no punctures</i> <i>Roues pleines grandes - sans perçages</i> <i>Volle und Breite Reifen - keine Reifenpanne</i> <i>Ruote piene larghe - no forature</i>		

Cod.	OPTIONAL	Type	€
<b>FM</b>	<i>Front mount - Attelage frontal</i> <i>Frontanbau - Attacco anteriore</i>		

**DIMENSIONS - DIMENSIONS - ABMESSUNGEN - INGOMBRI**

Type	A (cm)	B (cm)	C (cm)
PRM 120	130	120	60
PRM 150	160	120	60
PRM 180	190	120	60
PRM 215	220	120	60
XRM 235	240	120	60

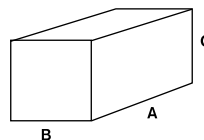

**PACKAGING - EMBALLAGE - VERPACKUNG - IMBALLAGGI**



- Single metal crate
- Caisse Métallique unitaire
- Einzelne Metall Palette
- Cassa singola

# Omega

**3 - Gang mower**  
**Tondeuse de finition**  
**Feinarbeit Sichelmähwerk**  
**Tagliaerba di finitura**

**HP**  
**40 - 90**

**kW**  
**30 - 75**

**rpm**  
**540**

 **cm 2-9 - inch 1-4**



**ENG**

This gang mower is an excellent choice for sports fields, parks, large meadows, etc. thanks to its high quality components.

## STANDARD FEATURES

- MAIN FRAME WITH 2 PNEUMATIC TIRES
- TRANSMISSION WITH WIDE ANGLE PTO SHAFT
- MOWERS RAISED AND LOWERED HYDRAULICALLY
- 3 PRM/XRM FINISHING MOWERS WITH CAST IRON GEARBOX 540 RPM AND BELT DRIVE
- REAR DISCHARGE AND OPTIONAL MULCHING SYSTEM
- ADJUSTABLE HEIGHT, PIVOTING WHEELS
- CATEGORY 5, UNIVERSAL SLIP CLUTCH - 1000 MM
- CENTRAL LUBRICATION
- ANTI-SCALP ROLLERS

**FRA**

Il s'agit d'une machine professionnelle conçue avec des matériaux de haute qualité, pour résister aux nombres d'heures importantes exécutées pour tondre les gazons des grandes surfaces, comme les parcs d'espace verts, ou le terrains de golf.

## CARACTÉRISTIQUES STANDARD

- CHÂSSIS TRAINÉ AVEC 2 ROUES PNEUMATIQUES
- TRANSMISSION AVEC CARDAN HOMOCINÉTIQUE ET CIRCUIT HYDRAULIQUE POUR LE RELEVAGE DES TROIS ÉLÉMENTS
- TONDEUSE DE FINITION 3 PRM/XRM: BOITIERS EN FONTE 540 T/MIN AVEC TRANSMISSION PAR COURROIES
- ÉJECTION ARRIÈRE AVEC L'OPTION KIT MULCHING
- HAUTEUR DE COUPE RÉGLABLE, ROUES PIVOTANTES RÉGLABLES
- CARDAN FRICTION STANDARD 5° CATÉGORIE - 1000 MM
- LUBRIFICATION CENTRALE
- ROULEAUX SCALPEURS

**DEU**

Dieser Kombi-Mähwerk ist die richtige Wahl für Sportfelder, Parkanlagen, Wiesenflächen, usw wegen seine hochwertige Komponenten.

## STANDARD EIGENSCHAFTEN

- ZUGRAHMEN MIT 2 LUFTREIFEN
- WEITWINKELGELENKWELLE UND HYDRAULIKSYSTEM ZUR HEBUNG DER MÄHWERKE
- 3 PRM/XRM MÄHWERKE MIT: GUSSEISEN GETRIEBE 540 U/MIN
- KEILRIEMEN ANTRIEB
- HECKAUSWURF
- VORBEREITET FÜR DAS EINBAU EINES MULCH-SYSTEM
- DREHBARE STÜTZRÄDER HÖHENVERSTELLBAR
- STANDARD GELENKWELLE KATEGORIE 5 - 1000 MM
- ZENTRALSCHMIERUNG
- ANTISKALP WALZE

**ITA**

Di concezione professionale sia nella forma che nella qualità dei materiali impiegati, è adatta ad essere impiegata nei prati di grandi dimensioni, campi da golf, parchi ecc.

## CARATTERISTICHE STANDARD

- TELAIO CARRELLATO CON 2 RUOTE PNEUMATICHE
- TRASMISSIONE CON CARDANI OMOCINETICI E IMPIANTO IDRAULICO PER IL SOLLEVAMENTO DEI TRE ELEMENTI
- 3 RASAERBA PRM/XRM: RIDUTTORI IN GHISA 540 G/MIN CON TRASMISSIONE A CINGHIA
- ELEMENTI CON SCARICO POSTERIORE CON POSSIBILITÀ OPZIONE KIT MULCHING
- ALTEZZA DI TAGLIO REGOLABILE E RUOTE PIVOTANTI
- CARDANO STANDARD 5° CATEGORIA FRIZIONE - 1000 MM
- LUBRIFICAZIONE CENTRALIZZATA
- RULLI ANTISCALPO







COD-MOD	hp	cm	in						kg	lbs	€	
				120	150	180	215	235	kg	lbs		
<b>Omega 11</b>	40 - 90	330	132	3						1244	2743	
<b>Omega 12</b>	40 - 90	360	144	2	1					1261	2780	
<b>Omega 14</b>	40 - 90	420	168		3					1266	2791	
<b>Omega 15</b>	40 - 90	450	180		2	1				1270	2800	
<b>Omega 17</b>	40 - 90	510	204			3				1442	3179	
<b>Omega 19</b>	40 - 90	565	222			2		1		1479	3261	
<b>Omega 21</b>	40 - 90	635	240				2	1		1521	3353	

Cod.	OPTIONAL	Type	€
 <b>KM</b>	<i>Kit mulching - deflectors for frequent cuts</i> <i>Kit mulching - déflecteurs pour coupes fréquents</i> <i>Mulching Kit - Deflektoren für häufige Schnitte</i> <i>Kit mulching - deflettori per tagli frequenti</i>	PRM 120	
		PRM 150	
		PRM 180	
		PRM 215	
		XRM 235	

Cod.		€
<b>O</b>	<i>Wide- angle PTO shaft - closed curves</i> <i>Cardan homocinétique - virages très serrés</i> <i>Weitwinkelgelenkwelle - enge Kurven</i> <i>Cardano omocinetico - curve strette</i>	

Cod.		€
 <b>P</b>	<i>Pneumatic tires- soft lawn and land</i> <i>Roues pneumatiques - prairies et terrains doux</i> <i>Pneumatische Reifen - Wiesen und weiche Böden</i> <i>Ruote pneumatiche - prati e terreni soffici</i>	

Cod.		€
 <b>G</b>	<i>Hard rubber wheel- no punctures</i> <i>Roues pleines grandes - sans perçages</i> <i>Volle und Breite Reifen - keine Reifenpanne</i> <i>Ruote piene larghe - no forature</i>	

**DIMENSIONS - DIMENSIONS - ABMESSUNGEN - INGOMBRI**

Type	A (cm)	B (cm)	C (cm)
Omega 11	406	240	240
Omega 12	406	240	240
Omega 14	406	240	240
Omega 15	406	240	240
Omega 17	340	240	240
Omega 19	240	150	240
Omega 21	240	150	240

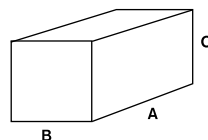



TruBend 5230



**Bio shredders**  
**Broyeurs a vegetaux**  
**Holzhäcksler**  
**Biotrituratori**



**BiOnda**

5 Ø cm

G 210 /  
 GP 160 /  
 Electric

112 113



**Pugio**

5 - 6 Ø cm

GP 160 /  
 GP 200 / 3 P

114 115



**Vulcan**

5 - 7 Ø cm

G 420 /  
 GP 200 /  
 GX 270 / 3 P

116 117



**Scutum**

7 - 9 Ø cm

GX 270 /  
 GX 390 / 3 P

118 119



**Argo**

10 Ø cm

3 P

120 121



**Scorpion**

12 - 14 Ø cm

Scorpion  
 Scorpion NS

122 123

**Back hoes**  
**Retropelles**  
**Dreipunkthydraulikbagger**  
**Retroescavatori**



**RES 10**

10 - 35 HP

124 125



**RES  
 15/20/30**

15 - 60 HP

126 127

**Potato diggers**  
**Arracheuses de pomme de terre**  
**Kartoffelroder**  
**Cavapatate**



**DM 50**

12 - 30 HP

128



**DM 100**

30 - 50 HP

129



# Bionda

**Bio Shredder**  
**Broyeur a végétaux**  
**Holzhäcksler**  
**Biotrituratore**

Ø MAX cm 5 / 6 - inch 2



ENG

This bio shredder is suitable for semi-professional use. The quality/price ratio is one of the best in its field.

FRA

Ce broyeur composteur est indiqué pour une utilisation semi professionnelle et son rapport qualité/prix est incomparable dans sa catégorie.

DEU

Dieser Bio Häcksler ist für den semi professionellen Einsatz konzipiert. Das Preis/Leistungs Verhältnis ist ausserordentlich in seiner Kategorie.

ITA

Trituratore adatto ad un utilizzo semi professionale. Il suo rapporto qualità/prezzo lo rende insuperabile nella sua categoria.

## STANDARD FEATURES

- 1ST QUALITY STEEL FRAME, HIGH STRENGTH, THICKNESS 4 MM LASER CUT, MACHINE BENT AND WELDED BY ROBOT
- BELT DRIVE WITH TENSIONER
- ROTOR BALANCED ELECTRONICALLY, FORCED VENTILATION, STEEL BEARING SUPPORTS, HIGHLY RESISTANT STEEL SHAFT
- 6 SWINGING REVERSIBLE HAMMERS AND ONE BLADE OF HIGH RESISTANCE TEMPERED STEEL WITH QUICK REPLACEMENT SYSTEM
- ADJUSTABLE COUNTER BLADE, EASILY REPLACEABLE
- SELF-CLEANING SCREEN WITH LONGITUDINAL SLOTS AND QUICK REMOVAL SYSTEM
- TUBELESS TIRES Ø 200 MM WITH STEEL RIMS AND RUBBER TREAD

## CARACTÉRISTIQUES STANDARD

- STRUCTURE EN ACIER DE PREMIÈRE QUALITÉ, HAUTE RÉSIDENCE, ÉPAISSEUR AU LASER DE 4 MM, PLIÉ ET SOUDÉ
- TRANSMISSION PAR COURROIE AVEC TENDEUR PAR VIS
- ROTOR: VENTILATION FORCÉE, SUPPORT ROULEMENTS EN FONTE; AXE EN ACIER
- 6 MARTEAUX REVERSIBLES ET UNE LAME EN ACIER TÉMPÉRÉ À HAUTE RÉSIDENCE AVEC SYSTÈME DE REMPLACEMENT RAPIDE ÉQUILIBRÉ ÉLECTRONIQUÉMENT
- CONTRE-LAME RÉVERSIBLE À SECTION VARIABLE.
- AUTONETTOYAGE AVEC TAMIS LONGITUDINAUX ET DÉMONTAGE DU SYSTÈME RAPIDE
- ROUES DE DIAMÈTRE 200 MM PROFESSIONNELLES. JANTE EN ACIER ET BANDE DE ROULEMENT EN CAOUTCHOUC

## STANDARD EIGENSCHAFTEN

- STAHLRAHMEN, ERSTE QUALITÄT, WIDERSTANDSFÄHIG, 4 MM DICK WIRD MIT LASER GESCHNITTEN, AUTOMATISCH GEBOGEN UND MIT ROBOTERN GESCHWEISST
- KEILRIEMEN ANTRIEB (QUERSCHNITT B) MIT VERSTELLBAREM SPANNER.
- ROTOR AUS HOCHLEISTUNG-STAHL MIT LÜFTUNG, KUGELLAGER IN GUSSEISEN HALTERUNGEN ELEKTRONISCH AUSGEWUCHTET
- 6 REVERSIBLEN HÄMMERN UND EIN MESSER AUS GEHÄRTETEM STAHL MIT SCHNELLEN ERSATZSYSTEM
- LEICHT AUSTAUSCHBARES UND VERSTELLBARES GEGEN-MESSER
- SELBST-REINIGENDES SIEB, SCHNELL AUSWECHSELBAR, MIT LÄNGSSCHLITZE
- PNEUMATIK REIFEN 200 MM DURCHMESSER MIT STAHLFELGEN

## CARATTERISTICHE STANDARD

- STRUTTURA IN ACCIAIO DI PRIMA QUALITÀ, ALTA RESISTENZA, SPESSORE 4 MM, TAGLIATO, PIEGATO E SALDATO CON MACCHINARI CNC
- TRASMISSIONE A CINGHIA, CON TENDITORE A VITE
- ROTORE: VENTILAZIONE FORZATA, SUPPORTO CUSCINETTI IN GHISA, ASSE IN ACCIAIO AD ALTA RESISTENZA, BILANCIATO ELETTRONICAMENTE
- 6 MARTELLI/COLTELLI IN ACCIAIO TEMPERATO AD ALTA RESISTENZA CON SISTEMA DI SOSTITUZIONE RAPIDA
- CONTROCOLTELLO INTERCAMBIABILE A SEZIONE VARIABILE
- FUNZIONE DI AUTOPULIZIA CON SETACCI LONGITUDINALI
- RUOTE PROFESSIONALI Ø 200 MM, CERCHI IN ACCIAIO E BATTISTRADA IN GOMMA



COD-MOD	version	hp	kW	Hz	cm Ø	in Ø	n.	n.	kg	lbs	€
<b>BIONDA</b>	<b>Loncin G 210</b>	<b>7</b>	-	-	<b>5</b>	<b>2"</b>	<b>1</b>	<b>6</b>	<b>75</b>	<b>165</b>	
<b>BIONDA</b>	<b>Honda GP 160</b>	<b>5,5</b>	-	-	<b>5</b>	<b>2"</b>	<b>1</b>	<b>6</b>	<b>78</b>	<b>172</b>	
<b>E-BIONDA 220</b>	<b>Electric 230V</b>	-	<b>3 kW</b>	<b>50</b>	<b>5</b>	<b>2"</b>	<b>1</b>	<b>6</b>	<b>85</b>	<b>187</b>	
<b>E-BIONDA 400</b>	<b>Electric 400/460V</b>	-	<b>3 kW</b>	<b>50/60</b>	<b>5</b>	<b>2"</b>	<b>1</b>	<b>6</b>	<b>85</b>	<b>187</b>	

**DIMENSIONS - DIMENSIONS - ABMESSUNGEN - INGOMBRI**

Type	A (cm)	B (cm)	C (cm)
Bionda	<b>90</b>	<b>55</b>	<b>105</b>

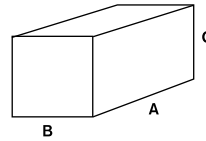

**PACKAGING - EMBALLAGE - VERPACKUNG - IMBALLAGGI**



- \_\_\_\_\_ Box + Pallet
- \_\_\_\_\_ Carton + Palette
- \_\_\_\_\_ Box + Palette
- \_\_\_\_\_ Scatola + Pallet

# Pugio

**Bio Shredder**  
**Broyeurs a vegetaux**  
**Holzhäcksler**  
**Biotrituratore**

Ø MAX cm 5 / 6 - inch 2



ENG

This bio shredder is suitable for semi-professional use.

## STANDARD FEATURES

- 1ST QUALITY STEEL FRAME, HIGHLY RESISTANT, ANTI VIBRATION, THICKNESS 5 MM LASER CUT, MACHINE BENT AND WELDED BY ROBOT
- BELT DRIVE (SECTION B) WITH TENSIONER
- ROTOR: FORCES VENTILATION, STEEL BEARING SUPPORTS, HIGHLY RESISTANT STEEL SHAFT
- 6 SWINGING REVERSIBLE HAMMERS AND ONE BLADE OF HIGH RESISTANCE TEMPERED STEEL WITH QUICK REPLACEMENT SYSTEM, BALANCED ELECTRONICALLY
- ADJUSTABLE COUNTER BLADE, EASILY REPLACEABLE
- SELF-CLEANING SCREEN WITH LONGITUDINAL SLOTS AND QUICK REMOVAL SYSTEM
- TUBELESS TIRES 210 MM DIAMETER WITH STEEL RIMS AND RUBBER TREAD
- PTO VERSION, CATEGORY 1 CARDAN SHAFT - 700 MM
- ENGINE VERSION: IT CAN BE SUPPLIED WITH HONDA GP160 OR GP200 ENGINE

FRA

Indiqué pour une utilisation semi professionnelle.

## CARACTÉRISTIQUES STANDARD

- STRUCTURE EN ACIER DE HAUTE QUALITÉ, POUR RESISTER AUX FORTES CONTRAINTES DE BROYAGES ÉPASSIEUR DES TOLES 5 MM DECOUPE LASER, PLIÉ ET SOUDÉ
- ROTOR: VENTILATION FORCÉE, SUPPORT ROULEMENTS EN FONTE; AXE EN ACIER
- ROTOR EQUIPÉ DE 6 MARTEAUX REVERSIBLES EN ACIER HAUTE RÉSISTANCE AVEC SYSTÈME DE REMPLACEMENT RAPIDE ÉQUILIBRÉ ÉLECTRONIQUEMENT
- CONTRE-LAME RÉVERSIBLE À SECTION VARIABLE
- AUTONETTOYAGE AVEC TAMIS LONGITUDINAUX ET DÉMONTAGE DU SYSTÈME RAPIDE
- ROUES DE DIAMÈTRE 210 MM PROFESSIONNELLES. JANTE EN ACIER ET BANDE DE ROULEMENT EN CAOUTCHOUC
- VERSION PDF, CARDAN 1<sup>o</sup>CATÉGORIE - 700 MM
- VERSION MOTEUR: FOURNI AVEC MOTEUR HONDA GP160 OU GP200

DEU

Dieser Bio Häcksler ist für den semi professionellen Einsatz geeignet.

## STANDARD EIGENSCHAFTEN

- STAHLRAHMEN, ERSTE QUALITÄT, WIDERSTANDSFÄHIG, 5 MM DICK UM VIBRATIONEN ZU VERMEIDEN, WIRD MIT LASER GESCHNITTEN, AUTOMATISCH GEBOGEN UND MIT ROBOTER GESCHWEIßT
- KEILRIEMEN ANTRIEB (QUERSCHNITT B) MIT VERSTELLBARER SPANNER
- ROTOR AUS HOCHLEISTUNG-STAHL MIT LÜFTUNG, KUGELLAGER IN GÜBEISEN HALTERUNGEN
- 6 REVERSIBLEN HÄMMERN UND EIN MESSER AUS GEHÄRTETEM STAHL MIT SCHNELLEN ERSATZSYSTEM
- LEICHT AUSTAUSCHBARES UND VERSTELLBARES GEGEN-MESSER
- SELBST-REINIGENDES SIEB, SCHNELL AUSWECHSELBAR, MIT LÄNGSSCHLITZE
- PNEUMATIK REIFEN 210 MM DURCHMESSER MIT STAHLFELGEN
- PTO VERSION MIT KATEGORIE 1 GELENKWELLE - 700 MM
- MOTOR VERSION: LIEFERUNG ENTHÄLT HONDA MOTOR GP160 ODER GP200

ITA

Trituratore adatto ad un utilizzo semi professionale.

## CARATTERISTICHE STANDARD

- STRUTTURA IN ACCIAIO DI PRIMA QUALITÀ, ALTA RESISTENZA, ANTI-VIBRAZIONI, SPESSORE 5 MM, TAGLIATO, PIEGATO E SALDATO CON MACCHINARI CNC
- TRASMISSIONE A CINGHIA, SEZIONE B, CON TENDITORE A VITE
- ROTORE: VENTILAZIONE FORZATA, SUPPORTO CUSCINETTI IN GHISA, ASSE IN ACCIAIO AD ALTA RESISTENZA
- DOTATO DI 6 MARTELLI/COLTELLI IN ACCIAIO TEMPERATO AD ALTA RESISTENZA CON SISTEMA DI SOSTITUZIONE RAPIDA, BILANCIATO ELETTRONICAMENTE
- CONTROCOLTELLO INTERCAMBIABILE A SEZIONE VARIABILE
- FUNZIONE DI AUTOPULIZIA CON SETACCI LONGITUDINALI
- RUOTE PROFESSIONALI 210 MM DI DIAMETRO CON CERCHI IN ACCIAIO E BATTISTRADA IN GOMMA
- VERSIONE PTO, CARDANO 1<sup>o</sup> CATEGORIA - 700 MM
- VERSIONE MOTORE: FORNITO CON MOTORE HONDA GP160 O GP200



COD-MOD	version	hp	cm	in	n.	n.	kg	lbs	€
<b>PUGIO GP 160</b>	<b>Honda GP 160</b>	<b>5,5</b>	<b>5 - 6</b>	<b>1,6-2"</b>	<b>1</b>	<b>6</b>	<b>90</b>	<b>198</b>	
<b>PUGIO GP 200</b>	<b>Honda GP 200</b>	<b>6,5</b>	<b>5 - 6</b>	<b>1,6-2"</b>	<b>1</b>	<b>6</b>	<b>97</b>	<b>214</b>	
<b>PUGIO 3P</b>	<b>Tractor PTO 3P</b>	<b>10 - 30</b>	<b>5 - 6</b>	<b>1,6-2"</b>	<b>1</b>	<b>6</b>	<b>97</b>	<b>214</b>	

Cod.	OPTIONAL	€
------	----------	---



**T**

3 point hitch for tractor PTO  
 Attelage à la prise de force du tracteur  
 Anschluss an der Zapfwelle des Traktors  
 Attacco alla PDF del trattore

**DIMENSIONS - DIMENSIONS - ABMESSUNGEN - INGOMBRI**

Type	A (cm)	B (cm)	C (cm)
Pugio	<b>90</b>	<b>72</b>	<b>105</b>

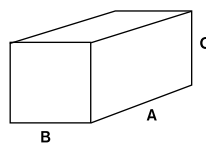

**PACKAGING - EMBALLAGE - VERPACKUNG - IMBALLAGGI**



- Box + Pallet
- Carton + Palette
- Box + Palette
- Scatola + Pallet

# Vulcan

**Bio Shredder**  
**Broyeurs a vegetaux**  
**Holzhäcksler**  
**Biotrituratore**

Ø MAX cm 5 - 7 - inch 2



ENG

Bio shredder designed for semi-professional use. It guarantees reliable and efficient operation.

FRA

Broyeur de branche étudié pour une utilisation semi-professionnel. Il assure un travail sur et efficace.

DEU

Für den semiprofessionellen Einsatz geeignet. Er Garantiert sichere und effektive Häckselarbeiten.

ITA

Trituratore studiato per un utilizzo semi-professionale. Garantisce una lavorazione sicura ed efficace.

## STANDARD FEATURES

- 1ST QUALITY STEEL FRAME, HIGHLY RESISTANT, ANTI VIBRATION, THICKNESS 5 MM LASER CUT, MACHINE BENT AND WELDED BY ROBOT
- BELT DRIVE (SECTION B) WITH TENSIONER
- ROTOR: FORCES VENTILATION, STEEL BEARING SUPPORTS, HIGHLY RESISTANT STEEL SHAFT
- 6 SWINGING REVERSIBLE HAMMERS AND TWO BLADES OF HIGH RESISTANCE TEMPERED STEEL WITH QUICK REPLACEMENT SYSTEM, BALANCED ELECTRONICALLY
- ADJUSTABLE COUNTER BLADE, EASILY REPLACEABLE
- SELF-CLEANING SCREEN WITH LONGITUDINAL SLOTS AND QUICK REMOVAL SYSTEM
- TUBELESS TIRES 210 MM DIAMETER WITH STEEL RIMS AND RUBBER TREAD
- PTO VERSION, CATEGORY 1 CARDAN SHAFT - 700 MM
- ENGINE VERSION: IT CAN BE SUPPLIED WITH HONDA GP200 OR GX270 ENGINE

## CARACTÉRISTIQUES STANDARD

- STRUCTURE EN ACIER DE HAUTE QUALITÉ, POUR RESISTER AUX FORTES CONTRAINTES DE BROYAGES ÉPASSIEUR DES TOLES 5 MM DECOUPE LASER, PLIÉ ET SOUDÉ
- ROTOR: VENTILATION FORCÉE, SUPPORT ROUEMENTS EN FONTE; AXE EN ACIER
- ROTOR EQUIPÉ DE 6 MARTEAUX REVERSIBLES EN ACIER HAUTE RÉSISTANCE AVEC SYSTÈME DE REMPLACEMENT RAPIDE ÉQUILIBRÉ ÉLECTRONIQUEMENT
- CONTRE-LAME RÉVERSIBLE À SECTION VARIABLE
- AUTONETTOYAGE AVEC TAMIS LONGITUDINAUX ET DÉMONTAGE DU SYSTÈME RAPIDE
- ROUES DE DIAMÈTRE 210 MM PROFESSIONNELLES. JANTE EN ACIER ET BANDE DE ROULEMENT EN CAOUTCHOUC
- VERSION PDF, CARDAN 1<sup>o</sup>CATÉGORIE - 700 MM
- VERSION MOTEUR: FOURNI AVEC MOTEUR HONDA GP200 OU GX270

## STANDARD EIGENSCHAFTEN

- STAHLRAHMEN, ERSTE QUALITÄT, WIDERSTANDSFÄHIG, 5 MM DICK UM VIBRATIONEN ZU VERMEIDEN, WIRD MIT LASER GESCHNITTEN, AUTOMATISCH GEBOGEN UND MIT ROBOTER GESCHWEIßT
- KEILRIEMEN ANTRIEB (QUERSCHNITT B) MIT VERSTELLBARER SPANNER
- ROTOR AUS HOCHLEISTUNG-STAHL MIT LÜFTUNG, KUGELLAGER IN GÜBEISEN HALTERUNGEN
- 6 REVERSIBLEN HÄMMERN UND EIN MESSER AUS GEHÄRTETEM STAHL MIT SCHNELLEN ERSATZSYSTEM
- LEICHT AUSTAUCHBARES UND VERSTELLBARES GEGEN-MESSER
- SELBST-REINIGENDES SIEB, SCHNELL AUSWECHSELBAR, MIT LÄNGSSCHLITZE
- PNEUMATIK REIFEN 210 MM DURCHMESSER MIT STAHLFELGEN
- PTO VERSION MIT KATEGORIE 1 GELENKWELLE - 700 MM
- MOTOR VERSION: LIEFERUNG ENTHÄLT HONDA MOTOR GP200 ODER GX270

## CARATTERISTICHE STANDARD

- STRUTTURA IN ACCIAIO DI PRIMA QUALITÀ, ALTA RESISTENZA, SPESSORE 5 MM, TAGLIATO, PIEGATO E SALDATO CON MACCHINARI CNC
- TRASMISSIONE A CINGHIA, SEZIONE B, CON TENDITORE A VITE  
ROTORE: VENTILAZIONE FORZATA, SUPPORTO CUSCINETTI IN GHISA, ASSE IN ACCIAIO AD ALTA RESISTENZA
- DOTATO DI 6 MARTELLI, 2 COLTELLI IN ACCIAIO TEMPERATO AD ALTA RESISTENZA CON SISTEMA DI SOSTITUZIONE RAPIDA, BILANCIATO ELETTRONICAMENTE
- CONTROCOLTELLO INTERCAMBIABILE A SEZIONE VARIABILE
- FUNZIONE DI AUTOPULIZIA CON SETACCI LONGITUDINALI
- RUOTE PROFESSIONALI 210 MM DI DIAMETRO CON CERCHI IN ACCIAIO E BATTISTRADA IN GOMMA
- VERSIONE PTO, CARDANO 1<sup>o</sup> CATEGORIA - 700 MM
- VERSIONE MOTORE: FORNITO CON MOTORE HONDA GP200 O GX270

COD-MOD	version	hp	cm	in	n.	n.	kg	lbs	€
<b>VULCAN GP 200</b>	<b>Honda GP 200</b>	<b>6,5</b>	<b>5 - 7</b>	<b>1,6 - 2"</b>	<b>2</b>	<b>6</b>	<b>109</b>	<b>240</b>	
<b>VULCAN GX 270</b>	<b>Honda GX 270</b>	<b>9</b>	<b>5 - 7</b>	<b>1,6 - 2"</b>	<b>2</b>	<b>6</b>	<b>118</b>	<b>260</b>	
<b>VULCAN GX 390</b>	<b>Honda GX 390</b>	<b>13</b>	<b>5 - 7</b>	<b>1,6 - 2"</b>	<b>2</b>	<b>6</b>	<b>130</b>	<b>260</b>	
<b>VULCAN G 420</b>	<b>Loncin G 420</b>	<b>14</b>	<b>5 - 7</b>	<b>1,6 - 2"</b>	<b>2</b>	<b>6</b>	<b>156</b>	<b>240</b>	
<b>VULCAN 3P</b>	<b>Tractor PTO 3P</b>	<b>10 - 30</b>	<b>5 - 7</b>	<b>1,6 - 2"</b>	<b>2</b>	<b>6</b>	<b>122</b>	<b>269</b>	

Cod.	OPTIONAL	€
------	----------	---



**T**

*3 point hitch for tractor PTO  
Attelage à la prise de force du tracteur  
Anschluss an der Zapfwelle des Traktors  
Attacco alla PDF del trattore*

Cod.		€
------	--	---



**KP**

*Extension of ejection tube 1,80 m  
Rallonge du tuyau d'éjection 1,80 m  
Auswurfverlängerungsrohr 1,80 m  
Prolunga del tubo di scarico a h 1,80 m*

**DIMENSIONS - DIMENSIONS - ABMESSUNGEN - INGOMBRI**

Type	A (cm)	B (cm)	C (cm)
Vulcan	90	55	105

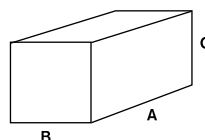

**PACKAGING - EMBALLAGE - VERPACKUNG - IMBALLAGGI**



- Box + Pallet
- Carton + Palette
- Box + Palette
- Scatola + Pallet



# Scutum

**Bio Shredder**  
**Broyeurs a vegetaux**  
**Holzhäcksler**  
**Biotrituratore**

Ø MAX cm 7 - 9 - inch 3



ENG

This bio shredder is both reliable and safe. It surpassed all the tests to assure the safety of the operator and assure the shredding performance with top marks.

FRA

Machine sûre, elle a depuis toujours dépassé toutes les essais et les contrôles qualité afin d'assurer au client final la sécurité et l'efficacité nécessaire pour un parfait broyage.

DEU

Dieser Bio Häcksler ist Zuverlässig und Sicher. Es hat alle Prüfungen zur Sicherheit des Bedieners und zur guter Häckselleistung mit gute Noten bestanden.

ITA

Macchina di assoluta affidabilità, ha superato con lode tutti i test effettuati per assicurare all'utente massima sicurezza ed efficacia nelle lavorazioni di triturazione.

## STANDARD FEATURES

- 1ST QUALITY STEEL FRAME, HIGH STRENGTH, ANTI VIBRATION, THICKNESS 5 MM LASER CUT, MACHINE BENT AND WELDED BY ROBOT
- "V" BELT TRANSMISSION SECTION B WITH TENSIONER
- ROTOR: FORCED VENTILATION, STEEL BEARING SUPPORTS, HIGHLY RESISTANT STEEL SHAFT
- 6 SWINGING REVERSIBLE HAMMERS AND 2 BLADES OF HIGHLY RESISTANT TEMPERED STEEL WITH QUICK REPLACEMENT SYSTEM, BALANCED ELECTRONICALLY
- 2 ADJUSTABLE COUNTER BLADES, EASILY REPLACEABLE.
- SELF CLEANING SCREEN WITH LONGITUDINAL SLOTS AND QUICK REMOVAL SYSTEM
- PNEUMATIC TIRES 330 MM DIAMETER
- PTO VERSION WITH CATEGORY 1, UNIVERSAL PTO SHAFT - 700 MM
- ENGINE VERSION: IT CAN BE SUPPLIED WITH HONDA GX270 OR GX390 ENGINE

## CARACTÉRISTIQUES STANDARD

- STRUCTURE EN ACIER DE HAUTE ÉPAISSEUR AU LASER DE 5 MM, PLIÉ ET SOUDÉ
- TRANSMISSION PAR COURROIE SECTION B AVEC TENDEUR À VIS
- ROTOR: VENTILATION FORCÉE, SUPPORTS ROULEMENTS EN ACIER, AXE EN ACIER
- ROTOR ÉQUILIBRÉ DE 6 MARTEAUX RÉVERSIBLES ET 2 LAMES EN ACIER TÉMPÉRÉ À HAUTE RÉSISTANCE TECHNIQUE AVEC SYSTÈME DE REMPLACEMENT RAPIDE ÉQUILIBRÉ ÉLECTRONIQUEMENT
- 2 CONTRE LAMES INTERCHANGEABLES REGLABLES POUR DETERMINER LA SECTION
- AUTONETTOYAGE AVEC TAMIS LONGITUDINAUX ET DÉMONTAGE RAPIDE DU SYSTÈME
- ROUES DE 330 MM DE DIAMÈTRE
- VERSION PTO AVEC CARDAN STANDARD 1° CATÉGORIE - 700 MM
- VERSION MOTEUR: FOURNI AVEC MOTEUR HONDA GX270 OU GX390

## STANDARD EIGENSCHAFTEN

- STAHLRAHMEN, ERSTE QUALITÄT, WIDERSTANDSFÄHIG, 5 MM DICK UM VIBRATIONEN ZU VERMEIDEN, WIRD MIT LASER GESCHNITTEN, AUTOMATISCH GEBOGEN UND MIT ROBOTER GESCHWEISST
- KEILRIEMEN ANTRIEB (QUERSCHNITT B) MIT VERSTELLBARER SPANNER
- ROTOR AUS HOCHLEISTUNG-STAHL MIT LÜFTUNG, KUGELLAGER IN GUSSEISEN HALTERUNGEN
- 6 REVERSIBLEN HÄMMERN UND ZWEI LEICHT AUSTAUCHBAREN, TEMPERIERTEN STAHLMESSERN, WERDEN ELEKTRONISCH AUSGEWUCHTET
- ZWEI LEICHT AUSTAUCHBARE UND VERSTELLBARE GEGEN-MESSER
- SELBSTREINIGENDES SIEB, SCHNELL AUSWECHSELBAR, MIT LÄNGSSCHLITZE
- PNEUMATIK REIFEN 330 MM DURCHMESSER
- PTO VERSION MIT KATEGORIE 1 GELENKWELLE - 700 MM
- MOTOR VERSION: LIEFERUNG ENTHÄLT HONDA MOTOR GX270 ODER GX390

## CARATTERISTICHE STANDARD

- STRUTTURA IN ACCIAIO DI PRIMA QUALITÀ, ALTA RESISTENZA, ANTI-VIBRAZIONI. SPESSORE 5 MM, TAGLIATO, PIEGATO E SALDATO CON MACCHINARI A CNC
- TRASMISSIONE A GINGHIA, SEZIONE B, CON TENDITORE A VITE
- ROTORE: VENTILAZIONE FORZATA, SUPPORTO CUSCINETTI IN ACCIAIO, ASSE IN ACCIAIO AD ALTA RESISTENZA
- DOTATO DI 6 MARTELLI, 2 COLTELLI IN ACCIAIO TEMPRATO AD ALTA RESISTENZA CON SISTEMA DI SOSTITUZIONE RAPIDA, BILANCIATO ELETTRONICAMENTE
- 2 CONTROCOLTELLI INTERCAMBIABILI A SEZIONE VARIABILE
- FUNZIONE DI AUTOPULIZIA CON SETACCI LONGITUDINALI
- RUOTE PNEUMATICHE PROFESSIONALI 330 MM DI DIAMETRO
- VERSIONE PTO CON CARDANO STANDARD 1° CATEGORIA - 700 MM
- VERSIONE MOTORE: FORNITO CON MOTORE HONDA GX270 O GX390

COD-MOD	version	hp	cm	in	n.	n.	kg	lbs	€
<b>SCUTUM GX 270</b>	<b>Honda GX 270</b>	<b>9</b>	<b>7 - 9</b>	<b>3"</b>	<b>2</b>	<b>6</b>	<b>145</b>	<b>320</b>	
<b>SCUTUM GX 390</b>	<b>Honda GX 390</b>	<b>13</b>	<b>7 - 9</b>	<b>3"</b>	<b>2</b>	<b>6</b>	<b>150</b>	<b>331</b>	
<b>SCUTUM 3P</b>	<b>Tractor PTO 3P</b>	<b>10 - 45</b>	<b>7 - 9</b>	<b>3"</b>	<b>2</b>	<b>6</b>	<b>150</b>	<b>331</b>	

Cod.	OPTIONAL	€
------	----------	---



**T**

3 point hitch for tractor PTO  
 Attelage à la prise de force du tracteur  
 Anschluss an der Zapfwelle des Traktors  
 Attacco alla PDF del trattore

Cod.		€
------	--	---



**KP**

Extension of ejection tube 1,80 m  
 Rallonge du tuyau d'éjection 1,80 m  
 Auswurfverlängerungsrohr 1,80 m  
 Prolunga del tubo di scarico a h 1,80 m

**DIMENSIONS - DIMENSIONS - ABMESSUNGEN - INGOMBRI**

Type	A (cm)	B (cm)	C (cm)
Scutum	110	55	120

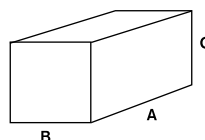

**PACKAGING - EMBALLAGE - VERPACKUNG - IMBALLAGGI**



- Box + Pallet
- Carton + Palette
- Box + Palette
- Scatola + Pallet

# Argo

## Bio Shredder

## Broyeurs a vegetaux

## Holzhäcksler

## Biotrituratore

Ø MAX cm 10 - inch 4



### ENG

A professional chipper/shredder with gravity-feed and high-level discharge. Reliability and safety are key elements of this machine.

### FRA

Broyeur à végétaux professionnel avec haut tube de déchargement. Confiance et sécurité sont les pont de force de cette machine.

### DEU

Ein Profi-Häcksler mit Manueller Holzeinzug und hohem Schnittgut-Auswurf. Zuverlässigkeit und Sicherheit sind die Hauptmerkmale dieser Maschine.

### ITA

Macchina di assoluta affidabilità, ha superato con lode tutti i test effettuati per assicurare all'utente massima sicurezza ed efficacia nelle lavorazioni di triturazione.

### STANDARD FEATURES

- HIGHLY RESISTANT STEEL FRAME, CUT, BENT AND WELDED BY ROBOT
- V BELT TRANSMISSION WITH 2 BELTS (SECTION B) WITH SCREW TENSIONER
- 3 POINT HITCH, CATEGORY 4 PTO SHAFT
- 4 REVERSIBLE CHIPPING BLADES OF HIGH RESISTANCE STEEL MOUNTED ON A VENTILATED DISC.
- QUICK ACCESS TO THE ROTOR FOR EASY BLADES REPLACEMENT.
- CHIPPER DISC HAS STEEL BEARING SUPPORTS AND IS ELECTRONICALLY BALANCED.
- SELF-FEED (GRAVITY) HOPPER, CHIPPING DISC PULLS BRANCHES IN AS IT CHIPS, MAX DIAMETER 110MM (4.5 INCH).
- MATERIAL DISCHARGE 1.5M (5 FOOT) HIGH AND 360° ADJUSTABLE

### CARACTÉRISTIQUES STANDARD

- STRUCTURE EN ACIER DE PREMIERE QUALITE, HAUTE RESISTANCE, PLIEE ET SOUDEE.
- TRANSMISSION PAR 2 COURROIES SECTION B AVEC TENDEUR A VIS
- ATTELAGE 3 POINT CARDAN CATEGORIE 4.
- DISQUE PORTE LAMES VENTILE AVEC SUPPORT EN ACIER, SUPPORT ROULEMENT ET AXE EN ACIER TEMPERE. EPAISSEUR DU DISQUE.
- 4 COUTEAUX REVERSIBLES EN ACIER TEMPERE AVEC SYSTEME DE DEMONTAGE RAPIDE, EQUILIBRE ELECTRONIQUEMENT. SYSTEME D'ACCES RAPIDE AU ROTOR.
- ALIMENTATION INDIPENDENT, AVEC PALETTES D'EVACUATION
- TUYAU D'EJECTION JUSQU'A 1,5M ET TOURNANT A 360°.
- DIAMETRE BROYABLE JUSQU'A





### STANDARD EIGENSCHAFTEN

- STAHLRAHMEN MIT HOHEM WIDERSTAND, VON ROBOTER GESCHNITTEN, GEBOGEN UND GESCHWEISST.
- ANTRIEB MIT 2 V-KEILRIEMEN (SEKTION B) MIT SCHRAUBSPANNER.
- 3-PUNKT-ANSCHLUSS, GELENKWELLE KATEGORIE 4.
- 4 UMKEHRBARE STAHLMESSER AUS HOCH WIDERSDTANDS STAHL AUF BELÜFTETE SCHEIBE MONTIERT.
- SCHNELLER ZUGANG ZU DEN ROTOR FÜR EINFACHER AUSTAUSCH DER MESSER.
- MESSER SCHEIBE HAT STAHL LAGERHALTERUNGEN UND WIRD ELEKTRONISCH AUSGEWUCHTET
- HOLZ (MAX. DIAMETER 110MM) WIRD MANUELL IM TRICHTER GETAN UND VON MESSERSCHEIBE EINGEZOGEN.
- AUSWURF 1,5M HOCH UND 360° EINSTELLBAR.

### CARATTERISTICHE STANDARD

- TELAIO IN ACCIAIO AD ALTA REISTENZA, TAGLIATO, PIEGATO E SALDATO DA ROBOT.
- TRASMISSIONE A 2 CINGHIE "V" (SEZIONE B) CON TENDITORE A VITE.
- ATTACCO A 3 PUNTI, CARDANO DI 4° CATEGORIA. 4 LAME REVERSIBILI IN ACCIAIO AD ALTA RESISTENZA MONTATE SU DISCO VENTILATO.
- ACCESSO RAPIDO AL ROTORE, FACILE SOSTITUZIONE DELLE LAME.
- ROTORE EQUILIBRATO ELETTRONICAMENTE MONTATO SU SUPPORTI IN ACCIAIO.
- ROTORE AUTOALIMENTATO CON SISTEMA DI VENTILAZIONE.
- SCARICO A 1,5M, REGOLABILE A 360°, DIAMETRO MASSIMO DI TAGLIO 110MM (4,5 POLLICI)



COD-MOD	version		hp						€
				cm	in	n.	kg	lbs	
<b>ARGO 3P</b>	<b>Direct Transmission</b>	-	20 - 80	10	4	4	215	474	
<b>ARGO 3P</b>	<b>Tractor PTO 3P</b>	2	20 - 80	10	4	4	215	474	

**DIMENSIONS - DIMENSIONS - ABMESSUNGEN - INGOMBRI**

Type	A (cm)	B (cm)	C (cm)
Argo	170	120	170

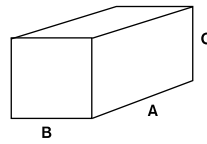

**PACKAGING - EMBALLAGE - VERPACKUNG - IMBALLAGGI**



- Pallet \_\_\_\_\_
- Palette \_\_\_\_\_
- Palette \_\_\_\_\_
- Pallet \_\_\_\_\_

# Scorpion

**Bio Shredder**  
**Broyeurs a vegetaux**  
**Holzhäcksler**  
**Biotrituratore**

Ø MAX cm 12-14 - inch 5



(ENG)

A professional chipper/shredder with high level discharge. A "No Stress" version is available which automatically adjusts the feed rollers to prevent the engine switching-off of the tractor. Reliability and safety are key elements of this machine.

## STANDARD FEATURES

- HIGHLY RESISTANT STEEL FRAME, CUT, BENT AND WELDED BY ROBOT
- V BELT TRANSMISSION WITH 2 BELTS (SECTION B) WITH SPRING LOADED TENSIONER
- VENTILATED HOLDER DISC, STEEL BEARING SUPPORTS, ROTOR SHAFT IN HIGH RESISTANCE STEEL, DISC 35 MM THICKNESS AND 500 MM DIAMETER
- QUICK ACCESS TO BLADE HOLDER FOR EASY BLADE REPLACEMENT
- 4 REVERSIBLE BLADES OF HIGH RESISTANCE STEEL
- INDEPENDENT HYDRAULIC SYSTEM. FEED ROLLER WITH INVERSION DEVICE AND SECURITY VALVE
- 3 POINT HITCH, CATEGORY 4 PTO SHAFT - 700 MM
- DISCHARGE 2 M HIGH AND ADJUSTABLE 360°. MAX WOOD CUT DIAMETER 140 MM (5 INCH.)

(FRA)

Broyeur à végétaux professionnel avec goulotte de 2 mètres orientable 360° de de chargement. La version "No Stress" est disponible et règle automatiquement le rouleau d'alimentation afin d'éviter l'arrêt du moteur du tracteur. Robustesse et sécurité sont les points de force de cette machine.

## CARACTÉRISTIQUES STANDARD

- STRUCTURE EN ACIER DE PREMIÈRE QUALITÉ, HAUTE RESISTENCE, COUPÉE, PLIÉE ET SOUDÉE AVEC MACHINES À CNC
- TRANSMISSION PAR 2 COURROIES SECTION B AVEC TENDEUR À RESSORT
- DISQUE PORTE LAMES VENTILÉ AVEC SUPPORTS EN ACIER, SUPPORT ROULEMENTS ET AXE EN ACIER TREMPÉ. ÉPAISSEUR DU DISQUE 35 MM, DIAMÈTRE 500 MM
- SYSTÈME D'ACCÈS RAPIDE AU DISQUE PORTE LAMES
- 4 COUTEAUX RÉVERSIBLES EN ACIER TREMPÉ AVEC SYSTÈME DE DÉMONTAGE RAPIDE, ÉQUILIBRÉ ÉLECTRONIQUEMENT.
- ATTELAGE 3 P. CARDAN CATÉGORIE 4 - 700 MM
- CIRCUIT HYDRAULIQUE INDÉPENDANT. ROULEAU D'ALIMENTATION HYDRAULIQUE, AVEC DISPOSITIF D'INVERSION ET VALVE DE SÉCURITÉ
- TUYAU D'ÉJECTION JUSQU'À 2 M ET TOURNANT À 360°. DIAMÈTRE DE COUPE JUSQU'À 140 MM

(DEU)

Ein Profi-Häcksler mit hydraulischer Zufuhr und hohen Auswurf. Eine "No Stress" Version mit automatischer Regelung der Einzugeschwindigkeit zur Vermeidung der Überlastung verfügbar. Zuverlässigkeit und Sicherheit sind hier an erster Stelle.

## STANDARD EIGENSCHAFTEN

- WIDERSTANDSFÄHIGER STAHLRAHMEN AUS ERSTER QUALITÄT, STAHL AUS HOHER RESISTENZ, WIRD MIT CNC MASCHINEN GESCHNITTEN, GEBOGEN UND GESCHWEISST
- ANTRIEB MIT 2 V-KEILRIEMEN (QUERSCHNITT N) MIT FEDER GESPANNT
- 4 REVERSIBLEN MESSERN AUS HOCHLEISTUNGSSTAHL SIND AN EINE GELÜFTETE SCHEIBE (35 MM DICK UND 500 MM DURCHMESSER) BEFESTIGT
- SCHELLZUGANG ZUR SCHEIBE FÜR SCHNELLEM MESSERWECHSEL
- DREIPUNKTBOCK MIT 4 HOCHLEISTUNGSSTAHL REVERSIBEL MESSERN AUSGESTATTET - 700 MM
- UNABHÄNGIGES HYDRAULIK SYSTEM. EINZUGSROLLE MIT UMKEHRFUNKTION UND SICHERHEITSVENTIL
- AUSWURF BIS 2M UND UM 360° DREHBAR. HOLZ DURCHMESSER BIS 140 MM

(ITA)

Biotrituratore professionale con alto tubo di scarico. È disponibile la versione "No Stress" che regola automaticamente il rullo di alimentazione al fine di prevenire lo spegnimento del motore del trattore. Affidabilità e sicurezza sono i punti forza di questa macchina.

## CARATTERISTICHE STANDARD

- STRUTTURA IN ACCIAIO DI PRIMA QUALITÀ, ALTA RESISTENZA, TAGLIATA, PIEGATA E SALDATA CON MACCHINARI A CNC
- TRASMISSIONE A 2 CINGHIE, SEZIONE B, CON TENDITORE A MOLLA
- DISCO PORTALAME VENTILATO, SUPPORTI CUSCINETTI IN ACCIAIO; ASSE IN ACCIAIO AD ALTA RESISTENZA. SPESSORE DEL DISCO 35 MM E DIAMETRO 500 MM
- SISTEMA DI ACCESSO RAPIDO AL DISCO PORTALAME
- DOTATO DI 4 COLTELLI REVERSIBILI IN ACCIAIO SPECIALE AD ALTA RESISTENZA
- ATTACCO A 3 PUNTI, CARDANO CATEGORIA 4 - 700 MM
- CIRCUITO IDRAULICO INDIPENDENTE. RULLO DI ALIMENTAZIONE IDRAULICO CON DISPOSITIVO DI INVERSIONE E VALVOLA DI SICUREZZA
- TUBO DI SCARICO FINO A 2 M, ORIENTABILE A 360°. DIAMETRO DI TAGLIO FINO A 140 MM

COD-MOD	NO STRESS SYSTEM	hp	cm	in	n.	kg	lbs	€
<b>Scorpion</b>	<b>NO</b>	<b>20 - 80</b>	<b>12</b>	<b>5"</b>	<b>4</b>	<b>380</b>	<b>838</b>	
<b>Scorpion NO STRESS</b>	<b>YES</b>	<b>20 - 80</b>	<b>12-14</b>	<b>5"</b>	<b>4</b>	<b>380</b>	<b>838</b>	

**DIMENSIONS - DIMENSIONS - ABMESSUNGEN - INGOMBRI**

Type	A (cm)	B (cm)	C (cm)
Scorpion	<b>180</b>	<b>130</b>	<b>145</b>
Scorpion NS	<b>180</b>	<b>130</b>	<b>145</b>

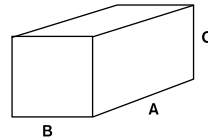

**PACKAGING - EMBALLAGE - VERPACKUNG - IMBALLAGGI**



- \_\_\_\_\_ Pallet
- \_\_\_\_\_ Palette
- \_\_\_\_\_ Palette
- \_\_\_\_\_ Pallet



# RES 10

**Back hoe**  
**Retropelle**  
**Dreipunkthydraulikbagger**  
**Retroescavatore**

**HP**  
**10 - 35**

**kW**

**8 - 25**

**rpm**

**540**

 cm 145 - inch 57



**ENG**

Technology, design and long life add value to this back hoe. It is a leader in the small and medium size digging equipment market from 10-35 HP.

**FRA**

Téchnologie, design, et durabilité sont les particularités de cette pelle rétro; la RES représente le leader incontesté dans la petite et moyenne gamme du marché de l'équipement du creusement pour des tracteur à partir de 10 jusqu'à 35 CV.

**DEU**

Technologie, Konzept und Langlebigkeit erhöhen den Wert dieser Heckbagger. Es ist führend im Markt von klein und mittel grossen Baggern von 10-35 PS.

**ITA**

Tecnologia, design e durata aggiungono valore a questo retroescavatore; leader incontrastato nel mondo della piccola e media movimentazione di terra, da 10 a 35 HP.

## STANDARD FEATURES

- 3 POINT HITCH, CATEGORY 1 AND 2
- PTO DRIVEN HYDRAULIC PUMP WITH GEARBOX FOR 540 RPM
- INDEPENDENT HYDRAULIC SYSTEM AND HYDRAULIC OIL TANK WITH 13 LITRES OIL CAPACITY
- 6 HYDRAULIC CYLINDERS
- ADJUSTABLE TILT SEAT
- DIGGING BUCKET MODEL EXL 25
- 3 POINT STABILIZER KIT STANDARD

## CARACTÉRISTIQUES STANDARD

- ATTELAGE À 3 POINTS 1° ET 2° CATÉGORIE
- POMPE À ENGRANAGES HYDRAULIQUE ACTIONNÉE PAR UNE PRISE DE FORCE DE 540 TOURS
- CAPACITÉ DU RÉSERVOIR D'HUILE HYDRAULIQUE 13 LITRES
- 6 VÉRINS HYDRAULIQUES
- SIÈGE EN POSITION RELEVÉE, RÉGLABLE ET INCLINABLE
- GODET D'EXCAVATION MODÈLE EXL 25
- DISPOSITIF STABILISATEUR DE SERIE

## STANDARD EIGENSCHAFTEN

- DREIPUNKTBOCK-ANSCHLUSS KATEGORIE 1 UND 2
- HYDRAULIKPUMPE VON ZAPFWELLE ANGETRIEBEN AUS ALUMINIUM MIT ÜBERSETZUNGSGETRIEBE 540 U/MIN
- EIGENSTÄNDIGER HYDRAULIKKREIS MIT HYDRAULIK-PUMPE UND HYDRAULIKÖLBEHÄLTER (13 LITER)
- 6 HYDRAULIKKOLBEN
- SITZ KIPPBAR UND EINSTELLBAR
- TIEFLÖFFEL MODELL EXL 25
- HECKBAGGERSTABILISATOR ENTHALTEN

## CARATTERISTICHE STANDARD

- ATTACCO A 3 PUNTI 1° E 2° CATEGORIA
- POMPA IDRAULICA AD INGRANAGGI AZIONATA DA PDF A 540 G/MIN.
- CAPACITÀ SERBATOIO OLIO 13 LITRI
- 6 CILINDRI IDRAULICI
- SEDILE POSIZIONE RIALZATA REGOLABILE E RIBALTABILE
- BENNA SCAVO MODELLO EXL 25
- DISPOSITIVO DI STABILIZZAZIONE DEL 3-PUNTO DIE SERIE

							
COD-MOD	hp		cm	in	kg	lbs	€
<b>RES 10</b>	<b>10 - 35</b>	<b>EXL 20</b>	<b>110</b>	<b>44"</b>	<b>246</b>	<b>542</b>	

Cod.	OPTIONAL	€
------	----------	---



**EXL**

*Digging bucket EXL 20 (included in the price)  
 Godet excavation EXL 20 (inclus dans le prix)  
 Tieflöffel mod. EXL 20 (im Preis enthalten)  
 Benna scavo EXL 20 (incluso nel prezzo)*

Cod.		€
------	--	---

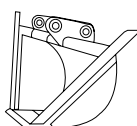

**TRL**

*Trapezoidal bucket TRL 60/2  
 Godet trapézoïdale TRL 60/2  
 Trapezlöffel mod. TRL 60/2  
 Benna trapezoidale TRL 60/2*

Cod.		€
------	--	---



**PFL**

*Trench cleaning bucket PFL 80  
 Godet de curage modèle PFL 80  
 Reinigungsöffel mod. PFL 80  
 Benna pulizia fossi modello PFL 80*

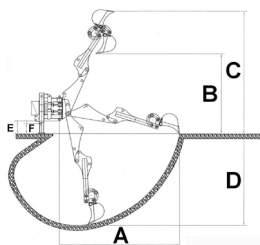

cm	RES 10
A	220
B	160
C	230
D	130
E	40
F	30

**DIMENSIONS - DIMENSIONS - ABMESSUNGEN - INGOMBRI**

Type	A (cm)	B (cm)	C (cm)
RES 10	120	80	180

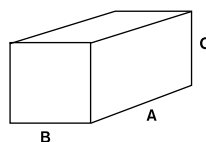

# RES 15 - 20 - 30

**Back hoe**  
**Retropelle**  
**Dreipunkthydraulikbagger**  
**Retroescavatore**

**HP**  
**15 - 60**

**kW**

**12 - 45**

**rpm**

**540**



**cm 130 - 155 - 180**  
**inch 52 - 61 - 71**



**ENG**

Technology, design and long-standing raise more value to the back hoe. It is a leader in a small and medium size digging equipment market from 15 to 60 HP.

**FRA**

Téchnologie, design, et durabilité sont les particularités de cette pelle rétro; la RES représente le leader incontesté dans la petite et moyenne gamme du marché de l'équipement du tracteur à partir de 15 jusqu'à 60 CV.

**DEU**

Technologie, Konzept und Langlebigkeit erhöhen den Wert dieser Heckbagger. Es ist führend im Markt von klein und mittel grossen Baggern von 15-60 PS.

**ITA**

Tecnologia, design e durata aggiungono valore a questo retroescavatore; leader incontrastato nel mondo della piccola e media movimentazione di terra, da 15 a 60 HP.

## STANDARD FEATURES

- 3 POINT HITCH, CATEGORY 1 AND 2, WITH STABILIZER KIT
- PTO DRIVEN HYDRAULIC PUMP WITH GEARBOX FOR 540 RPM
- DIGGING BUCKET MODEL EX 25 FOR RES 15 INCLUDED; EX 30 FOR RES 20 INCLUDED; EX 35 FOR RES 30 INCLUDED
- INDEPENDENT HYDRAULIC SYSTEM WITH PUMP AND HYDRAULIC OIL TANK
- 15 LITRES OF HYDRAULIC OIL, 7 HYDRAULIC CYLINDERS
- INDEPENDENT HYDRAULICALLY OPERATED STABILIZERS, SELF LUBRICATING BUSHINGS
- HARDENED PINS WITH INTERNAL LUBRICATION. SEAT TIPS FORWARD
- 3-POINT STABILIZER KIT STANDARD
- MANUAL SIDE-SHIFT WITH OPTIONAL HYDRAULIC LOCK (STANDARD FOR RES 30)

## CARACTÉRISTIQUES STANDARD

- ATTELAGE À 3 POINTS 1° ET 2° CATÉGORIE, AVEC PIEDS STABILISATEUR
- POMPE HYDRAULIQUE À ENGRANAGES ACTIONNÉE PAR UNE PRISE DE FORCE 540 TOURS
- GODET D'EXCAVATION MODÈLE EX 25 DE SERIE INCLUS; EX 30 POUR RES 20 INCLUS; EX 35 POUR RES 30 INCLUS
- CAPACITÉ DU RÉSERVOIR D'HUILE HYDRAULIQUE 15LITRES, 7 VÉRINS HYDRAULIQUES
- CIRCUIT HYDRAULIQUE INDÉPENDANT POUR LES PIEDS STABILISATEURS
- HAPES EN MATÉRIEL AUTO LUBRIFIANTES
- PIVOTS EN ACIER TEMPÉ AVEC GRAISSAGE EXTÉRIEUR
- DISPOSITIF STABILISATEUR DE SERIE
- BLOCAGE HYDRAULIQUE POUR DÉPLACEMENT LATÉRAL (RES 30) ET OPTION (RES 15 ET 20)
- SIÈGE EN POSITION RELEVÉE, RÉGLABLE ET INCLINABLE

## STANDARD EIGENSCHAFTEN

- DREIPUNKTBOCK-ANSCHLUß KATEGORIE 1 UND 2
- HYDRAULIKPUMPE AUS ALUMINIUM MIT ÜBERSETZUNGSGETRIEBE 540 U/MIN
- TIEFLÖFFEL MOD. EX 25 (IM PREIS ENTHALTEN) FÜR RES 15; EX 30 FÜR RES 20; EX 35 FÜR RES 30
- EIGENSTÄNDIGER HYDRAULIKKREIS MIT HYDRAULIK PUMPE UND HYDRAULIKÖLBEHÄLTER, 15 LT.
- 7 HYDRAULIKKOLBEN BUCHSEN AUS SELBSTSCHMIERENDEM MATERIAL MIT HOHEN WIDERSTAND
- GEHÄRTETE STAHLSTIFTE MIT INTERNER SCHMIERUNG
- HECKBAGGERSTABILISATOR ENTHALTEN
- SEITLICH VERSCHIEBBAR UND VORBEREITET FÜR EINBAU EINER HYDRAULIKFESTSTELLBREMSE FÜR SCHNELLERES ARBEITEN (STANDARD BEI RES 30)
- KIPPBAREN SITZ, AUSWAHL AN SCHAUFELN/LÖFFELN

## CARATTERISTICHE STANDARD

- ATTACCO A 3 PUNTI 1° E 2° CATEGORIA, CON BRACCI STABILIZZATORI
- POMPA IDRAULICA AD INGRANAGGI AZIONATA DA PDA A 540 G/MIN.
- BENNA SCAVO MOD. EX 25 DI SERIE PER RES 15; EX 30 DI SERIE PER RES 20; EX 35 DI SERIE PER RES 30
- CIRCUITO IDRAULICO INDIPENDENTE CON POMPA E SERBATOIO DELL'OLIO
- CAPACITÀ SERBATOIO OLIO 15 LITRI
- 7 CILINDRI IDRAULICI, BOCCOLE AUTOLUBRIFICANTI
- PERNI TEMPERATI CON LUBRIFICAZIONE INTERNA
- DISPOSITIVO DI STABILIZZAZIONE DEL 3-PUNTO DI SERIE
- BLOCCAGGIO IDRAULICO PER SPOSTAMENTO LATERALE STANDARD PER RES 30 E OPZIONE PER RES 15 E 20
- SEDILE POSIZIONE RIALZATA E RIBALTABILE





COD-MOD	hp		cm	in	kg	lbs	€
<b>RES 15</b>	15 - 60	<b>EX 25</b>	140	56"	349	769	
<b>RES 20</b>	15 - 60	<b>EX 30</b>	140	56"	380	838	
<b>RES 30</b>	15 - 60	<b>EX 35</b>	160	62"	415	915	

cod.	OPTIONAL	cod.	€
------	----------	------	---



**EX**

*Digging bucket  
Godet excavation  
Tiefloeffel  
Benna scavo*

EX 20

EX 25

EX 30

EX 35

EX 45

cod.		cod.	€
------	--	------	---

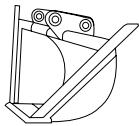

**TR**

*Trench cleaning bucket  
Godet trapézoidale  
Trapezloeffel  
Benna trapezoidale*

TR 60/2

TR 52/2.5

TR 60/2.5

cod.		cod.	€
------	--	------	---



**PF**

*Trench cleaning bucket  
Godet de curage  
Reinigungsloeffel  
Benna pulizia fossi*

PF 80

PF 100

PF 120

cod.		cod.	€
------	--	------	---

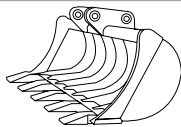

**GR**

*Wire bucket  
Godet grille  
Sortierloeffel  
Benna griglia*

GR 40

GR 50

GR 70

cod.		€
------	--	---

**BI**

*Hydraulic side - shift lock  
Blocage hydraulique du bras au châssis  
Hydraulische Verriegelung des Heckbaggerarms am Rahmen  
Bloccaggio idraulico del braccio escavatore al telaio*

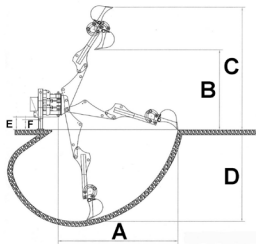

	15	20	30		15	20	30
A	220	234	254	D	130	155	180
B	165	180	200	E	40	40	40
C	250	275	300	F	30	30	30

**DIMENSIONS - DIMENSIONS - ABMESSUNGEN - INGOMBRI**

Type	A (cm)	B (cm)	C (cm)
<b>RES 15</b>	140	90	180
<b>RES 20</b>	150	90	180
<b>RES 30</b>	160	90	180

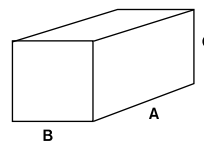

# DM 50

**Potato digger**  
**Arracheuse de pommes de terre**  
**Kartoffelroder**  
**Cavapatate**

**HP**  
**12 - 30**

kW

10 - 22

rpm

540

 cm 15 - 30 - inch 6 - 12



ENG

## STANDARD FEATURES

- 3 POINT HITCH, CATEGORY 1. DRIVE SHAFT AT 540 RPM
- 1 FIXED PLOWSHARE. OSCILLATING SIEVE SEPARATES POTATOES FROM SOIL
- ADJUSTABLE WHEELS FOR DEPTH CONTROL
- UNIVERSAL PTO SHAFT CATEGORY 1
- REAR DISCHARGE

FRA

## CARACTÉRISTIQUES STANDARD

- ATTELAGE À 3 POINTS CAT. 1, TRANSMISSION À 540 T/MIN
- 1 SOC FIXE, TAMIS OSCILLANT
- ROUES POUR RÉGLER LA PROFONDEUR DU TRAVAIL
- CARDAN UNIVERSEL CAT. 1
- ÉJECTION ARRIÈRE

DEU

## STANDARD EIGENSCHAFTEN

- DREIPUNKTBOCK-ANSCHLUSS KATEGORIE 1. ANTRIEBSWELLE MIT SCHWUNGRAD 540 U/MIN
- EINZEL SCHAR. OSZILLIERENDES UND VIBRIERENDES SIEB
- RÄDER FÜR DIE TIEFENREGULIERUNG
- STANDARD GELENKWELLE KATEGORIE 1
- HECKAUSWURF

ITA

## CARATTERISTICHE STANDARD

- ATTACCO A 3 PUNTI 1° CATEGORIA TRASMISSIONE A 540 G/MIN
- 1 VOMERE CURVO OSCILLANTE SETACCIO OSCILLANTE
- RUOTE PER LA REGOLAZIONE DELLA PROFONDITÀ DI LAVORO
- CARDANO UNIVERSALE 1° CATEGORIA
- SCARICO POSTERIORE



COD-MOD	hp	cm	in	cm	in	kg	lbs	€
DM 50	12 - 30	50	20"	90	36"	155	342	

## DIMENSIONS - DIMENSIONS - ABMESSUNGEN - INGOMBRI

Type	A (cm)	B (cm)	C (cm)
DM 50	140	90	100

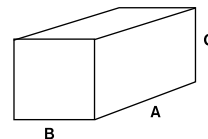

# DM 100

**Potato digger**  
**Arracheuse de pommes de terre**  
**Kartoffelroder**  
**Cavapatate**

**HP**  
**30 - 50**

**kW**

**22 - 40**

**rpm**

**540**

 cm 15 - 30 - inch 6 - 12



**ENG**

**STANDARD FEATURES**

- THREE-POINT HITCH, CATEGORY 1. DRIVE SHAFT WITH FLYWHEEL, 540 RPM
- STEEL FLYWHEEL. THREE INTERCHANGEABLE FURROWS
- OSCILLATING SIEVES SEPARATE POTATOES FROM SOIL
- ADJUSTABLE STEEL DISCS FOR DEPTH CONTROL
- UNIVERSAL PTO SHAFT CATEGORY 4
- SIDE DISCHARGE

**FRA**

**CARACTÉRISTIQUES STANDARD**

- ATTELAGE À 3 POINTS 1<sup>o</sup> CATÉGORIE TRANSMISSION À 540 T/MIN
- VOLANT EN ACIER. 3 SOCS INTERCHANGEABLES
- TAMIS OSCILLANTS
- DISQUES EN ACIER POUR RÉGLER LA PROFONDEUR DE TRAVAIL
- CARDAN 4<sup>o</sup> CATÉGORIE
- DECHARGEMENT LATÉRAL

**DEU**

**STANDARD EIGENSCHAFTEN**

- DREIPUNKTBOCKANSCHLUSS KATEGORIE 1. ANTRIEBSWELLE MIT SCHWUNGRAD 540 U/MIN
- SCHWUNGRAD AUS STAHL. 3 AUSTAUSCHBARE SCHAREN
- OSZILLIERENDEN SIEBEN
- STAHLSCHEIBEN FÜR TIEFENREGULIERUNG
- UNIVERSAL GELENKWELLE KATEGORIE 4
- SEITEN AUSWURF

**ITA**

**CARATTERISTICHE STANDARD**

- ATTACCO A 3 PUNTI 1<sup>o</sup> CATEGORIA TRASMISSIONE A 540 G/MIN.
- VOLANO IN ACCIAIO. 3 VOMERI INTERCAMBIABILI
- SETACCI OSCILLANTI
- DISCHI IN ACCIAIO PER LA REGOLAZIONE DELLA PROFONDITÀ DI LAVORO
- GIUNTO CARDANICO 4<sup>o</sup> CATEGORIA
- SCARICO LATERALE



COD-MOD	hp	cm	in	cm	in	kg	lbs	€
DM 100	30 - 50	60	24"	150	60"	305	762	

**DIMENSIONS - DIMENSIONS - ABMESSUNGEN - INGOMBRI**

Type	A (cm)	B (cm)	C (cm)
DM 100	160	170	105

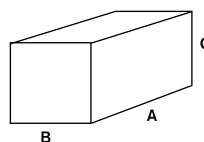





**Accessories 3 P**  
**Accessoires 3 P**  
**Zubehör 3 P**  
**Accessori 3 P**



**RM**

12 - 30 HP



**RM H**

12 - 30 HP



**CR 7**

12 - 30 HP



**CR**

12 - 30 HP



**CL**

12 - 30 HP



**CM**

30 - 140 HP



**BPO A**

12 - 30 HP



**BPO AR**

12 - 30 HP



**Various**  
**Divers**  
**Verschiedenes**  
**Varie**



**BEN**

15 - 40 HP



**RUL**

20 - 50 HP



# RM

**Reversible Plough**  
**Brabant reversible**  
**Volldrehpflug**  
**Aratro reversibile**

**HP**  
**12 - 30**

**kW**

**10 - 22**



cm 18 - 20  
 inch 7 - 8

ENG

## STANDARD FEATURES

- ADJUSTABLE 3 POINT HITCH CATEGORY 1
- PLOUGH SHARE BELLOTA MADE IN SPECIAL STEEL
- ADJUSTABLE TOOL CARRIER
- INTERCHANGEABLE SKIMCOULTERS
- DEPTH ADJUSTING WHEEL

FRA

## CARACTÉRISTIQUES STANDARD

- ATTELAGE 3 POINTS 1° CATÉGORIE
- SOCS BELLOTA EN ACIER IMPRIMÉ, INTERCHANGEABLES
- PORTE OUTILS RÉGLABLE
- RASETTE INTERCHANGEABLES
- ROUE DE PROFONDEUR

DEU

## STANDARD EIGENSCHAFTEN

- EINSTELLBARER DREIPUNKT AUFHÄNGUNG KATEGORIE 1
- BELLOTA SCHAREN AUS GESTANZTER STAHL, AUSWECHSELBAR
- EINACHSER WERKZEUGTRÄGER, VERSTELLBAR
- EINSTELLBARER UND AUSTAUSCHBARER PFLUGSCHAR
- RAD ZUR TIEFENREGULIERUNG

ITA

## CARATTERISTICHE STANDARD

- ATTACCO A 3 PUNTI 1° CATEGORIA
- VOMERI BELLOTA IN ACCIAIO STAMPATO, INTERCAMBIABILI
- PORTA ATTREZZI REGOLABILE
- AVANVOMERE INTERCAMBIABILE
- RUOTINO DI PROFONDITÀ

COD-MOD	hp	cm		in		kg		lbs	
		cm	in	cm	in	kg	lbs	kg	lbs
<b>MECHANICAL</b> <b>MECANIQUE</b> <b>MECHANISCH</b> <b>MECCANICO</b>	<b>RM 8</b>	12 - 30	20	8"	100	40"	90	198	
	<b>RM 10</b>	12 - 30	24	10"	110	44"	100	220	
	<b>RM 12</b>	12 - 30	26	12"	110	44"	110	242	

## DIMENSIONS - DIMENSIONS - ABMESSUNGEN - INGOMBRI

Type	A (cm)	B (cm)	C (cm)
RM 8	120	80	85
RM 10	120	80	95
RM 12	120	80	100

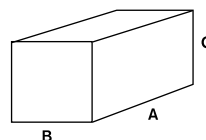

# RM H

**Reversible Plough**  
**Brabant reversible**  
**Volldrehpflug**  
**Aratro reversibile**

**HP**  
**12 - 30**

**kW**

**10 - 22**



 **cm 18 - 20**  
**inch 7 - 8**

**ENG**

**STANDARD FEATURES**

- ADJUSTABLE 3 POINT HITCH CATEGORY 1
- PLOUGH SHARE BELLOTA MADE IN SPECIAL STEEL
- ADJUSTABLE TOOL CARRIER
- INTERCHANGEABLE SKIMCOULTERS
- DEPTH ADJUSTING WHEEL

**FRA**

**CARACTÉRISTIQUES STANDARD**

- ATTELAGE 3 POINTS 1° CATÉGORIE
- SOCS BELLOTA EN ACIER IMPRIMÉ, INTERCHANGEABLES
- PORTE OUTILS RÉGLABLE
- RASETTE INTERCHANGEABLES
- ROUE DE PROFONDEUR

**DEU**





**STANDARD EIGENSCHAFTEN**

- EINSTELLBARER DREIPUNKT AUFHÄNGUNG KATEGORIE 1
- BELLOTA SCHAREN AUS GESTANZTER STAHL, AUSWECHSELBAR
- EINACHSER WERKZEUGTRÄGER, VERSTELLBAR
- EINSTELLBARER UND AUSTAUSCHBARER PFLUGSCHAR
- RAD ZUR TIEFENREGULIERUNG

**ITA**

**CARATTERISTICHE STANDARD**

- ATTACCO A 3 PUNTI 1° CATEGORIA
- VOMERI BELLOTA IN ACCIAIO STAMPATO, INTERCAMBIABILI
- PORTA ATTREZZI REGOLABILE
- AVANVOMERE INTERCAMBIABILE
- RUOTINO DI PROFONDITÀ

COD-MOD	hp								
		cm	in	cm	in	kg	lbs		
<b>H</b>	<b>RM 10 H</b>	12 - 30	24	10"	110	44"	120	265	
	<b>RM 12 H</b>	12 - 30	26	12"	110	44"	130	287	

**DIMENSIONS - DIMENSIONS - ABMESSUNGEN - INGOMBRI**

Type	A (cm)	B (cm)	C (cm)
RM 10	120	80	95
RM 12	120	80	100

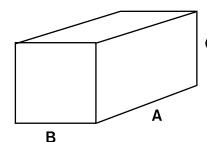

# CR 7

**Spring tine cultivator**  
**Cultivateur à ressort**  
**Feingrubber mit Federn**  
**Coltivatore a molle**

**HP**  
**12 - 30**

**kW**  
**10 - 22**



 cm 18 - 20  
 inch 7 - 8

ENG

**STANDARD FEATURES**

- 3 POINT HITCH, CATEGORY 1
- SPRINGS MADE OF SPECIAL STEEL
- WORKING DEPTH 18-20 CM

FRA

**STANDARD FEATURES**

- ATTELAGE 3 POINTS, 1° CATÉGORIE
- RESSORTS EN ACIER SPÉCIAL
- PROFONDEUR 18-20 CM

DEU





**STANDARD EIGENSCHAFTEN**

- DREIPUNKTBOCK-ANSCHLUB KATEGORIE 1
- FEDERN AUS SPEZIALSTAHL
- ARBEITSTIEFE 18-20 CM

ITA

**CARATTERISTICHE STANDARD**

- 3 PUNTI DI ATTACCO, 1° CATEGORIA
- MOLLE IN ACCIAIO SPECIALE
- PROFONDITÀ 18-20 CM

COD-MOD	hp					n.	 kg	 lbs
		cm	in	cm	in			
CR 7	12 - 30	100	40"	120	42"	7	90	198



# CR

**Spring tine cultivator with roller**  
**Cultivateur à ressorts avec rouleau**  
**Kulturregge mit Walze**  
**Coltivatore a molle con rullo**

**HP**

**12 - 40**

**kW**

**10 - 30**



cm 18 - 20  
inch 7 - 8

ENG

**STANDARD FEATURES**

- 3 POINT HITCH, CATEGORY 1
- SPRINGS MADE OF SPECIAL STEEL
- CAGE ROLLER INCLUDED
- ADJUSTABLE WORKING HEIGHT

FRA

**STANDARD FEATURES**

- ATTELAGE 3 POINTS, 1° CATÉGORIE
- RESSORTS EN ACIER SPÉCIAL
- ROULEAU CAGE INCLUS
- HAUTEUR DE TRAVAIL RÉGLABLE

DEU

**STANDARD EIGENSCHAFTEN**

- DREIPUNKTBOCK-ANSCHLUß KAT. 1
- FEDERN AUS SPEZIALSTAHL
- INKL. STABWALZE
- EINSTELLBARE ARBEITSHÖHE

ITA

**CARATTERISTICHE STANDARD**

- ATTACCO A 3 PUNTI, 1° CATEGORIA
- MOLLE IN ACCIAIO SPECIALE
- INCLUSO DI RULLO GABBIA
- ALTEZZA DI LAVORO REGOLABILE

COD-MOD	hp								€
		cm	in	cm	in				
<b>CR 9</b>	12 - 40	105	41"	110	43"	9	130	286	
<b>CR 11</b>	12 - 40	125	49"	130	51"	11	150	331	
<b>CR 13</b>	12 - 40	150	59"	155	59"	13	186	410	

ACCESSORIES - ACCESSOIRES - ZUBEHÖR - ACCESSORI

## RP

*Wheels to adjust depth*  
*Roues pour régler la profondeur*  
*Räder für Tiefen Regulierung*  
*Ruote per controllo profondità*

ACCESSORIES - ACCESSOIRES - ZUBEHÖR - ACCESSORI

## RV

*Adjustment of working height via lever*  
*Réglage des hauteurs de travail par levier*  
*Einstellung der Arbeitshöhe über Kurbel*  
*Regolazione delle altezze di lavoro tramite manopola*

# CL

**Tine cultivator tiller**  
**Cultivateur á dents**  
**Pflug mit Scharen**  
**Coltivatore a denti**

## HP

### 12 - 30

kW

10 - 22



 cm 18 - 20  
inch 7 - 8

ENG

#### STANDARD FEATURES

- 3 POINT HITCH, CATEGORY 1
- TINES MADE OF SPECIAL STEEL
- WORKING DEPTH 18-20 CM

FRA

#### CARACTÉRISTIQUES STANDARD

- ATTELAGE À 3 POINTS 1° CATÉGORIE
- SOCS REVERSIBLES EN ACIER SPÉCIAL
- PROFONDEUR 18-20 CM

DEU





#### STANDARD EIGENSCHAFTEN

- DREIPUNKTBOCK-ANSCHLUß KATEGORIE 1
- ZÄHNE AUS SPEZIALSTAHL
- ARBEITSTIEFE 18-20 CM

ITA

#### CARATTERISTICHE STANDARD

- ATTACCO A 3 PUNTI, 1° CATEGORIA
- VOMERI REVERSIBILI IN ACCIAIO SPECIALE
- PROFONDITÀ 18-20 CM

COD-MOD	hp							
		cm	in	cm	in			
CL 5	12 - 30	115	50"	115	50"	5	110	243
CL 7	12 - 30	165	60"	165	60"	7	140	309
CL 9	12 - 30	215	70"	215	70"	9	180	397

ACCESSORIES - ACCESSOIRES - ZUBEHÖR - ACCESSORI

## RP

*Wheels to adjust depth*  
*Roues pour régler la profondeur*  
*Räder für Tiefen Regulierung*  
*Ruote per controllo profondità*

# CM

**Tine cultivator tiller**  
**Cultivateur á dents**  
**Pflug mit Scharen**  
**Coltivatore a denti**

**HP**  
**30 - 140**

**kW**  
**22 - 100**



ENG

**STANDARD FEATURES**

- 3 POINT HITCH CATEGORY 1 AND 2
- TINES AND STEEL SPRINGS MADE OF SPECIAL STEEL
- REVERSIBLE PLOUGHSHARES

FRA

**CARACTÉRISTIQUES STANDARD**

- ATTELAGE Á 3 POINTS 1° ET 2° CATÉGORIE
- DENTS, RESSORTS ET SOCS EN ACIERS SPÉCIAUX
- SOCS RÉVERSIBLES

DEU

**STANDARD EIGENSCHAFTEN**

- DREIPUNKT-BOCK KATEGORIE 1 UND 2
- ZINKEN UND FEDERN AUS SPEZIALSTAHL
- UMKEHRBARE PFLUGSCHAREN

ITA

**CARATTERISTICHE STANDARD**

- ATTACCO A 3 PUNTI 1° E 2° CATEGORIA
- DENTI, VOMERI E MOLLE IN ACCIAIO SPECIALE
- VOMERI REVERSIBILI

COD-MOD	hp					dx-sx			
		cm	in	cm	in		kg	lbs	
<b>MEDIUM MOYEN MEDIUM MEDIO</b>	<b>CM 5</b>	30 - 70	125	49"	140	56"	5	152	335
	<b>CM 7</b>	30 - 70	175	69"	170	67"	7	199	439
	<b>CM 9</b>	30 - 70	225	88"	245	95"	9	262	578
	<b>CM 11</b>	30 - 70	250	98"	275	100"	11	320	705
<b>REINFORCED RENFORCÉE VERSTÄRKT RINFORZATO</b>	<b>CM R 11</b>	70 - 90	250	98"	275	109"	11	352	776
	<b>CM R 13</b>	70 - 90	295	116"	310	122"	13	404	891
<b>HEAVY LOURD SCHWER PESANTE</b>	<b>CP 7</b>	60 - 100	175	69"	190	76"	7	330	728
	<b>CP 9</b>	60 - 100	225	88"	245	97"	9	420	926
<b>REINFORCED RENFORCÉE VERSTÄRKT RINFORZATO</b>	<b>CP R 11</b>	100 - 140	275	108"	290	114"	11	530	1168
	<b>CP R 13</b>	100 - 140	325	128"	340	134"	13	625	1378

ACCESSORIES - ACCESSOIRES - ZUBEHÖR - ACCESSORI

# RP

*Wheels to adjust depth*  
*Roues pour régler la profondeur*  
*Räder für Tiefenregulierung*  
*Ruote per controllo profondità*

# BPO A

Potato digger with connecting bar  
 Arracheuse pomme de terre avec barre  
 Kartoffelroder mit Stange  
 Cavapatate con barra porta attrezzi

HP  
 12 - 30

kW

10 - 22



ENG

## STANDARD FEATURES

- COMPLETELY WELDED STEEL FRAME
- ELEMENTS: LASER CUT AND AUTOMATIC BENDING MACHINES WITH CNC CONTROL
- 2 OR 3 ELEMENTS WITH RELATED FLANGES; HIGHLY RESISTANT TEMPERED STEEL
- CATEGORY 1
- INTERCHANGEABLE ELEMENTS
- FLANGES TO ADJUST THE DISTANCE BETWEEN ELEMENTS
- ELECTROSTATIC COATING

FRA

## CARACTÉRISTIQUES STANDARD

- CHÂSSIS EN ACIER COMPLÈTEMENT SOUDÉ.
- ELÉMENTS: TÔLE COUPÉE AU LASER, PLIÉE À LA PRESSE NUMÉRIQUE ET SOUDÉE
- 2 OU 3 ÉLÉMENTS AVEC BRIDE ACIER HAUTE RÉSISTANCE
- ATTELAGE 1<sup>o</sup> CATÉGORIE
- ELÉMENTS INTERCHANGEABLES
- BRIDE POUR RÉGLAGE LATÉRAL DES ÉLÉMENTS
- PEINTURE ÉLECTROSTATIQUE À POUVRE

DEU

## STANDARD EIGENSCHAFTEN

- TOTAL GESCHWEISSTES STAHLFARHWERK
- BAUTEILE: LASERGESCHNITTENES BLECH, GEBOGEN DURCH EINE MASCHINE MIT NUMERISCHER STEUERUNG
- 2 ODER 3 BAUTEILE MIT SCHRAUBZWINGEN AUS HOCHWIDERSTANDSSTAHL
- ANSCHLUSS KATEGORIE 1
- AUSTAUSCHBARE BAUTEILE
- SCHRAUBZWINGEN ZUR REGELUNG DES ABSTANDS ZWISCHEN DEN BAUTEILEN
- ELEKTROSTATISCHES LACKIEREN

ITA

## CARATTERISTICHE STANDARD

- TELAIO IN ACCIAIO COMPLETAMENTE SALDATO
- ELEMENTI: LAMIERA TAGLIATA AL LASER E PIEGATA CON MACCHINA A CONTROLLO NUMERICO
- 2 O 3 ELEMENTI CON RELATIVE BRIDE, IN ACCIAIO AD ALTA RESISTENZA
- ATTACCO 1<sup>o</sup> CATEGORIA
- ELEMENTI INTERCAMBIABILI
- BRIDE PER REGOLARE LA DISTANZA TRA GLI ELEMENTI
- VERNICIATURA A POLVERE ELETTROSTATICA



COD-MOD		cm	in	kg	lbs	
<b>BPO A 2</b>	<i>Bar with 2 elements            Barre avec 2 elements            Stange mit 2 elemente            Barra con 2 elementi</i>	150	60	80	176	
<b>BPO A 3</b>	<i>Bar with 3 elements            Barre avec 3 elements            Stange mit 3 elemente            Barra con 3 elementi</i>	150	60	100	220	



# BPO AR

**Ridger with connecting bar**  
**Buttoir avec barre**  
**Furchenzieher mit Stange**  
**Assolcatore con barra porta attrezzi**

**HP**  
**12 - 30**

**kW**

**10 - 22**



**ENG**

**STANDARD FEATURES**

- COMPLETELY WELDED STEEL FRAME
- ELEMENTS: LASER CUT AND AUTOMATIC BENDING MACHINES WITH CNC CONTROL
- 2 OR 3 ELEMENTS WITH RELATED FLANGES; HIGHLY RESISTANT TEMPERED STEEL
- CATEGORY 1
- INTERCHANGEABLE ELEMENTS
- FLANGES TO ADJUST THE DISTANCE BETWEEN ELEMENTS
- ELECTROSTATIC COATING

**FRA**

**CARACTÉRISTIQUES STANDARD**

- CHÂSSIS EN ACIER COMPLÈTEMENT SOUDÉ.
- ELÉMENTS: TÔLE COUPÉE AU LASER, PLIÉE À LA PRESSE NUMÉRIQUE ET SOUDÉE
- 2 OU 3 ÉLÉMENTS AVEC BRIDE ACIER HAUTE RÉSISTANCE
- ATTELAGE 1° CATÉGORIE
- ELÉMENTS INTERCHANGEABLES
- BRIDE POUR RÉGLAGE LATÉRAL DES ÉLÉMENTS
- PEINTURE ÉLECTROSTATIQUE À POUVRE

**DEU**

**STANDARD EIGENSCHAFTEN**

- TOTAL GESCHWEISSTES STAHLFARHWERK
- BAUTEILE: LASERGESCHNITTENES BLECH, GEBOGEN DURCH EINE MASCHINE MIT NUMERISCHER STEUERUNG
- 2 ODER 3 BAUTEILE MIT SCHRAUBZWINGEN AUS HOCHWIDERSTANDSSTAHL
- ANSCHLUSS KATEGORIE 1
- AUSTAUSCHBARE BAUTEILE
- SCHRAUBZWINGEN ZUR REGELUNG DES ABSTANDS ZWISCHEN DEN TEILEN
- ELEKTROSTATISCHES LACKIEREN

**ITA**

**CARATTERISTICHE STANDARD**

- TELAIO IN ACCIAIO COMPLETAMENTE SALDATO
- ELEMENTI: LAMIERA TAGLIATA AL LASER E PIEGATA CON MACCHINA A CONTROLLO NUMERICO
- 2 O 3 ELEMENTI CON RELATIVE BRIDE, IN ACCIAIO AD ALTA RESISTENZA
- ATTACCO 1° CATEGORIA
- ELEMENTI INTERCAMBIABILI
- BRIDE PER REGOLARE LA DISTANZA TRA GLI ELEMENTI
- VERNICIATURA A POLVERE ELETTROSTATICA



COD-MOD		cm	in	kg	lbs
<b>BPO AR 2</b>	<i>Bar with 2 elements Barre avec 2 elements Stange mit 2 elemente Barra con 2 elementi</i>	150	60	80	176
<b>BPO AR 3</b>	<i>Bar with 3 elements Barre avec 3 elements Stange mit 3 elemente Barra con 3 elementi</i>	150	60	100	220

# BEN

**Dumper transport box**  
**Benne 3 p**  
**Kippbare Transport Box**  
**Cassoncino ribaltabile**

**HP**  
**15 - 40**

**kW**

**12 - 30**



**ENG**

## STANDARD FEATURES

- 3 POINT HITCH, CATEGORY 1
- SELF ASSEMBLED. REMOVABLE REAR WALL
- BLADE FOR LOADING IN REVERSE GEAR
- QUICK RELEASE FOR DUMPING
- CENTRAL PIVOT POINT

**FRA**

## CARACTÉRISTIQUES STANDARD

- ATTELAGE À 3 POINTS 1<sup>re</sup> CATÉGORIE
- LIVRAISON EN KIT DE MONTAGE. PORTE ARRIÈRE DÉMONTABLE
- LAME POUR CHARGEMENT EN MARCHÉ ARRIÈRE
- DÉCROCHEMENT COMMANDÉ PAR LEVIER
- BASCULEMENT CENTRAL

**DEU**

## STANDARD EIGENSCHAFTEN

- DREIPUNKTBOCK ANSCHLUSS KATEGORIE 1
- SELBSTMONTAGE. ABNEHMBARE RÜCKWAND
- PLANIERSCHILD ZUR LADUNG IM RÜCKWÄRTSGANG
- HEBEL BEDIENUNG FÜR KIPPVORGANG
- ZENTRALE KIPPLAGERUNG

**ITA**

## CARATTERISTICHE STANDARD

- ATTACCO A 3 PUNTI 1<sup>a</sup> CATEGORIA
- COMPLETAMENTE SMONTABILE. SPONDA POSTERIORE SMONTABILE
- LAMA PER CARICO IN RETROMARCIA
- SGANCIO CON COMANDO A LEVA
- BASCULAMENTO CENTRALE



## CAPACITY



COD-MOD	hp	DIMENSIONS		CAPACITY		WEIGHT	
		cm	in	kg	lbs	kg	lbs
<b>BEN 100</b>	15 - 40	100	39"	100	220	80	176
<b>BEN 120</b>	15 - 40	120	47"	100	220	85	187
<b>BEN 150</b>	15 - 40	150	60"	120	265	85	187

## DIMENSIONS - DIMENSIONS - ABMESSUNGEN - INGOMBRI

Type	A (cm)	B (cm)	C (cm)
<b>BEN 100</b>	110	90	30
<b>BEN 120</b>	130	90	30
<b>BEN 150</b>	150	90	30

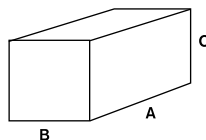

# RUL

**Roller compactor**  
**Rouleau compacteur**  
**Verdichter Walze**  
**Rullo compattatore**

**HP**  
**20 - 50**

**kW**

**15 - 40**



**ENG**

**STANDARD FEATURES**

- 3 POINT HITCH CATEGORY 1 AND 2
- SCRAPER TO CLEAN ROLL
- WATER TIGHT ROLLER FOR FILLING
- DIAMETER 400 MM

**FRA**

**CARACTÉRISTIQUES STANDARD**

- ATTELAGE À 3 POINTS 1° ET 2° CATÉGORIE
- LAME RACLEUSE POUR LE NETTOYAGE DU ROULEAU
- POSSIBILITÉ DE TESTER LE ROULEAU EN LE REMPLISSANT D'EAU
- DIAMÈTRE 400 MM

**DEU**

**STANDARD EIGENSCHAFTEN**

- DREIPUNKTBOCK-ANSCHLUß KATEGORIE 1 UND 2
- SCHMUTZABSTREIFER
- AUFFÜLLBAR MIT WASSER
- DURCHMESSER 400 MM

**ITA**

**CARATTERISTICHE STANDARD**

- ATTACCO A 3 PUNTI, 1° E 2° CATEGORIA
- RASCHIETTO PER LA PULIZIA DEL RULLO
- RULLO RIEMPIBILE A TENUTA
- DIAMETRO 400 MM

COD-MOD	hp						
		cm	in	cm	in	kg	lbs
<b>RUL 120</b>	20 - 50	120	47"	130	52	98	216
<b>RUL 150</b>	20 - 50	150	60"	160	64	110	243
<b>RUL 170</b>	20 - 50	170	68"	180	72	125	276

**DIMENSIONS - DIMENSIONS - ABMESSUNGEN - INGOMBRI**

Type	A (cm)	B (cm)	C (cm)
RUL 120	120	80	80
RUL 150	150	80	80
RUL 170	190	80	80

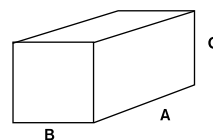

Photos, weights and dimensions of the machines showed on the price list are only indicative and they change on the basis of the different configurations. The machines and the spare parts are supplied at the following general terms.

DELIVERY	Ex-works
FREIGHT	The goods travel at customer's risk even if shipped free or with our trucks.
CLAIMS	Claims must be made within 8 days from the receipt of the goods by registered letter.
ACCESSORIES	The prices stated for the items on request refer to any accessory assembled at the origin.
PRICES	They can be changed anytime without any notice obligation.
VAT	At buyer's charge.
WARRANTY	Del Morino S.r.l. warranties all new machines of its production for 24 months after the buyer receives the product. The warranty consists in supplying the defective parts free of charge and it is granted after Del Morino has ascertained that malfunctions are due to production or material defects. Any modification made by the buyer to the machine, any irrational use, any carelessness of the operator CANCELS THE WARRANTY. PTO-shafts and bearings are excluded from this warranty as they follow the manufacturer's norms. In any case of parts replacement, labour and costs of freight are at buyer's charge. Del Morino S.r.l. declines any responsibility for any damage risen from breakage of parts of the machines and for any damage due to improper use of the same parts. Any defective part is invoiced at the shipment. In order to recognize the warranty, any defective part must be returned to us for examination. If after the part examination, the warranty claim is accepted, Del Morino will issue a credit note.
MODIFICATION	In order to improve the production, Del Morino S.r.l. reserves itself to make anytime any modification which deems more appropriate.
CONTROVERSY	For any controversy the competent forum is that of Arezzo.

Photos, poids et dimensions des machines présentes dans le catalogue sont purement indicatifs et changent selon les différentes configurations. Les machines et les pièces détachées sont fournies aux suivantes conditions générales de vente, qui sont acceptées par le client au moment de la confirmation de commande.

RENDU	Départ notre établissement Caprese Michelangelo Italie.
TRANSPORT	Les risques dérivant du transport sont à charge du commettant même si le matériel est expédié en franco de port ou avec notre camion.
RECLAMATIONS	Les réclamations devront parvenir par lettre recommandée, à nos bureaux, dans les 8 jours suivants la réception du matériel.
ACCESSOIRES	Les prix indiqués pour les pièces sur demande sont référés aux accessoires montés à l'origine.
PRIX	Les prix pourront subir modifications sans nécessité de préavis.
TVA	À la charge de l'acheteur.
GARANTIE	Les machines Del Morino sont garanties, fournies neuves, pour 24 mois de la livraison. La garantie consiste en expédition gratuite de la pièce défectueuse et sera accordée après la vérification que la casse se soit vérifiée par défaut de fabrication ou de qualité de matériel. Les modifications apportées à la machine par l'acheteur, l'emploi irrationnel, la négligence de l'utilisateur (manque de graissage), ANNULENT LA GARANTIE. Les cardans de transmission et les roulements ne sont pas compris dans notre garantie puisqu'ils suivent les règlements des maisons constructrices. Dans tous les cas, restent à charge de l'acheteur les frais de remplacement du matériel d'usure, la main d'oeuvre et les frais de port. La Del Morino décline toute responsabilité pour dommages directs ou indirects, causés par casse de parties de la machine, et pour dommages dérivants d'un emploi impropre de la machine. Pour motivations d'organisation, toutes les pièces seront facturées au moment de l'expédition. L'éventuelle reconnaissance de la garantie, suite à réception et vérification de la pièce défectueuse, donnera le droit à recevoir une note de crédit.
MODIFICATIONS	La Del Morino se réserve le droit d'apporter toute modification à ses machines dans le but d'améliorer sa production.
CONTROVERSE	Pour chaque controverse le tribunal compétant est celui d'Arezzo.



Die angegebenen fotos, gewichte und abmessungen der preisliste sind indikativ und können bei unterschiedliche konfigurationen variieren. Die Maschinen und Ersatzteile werden von uns unter den folgenden allgemeinen Konditionen geliefert. Der Kunde akzeptiert diese Konditionen automatisch, wenn er einen Auftrag erteilt.

ÜBERGABE	Ab Werk in Caprese Michelangelo.
TRANSPORT	Das Risiko des Warentransportes liegt beim Kunden, auch wenn sie frei oder in unseren Lieferwagen transportiert wird.
BEANSTANDUNGEN	Beanstandungen müssen innerhalb von 8 Tagen ab Wareneingang in Form eines Briefs geltend gemacht werden.
AUSSTATTUNG	Die Preise für Sonderausstattung und Zubehör gelten nur für die von uns montierten Teile.
PREISE	Können von uns jederzeit, ohne Pflicht einer diesbezüglichen Ankündigung, verändert werden.
MWST	Ist nicht im Preis enthalten.
GARANTIE	Die Firma Del Morino S.r.l. gibt auf Anbaugeräten aus eigener Fertigung eine Garantie von 24 Monaten ab Auslieferung. Die Garantie beinhaltet die kostenlose Lieferung von Teilen, die als defekt anerkannt werden, Konstruktions- oder Materialfehler mit Ausschluss der kosten für Verbrauchsmaterial, Arbeitszeit und Transport. Alle Veränderungen, die seitens des Käufers an der Maschine vorgenommen werden, eine unangemessene Verwendung der Maschine, und Nachlässigkeit des Nutzers (Nichtbeachtung der Benutzungs- und Instandhaltungsbestimmungen, die in dem Handbuch ausgewiesen werden) LASSEN DIE GARANTIE ERLÖSCHEN. Gelenkwellen und Lager sind von dieser Garantie ausgeschlossen, da sie den Standards des Herstellers entsprechen. Del Morino S.r.l. lehnt jede Verantwortung ab, die für direkte oder indirekte Schäden, die aus unsachgemäßer Nutzung der Maschine oder Bruch einzelner Maschinenteile entstehen.
ÄNDERUNG	Die Firma, immer auf der Suche nach Verbesserung der eigenen Produktion, behält sich das Recht vor, jederzeit Änderungen vorzunehmen, die sie für not endig hält.
KONTROVERSE	Für jeden echtsstreit ist der erichtsstand Arezzo, Italien.

Foto, pesi e dimensioni delle macchine presenti nel listino sono puramente indicativi e variano in base alle diverse configurazioni. Le macchine e le parti di ricambio, vengono da noi fornite alle seguenti condizioni generali, la cui accettazione da parte dei clienti è implicita nel conferimento degli ordini relativi.

RESA	Franco nostro stabilimento di Caprese Michelangelo.
TRASPORTO	La merce viaggia a rischio e pericolo del committente anche se spedita in porto franco o con nostro automezzo.
RECLAMI	Dovranno essere effettuati entro 8 giorni dal ricevimento della merce a mezzo di lettera raccomandata.
ACCESSORI	I prezzi indicati per le voci a richiesta, si intendono solo per accessori montati all'origine.
PREZZI	Potranno essere da noi variati in qualsiasi momento, senza l'obbligo di preavviso.
IVA	A carico dell'acquirente.
GARANZIA	La ditta Del Morino S.r.l. garantisce le macchine di propria fabbricazione, fornite nuove, per un periodo di 24 mesi dalla consegna. La garanzia consiste nella fornitura gratuita del pezzo, riconosciuto difettoso, per difetto di costruzione o di materiale con l'esclusione delle spese relative al materiale di consumo, alla manodopera e al trasporto. Tutte le modifiche apportate alla macchina da parte dell'acquirente, l'impiego al di sopra delle caratteristiche tecniche rico-nosciute alla macchina dalla stessa Del Morino S.r.l., e l'incuria dell'utente (inosservanza delle disposizioni per l'utilizzo e la manutenzione, indicate all'interno del manuale uso e manutenzione della macchina), ANNULLANO LA GARANZIA. Le trasmissioni cardaniche ed i cuscinetti sono esclusi dalla presente garanzia in quanto seguono le norme delle ditte costruttrici. Del Morino S.r.l. declina ogni responsabilità per danni diretti ed indiretti derivanti dall'uso improprio del mezzo o da rotture di componenti della macchina.
MODIFICHE	La ditta al costante impegno di migliorare la propria produzione, si riserva di apportare in qualsiasi momento, le modifiche che riterrà più opportune.
CONTROVERSIE	Per qualsiasi controversia, è competente il foro di Arezzo.



A series of horizontal dotted lines spanning the width of the page, providing a template for writing or drawing.













Del Morino

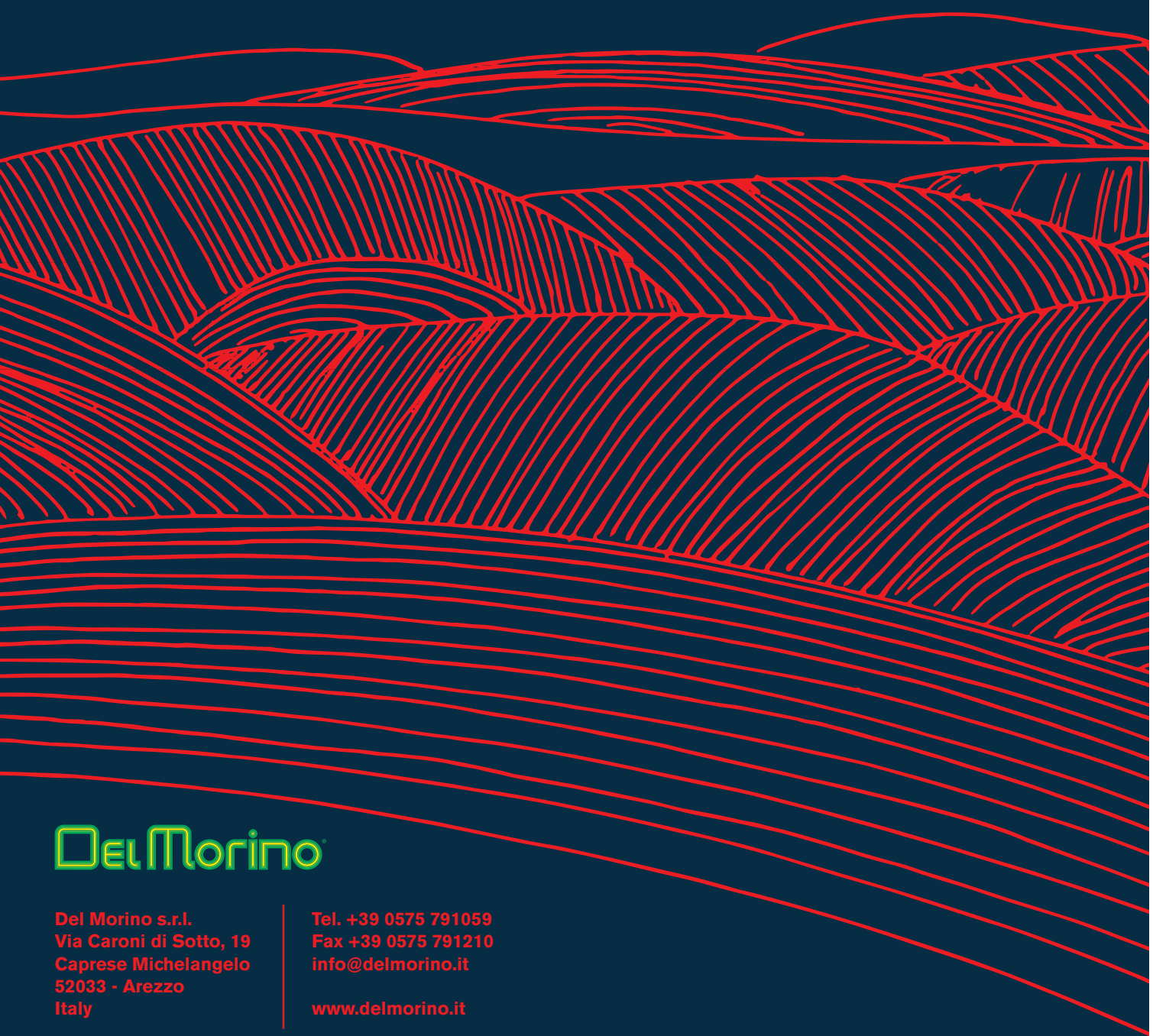

Del Morino

Del Morino s.r.l.  
Via Caroni di Sotto, 19  
Caprese Michelangelo  
52033 - Arezzo  
Italy

Tel. +39 0575 791059  
Fax +39 0575 791210  
info@delmorino.it  
www.delmorino.it