



Operations & Parts Manual

For Models:

- BE-SBS5054G
- BE-SBS6066G
- BE-SBS6670G
- BE-SBS7276G
- BE-SBS7680G
- BE-SBS8488G

Purchase Date	Model No.	Serial No.
Dealer		

1. Be sure all exposed moving parts such as shafts and adapters are properly guarded and that all coupling devices are securely attached before applying power. Do not use unless all shields are in place.
2. Do not wear loose fitting clothing in the vicinity of any moving parts.
3. Do not exceed recommended ground speed, recommended PTO speed or recommended horsepower for the unit which you are using.
4. Keep all persons, pets and livestock away from unit when in use.
5. Do not turn discharge chute towards persons, pets, livestock or buildings when blower is in operation.
6. Before working on, servicing or making adjustments to equipment, disengage power, lower unit to ground level, shut off engine, make sure all moving parts have stopped and all pressure in the hydraulic system is relieved.
7. Do not attempt to remove any obstruction from discharge chute until PTO is disengaged and engine is shut off.
8. Do not stand on auger to service any part of blower, as auger may turn causing either, a serious fall; or the blower fan to rotate, presenting a danger to fingers, hands or arms in the chute assembly or blower housing.
9. Keep hands and arms away from cables and turner bar of hydraulic hood turner until engine is shut off.
10. Always look to the rear before backing up.
11. Be aware of the presence of people and objects that may be obscured from vision by blowing or drifted snow. Be certain that no children have tunneled into snowbanks which are to be removed. Never let children slide down snowbanks in the vicinity of an operating blower.



Colour: Red
Location: Blower Side
 Stones or other objects may be thrown great distances by the auger, especially at higher RPM. Do not stand in front of the blower when it is in operation.

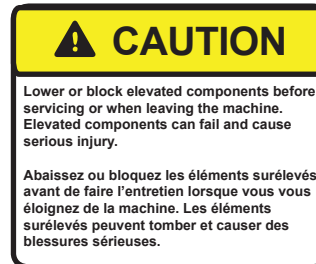

Colour: Yellow
Location: Blower Back
 Do not service, adjust or repair any equipment attached to the 3PT hitch hydraulic, without lowering the unit to the ground. If work must be performed underneath the unit, block the unit in a raised position.

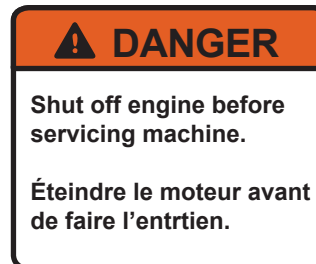

Colour: Orange
Location: Blower Back
 Do not attempt any servicing of the blower while the tractor engine is running. If the tractor PTO is accidentally engaged the serviceman could become entangled in moving parts and seriously injured or killed. Be certain. Be safe. Shut off the engine.

Any debris or stones which are swept into the fan can be thrown at great distances. Do not allow any bystanders to stand in the path of the discharge chute.

Shields are supplied for your protection. Do not remove shield and do not operate the machine unless all shields are in place.

Do not service, adjust or repair until the PTO has been disengaged, the motor shut off, the unit lowered to the ground and all parts have stopped moving. Any moving part has the possibility of entangling the operator or his clothing and causing serious injury, dismemberment or death.



Colour: Red
Location: PTO Shaft
 Never go near any moving parts. Because tractor PTO may be accidentally engaged, Repair or couple PTO unless tractor engine is shut off. Do not remove shields. Be sure that PTO shield turns freely and independently of the driveline. Do not operate unless all shields are in place. Be sure that PTO shaft is attached securely at both ends before operating.

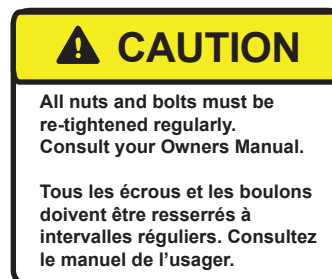

Colour: Yellow
Location: Blower Back
 Every effort is made to ensure that a well constructed high quality product leaves the manufacturer. Again the dealer inspects and services each unit before it leaves his lot.

To keep your blower in good operating condition, please inspect and re-tighten as necessary any loose nuts or studs after a half hour break in period. Thereafter periodic checks will ensure that your blower remains in top working condition.



Colour: Red
Location: Blower Side



Colour: Orange
Location: Blower Side

1. Turn hood to point directly behind blower (PTO side).
2. Lift hood assembly off and spread a light coat of grease on outside of blower mainframe pipe.
3. Replace hood assembly.
4. Install hood turner as per instructions.
5. Grease shear assembly, auger bearings and hydraulic hood turner if installed.
6. Check oil level in gear box.
7. Check all bolts for tightness.
8. Check auger drive chain tension and alignment.
9. Grease PTO universal joints, shield retaining collars and inner tube of PTO.

OPERATION

1. When attaching the blower make certain all guards are in place.
2. Ensure that the fan and auger rotate freely before connecting PTO shaft to the tractor.
3. Use proper pins and ensure that all connections are secure.
4. Engage the PTO at low engine RPM and slowly increase speed to operate level. Operating speed will vary with snow, weather and ground conditions.
5. Adjust the top link of the 3PT hitch to match the ground and snow conditions. Increasing the length will cause the blower to cut deeper into compacted snow, but may also cause the blower to scrape gravel or stones into the fan, which can be a danger to nearby persons, pets, livestock or buildings. Decreasing the length of the top link causes the blower to ride back on the skid shoes, raising the cutting height, thereby reducing the possibility of scraping gravel or stones into the blower.
6. Adjust the deflector for the distance of throw required. Moving the adjusting bar, to shorten the distance between the pins increases the throw.
7. Be aware of the presence of people and objects that may be obscured from vision by blowing or drifted snow. Be certain that no children have tunneled into snowbanks which are to be removed. Never let children slide down snowbank in the vicinity of an operating blower.

SERVICE

1. Before servicing or adjusting, disengage the PTO, lower the unit to the ground and shut off engine.
2. To prevent freezing of hood or other moving parts apply a solution of antifreeze or light oil.
3. Check gearbox oil level on a regular basis. If oil level is low, use a good quality 80W-90 gear oil.
Change oil after 50 hours during break-in period. Change after 700-750 hours or yearly.
4. Grease the shear assembly and hydraulic hood turner every five hours of operation.
5. Grease the auger bearings every ten hours of operation.
6. Check auger drive chain tension and alignment. Adjust if necessary.

A proper initial installation will give you years of satisfactory service on your equipment. Please read carefully following instructions which have been specially made to help you and make you satisfied with your purchase.



WARNING!

Unfortunately, snowblowers will be faced with forgotten or hidden objects under the snow, such as chain, tires, stones, pieces of wood, etc. In spite of all our efforts, machines are not built to resist all those conditions.

DANGER!

It is dangerous to use a tractor which is too big or too powerful. The tractor will always be able to overload the blower, even if the machine is already at maximum capacity. Tractor being very high, too large angles at PTO universal joints will result and life of universal joints will be shortened dramatically.

PTO SHAFT ANGLES

PTO Shafts are made to transmit power with angles at universal joints. However, these angles should be kept to a minimum. Larger the angle, shorter the life of PTO. For example a snowblower sold for a tractor capacity of 60-70 HP, which would be attached to a 60 HP Tractor, operating at maximum capacity (60 HP Continuous).

HP	PTO ANGLES	ESTIMATED LIFE (HOURS)	F FACTOR	ANGLE
60 @ 540 RPM	5°	450 Hours	6	10°
Using #50 PTO	10°	195 Hours	3.75	15°
	15°	90 Hours	2.75	20°
	20°	40 Hours	2.15	25°
	25°	20 Hours	1.75	30°

HOW TO DETERMINE PTO ANGLE

- 1) Lower blower on ground
- 2) Take measures A, B and L
- 3) Subtract B of A ($A-B=C$)
- 4) Divide L by C ($L/C=F$)
- 5) Compare F factor in table to find PTO angle (interpolate, if necessary).

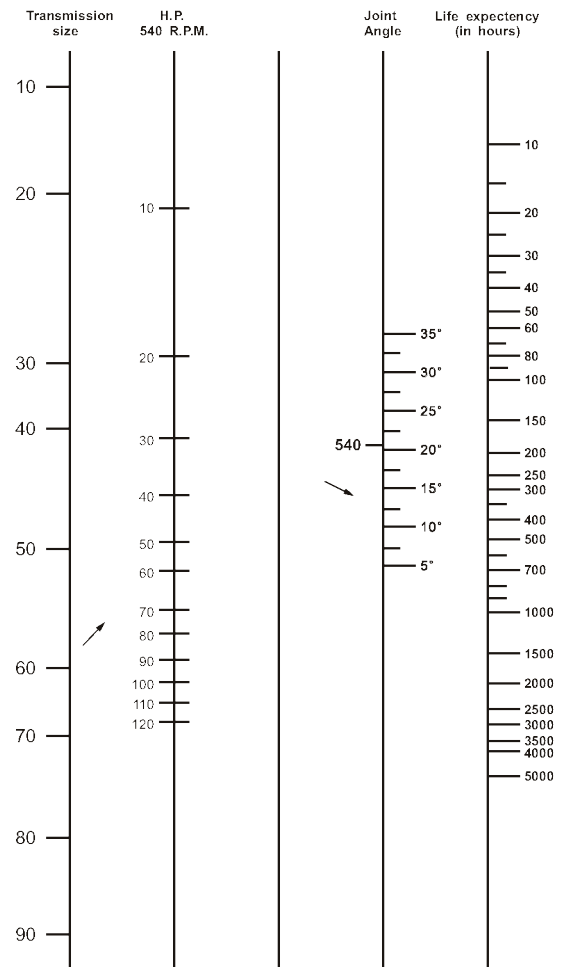
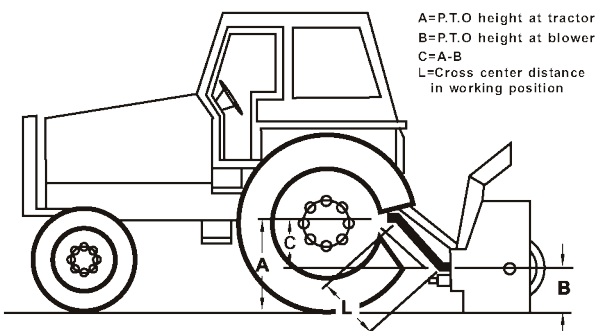

EX: Transmission size 60 for 60 H.P. @ 540 R.P.M. with joint angle of 10° will have an expected life of 670 hours.

This table is valid only for 540 R.P.M.

Previous examples clearly demonstrate that universal joint angle is directly related with life of PTO in order to reduce angle, it is necessary to increase the distance between snowblower and tractor.

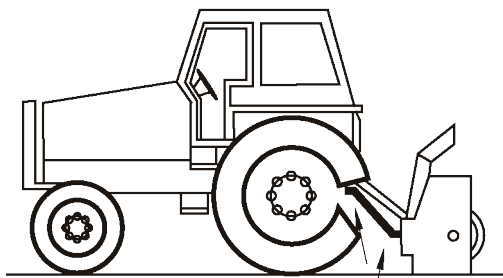

AVOID
Too Large Angles at P.T.O. Joints

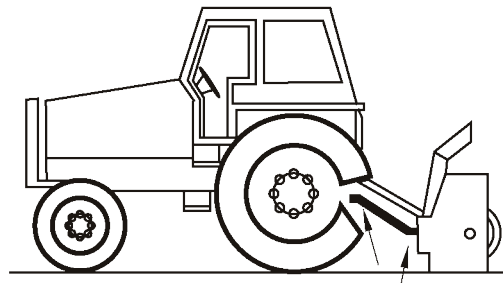

ACCEPTABLE
Reasonable Angles at P.T.O. Joints

It is impossible to increase the distance between snowblower and tractor, in order to maintain a reasonable angle at PTO, it is recommended to use a large size of PTO, That is a greater capacity PTO, (please refer to your dealer for more details).

For snowblowers of 100 HP an additional gearbox is also available that can be mounted on existing snowblower gear box, which increased the input shaft height, reducing angle at PTO joints. This gear box also has a an input speed of 1000 RPM, which greatly increases PTO capacity.

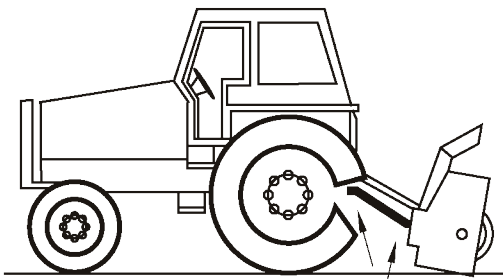

AVOID
Non-Equal Angles at P.T.O. Joints

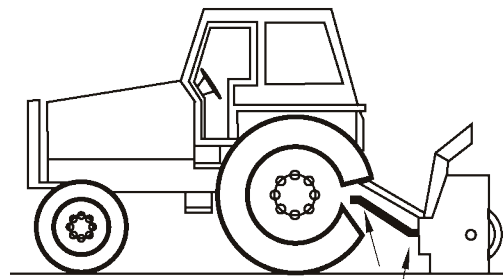

ACCEPTABLE
Equal Angles at P.T.O Joints

ANGLES AT EACH END OF PTO

A popular habit is to change snowblower angle in order to obtain a better scraping effect. This practice can become harmful to the PTO, angle at each end being unequal. There will be a fan speed variation as well as a drastic increase of load on cross and bearings. To avoid, it is recommended to keep tractor PTO Shaft and snowblower input shaft always parallel.

SHEAR BOLTS

Shear bolts are built to break under shocks on the fan or on the auger. However, under certain circumstances, this security is not adequate. Example: a sudden high impact shock on the fan may, in some cases, break the fan shaft without breaking the shear bolt.

If the shear bolt breaks, make sure to always replace it with a same category bolt (grade 8.8). It is necessary to always maintain this bolt very tight, in order to keep the efficiency of the shearing mechanism.

WARNING: The gear box fan shafts are made with special allow steel. Moreover, they are case hardened to increase capacity to shock load. These shafts cannot be broken under normal snow loads. However, undesirable objects may enter the fan and either bend or break gear box shaft. It is understood that gear box cannot be built to resist every possible overloads and consequently, gear box fan shafts will not be replaced under warranty. Therefore, the user of the snowblower must be very careful.

1. Un-crate items and compare with the parts breakdown found in the Operator's Manual.
2. Bolt on left and right skid shoes according to Image 1.
3. Assemble the chute. Following manner of assembly in Image 2 and Image 3. Refer to the snowblower diagram in the diagram in the operator's manual for exploded view.



Image 1: Assembled Skid Shoe.

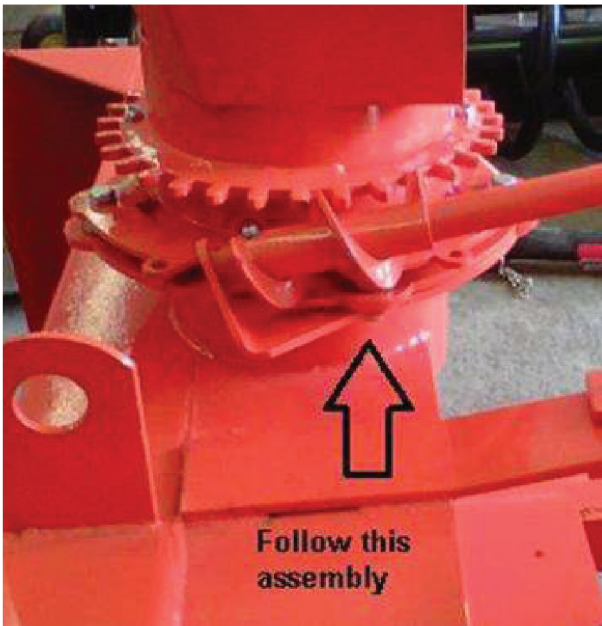

Image 2: Chute Assembly.

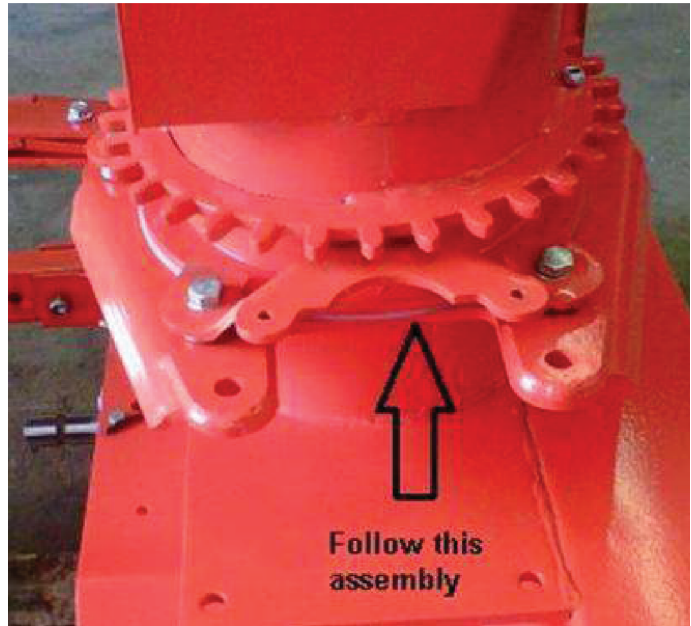

Image 3: Chute Assembly.

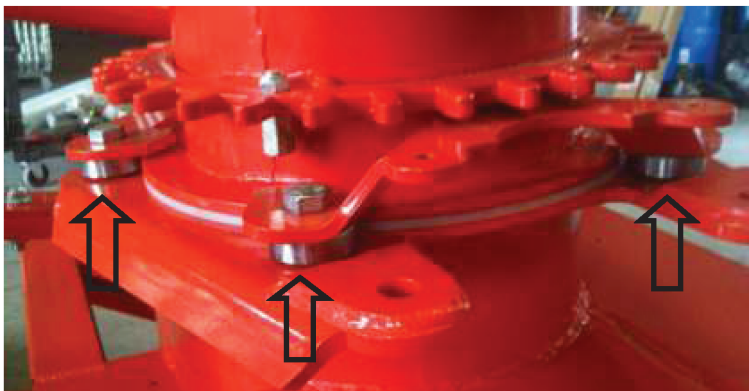

Image 4: Chute Bearing.

Note: Shims (#24 in parts list) for bearings must be installed on the top bottom of bearings.

The bolts must be oriented with the threads down, see Image 4.

4. Assemble hitch, see Image 6.
5. Assemble the hitch top assembly and chute crank support brackets as shown in image 7.
6. Refer to page 2 of the operator's manual for final service and installation of snowblower.



Image 5: Crank Support Bracket

Note: Hand crank support bracket must be installed on the bottom of chute flange.

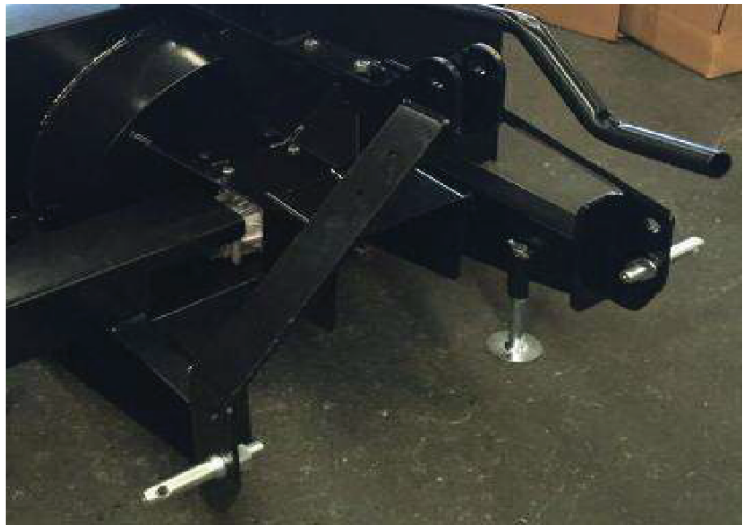
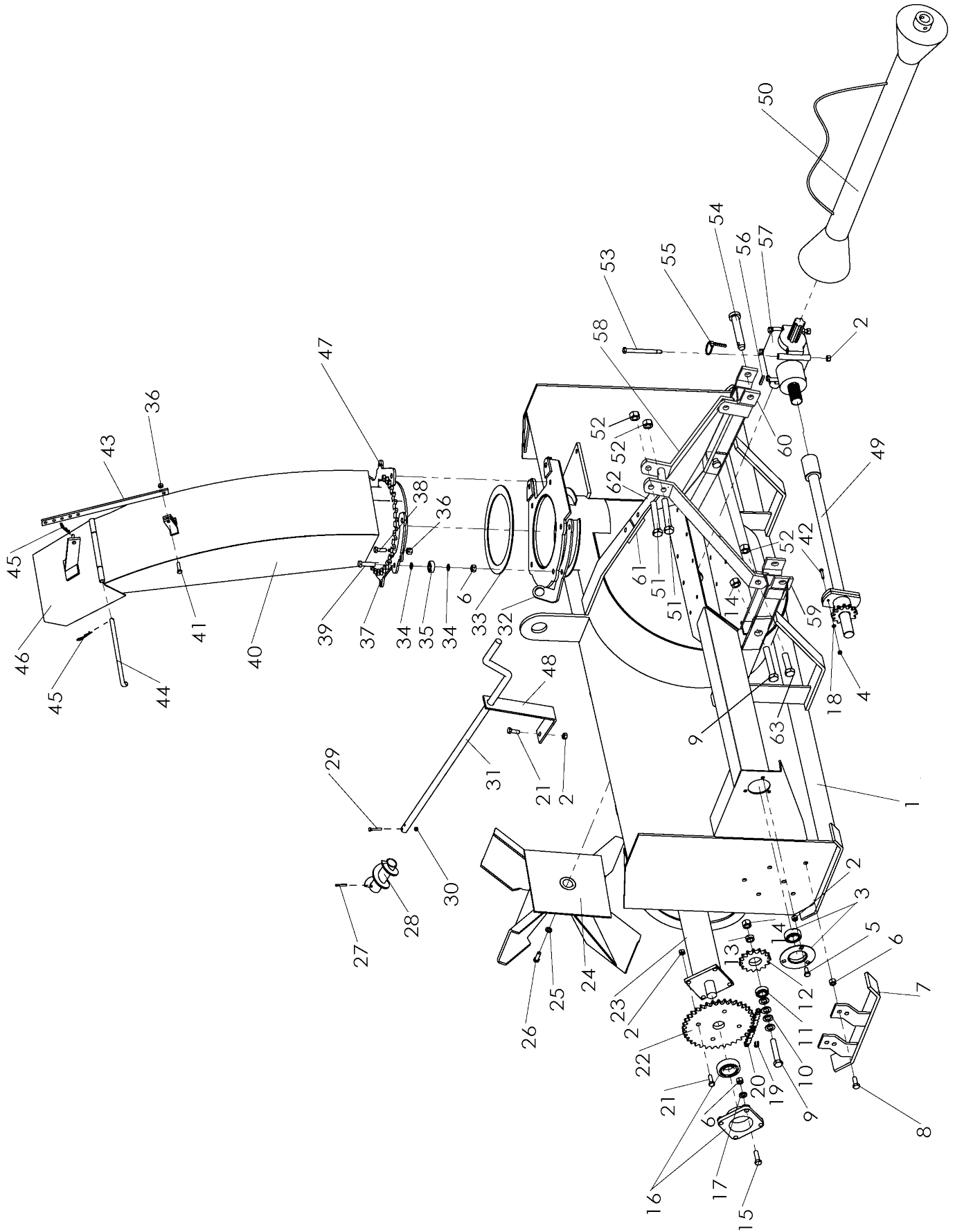

Image 6: Hitch Frame



Image 7: A Frame Top Assembly



SNOWBLOWER PARTS LIST

BE-SBSxxxxG

REF NO.	PART NO.	DESCRIPTION	QTY
1	130001	Main Frame	1
2	130002	Lock Nut M10	13
3	130003	Bearing SAPF-206-20 C/W Flange	1
4	130004	Nut M6	1
5	130005	Bolt M10x20	3
6	130006	Lock Nut M12	17
7	130007	Skid Plate	2
8	130008	Bolt M12x30	4
9	130009	Bolt M16x90	3
10	130010	Washer 16	4
11	130011	Bearing 6203-2RS.5/8	1
12	130012	Idler Sprocket	1
13	130013	Spacer	1
14	130014	Lock Nut M16	3
15	130015	Bolt M12x40	8
16	130016	Bearing HCFS207-23 C/W Cast Flange	2
17	130017	Washer 12	8
18	130018	Lock Washer 6	1
19	130019	Connector Link #60	1
20	130020	Roller Chain #60 (56-1/2")	1
21	130021	Bolt M10x30	6
22	130022	Auger Drive Sprocket	1
23-50"	135023	Auger for 50"	1
23-60"	136023	Auger for 60"	1
23-72"	137223	Auger for 72"	1
23-76"	137623	Auger for 76"	1
24	130024	Fan	1
25	130025	Flat Washer 3/8"	1
26	130026	Bolt 3/8"x1-1/4"	1
27	130027	Lock Pin 6x40	1
28	130028	Turning Screw	1
29	130029	Bolt M6x40	1
30	130030	Lock Nut M6	1
31	130031	Hand Crank	1
32	130032	Mounting Plate for Handle	1

REF NO.	PART NO.	DESCRIPTION	QTY
33	130033	Nylon Washer	1
34	130034	Special Washer ø12x0.2	10
35	130035	Bearing 6301-2RS1	5
36	130036	Lock Nut M8	3
37	130037	Mounting Plate for Chute	1
38	130038	Lock Bolt	2
39	130039	Bolt M12x45	5
40	130040	Chute (W/O Deflector)	1
41	130041	Bolt M8x30	1
42	130042	Bolt M6x30	1
43	130043	Adjusting Arm	1
44	130044	Deflector Hinge Pin	1
45	130045	Cotter Pin ø2	2
46	130046	Deflector	1
47	130047	Lock Plate	1
48	130048	Mounting Bracket for Crank Handle	1
49-50"	135049	Cross Shaft for 50"	1
49-60"	136049	Cross Shaft for 60"	1
49-72"	137249	Cross Shaft for 72"	1
49-76"	137649	Cross Shaft for 76"	1
50	130050	PTO	1
51	130051	Bolt M18x130	1
52	130052	Lock Nut M18	4
53	130053	Bolt M10x130	4
54	130054	Hitch Pin ø22x120	2
55	130055	Lock Pin ø8	2
56	130056	Keystock 1/4 Sq. x 1-1/2	1
57	130057	Gearbox	1
58	130058	A-Frame	2
59	130059	Left Tube Hitch Frame	1
60	130060	Right Tube Hitch Frame	1
61	130061	Connecting Bracket	1
62	130062	Rear Brace	1
63	130063	Bolt M18x45	2

Plastic Shield Assembly #69.888.998

**Tractor Yoke
21-10-00**



**Shearbolt Clutch
Series 4
57-117-18**

Complete PTO - Bondioli Type Series 4 # 69.888.400

**Nut # 09-000.008
Nyloc M8x1.25**

**Shearbolt # 01.008.045
M8 x 45x1.25 (GR8.8)**



BE-SBSxxxG

AVOIDABLE DAMAGES

POSSIBLE CAUSES

CORRECTIVE ACTIONS

SHIELD

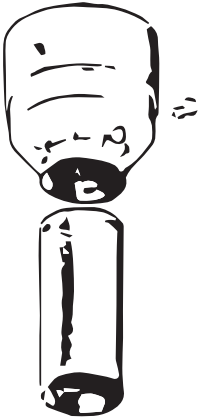
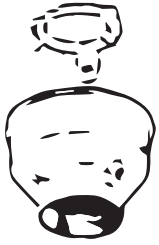

- Excessive wear of shield bearings.

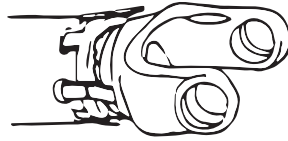

- Chain moving or failure.

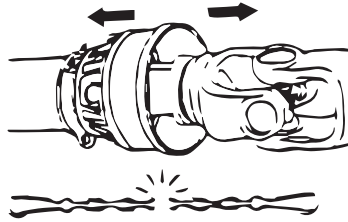

- Guard cone damaged.

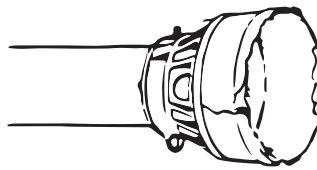

- Guard tubes damaged (deformed and split at one side).

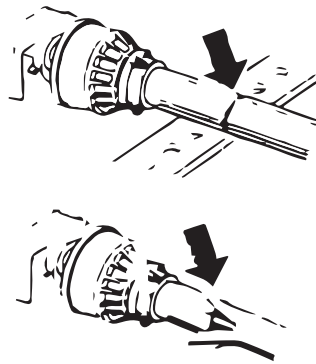

- Insufficient lubrication

- Incorrect chain mounting.

- Shield interfering with implement.

- Shield interfering with implement

- Incorrect chain mounting.

- Guard cone in contact with components on the tractor and/or implement.

- Excessive Angularity.

- Guards in contact with components on the tractor and/or implement.

- Guard tubes overlap too short or no overlap at all with extended P.T.O. Drive shaft.

- Follow lubrication instructions
- Mount chain to allow maximum angularity.
- Avoid contact of the shields with fixed parts of the machine or tractor.
- Replace shield bearings.

- Avoid contact of the shields with fixed parts of the machine or tractor.
- Mount chain to allow maximum angularity.
- Replace defective parts.

- Eliminate interference between guard cones and any part on the tractor and/or implement.
- Avoid excessive angle during cornering or when lifting or lowering the implement.
- Replace damaged guard cones.

- Eliminate interference between guard cones and any part on the tractor and/or implement.
- Replace damaged tubes.
- Adjust guard tubes length with longer tubes.

*Note: Shield bearing must be greased every 8 working hours.

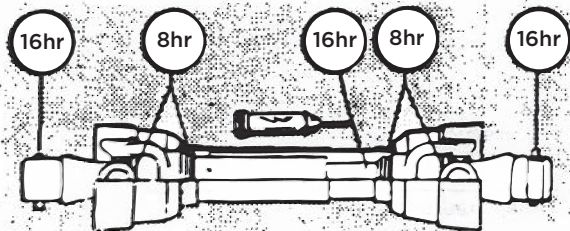

For any additional details (capacity, angle, length), please refer to catalogue.

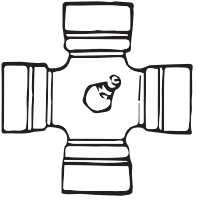
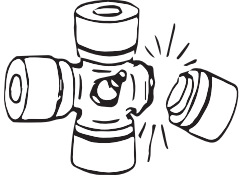
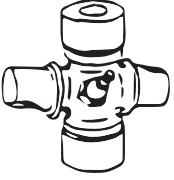

Sold by:

BE-SBSxxxxG	AVOIDABLE DAMAGES	POSSIBLE CAUSES	CORRECTIVE ACTIONS
Cross Kit 	<ul style="list-style-type: none"> - Cross arms broken. 	<ul style="list-style-type: none"> - Extreme torque peak or chock load. - Axial Loads too high. 	<ul style="list-style-type: none"> - Use appropriate safety device. - Change to a larger P.T.O. size. - Shorten P.T.O. shaft - Replace defective cross bearings.
	<ul style="list-style-type: none"> - Bearing caps turning in their cross journal. - Overheated bearing caps. 	<ul style="list-style-type: none"> - Excessive continuous torque and/or excessive working angle. - Inadequate greasing. 	<ul style="list-style-type: none"> - Verify compatibility between shaft and working conditions. - Carefully allow greasing instructions. - Replace affective cross bearings.
	<ul style="list-style-type: none"> - Accelerated wear of cross kit. 	<ul style="list-style-type: none"> - Excessive continuous torque and/or excessive working angle. - Inadequate greasing. 	<ul style="list-style-type: none"> - Verify compatibility between shaft and working conditions. - Carefully follow greasing instructions. - Replace defective cross bearing.

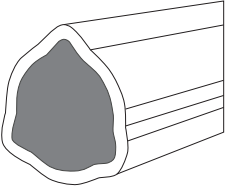

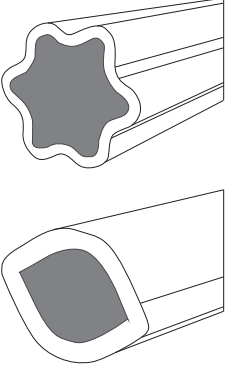
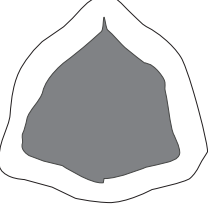
*Note: Cross bearing must be greased every 8 working hours.

	AVOIDABLE DAMAGES	POSSIBLE CAUSES	CORRECTIVE ACTIONS
Telescopic Tube 	<ul style="list-style-type: none"> - Telescopic tubes failure or twisting. 	<ul style="list-style-type: none"> - Extreme torque peak or shock load. - Short tube engagement. 	<ul style="list-style-type: none"> - Use appropriate safety device. - Change to larger P.T.O. size - Replace the P.T.O. drive shaft with one having adequate length. - Replace defective tubes.
	<ul style="list-style-type: none"> - Accelerated wear of telescopic tubes. 	<ul style="list-style-type: none"> - Extreme load when sliding. - Short tube engagement. - Inadequate greasing. - Continuous (sand, etc.). 	<ul style="list-style-type: none"> - Change to a P.T.O. drive shaft with one having adequate length - Replace the P.T.O. drive shaft with one having adequate length. - Carefully follow greasing instructions. - Replace defective tubes.

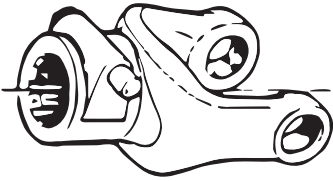
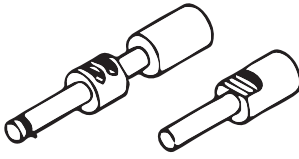
*Note: Telescopic tubes must be cleaned and greased every 16 working hours.

BE-SBSxxxxG	AVOIDABLE DAMAGES	POSSIBLE CAUSES	CORRECTIVE ACTIONS
<p>Quick-disconnect yoke</p> 	<ul style="list-style-type: none"> - Quick-disconnect pin tight or completely seized. - Quick-disconnect pin damaged (broken or bent). - Quick-disconnect pin damaged in the locking portion. 	<ul style="list-style-type: none"> - Quick-disconnect pin dirty (insufficient maintenance). - Quick-disconnect pin defective (forced engagement, incorrect handling). - Excessive shaft length. - Axial loads too high. 	<ul style="list-style-type: none"> - Clean, oil and follow service instructions. - Replace quick-disconnect pin. - Shorten shaft length (cut both telescopic tubes as well as shields and remove burrs). - Replace quick-disconnect pin. - Clean and grease telescopic tubes and replace both tubes, if necessary. - Replace quick-disconnect pin.

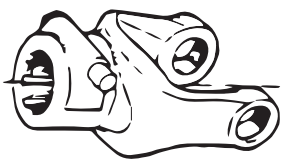
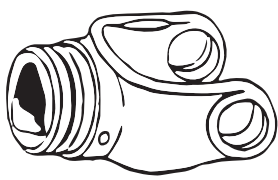
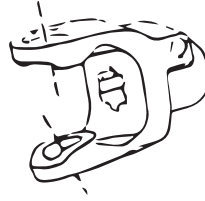
*Note: Quick-disconnect pins must be cleaned and greased every 16 working hours.

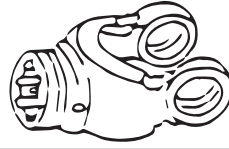
	AVOIDABLE DAMAGES	POSSIBLE CAUSES	CORRECTIVE ACTIONS
<p>Yoke</p>   	<ul style="list-style-type: none"> - Yoke ears deformation.  	<ul style="list-style-type: none"> - Excessive shaft length. - Axial loads too high. - Excessive working angle and torque. 	<ul style="list-style-type: none"> - Shorten shaft length (cut both telescopic tubes as well as shields and remove burrs). - Replace defective yokes. - Clean and grease telescopic tubes and replace both tubes if necessary. - Replace defective yokes. - Verify compatibility between shaft and working conditions - Disengage tractor P.T.O. during cornering or when lifting or lowering the implement. - Replace defective yokes.
	<ul style="list-style-type: none"> - Yoke ears distorted. 	<ul style="list-style-type: none"> - Overload caused by high starting and peak torques. 	<ul style="list-style-type: none"> - Engage P.T.O. more carefully. - Use appropriate safety device. - Replace defective yokes.
	<ul style="list-style-type: none"> - Yoke ears worn or pounded. 	<ul style="list-style-type: none"> - Excessive working angle. 	<ul style="list-style-type: none"> - Avoid excessive working angle. - Disengage tractor P.T.O. during cornering. - Replace defective yokes.

