

LONGITUDINAL PROFILE

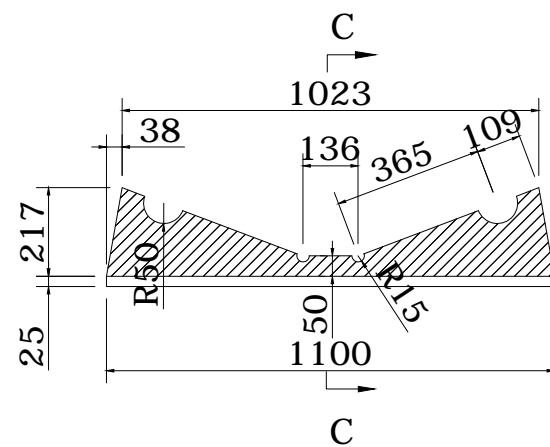

TRANSVERSAL SECTION "A"

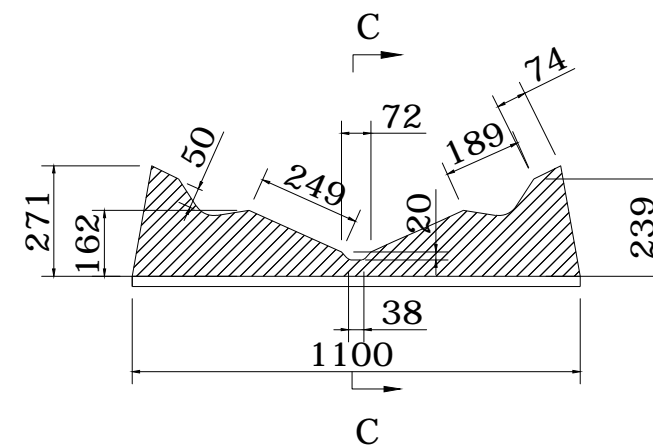

TRANSVERSAL SECTION "B"

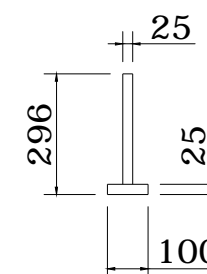

TRANSVERSAL SECTION "C"

	PA 460 CHOCK		DWN: SJW
			APPROVED: LXL
info@highfieldboats.com	DWG:	SCALE:	DATE: 2020.08.27

(C) Copyright reserved. No unauthorized use allowed.  
All intellect - ideas - concepts remain the property of Highfield Boats