

TRANSVERSAL SECTION "A"

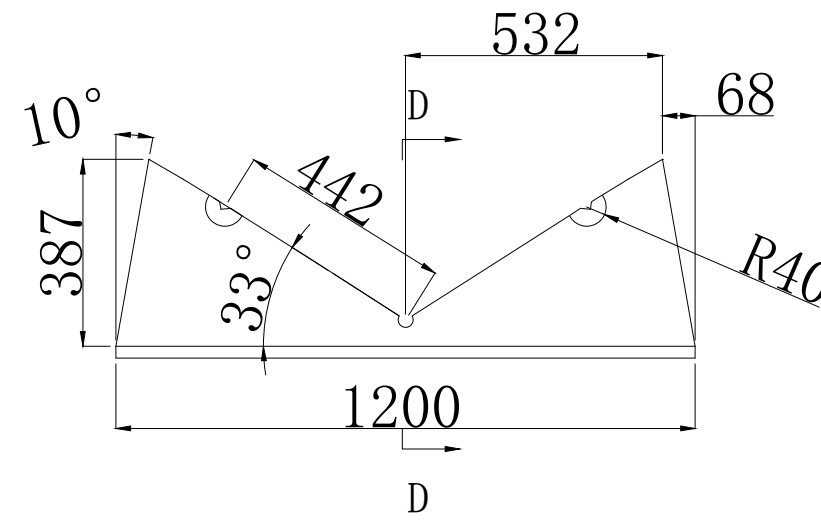

TRANSVERSAL SECTION "B"

	PA 500		DWN: SYJ
			APPROVED: LXL
info@highfieldboats.com	DWG:	SCALE:	DATE: 2019.01.23

(C) Copyright reserved. No unauthorized use allowed.  
All intellect - ideas - concepts remain the property of Highfield Boats