

EMMO

GREEN YOUR LIFE

USER'S MANUAL



EMMO
Kamen

CAUTIONS

This manual contains important safety, performance and service information. Read and understand it along with the information provided during the on-delivery instructions before using the product, and keep it for reference.

EMMO

© 2020 Emmo Inc. All rights reserved. No texts, details, or illustrations from this manual may be reproduced or distributed, or become the subject of unauthorized use for commercial purposes. Should you discover any errors, we would be grateful if you would bring them to our attention.

MENU

About EMMO	4
Rules and Regulations of Riding an E-Bike	5
Parts Overview	6
Switches	8
Throttle	10
<i>Lights & Signals</i>	11
<i>Speedometer</i>	13
Audio System	14
Side Kickstand	15
Rear View Mirrors	16
How to turn on the bike with the key	18
How to turn on the bike with the remote	19
How to lock the steering	20
How to turn on/off the circuit breaker	22
How to charge	25
How to ride	27
Safety Instructions	28
Maintenance	29
E-Bike Registration Form	30
Appendix 1(How to charge a lithium battery)	31
Appendix 2(Charger indicators)	34

ABOUT EMMO

Established in 2009, Emmo Inc. is a proud Canadian venture that is focused on creating a more sustainable future by providing high quality electric bicycles. We offer a wide variety of e-bikes that are suitable for leading a greener, and more stylish, way of living. Emmo e-bikes are priced competitively with other green solutions. At Emmo, you will get the best e-bikes and the most professional service.



GREEN YOUR LIFE

RULES and REGULATIONS

of riding an e-bike

According to Canada's Motor Vehicle Safety Regulations (**MVSR**). A qualified e-bike (defined as Power Assist Bicycle) must meet the following requirements:

- ***The e-bike must have operable pedals***
- ***Upper wattage limit for the motor is 500W.***

Other requirements include a permanently affixed compliance label from the manufacturer stating that the vehicle is a power-assisted bicycle under statutory requirements in force at the time of manufacture. Currently, there is no license, no insurance, and no vehicle registration required to operate a qualified e-bike according to federal legislation. E-Bike riders share the same rights and responsibilities as other road users.

However, provinces and local municipalities have the power to restrict the use of e-bikes. Most provinces require the rider to wear a helmet. Some provinces have special requirements with regard to the age limit to operate an e-bike, the type of helmet required, even the number of wheels and wheel size. In Ontario, typically, e-bikes are generally treated the same as regular bicycles. According to the Ministry of Transportation of Ontario (MTO), the age limit to operate an e-bike is 16 years old and above; the maximum weight of the bike is 120 kilograms (265 pounds); the bike must have a brake distance of less than 9 meters; Any modifications made to the bike's motor to create speeds greater than the legal speed limit are prohibited.

As the rules and regulations are subject to changes in different provinces and municipalities. Please check your municipal bylaw and see where you stand.

1. PARTS OVERVIEW

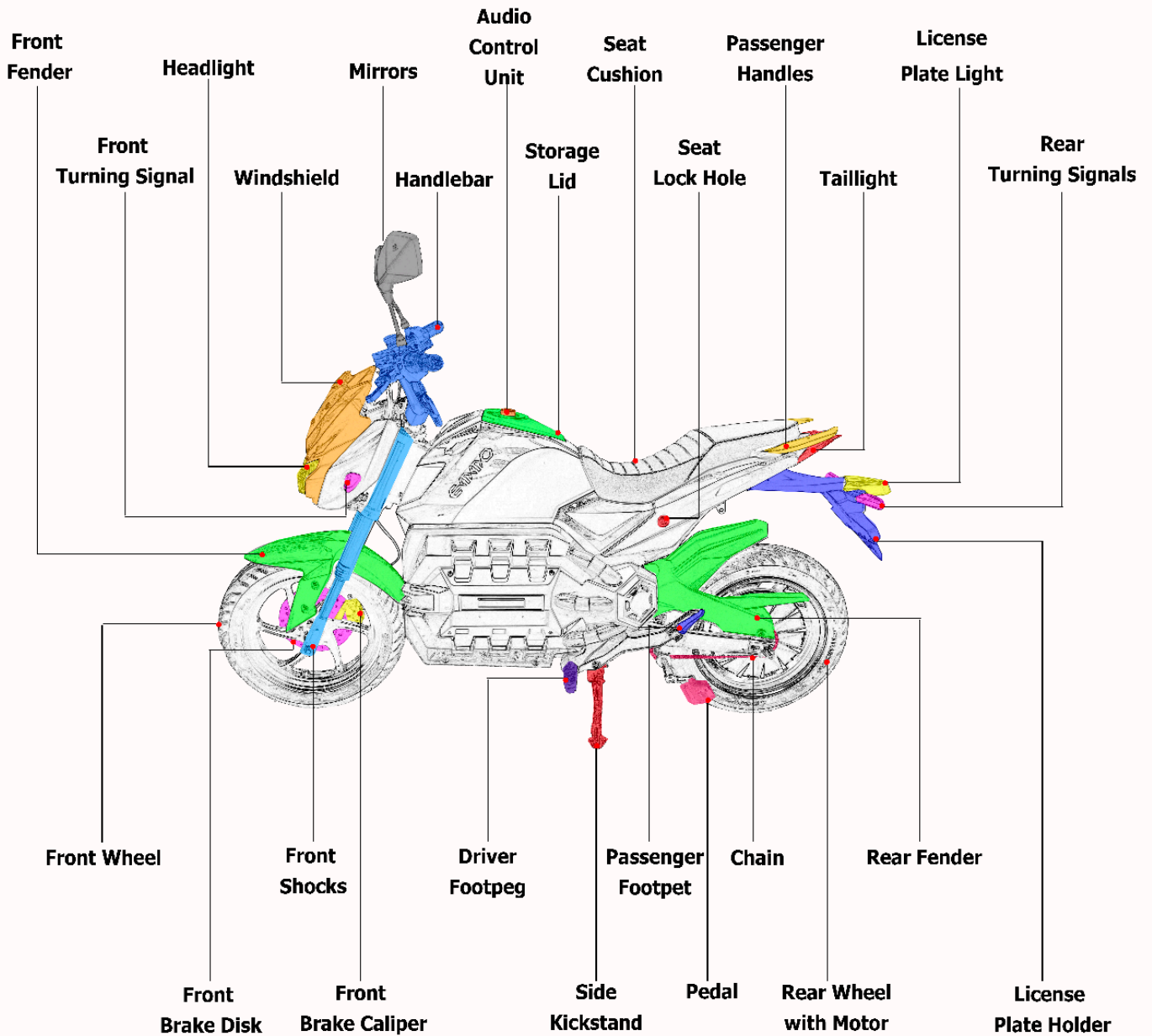

1. PARTS OVERVIEW

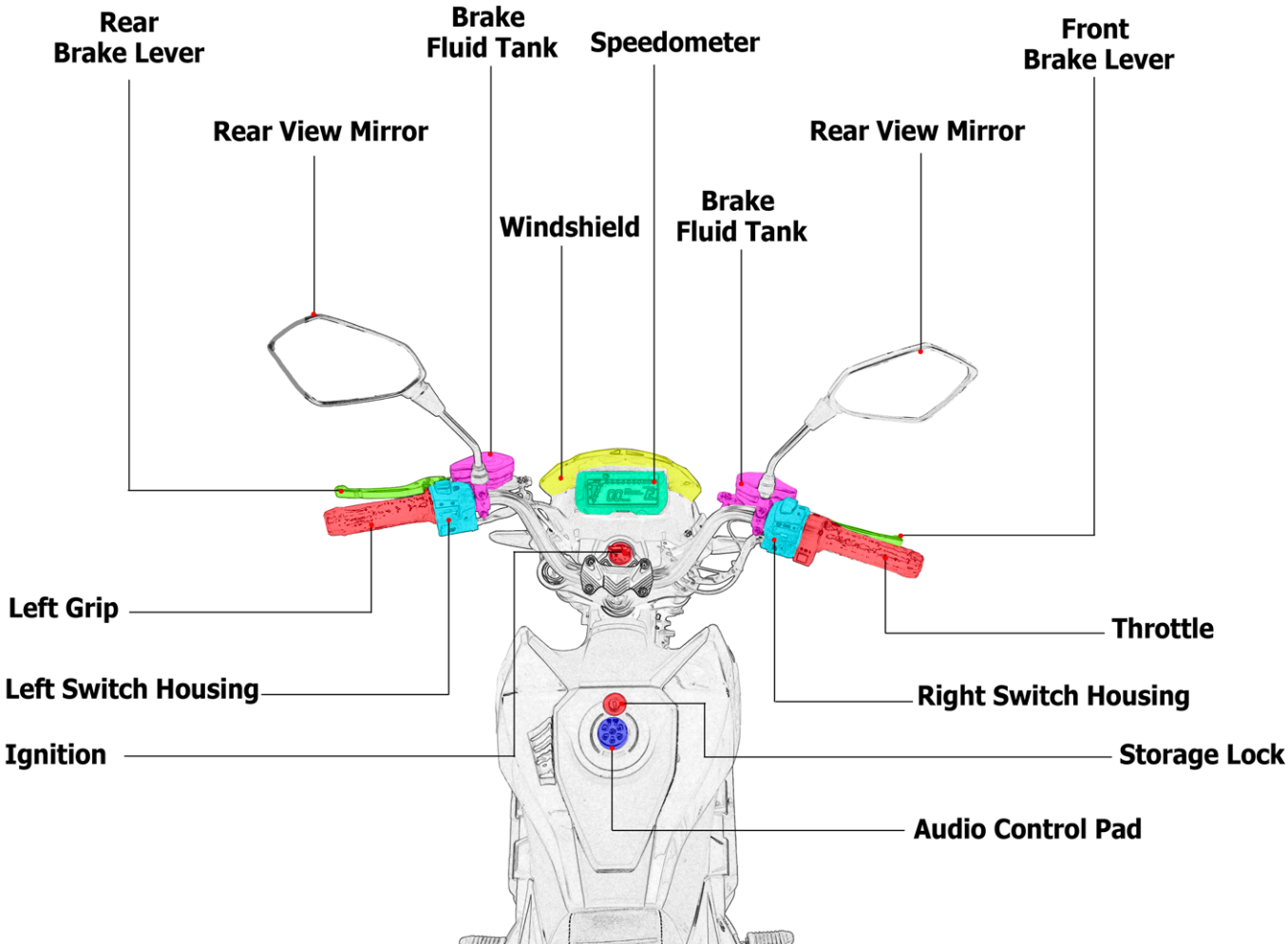

2. SWITCHES

The switch housings on the handlebar hold these switches that control the lights, signals, horn and etc..

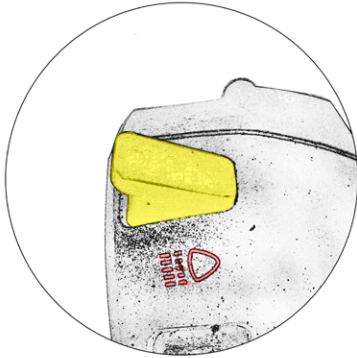

Headlight Flashing:

Press the button once to flash the high beam.

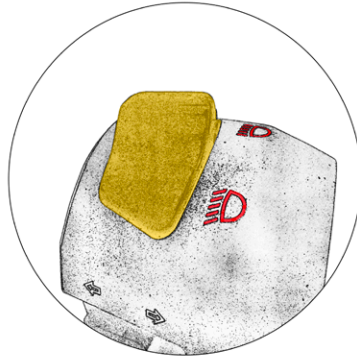

High/Low Beam Switch:

Press the button down will turn the corresponding beam on.

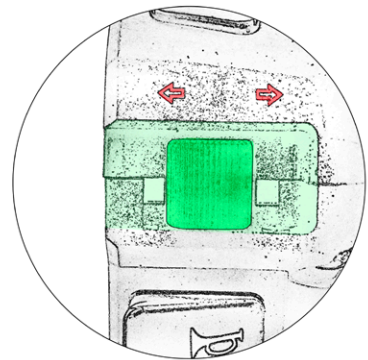

Turning Signal Switch:

Sliding the switch to the left/right will turn on the left/right side turning signals. Push the switch lever in to cancel the signals.

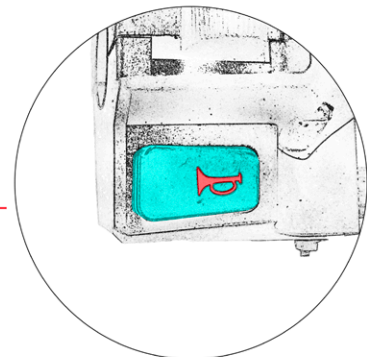
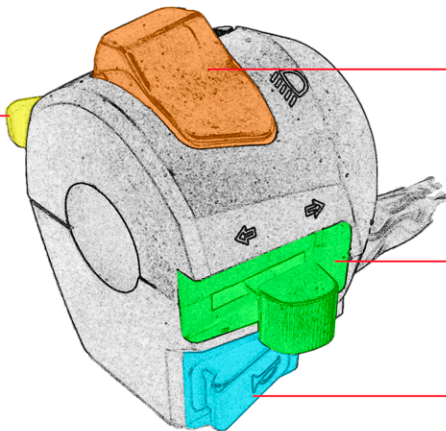

Horn Button:

Press the button to sound the horn.

2. SWITCHES

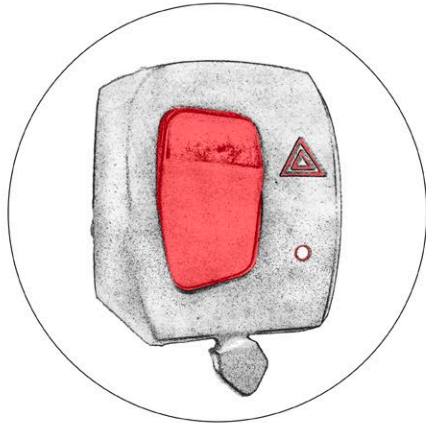

Emergency Harzard Lights:

Press the button to turn on all turning signal lights.

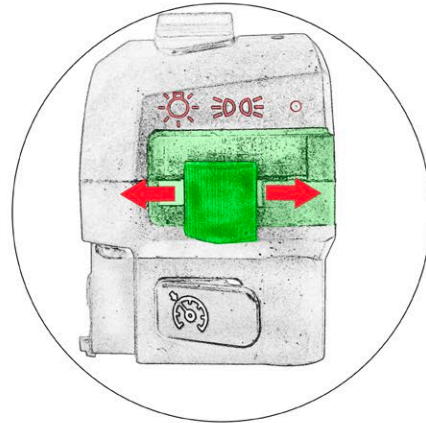

Headlight/Tail Light:

Slide the switch to turn on the headlight / tail light.

- :Off
- ☰☱☲☳ :Tail Light
- ☀☰☱☲☳ :Headlight + Tail Light

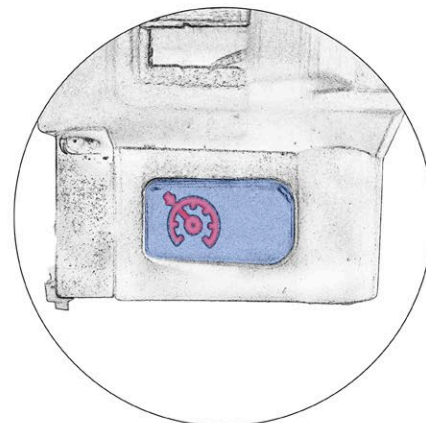
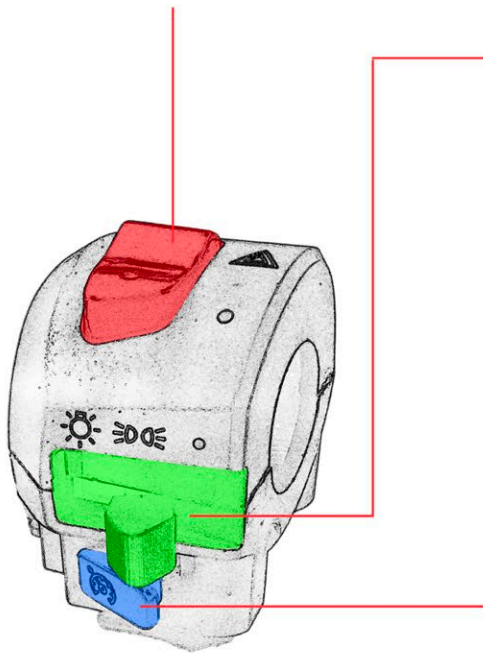

Cruise Control:

Press the button to activate the cruise control. To cancel the cruise function, press the button again or apply the brake.

3. THROTTLE

The throttle controls the speed of the e-bike. As shown below, twist the throttle towards you to operate. With the help of the speed mode switch, you can also change the speed setting.

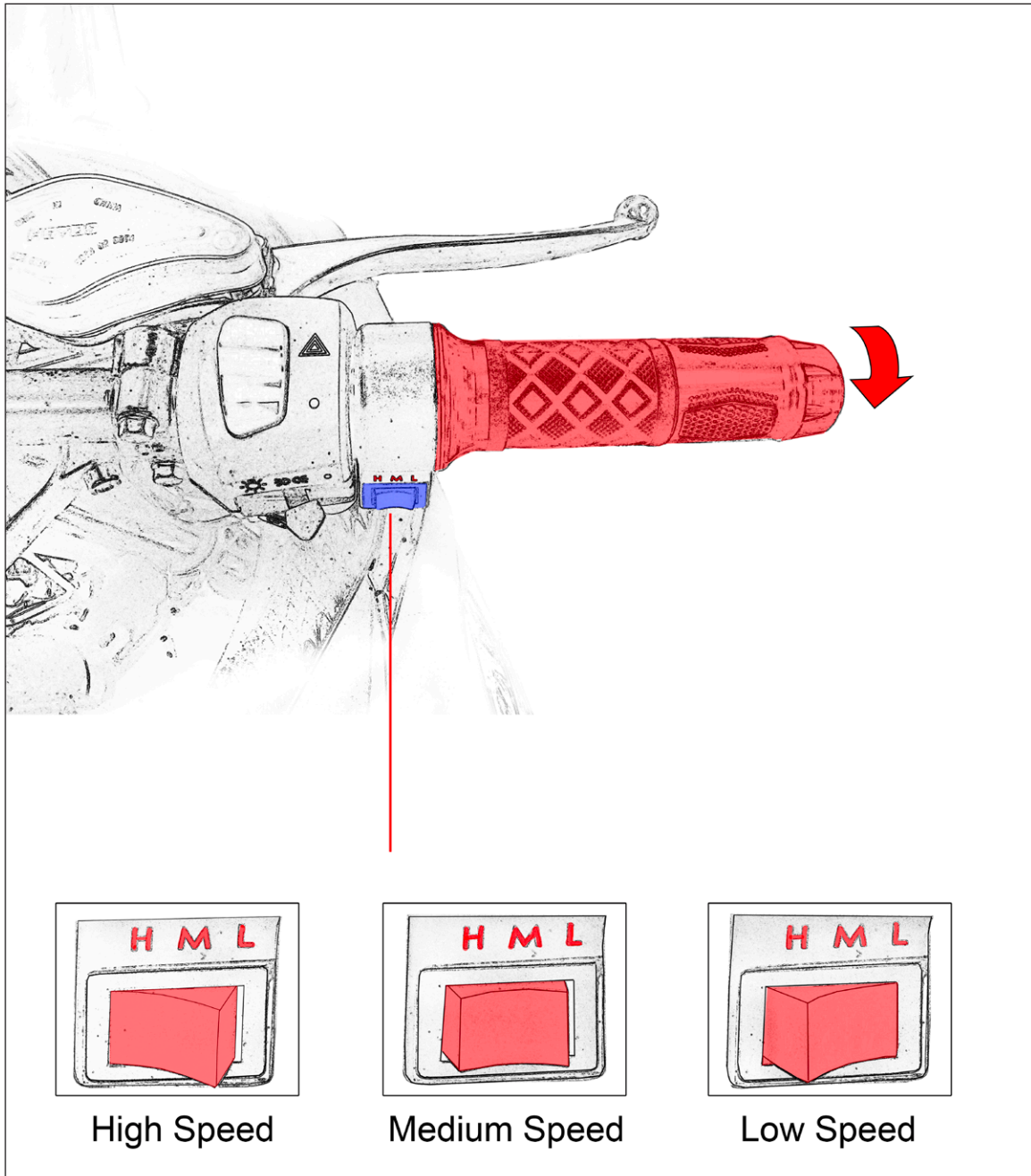

Warning:

- DO NOT turn the throttle if you are not ready to ride.

4. LIGHTS & SIGNALS

The headlight assembly has different operation modes - daytime running light, high beam, and low beam to accommodate your needs under different conditions.

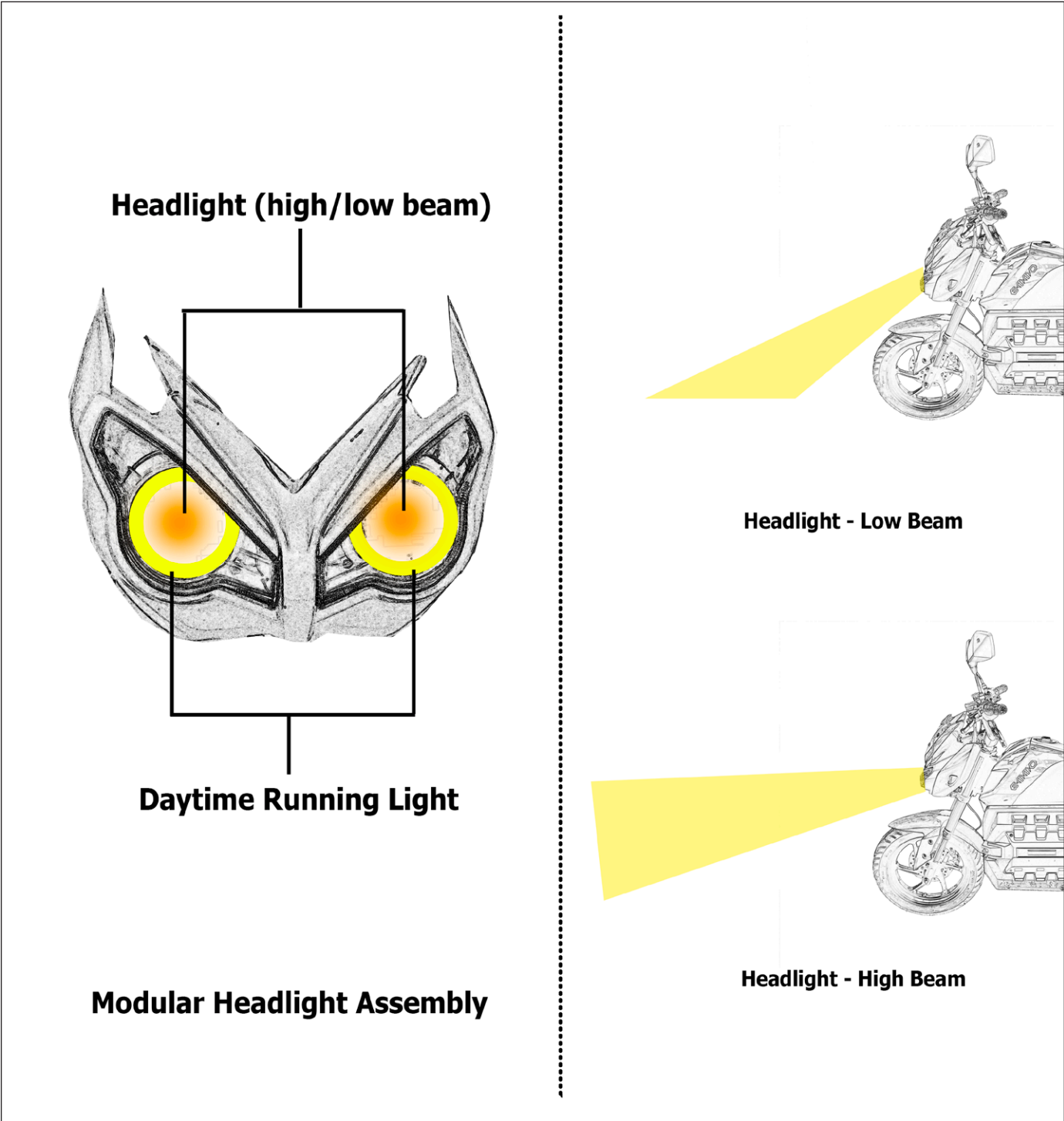

4. LIGHTS & SIGNALS

Tail light and brake light play an important role in signaling people behind. With the help of the turning signal lights, it is also easier for other road users to anticipate your intended route.

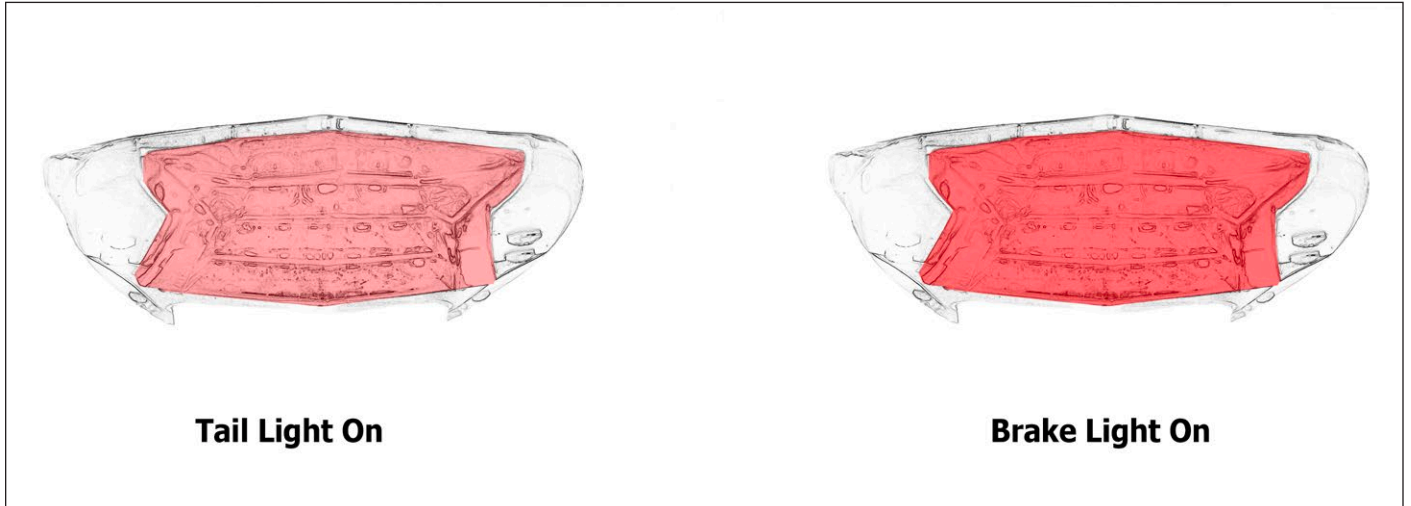

The tail lights become brighter when the brake is applied.

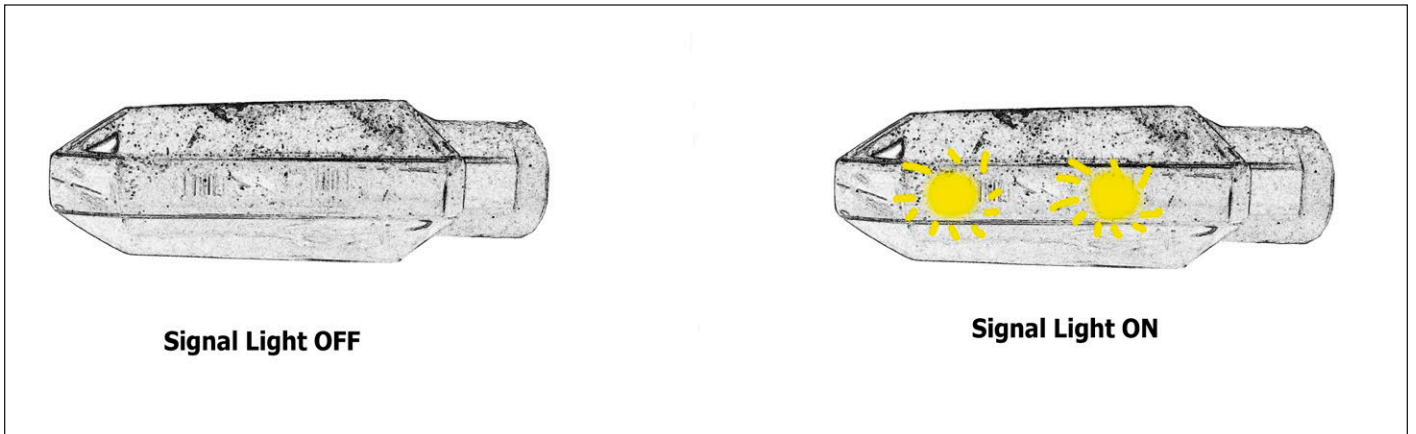

Turning signal light will flash when turned on.

* For different versions, the turning signal lights may be different in design and function.

5. SPEEDOMETER

The speedometer let you know the working status of the bike. It provides information including the current speed, total travel distance, battery strength, and speed mode (3=high speed mode, 2=medium speed mode, 1=low speed mode).

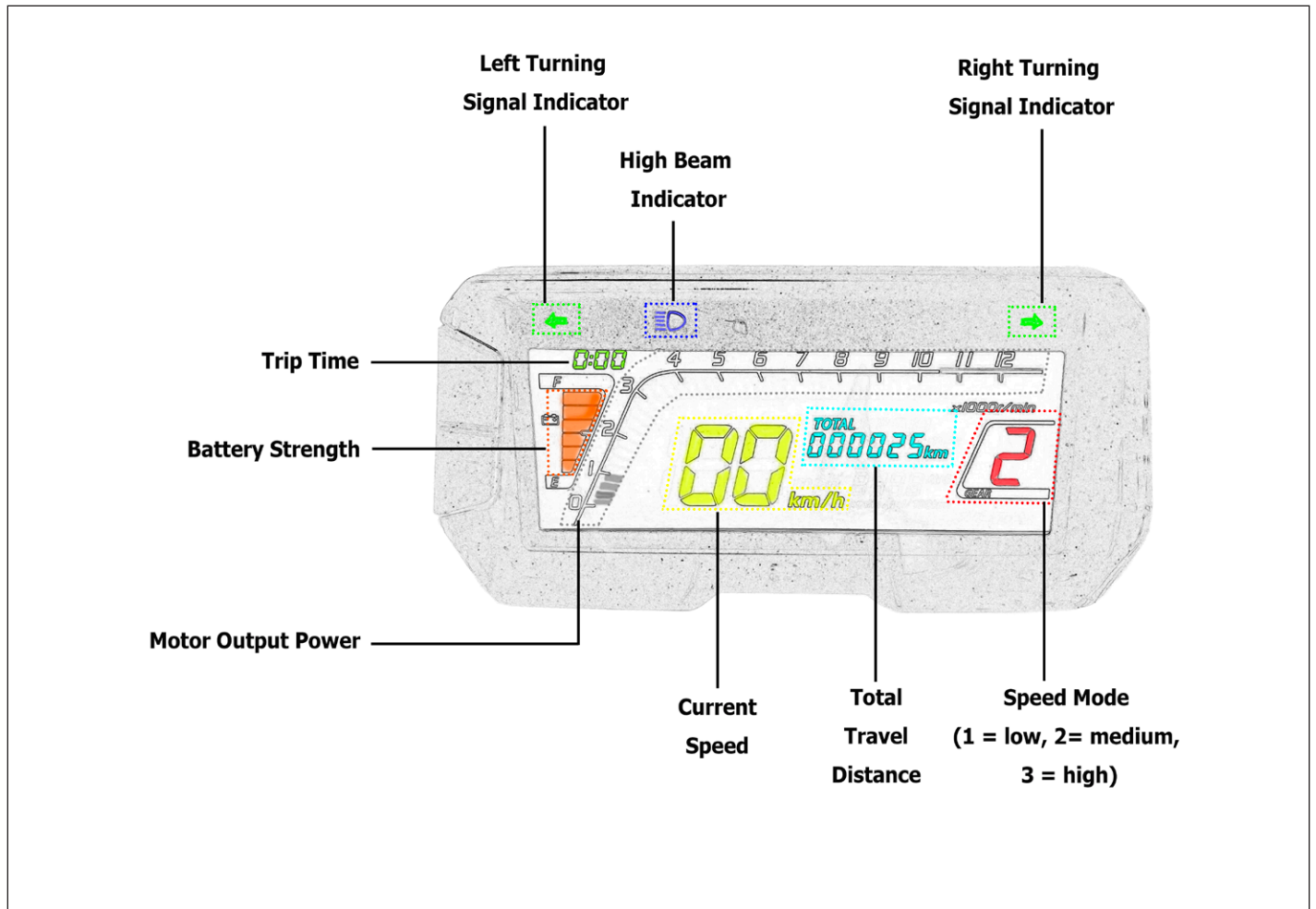

LCD Speedometer

6. AUDIO SYSTEM

The built-in audio system has two modes - MP3 player and FM radio.

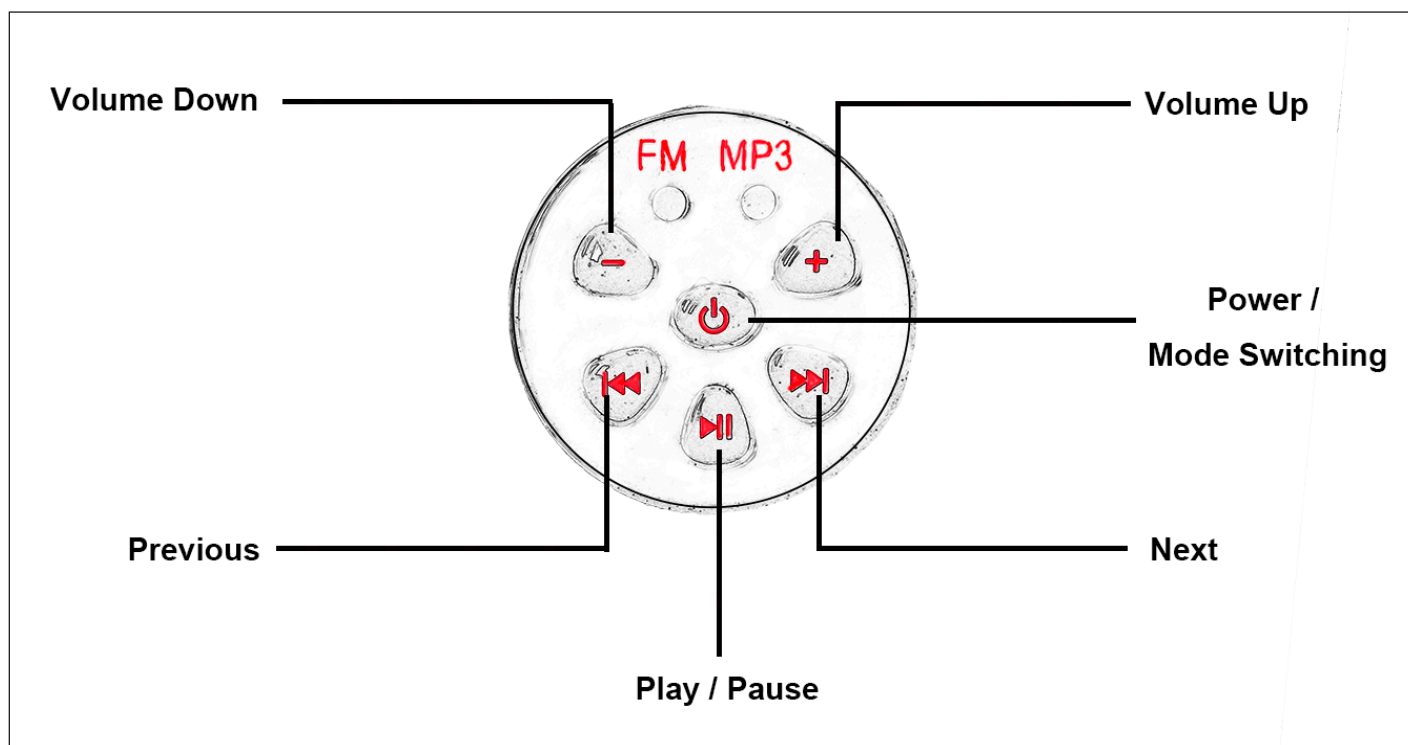

Press once to turn on the radio system. The MP3 mode is set by default. You can pair your bluetooth device with the built-in MP3 player (named Electric bike) and play the music. Press the button again to switch to FM radio mode. Press the button again to turn it off.



In MP3 mode, press the button once to pause. Press again to continue to play. In FM radio mode, hold the button for 5 seconds to search for available channels. Once finished, the system will stop at the first channel.



Turn the volume up.



Turn the volume down.



In MP3 mode, press the button once to play the previous song in the list. In FM radio mode, press the button once to switch to previous channel in the list.



In MP3 mode, press the button once to play the next song in the list. In FM radio mode, press the button once to switch to next channel in the list.

7. SIDE KICKSTAND

A kill switch is integrated into the side kickstand. As a safety feature, when the side stand is kicked down, the motor power will be cut off.

- **Side Kickstand Kill Switch**

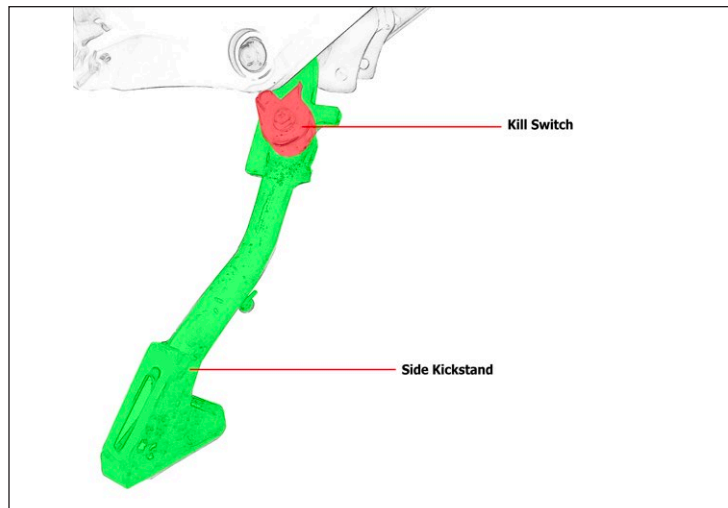

- **Put the bike on the side kickstand**

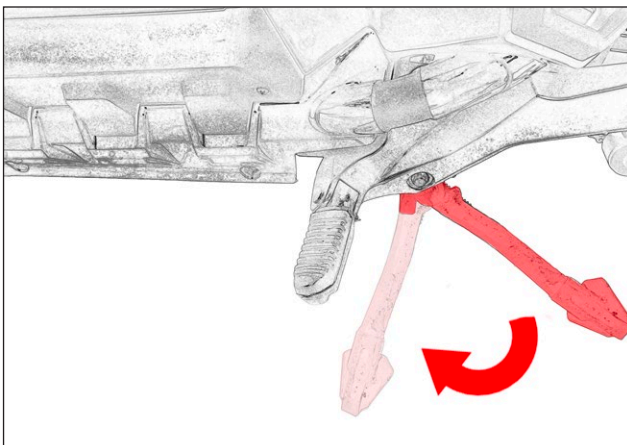

- Kick the side stand down and gently lean the bike on the side kickstand.

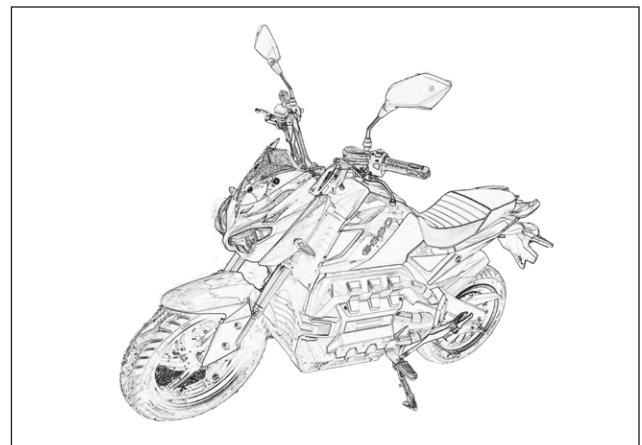

- Make sure it is stable before you leave your bike.

Warning:

- The side kickstand should be kicked up before you ride the bike.

8. REAR VIEW MIRRORS

Rear view mirrors make it safer for you to check the traffic condition behind you. Please make sure the rear view mirrors are adjusted and secured properly. Check the rear view mirrors and your blind spots before you make a turn or overtake other vehicles.

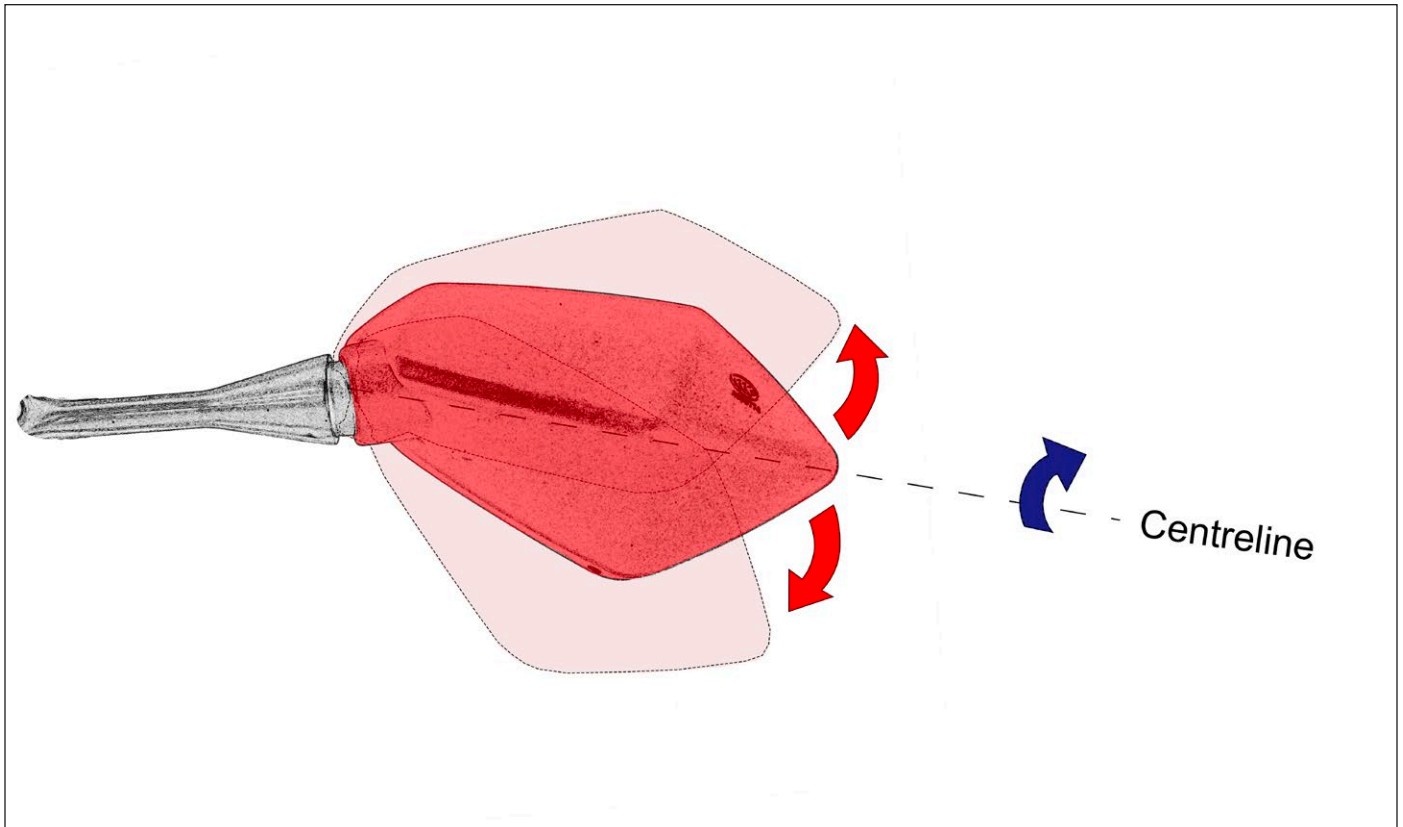

- The mirror can be tilted up and down for approximately 15 degree from the centreline (as showed by the red arrows).
- The mirror can also be rotated on the holding pole (as shown by the blue arrow).

8. REAR VIEW MIRRORS

-Adjustment

- *Tool needed: a 14mm wrench.*

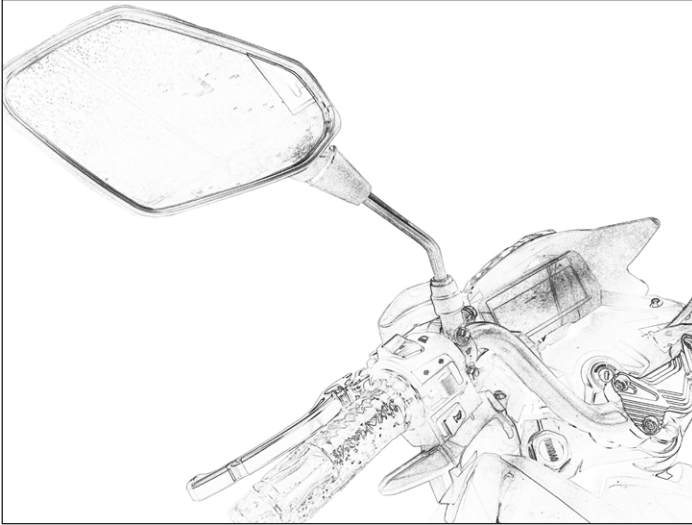

- In order to adjust the mirror, the nut that fixed the mirror should be loosened first.

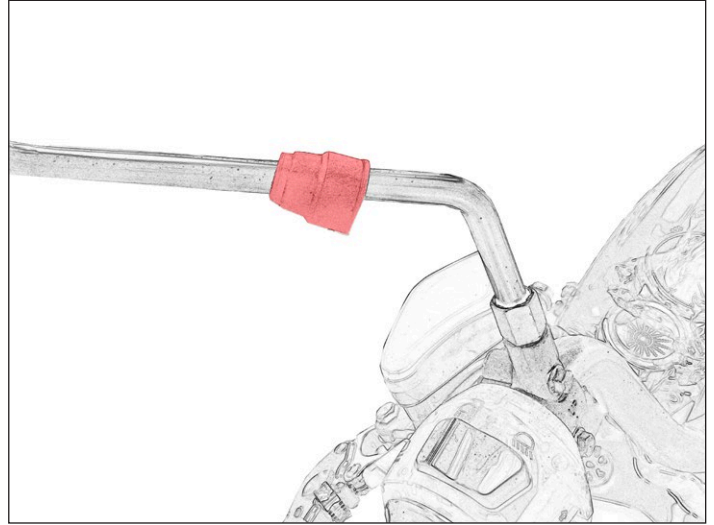

- The nut is covered by the plastic cap. Lift up the cap to expose the nut.

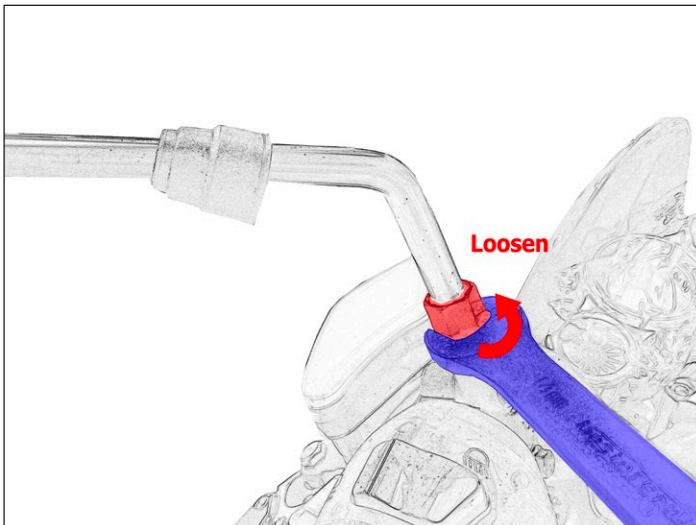

- Use the wrench and follow the direction indicated to loosen the nut slightly.

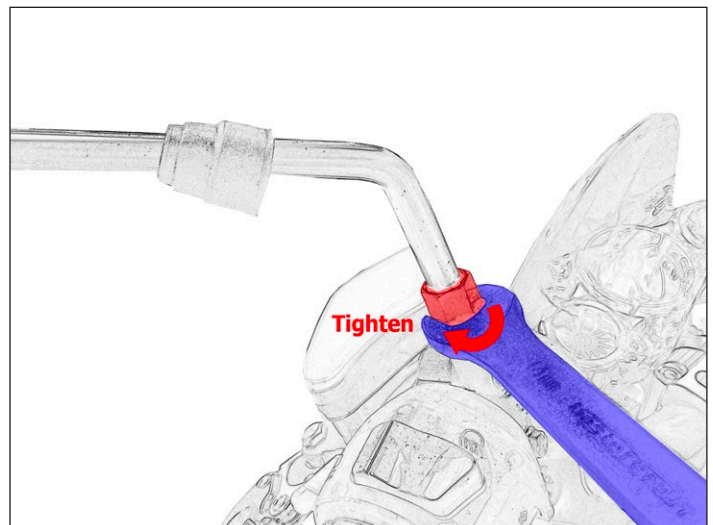

- Adjust the mirror to a preferred position and tighten the nut as shown.

Warning:

- DO NOT adjust the mirrors while you are riding the bike.
- Be careful when you tightened the nut to avoid damage to the threads and the mirror holders.

9. HOW TO TURN ON THE BIKE

via key ignition

With the key, you can turn on/off the bike and lock the steering (refer to Page 20).

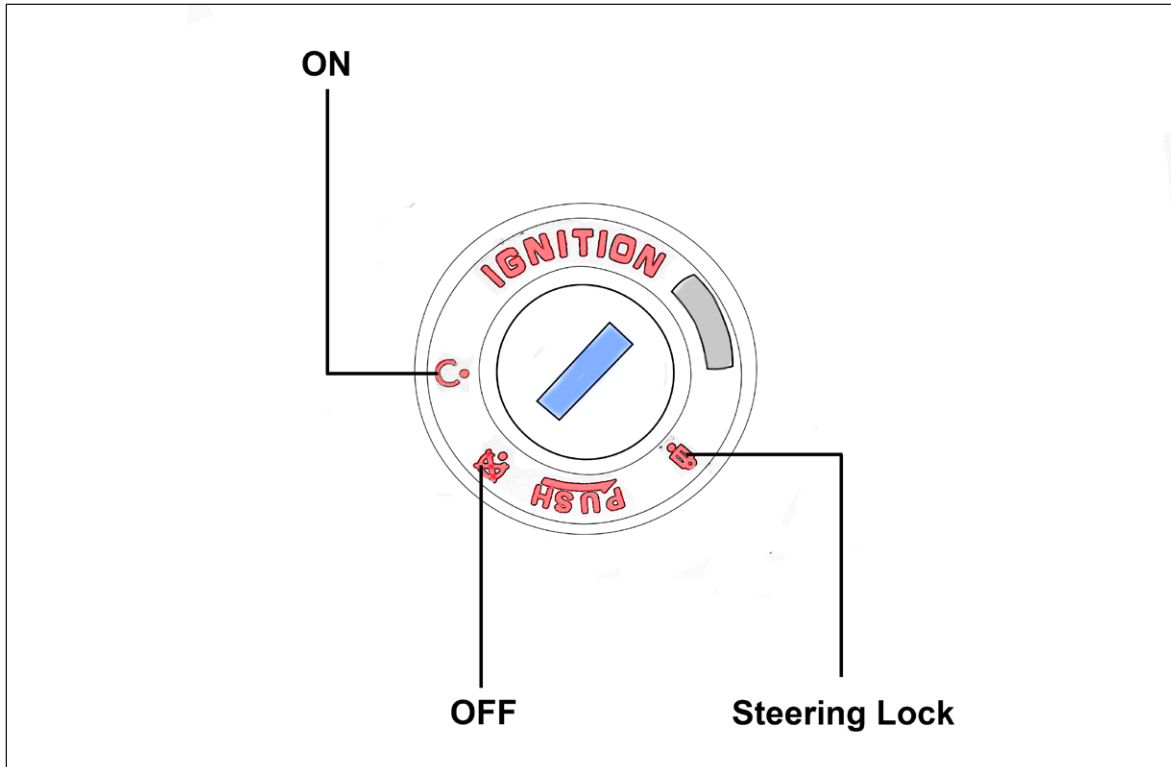

- The ignition is located in the triple tree plate, centre of the handlebar.

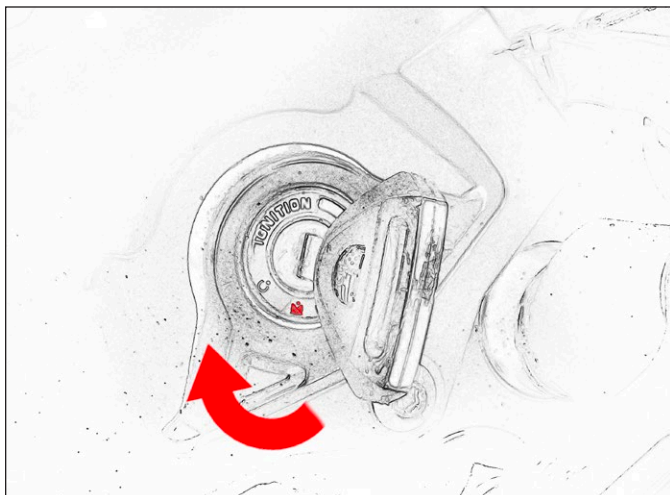

- To turn on the bike, plug the key into the main ignition key hole.



- Follow the marking on the ignition, turn the key to the right to turn on the bike.

9. HOW TO TURN ON THE BIKE

via remote

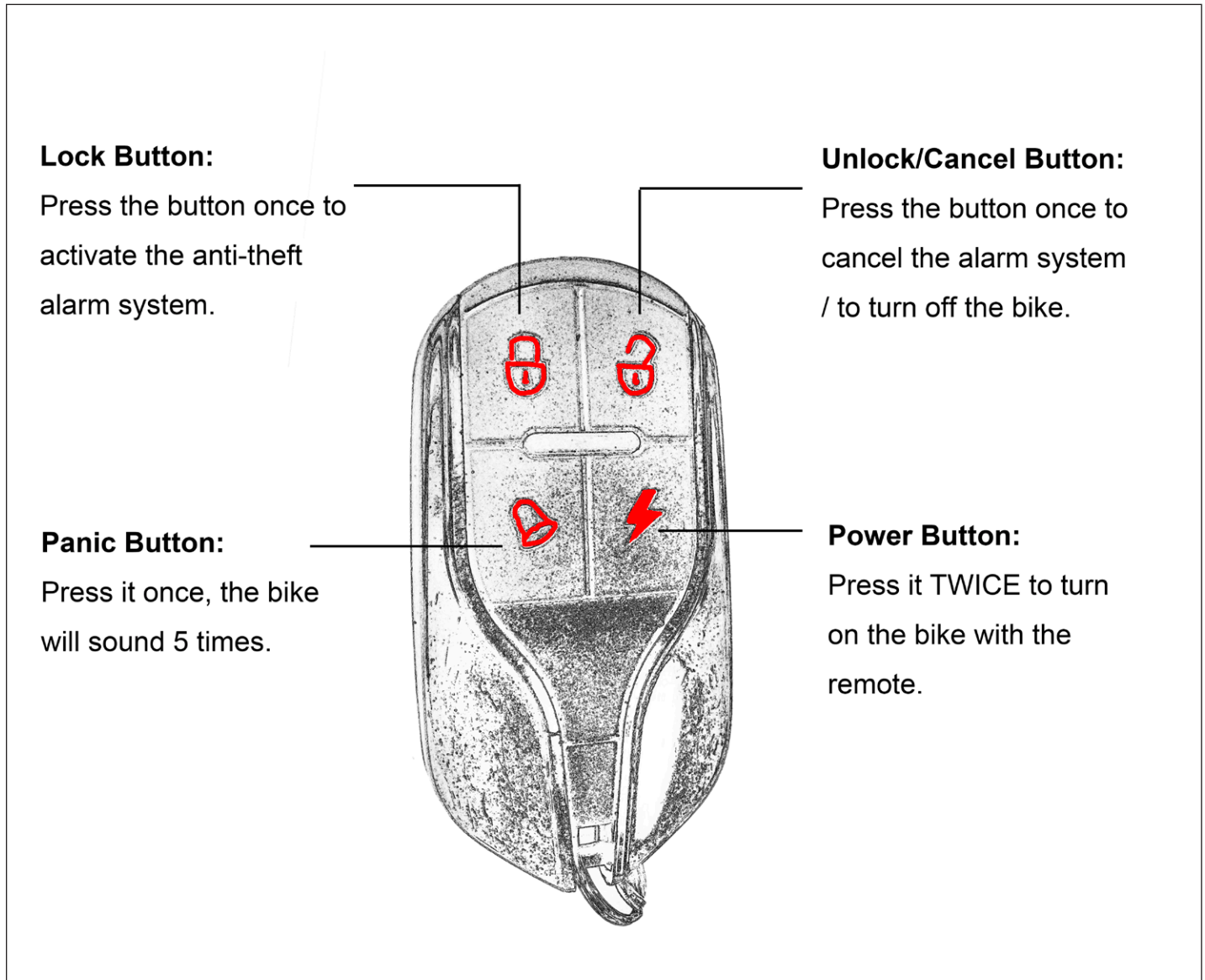

Reminder:

- If the alarm system is on, please cancel the alarm before you turn on the bike.

10. HOW TO LOCK THE STEERING

For the safety of your bike, it is highly recommended to lock the steering when you park your bike in public spaces.

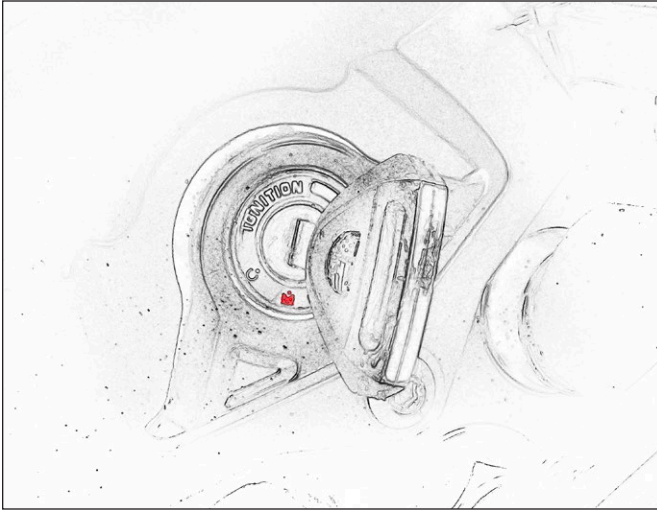

- Turn the ignition off.

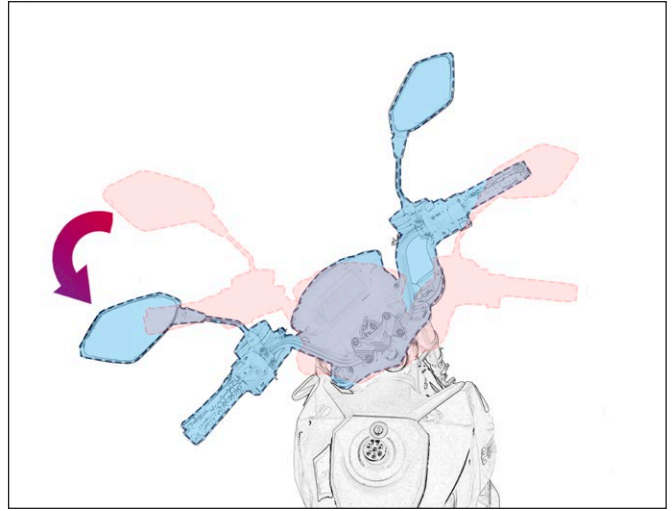

- To lock the steering, turn the handlebar to the left.

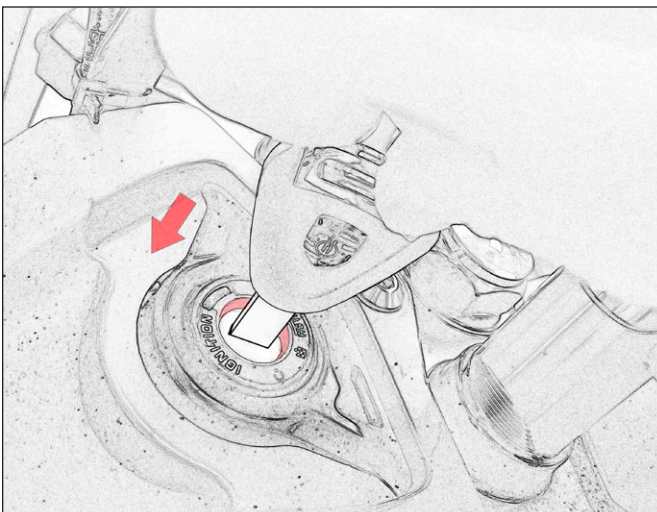

- Push the key in.

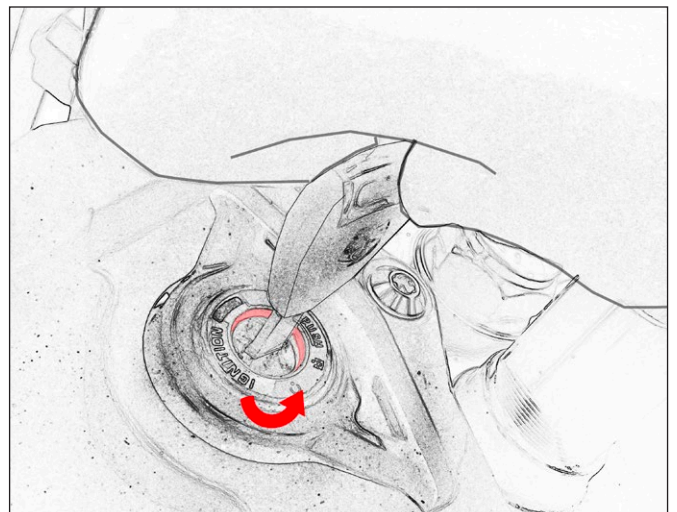

- Follow the mark on the ignition, turn the key anti-clockwise to lock the steering.

10. HOW TO LOCK THE STEERING

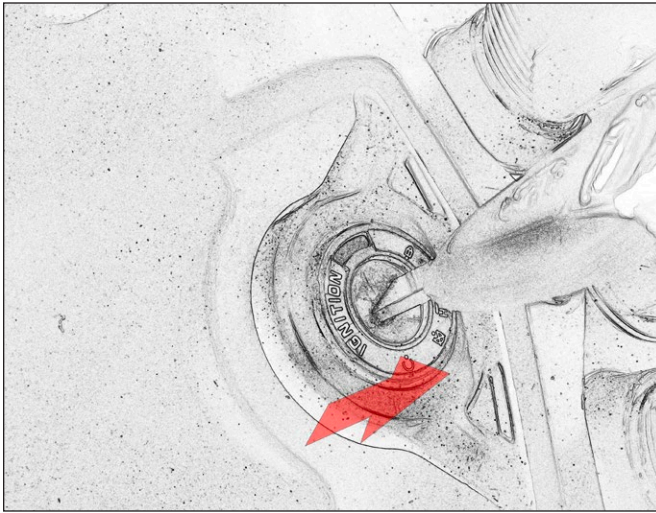

- Remove the key when the steering is locked.

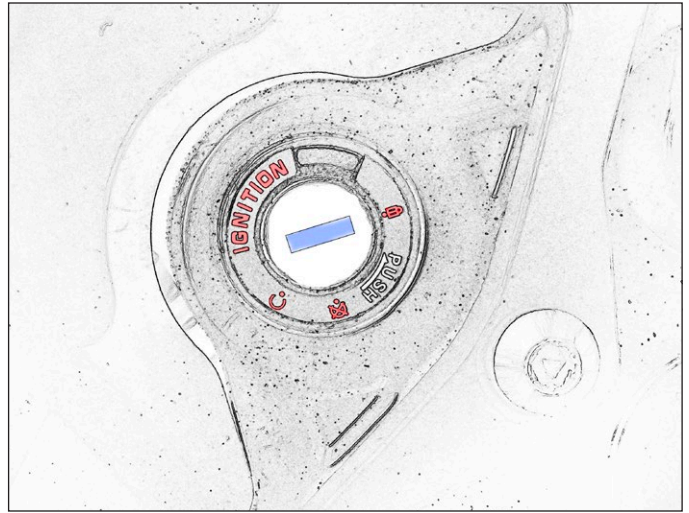

- The steering cannot be turned when locked.

11. CIRCUIT BREAKER

location & instructions

Located in the storage compartment under the seat, the circuit breaker is the main switch of the bike. When it is turned off, the battery will be disconnected from the system and you will not be able to use the bike, nor will you be able to charge the bike.

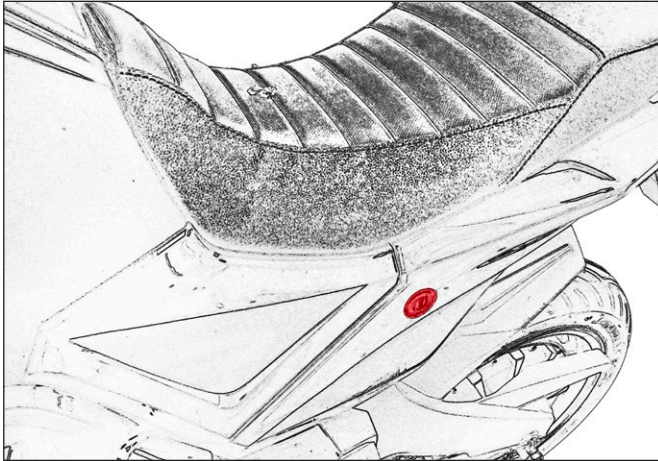

- The seat lock is located on the left side of the bike, below the seat cushion.

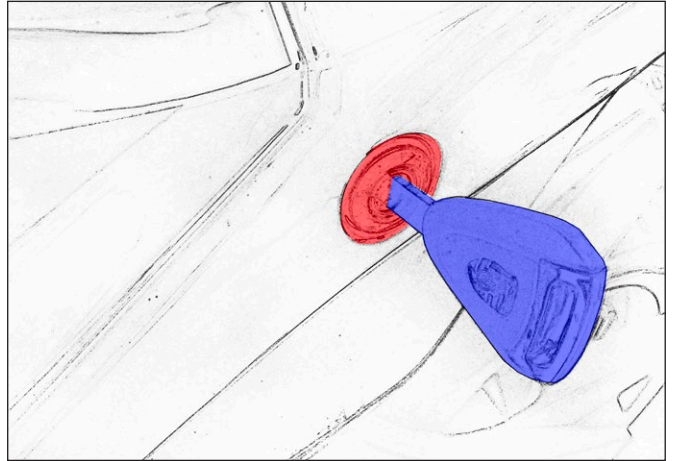

- Insert the key.

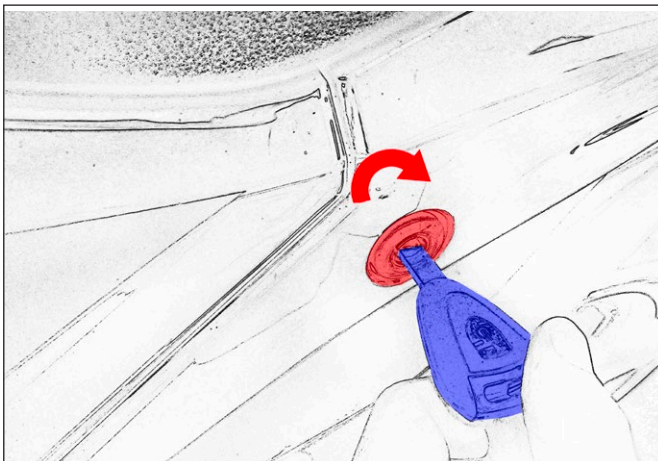

- Turn the key in the direction as indicated to unlock the seat.

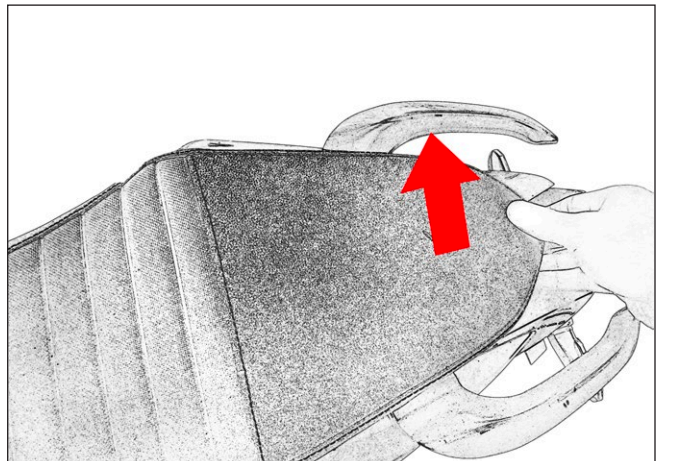

- While keeping the seat lock in the unlocked position, gently lift the seat up.

11. CIRCUIT BREAKER

location & instructions

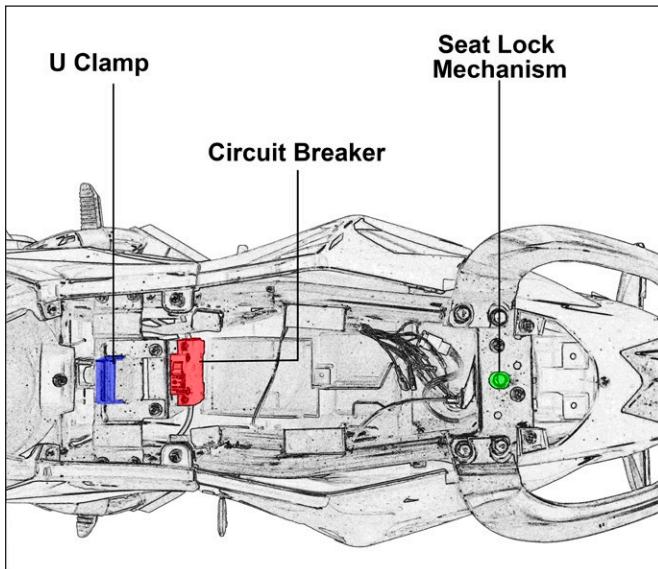

- The circuit breaker is located on the wall of the under-seat compartment (marked in red).

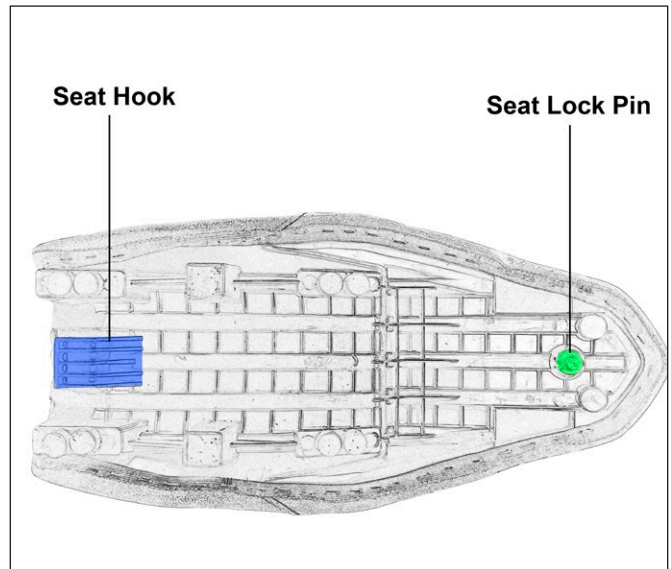

- Under the seat, there is a hook and a seat lock pin, which are both important to secure the seat onto the bike.

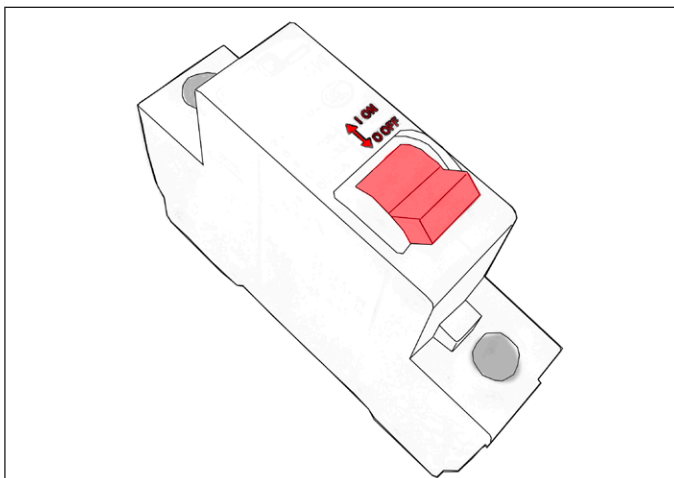

- To turn off the circuit breaker, please follow the marking on the circuit breaker, and switch the circuit breaker off.

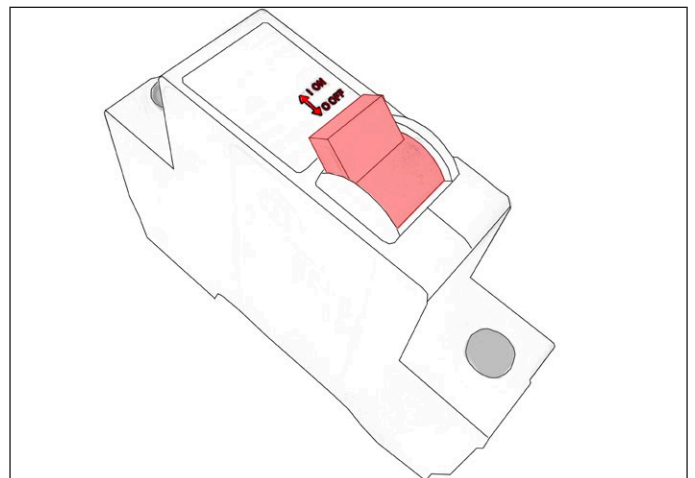

- Before you want to charge the bike/ use the bike, switch the circuit breaker on.

11. CIRCUIT BREAKER

location & instructions

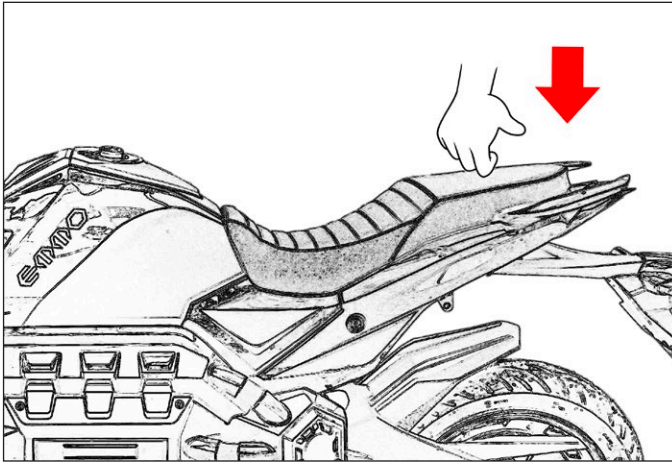

- Insert the seat hook into the U shape clamp on the bike, and gently push the seat cushion down to lock it.

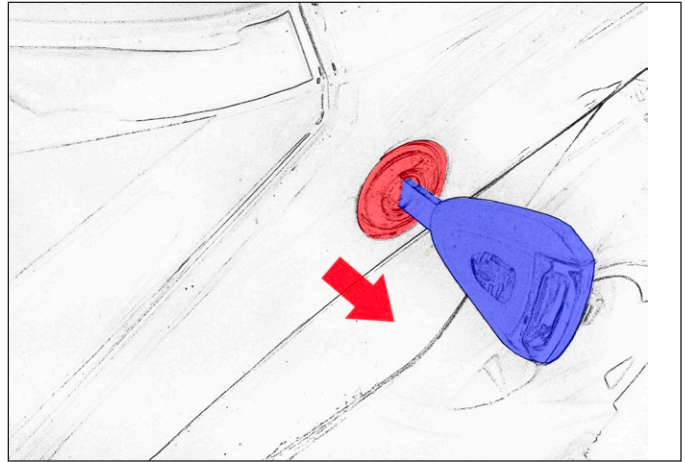

- Remove the key after the seat is locked.

TIP:

- Pay attention to the location of the seat lock pin under the seat. That is the pushing point when you lock the seat.

Warning:

- The wires inserted into circuit breaker could have high voltage output. DO NOT touch any bare wires. If you have any concern, contact your EMMO dealer for assistance.

12. HOW TO CHARGE

Charge the battery before the battery strength drops down to 20%. Before charging the bike, make sure you are using a compatible charger*. Failure to use a compatible charger will lead to danger.



- There are two cables coming out from the charger. One cable goes to the charging port on the bike, and the other goes to the regular 110V wall outlet.

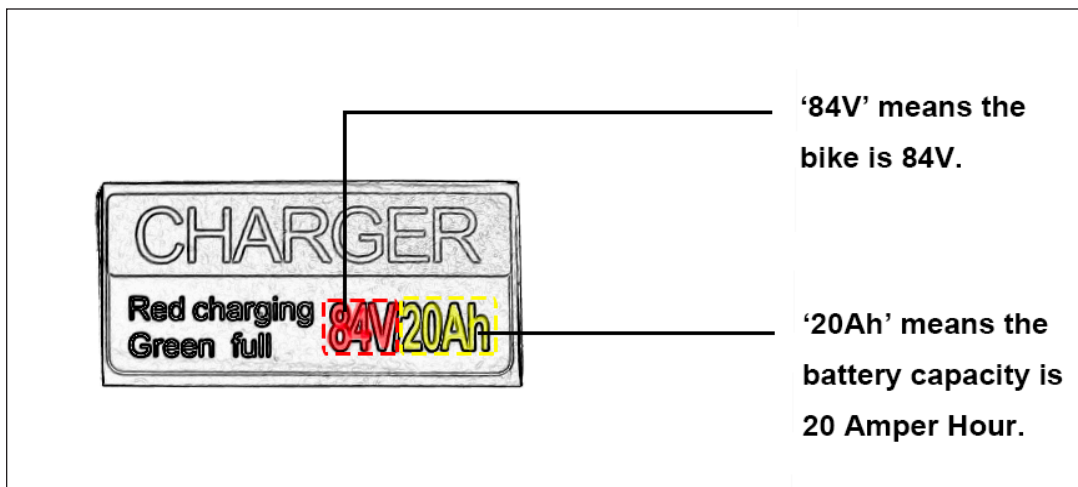

- On the charger, there is a sticker on the front indicating the voltage and capacity of the battery that the charger can be used for.

*Please refer to Appendix 1 for details of lithium battery and charger.

12. HOW TO CHARGE



- The charging port is below the front of the seat.

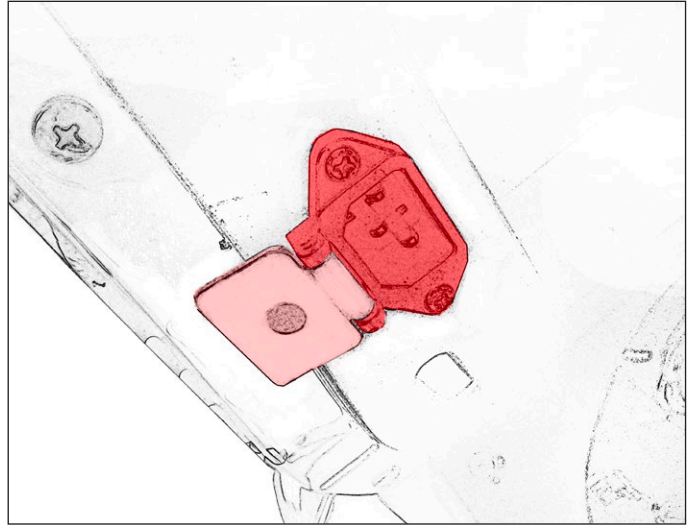

- To charge the bike, open the charging port lid and plug in the charger.

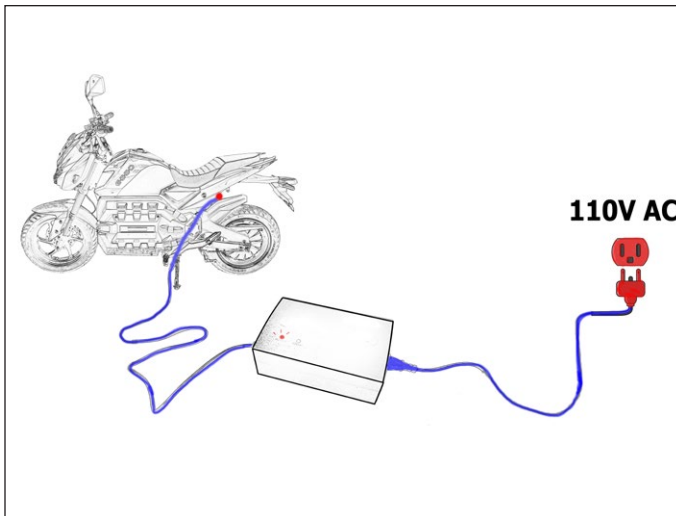

- Plug the charger into a regular 110V wall outlet.

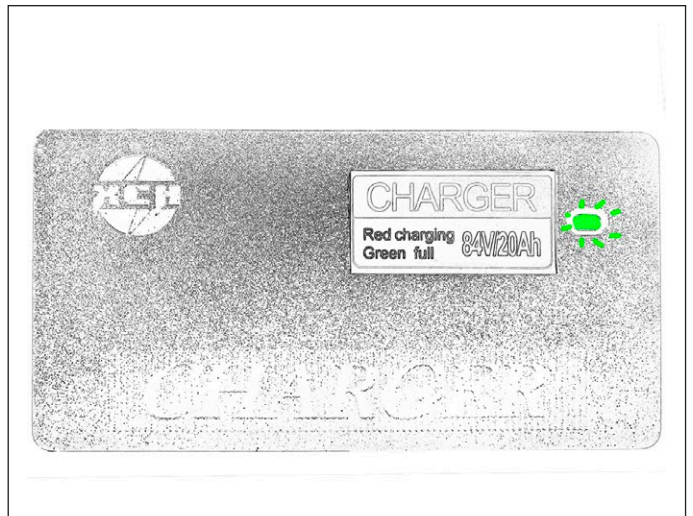

- Once fully charged*, unplug the charger from the wall outlet first and then unplug it from the bike.

*Please refer to Appendix 2 for more details of the indicators on chargers.

13. HOW TO RIDE THE BIKE

- Kick the side kickstand up (refer to page 15).

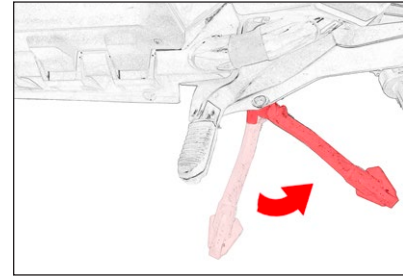

- Sit on the bike. Put on the helmet or any protective equipment required.

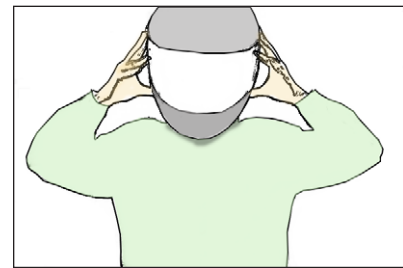

- With your feet still on the floor, turn the bike on (refer to page 19).

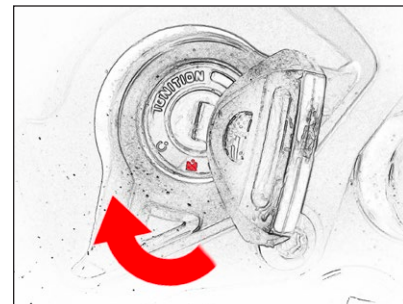

- When you are ready, turn the throttle and enjoy the ride.

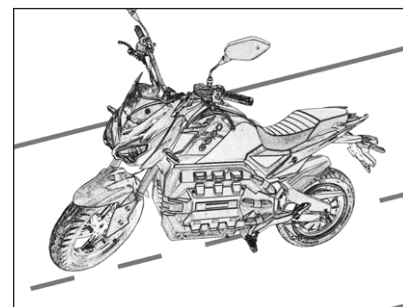

14. SAFETY INSTRUCTIONS

To ensure the safety of you and others,

- Do not ride after you take medications which may affect your riding ability, drink alcohol, or when you are unwell.
- Please make sure you are familiar with your local bylaw regarding e-bikes.
- Check the road conditions and weather conditions, so as to actively avoid danger.
- Wear necessary protective equipment, such as an helmet, if required by local by-law.
- Perform a basic inspection of the bike before the ride:

1. Battery strength: make sure that you have enough charge for the trip.

2. Tire pressure: on the casing side of the tire you will find the minimum and maximum pressure that applies to the tire. Insufficient tire pressure will affect the performance of your bike.

3. Brakes: check and make sure both brakes are in good working condition.

4. Lights/signals: make sure that headlight, signal lights, tail light and brake light are working well. Make sure you have a working rear reflector/ tail light if you need to ride the bike at night.

15. MAINTENANCE

Regular maintenance is required to keep the bike in its best working conditions.

CLEAN

Please use clean water and neutral detergent to clean the bike. Use soft cloths or sponges to clean the surfaces. Please do not use metal brushes, sandpaper or any other abrasive material to avoid scratches or physical damage. Dry the bike with soft cloths. Please clean and grease the chain and sprockets.

Warning:

- Please turn off the circuit breaker and remove the battery (if applicable) before cleaning the bike.
- DO NOT power wash the e-bike.

STORAGE

In case of storage of more than one month, such as winter storage, Please charge the battery regularly (at least once a month) and turn off the circuit breaker. The bike, including the battery and charger, is suggested to be stored in a clean, dry ventilated place. Please do not leave the battery outside under freezing temperature. Please avoid any corrosive material or heat source.

REGULAR INSPECTION

For **every 3000km** you travel or every **6 months**, a full inspection/tune-up is recommended based on the condition of the bike.

E-Bike Registration

E-Bike Registration

Once you have purchased an Emmo E-bike, you can register your vehicle with us to validate your warranty.

In order to register your e-bikes, please follow the steps listed below:

1. Fill out the following form:

Invoice Number: _____

Store Location: _____

Customer Name: _____

Address: _____

Phone Number: _____

E-mail: _____

Survey:

How did you find out about Emmo Inc.? (Please select the options that apply)

Returning Customer Family/Friend Passing by Store Kijiji
 TERA Google Yelp Other _____

2. Send the information listed above to our e-mail: info@emmo.ca

3. Wait for a confirmation e-mail from Emmo Inc.

APPENDIX 1

How to Charge a Lithium E-Bike

Most of the time, a lithium e-bike share the same look as a regular Gel Lead-Acid one. However, you will notice that the lithium battery is smaller in size and lighter in weight. The lithium charger is also different from ordinary Gel Lead-Acid chargers.

As shown in the follow picture, a typical lithium charger may consist of 2 parts:

1. *Main body with a cable that connects to the charging port of the bike.*
2. *A separate cable that connects the regular 110V wall outlet with the charger.*

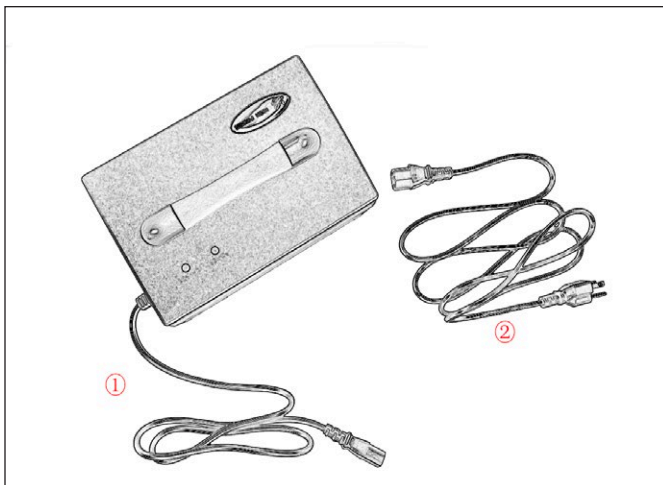

72V / 4.5A Lithium Charger

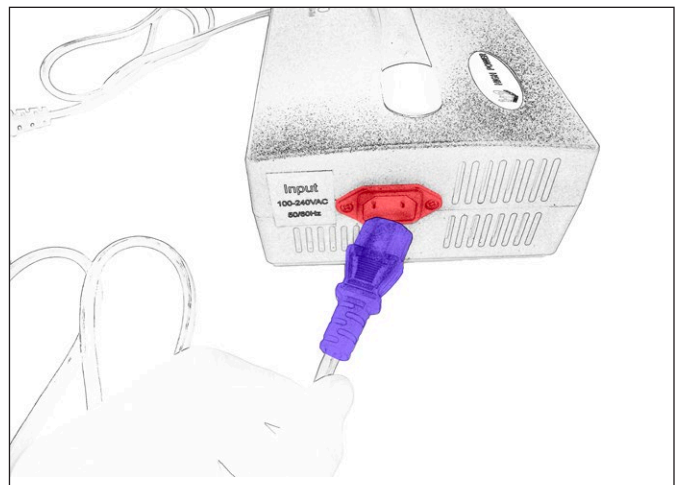

Plug the Separate Cable into the Charger

Before using the charger, you need to plug the individual cable into the charger. Same as Gel Lead-Acid versions, to charge the battery, plug the charger into the charging port of the bike. And then, plug the charger into a 110V outlet (refer to page 26).

Particularly, the lithium battery may be removable for the model. The lithium battery is located in the compartment behind the front wheel. Follow the following instructions to get access to the battery pack.

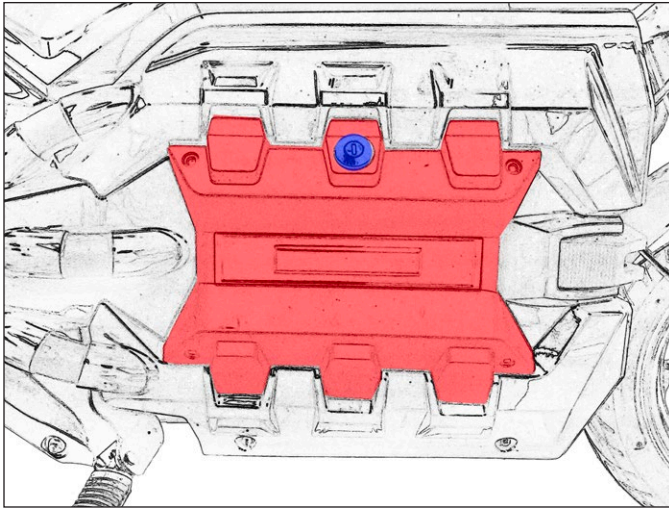

- The battery compartment lid is on the right side of the bike.

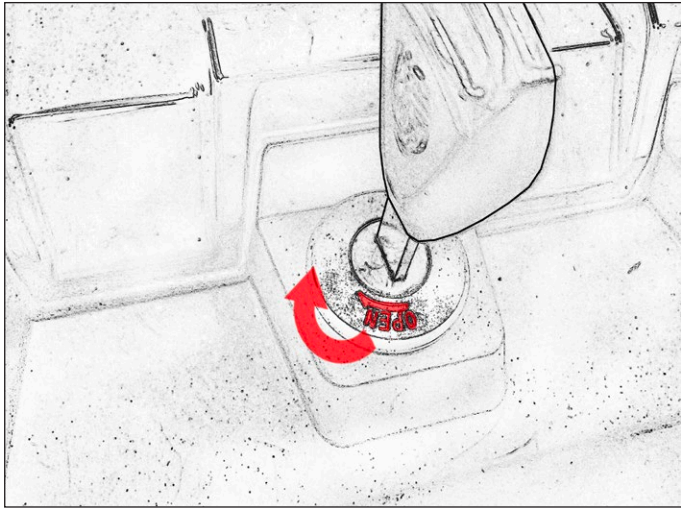

- Insert the key, and turn the key as indicated to unlock the lid.

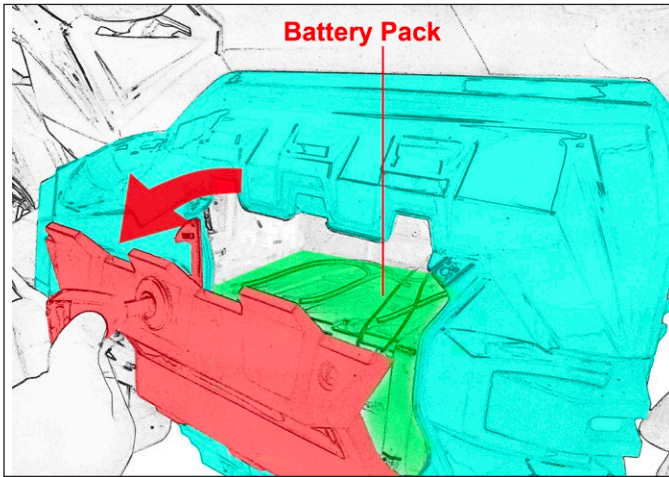

- Gently open the battery compartment lid.

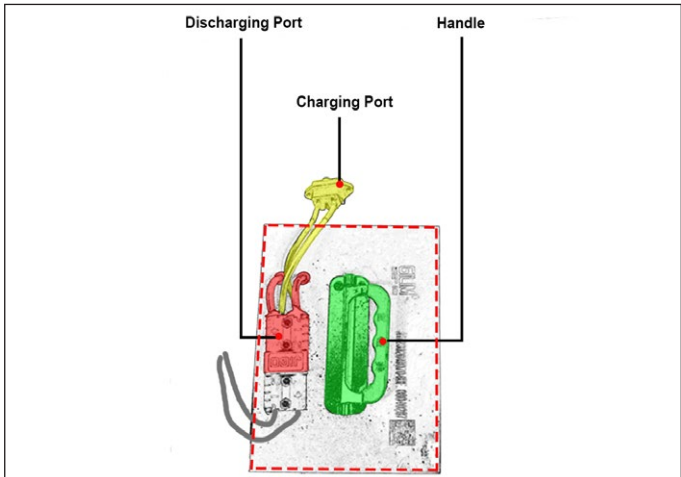

- There are usually two ports on a lithium battery: a charging port and a discharging port.

NOTE: The discharging port is connected to the main harness of the bike. The charging port will be used to charge the battery.

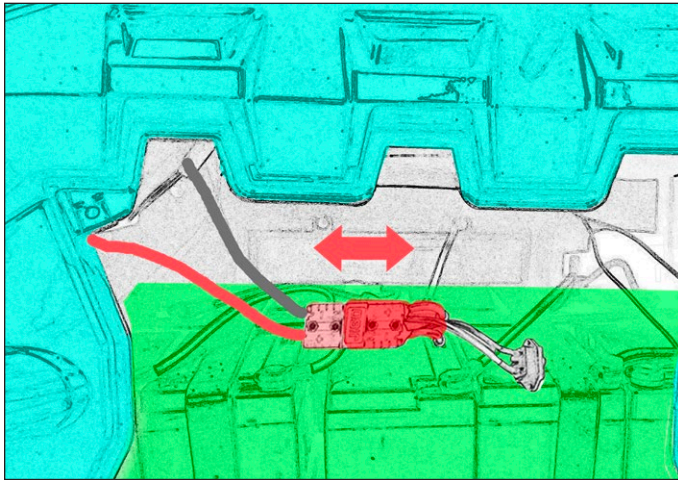

- Disconnect the battery discharging port from the bike, and remove the battery from the bike.

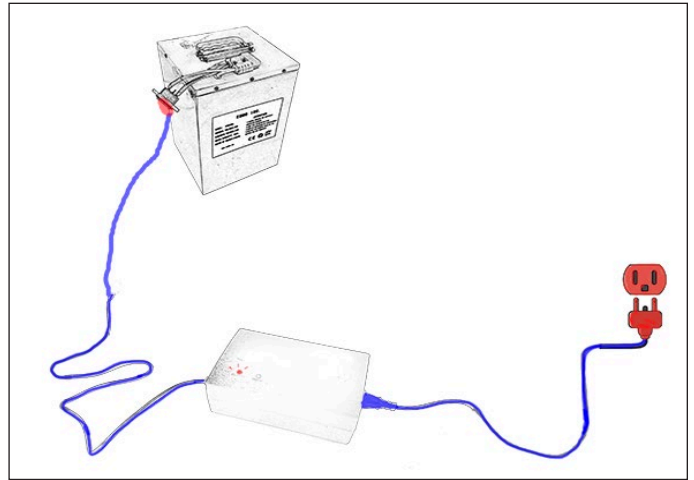

- Plug the charger directly to the battery and start charging.

Reminder:

- After putting the lithium battery back into the bike, remember to connect the discharging port with the bike.

APPENDIX 2

Charger Indicators

Usually, there is only one indicator on Gel Lead-Acid chargers. The indicator has only two colors - Red and Green. Red light means that the charger is charging the bike, while green light can show up when the battery is fully charged or when the charger is not connected to the bike properly. In other words, green light indicates the charger is not charging the battery/bike.

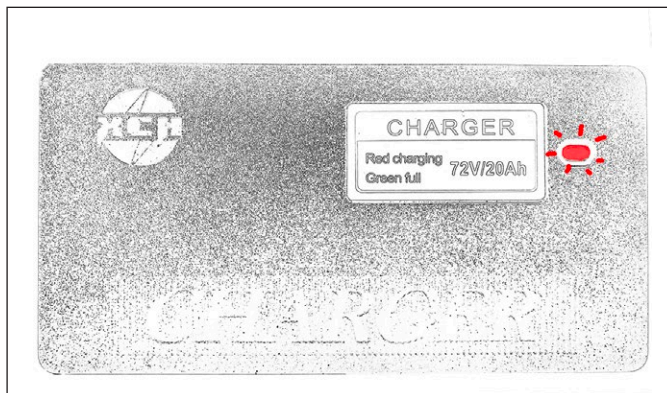

**Regular Charger with One Indicator
(Charging)**

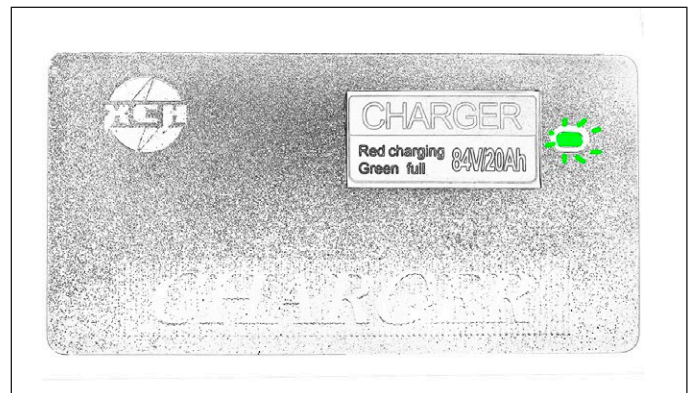

**Regular Charger with One Indicator
(Fully Charged)**

For some models, the lithium charger is similar to a Gel Lead-Acid one, with only one indicator and same indicating system.

However, for some lithium chargers, especially those with higher output, the charger is bigger in size and there are usually 2 indicators - the **POWER** indicator & the **CHARGE** indicator.

- The **POWER** indicator has only one color- red. When the red light comes on, it means the charger is connected to the power outlet.
- The **CHARGE** indicator shows the working status of the charger with different colors of light. Red light means the charger is not connected to the bike / battery properly. Amber light means the charger is charging the battery, and green light indicates the battery is fully charged.

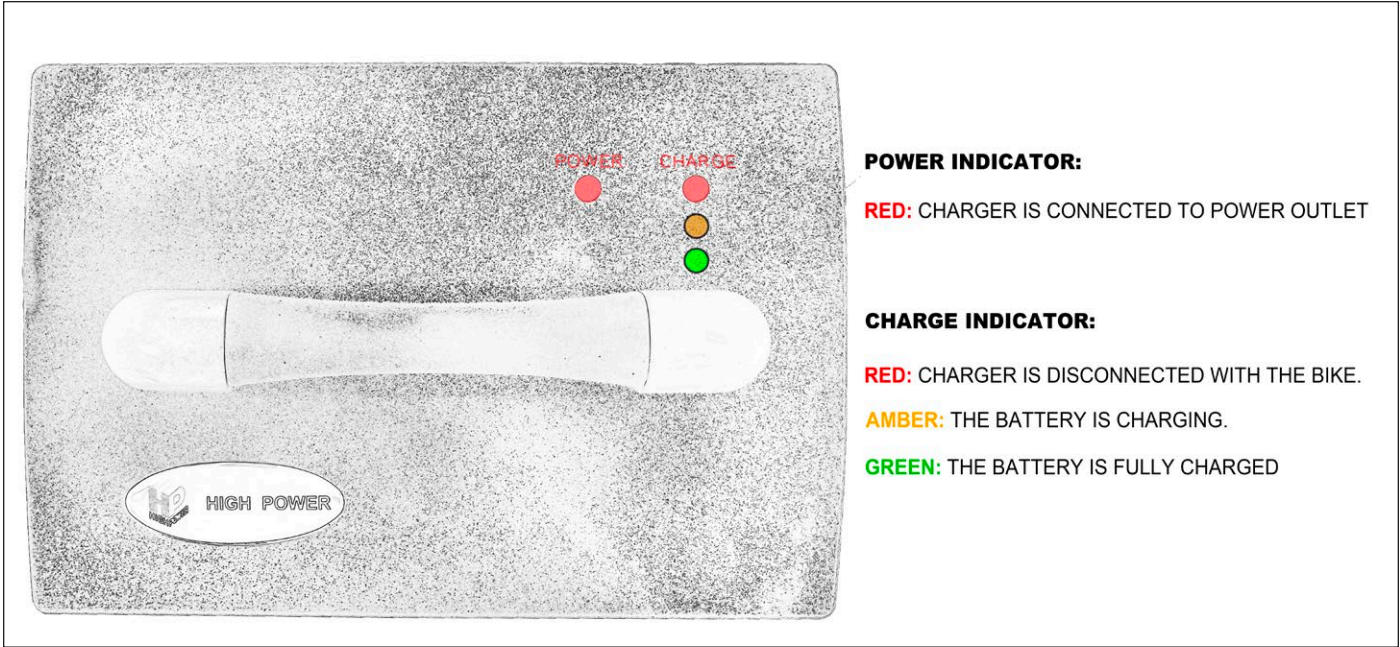

72V / 4.5A Lithium Charger Indicators