

PORTABLE INVERTER GENERATOR

i20/i25/i27/i30

Owner's Manual

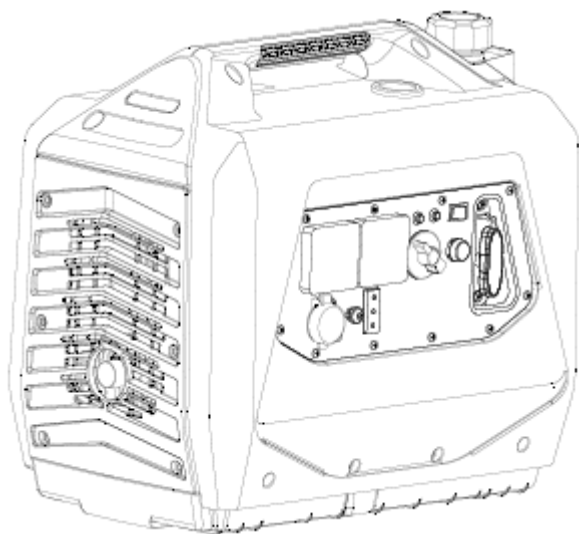

Portable inverter gasoline generator series

Owner's Manual

Introduction

Thank you for your purchasing of our generator.

This manual will provide you with a basic understanding of the operation and maintenance of this machine.

If you have any question regarding to the operation or maintenance of your machine, please consult your local dealer.



Read this manual carefully before operating this machine.

This manual should be provided together with this machine once sold.

Important information

Particularly important information is distinguished by the notations as follows:



This is the safety alarm symbol, which alerts you to potential personal injury hazards. Please obey all safety information in the symbol to avoid any possible injury or death.



WARNING: A WARNING indicates a hazardous situation, which will lead to severe injury or death if not avoided.

NOTICE: A NOTICE indicates special precautions to avoid damage to this machine or other property.

NOTE: A NOTE provides important information to simplify the operation.



WARNING:

PLEASE READ AND UNDERSTAND THIS MANUAL COMPLETELY BEFORE OPERATING THE MACHINE.

NOTE:

The manufacturer continually seeks advancements in product design and quality, therefore, although this manual contains latest products information when printed, there may be minor discrepancies in actual machine. There are also some changes in machine for different countries according to various requirement and regulations. If there is any question regarding to this manual, please consult your local dealer.

INDEX

WARRANTY	4
LOCATION OF IMPORTANT LABELS	4
SYMBOL MEANING	5
SAFETY INFORMATION	6
POISONOUS EXHAUST	7
HIGHLY FLAMMABLE AND POISONOUS FUEL.....	7
HOT ENGINE AND MUFFLER	8
ELECTRIC SHOCK PREVENTION.....	9
EXTENSION CORD NOTES.....	9
CONNECTION NOTES.....	10
DESCRIPTION	10
CONTROL PANEL	11
CONTROL FUNCTION	11
FUEL CONTROL SWITCH.....	11
ENGINE STOP BUTTON.....	11
ECO BUTTON.....	11
LOW OIL ALARM (YELLOW).....	12
OVERLOAD ALARM (RED).....	12
OUTPUT INDICATOR (GREEN).....	12
FUEL TANK CAP VENT KNOB.....	13
RESET BUTTON.....	13
PRE-OPERATION CHECK	13

FUEL	13
ENGINE OIL.....	14
GROUND TERMINAL.....	15
OPERATION	16
STARTING THE ENGINE.....	17
APPLICATION RANGE.....	18
AC CONNECTION	18
STOPPING THE ENGINE	21
PERIODIC MAINTENANCE	21
MAINTENANCE CHART.....	24
CARBURETOR ADJUSTMENT.....	25
SPARK PLUG INSPECTION.....	25
ENGINE OIL REPLACEMENT.....	26
FLAME RETARDANT ELEMENT AND SCREEN.....	26
AIR FILTER	27
FUEL TANK FILTER.....	28
TROUBLE SHOOTING.....	29
STORAGE	30
DRAIN THE FUEL.....	30
ENGINE.....	31
IDENTIFICATION	31
WIRE DIAGRAM	35
SPECIFICATIONS	32

WARRANTY

If doubt exists as to the cause and cure of a problem, consult your local authorized dealer. This is extremely important to the generator during the warranty period, as unauthorized, haphazard or improper repairs can void the warranty.

Remember that authorized local dealer has the special tools, techniques, and spare parts necessary for proper repair of your generator. Always consult him if you are in doubt as to proper specifications and/or maintenance procedures. Occasionally, printing errors or production changes will make certain portions of this manual incorrect. Until you are thoroughly familiar with this model, consult your local dealer before attempting any maintenance.

Should further maintenance or service information be desired, service manuals can be purchased from your local authorized dealer.

LOCATION OF IMPORTANT LABELS

Please read the following labels carefully before operating this machine.

NOTE: Maintain or replace safety and instruction labels, if necessary.

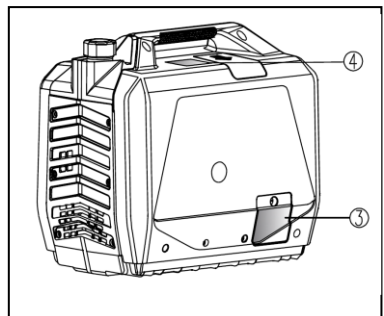
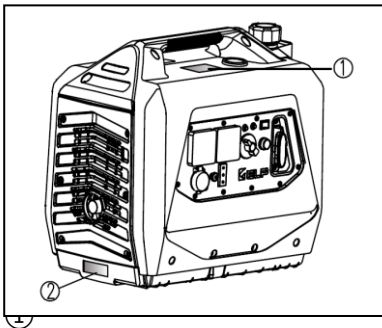

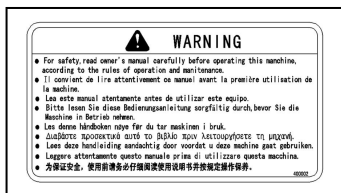

③

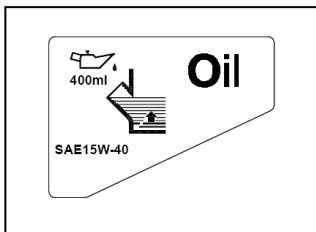

④

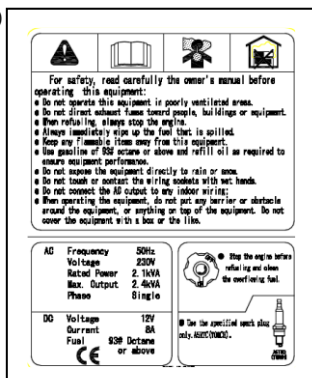

SYMBOL MEANING

Please understand the meaning of following symbols before operation.

(Refer to SAFETY INFORMATION for more details.)

The Safety Alert Symbol means:

Attention! Become alert! Your safety is involved!

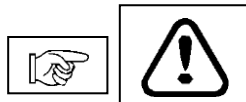

Read the manual before operation.

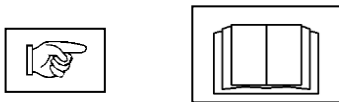

Be careful of poisonous exhaust.

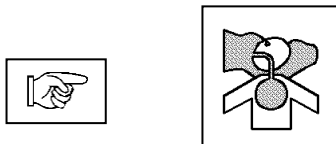

Never operate the machine
in a closed area.



Avoid touching hot surfaces,
such as engine and muffler.

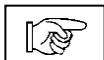

Ground (earth) terminal

Be sure to ground (earth) the generator.

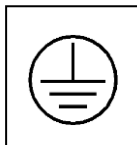
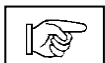

SAFETY INFORMATION

● This generator is not designed for marine-use.

Do not use it in a closed vehicle.

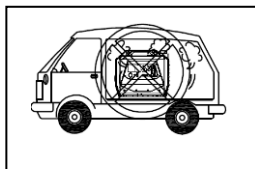

● Do not modify or use the generator
when any component removed.

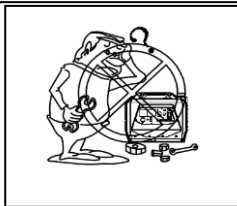

● Do not allow children to use the generator.



- Make sure to move the generator only by carrying its handle.

① Handle

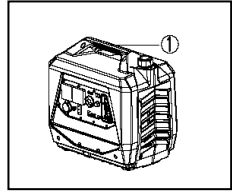

- Do not place any obstacle on the generator.

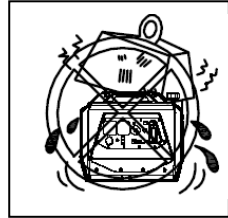

POISONOUS EXHAUST

- Never operate the engine in a closed area, or it may cause unconsciousness or death in a short time. Start the engine in a well-ventilated area.



HIGHLY FLAMMABLE AND POISONOUS FUEL

- Always shut the engine when refueling.
- Never refuel when smoking or near an open flame;
- Be careful not to spill any fuel on the Engine or muffler when refueling;

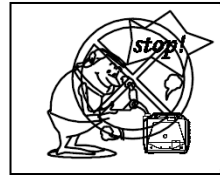

- If you carelessly swallow any fuel, inhale fuel vapor, or allow any fuel into your eye, please go to hospital immediately. If you spill any fuel on skin or clothing, please wash it with soap and water immediately, and change clothes.



- When use or move generator, please keep it vertically and upright. If it tilts, there may be fuel leakage from carburetor or fuel tank. Meanwhile, during transportation, make sure to keep fuel tank cap tightened, and vent knob on OFF.

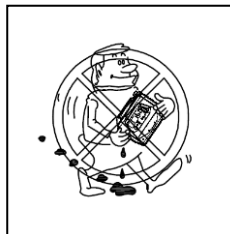

HOT ENGINE AND MUFFLER

- Place the generator in a place where Pedestrians or children can not reach.
- During operation, avoid placing any flammable material near the exhaust outlet.

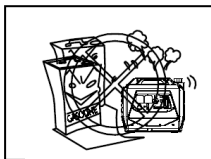
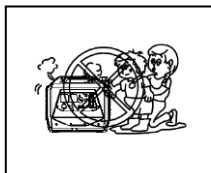

- Keep the generator at least 1 meter (3 feet) distance from building or other equipments, if not, the generator may be overheated.

@ 1 meter (3 feet)

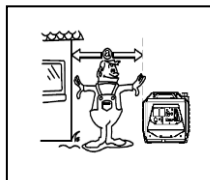

- Do not operate the generator when a dust cover or other stuff covered.

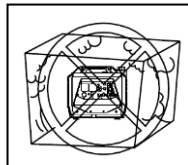

- Make sure the engine and muffler are completely cooled down, when covering the generator.

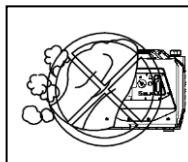

ELECTRIC SHOCK PREVENTION

- Never operate the generator in rain or snow to avoid electric shock.
- Never touch the generator with wet hands, or electric shock will occur.
- Connect the ground line of generator with ground (earth) terminal, and the other end to the ground electrode buried in the ground.

① Ground (earth) terminals

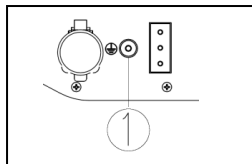
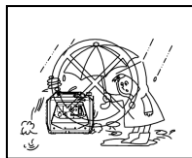

EXTENSION CORD NOTES

- When using a 1.5 mm² extension cord, the cord length should not exceed 60m. When using a 2.5 mm² extension cord, the cord length should not exceed 100m.
- The longer the extension cord is, the more reduction of voltage between the generator output socket and the load connection will be. Therefore, choose an extension cord with an appropriate length.
- This extension cord should be protected by a tough and flexible rubber sheath (IEC245) or other equivalent stuff.

CONNECTION NOTES

- Avoid connecting the generator to commercial power socket.
- Avoid connecting the generator without parallel function in parallel with any other generator.

(Connect the generator with parallel function as per instruction).

- ① Correct ② Incorrect

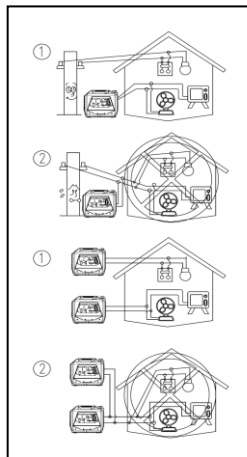

WARNING:

Before the generator can be connected to a building's electric system, a licensed electrician must install an isolation (transfer) switch in the building's main fuse box. The switch is the connection point for generator power and allows selection of generator power or main line power to the building. This will prevent the generator from charging the main power line (back feeding) when the main power supply has failed or has been turned off for a line repair. Back feeding can electrocute or injure line maintenance personnel. Also generator and building electrical system damage can occur when normal operation power returns if unit is used without an isolation switch.



WARNING:

Before transportation or moving, if the generator may involve in overturn or dumping, fuel inside fuel tank or engine oil inside engine crankcase should be drained.

DESCRIPTION

- ① Vent knob, fuel tank cap
- ② Fuel tank cap
- ③ Fuel tank
- ④ Fuel level sensor Assy.
- ⑤ Handle
- ⑥ Recoil starter handlebar
- ⑦ Control panel
- ⑧ Muffler
- ⑨ Engine oil cover
- ⑩ Cover, carburetor drain screw
- ⑪ Air filter cover
- ⑫ Spark plug cover

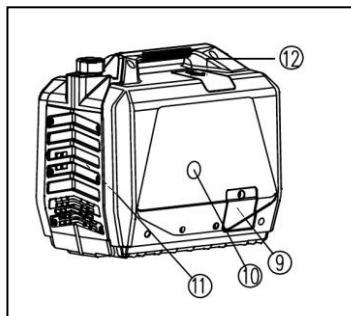
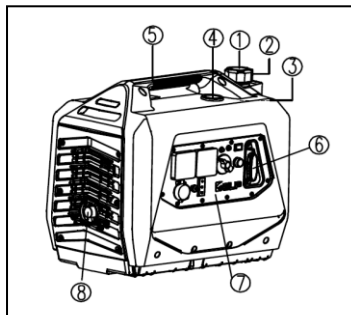

CONTROL PANEL

- ① ECO switch
- ② Reset button (green)
- ③ Engine stop button (red)
- ④ AC socket
- ⑤ Cig. Socket or USB port
- ⑥ Ground (earth) bolt/nut
- ⑦ Output indicator
- ⑧ Low oil alarm indicator
- ⑨ Overload alarm indicator

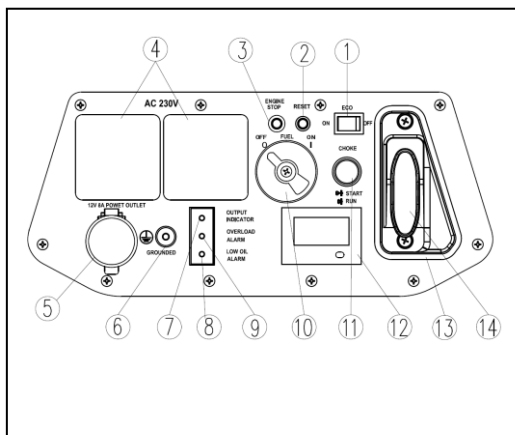

- ⑩ Fuel switch
- ⑪ Choke cable
- ⑫ LCD screen(optional)
- ⑬ Limit box, recoil starter handlebar
- ⑭ Recoil starter handlebar

CONTROL FUNCTION

FUEL SWITCH

- ① “OFF”, Fuel supply is off;
- ② “ON”, Fuel supply is on,

ENGINE STOP BUTTON (RED)

When the generator works, press this button for 2-3s,
the ignition circuit gets off and generator stops.

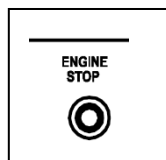

ECO SWITCH

- ① “ON”

When ECO switch is in position ON, economic
control unit will automatically adjust the engine speed according
to the connected load, so as to achieve low fuel consumption and low noise.

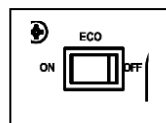

- ② “OFF”

When ECO switch is in position OFF, no matter there is a load connected or not,
engine will run at rated speed (4200r/min).

NOTE:

ECO switch must be in position OFF when applying to electric devices that require a large starting current, such as compressor or submersible pump.

LOW OIL ALARM (YELLOW)

When engine oil level falls below the Lower level, low oil alarm will be on, and engine will stop automatically. Unless you refill engine oil, engine will not be started again.

- ① Engine oil alarm
- ② Overload alarm
- ③ Output indicator

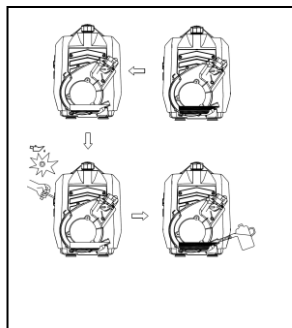
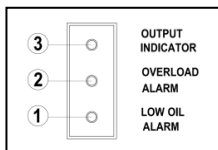

NOTE

If engine can not be started, please quickly pull the recoil starter for several times. If low oil alarm light flickers for a few seconds (yellow), it means engine oil is insufficient. Add engine oil to the required level and restart the generator.

OVERLOAD ALARM (RED)

When the detected total power of connected electrical devices is close to rated power, the Overload alarm light (RED) ② will be ON and blinks.

The overload alarm light (RED) ② will be always ON (Red)

when detected power of all connected electrical devices is overloaded. The electrical breaker will activate to stop the power generation in order to protect the generator and connected electric devices. The AC output indicator (green) will be OFF, and the overload alarm light (red) will stay ON, but the generator will not stop running (in idle speed).

When the overload indicator light is ON, and has no power output, proceed as follows:

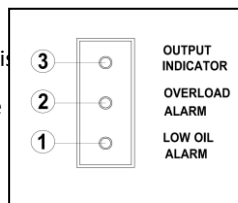

Disconnect all electric devices, reduce total wattage of connected electric devices within the application range, and press the reset button ④ (green), generator will recover power output.

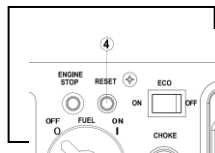

NOTE:

- Generator output automatically resets, when engine is stopped and then restarted.
- Overload indicator light may be ON for seconds at first when using electric devices that require a large starting current, such as compressor or submersible pump, but this is not a malfunction.

OUTPUT INDICATOR (GREEN)

When engine is started and output power, the output indicator is ON.

③ Output indicator

FUEL TANK CAP VENT KNOB

Fuel tank cap has a vent knob to balance inner and outer pressure of fuel tank, and stop fuel overflow.

Turn vent knob clockwise from OFF to ON to allow fuel flowing into carburetor so as to run the generator.

When generator stopped or moved, turn vent knob counterclockwise from ON to OFF to avoid possible fuel overflow or vapor.

① Vent knob

② Fuel tank cap

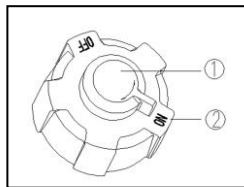

RESET BUTTON (GREEN)

When generator stops output due to overload, disconnect all electric devices, reduce total wattage of connected electric devices within the application range, and press the reset button ④, generator will recover power output.

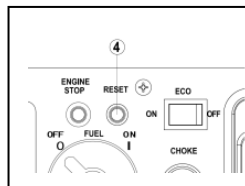

④ Reset button

PRE-OPERATION CHECK

NOTE:

Pre-operation checking should be made each time before using generator.

FUEL



WARNING:

- Fuel for the generator is highly flammable and poisonous. Check SAFETY INFORMATION (see page 7) carefully before refueling.
- Do not fill over the fuel filter, if not it may overflow when the fuel heats up and expands.
- Make sure to tighten the fuel tank cap after refueling.

NOTICE:

- Use clean and dry soft cotton cloth to wipe any spilled fuel, to avoid corrosion on parts surface or plastic parts.
- Must use unleaded fuel to avoid serious corrosion on engine inner components.

Open fuel tank cap, fill with fuel till red mark inside fuel filling screen.

Recommended fuel:

Unleaded gasoline : #92 or above;

Fuel tank capacity: 5.0L (1.3 US gal, or 1.1 Imp gal)

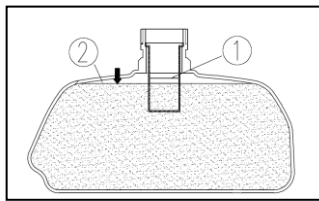

① Red mark; ② Fuel level

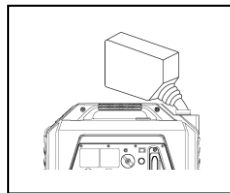

WARNING:

GROUND (EARTH) TERMINAL

Make sure ground (earth) terminal of generator

connected to avoid electric shock. When

electric device is applied, generator should connect with earth ground.

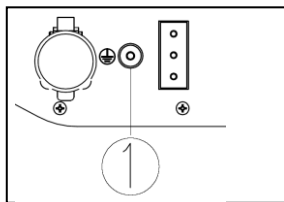

① Ground (earth) terminal

OPERATION



WARNING:

- Never operate the generator in a closed area or it may cause unconsciousness or death within a short time. Operate the generator in a well ventilated area.
- Before starting the engine, do not connect any electric device.
- Clean dust, dirt or water off the socket before use.

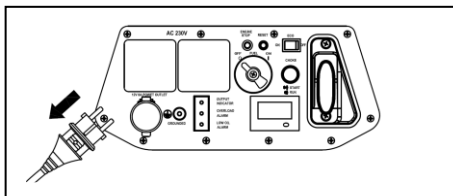

NOTICE:

- The generator leaves factory without engine oil. Generator will be protected for non-start without sufficient engine oil filled.
- Do not tilt the generator when filling engine oil, which may result in overfilling and damage to the generator.

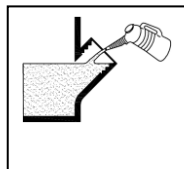

NOTE:

- Generator can be used at rated output load in standard atmospheric conditions as follows:

Ambient temperature: 25 °C

Atmospheric pressure: 100KPa

Relative humidity 30%

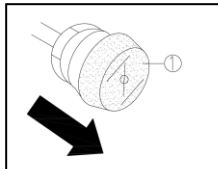

- The generator output will differ due to change in temperature, altitude (the higher altitude, the lower air pressure) and humidity. The generator output will reduce, when temperature, humidity and altitude are higher than standard atmospheric condition.
- In addition, please reduce the load in a confined area, as generator cooling is affected.

STARTING THE ENGINE

1. Hold the fuel tank cap to avoid its moving, and turn vent knob clockwise from OFF to ON, so as to open the vent hole.

① Vent knob

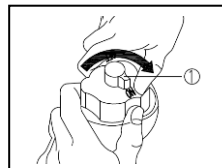

2. Turn the fuel switch to position ON.

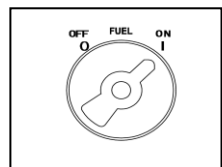

3. Pull out choke cable button completely.

① Choke cable button

NOTE:

No need to use choke cable to start a warm engine. Press the choke button back to original position.

4. Pull slowly on the recoil starter handlebar until it is tightened, and then pull it hard.

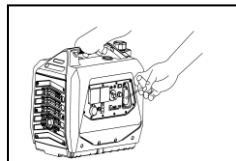

NOTE:

Grasp the generator carrying handle firmly to prevent the generator from falling over when pulling the recoil starter.

5. After engine is started, warm up the engine until engine does not stop when the choke button is back to original position.

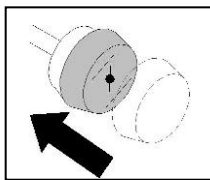

NOTICE

Choke cable button should be back to original position when generator works normally, otherwise generator will not work well.





NOTE

When starting the engine, place ECO switch in position OFF and there is no load on the generator.

- In ambient temperature below 3°C (37°F) , engine should run at rated speed for 5 minutes to warm up.
- In ambient temperature above 3°C (37°F) , engine should run at rated speed for 3 minutes to warm up.
- After engine warm-up, place ECO switch in position ON, and run the generator in economy status.

APPLICATION RANGE

When using the generator, please make sure total load is under the range of generator rated output, or the generator may be damaged.

A AC				D DC
B Power factor	1	0.8–0.95	C 0.4–0.75 (Efficiency 0.85)	
2000	1800VA	1440VA	612VA	E Rated voltage 12V Rated current 8A
2500	2100VA	1680VA	714VA	Rated voltage 12V Rated current 8A

NOTE:

When total watts exceed the application range, the overload alarm indicator ② is on (red)
(See page 17 for more details.)

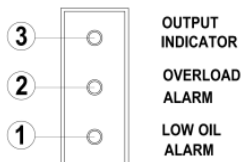

NOTICE:

- Make sure the total load is in the range of generator rated output, otherwise generator damage will occur.
- The simultaneous usage of AC and DC power is possible, but total watts should not exceed the rated output, otherwise generator damage will occur.

SERIES		20i	25i
GENERATOR RATED POWER		1800VA	2100VA
	POWER FACTOR		
AC	1	1800VA	2100VA
	0.8	1440VA	1680VA
DC		96W (12V/8A)	96W (12V/8A)

NOTICE

- Do not overload. The total load of all electrical appliances must not exceed the supply range of the generator. Overloading will damage the generator.
- When supplying precision equipment, electronic controllers, PCs, electronic computers, microcomputer-based equipment or battery chargers, keep the generator a sufficient distance away to prevent electrical interference from the engine. Also ensure that electrical noise from the engine does not interface with any other electrical devices located near the generator.
- If the generator is to supply medical equipment, advice should first be obtained from the manufacturer, a medical professional or hospital.
- Some electrical appliances or general-purpose electric motors have high starting currents, and cannot therefore be used, even if they lie within the supply ranges given in the above table. Consult the equipment manufacturer for further advice.

AC CONNECTION



WARNING

Be sure all electric devices are turned off before connection.

NOTICE:

1. Be sure all electric devices including lines and plugs connections are in good condition before connecting to generator.
2. Be sure the total load is within generator rated output.
3. Be sure the socket load current is within socket rated current.

NOTE:

Make sure generator is connected to ground earth.
When electric device is connected to ground earth, generator should be connected to the ground.

1. Start the generator.
2. Connect the plug with the AC socket.

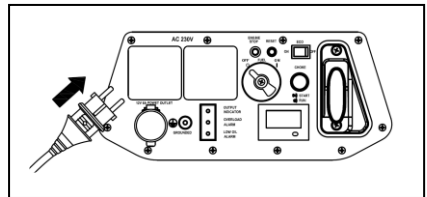

3. Make sure the AC output indicator is ON (Green).

③ AC output indicator

4. Turn the ECO switch to the position ON, and then turn on all electric devices.

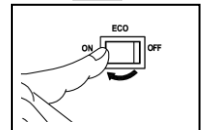
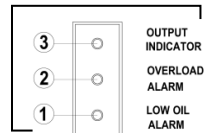

NOTICE

When using electric devices that require a large starting current, such as compressor or submersible pump, the ECO switch must be placed in position OFF.

STOPPING THE ENGINE

NOTE:

1. Disconnect all electric devices.
2. Place ECO switch in position OFF.

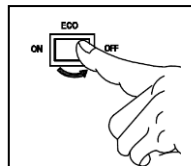

1. Disconnect all electric devices.

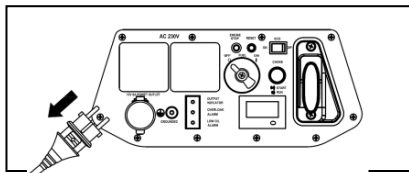

2. Press the engine stop button for 2-3s, and the engine will be shut completely.

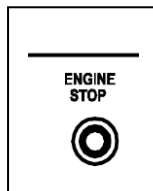

3. Turn the fuel switch to position OFF

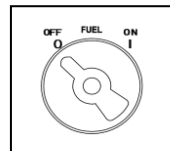

4. Turn the vent knob to position OFF after the engine is completely cooled down.

① Vent knob

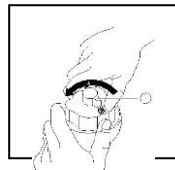

PERIODIC MAINTENANCE

Safety is owner's obligation. Periodic inspection, adjustment and lubrication will keep your generator in long-term, safe and efficient condition. The key points of periodic inspection, adjustment and lubrication are explained on the following pages.



WARNING:

If you are not familiar with maintenance work,
please consult the local dealer.

MAINTENANCE CHART



WARNING: Stop the engine before starting maintenance work.

NOTICE:

Use only specified genuine parts for replacement. Ask the authorized dealer for further information.

Item	Routine	Pre-operation check	Every 6 months or 100 hour	Every 12 months or 300 hour
Spark plug	Check condition Clean and replace if necessary		○	
Fuel	Check fuel level and leakage	○		
Fuel hose	Check fuel hose for cracks or damage. Replace if necessary.	○		
Engine oil	Check oil level in engine	○		
	Replace		○(1)	
Air filter element	Check condition		○(2)	
	Clean			
Flame retardant element	Check condition Clean and replace if necessary		○	
Fuel screen	Clean and replace if necessary			○
Crankcase breather hose	Check breather hose for cracks or damage. Replace if necessary.			○
Cylinder head	Decarbonizes cylinder head More frequently if necessary			★
Valve clearance	Check and adjust when engine is cold.			★
Fittings/ fasteners	Check all fittings and fasteners. Correct if necessary.			★
The point where abnormality was recognized by use.		○		

Instruction:

1. Initial replacement of engine oil is after one month or 20 hours of operation.
2. Air filter element needs to be cleaned more frequently when using in unusually wet or dusty areas.

Since these items require special tools, data and technical skills, please have the dealer do it for you.

CARBURETOR ADJUSTMENT

Carburetor is key part of engine. Please have your local dealer qualified with professional knowledge, special materials and special equipment adjust it for you, to make sure correct adjustment.

SPARK PLUG INSPECTION

1. Remove spark plug cover and spark plug cap.

- ① Spark plug cover
- ② Spark plug cap

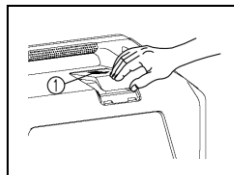

2. Locate spark plug socket on spark plug, turn it clockwise with wrench, and then disassemble spark plug.

- ③ Spark plug socket
- ④ Spark plug

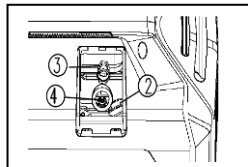

3. check for discoloration and remove the carbon.

Standard electrode color: Medium-to-light tan color

4. Check spark plug type and clearance.

Standard spark plug: A5RTC (TORCH)

Spark plug clearance: $a=0.6\text{mm}$

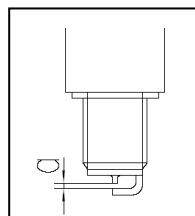

5. Install spark plug.

Spark plug torque: 12~15N.m

NOTE: When installing spark plug, twist it for 2-3 rounds by hand, and lock it up with specified torque value.

6. Install spark plug cover.

ENGINE OIL REPLACEMENT



WARNING:

Never drain engine oil immediately shut the engine to avoid scald.

1. Place generator on a level surface, and start engine for several minutes to reduce the engine oil viscosity. Then shut the engine, and turn the fuel tank cap vent knob to position OFF.

2. Loose screw and remove oil filling cover.

- ① Screw
- ② Oil filling cover

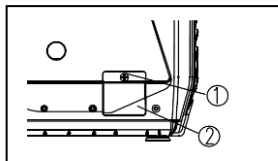

3. Remove oil drain plug, place an oil pan under the engine, and tilt the generator to drain the oil completely.

- ③ Oil drain plug

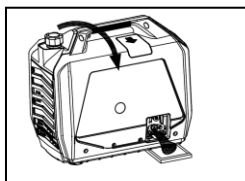
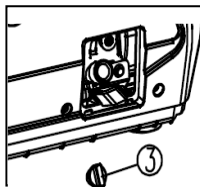

4. Place the generator on a level surface and add engine oil to lower level of filter port.

- ④ Lower level

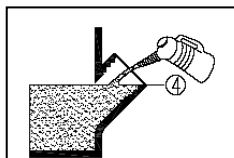

NOTICE:

Do not tilt the generator when filling engine oil. This would result in overfilling and damage to the generator.
Be sure no other material enters the engine crankcase.

Recommended engine oil: (See page 15)

5. Wipe any spilled oil around filter port, and tighten refill plug to engine filter port.
6. Install oil filling cover, and tighten screw.

FLAME RETARDANT ELEMENT AND SCREEN



WARNING:

- The engine and muffler will be very hot, after running the engine.
- Avoid touching engine and muffler directly with any part of your body or clothing during inspection and repair.

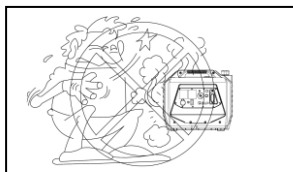

1. Remove screws on both sides, and disassemble exhaust cover.

- ① Screw
- ② Exhaust cover

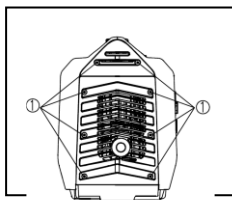

2. Loosen clamp, and remove flame retardant element locking cap.

- ③ Clamp
- ④ Locking cap

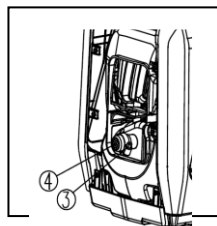

3. Use a wire brush to remove carbon deposits from flame retardant element and screen.

⑤ Flame retardant element

⑥ Screen

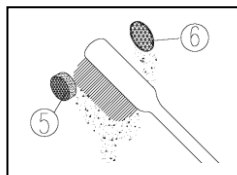

NOTICE:

When cleaning, use the wire brush lightly to avoid damaging or scratching flame retardant element.

4. Check the flame retardant element and screen. Replace them if damaged.
5. Install flame retardant element and screen into locking cap, and then to muffler, with clamp to tighten them.
6. Install exhaust cover, and tighten the screws on both sides.

AIR FILTER

1. Loosen screws and remove air inlet cover.

① Screw

② Air inlet cover

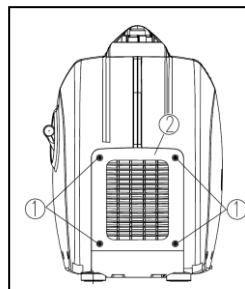

2. Loosen screw, remove air filter cover, and take out filter element.

③ Screw

④ Air filter cover

⑤ Filter element

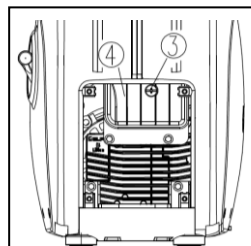

3. Wash the filter element with solvent and dry it.

4. Add 5g engine oil to element, and squeeze out excess oil.

The element should be wet, but not dripping.

Recommended filter oil:

Foam-air-filter oil or SAE#20 lubricant oil.

NOTICE

Do not wring out the element sponge or it will be damaged.

5. Insert the element into air filter.

NOTE:

Be sure the element sealing surface matches the air filter so as not to leak air.

NOTICE:

Never run the engine without element or it may cause excessive poisonous gas and cylinder wear.

6. Install air filter cover, and tighten it with screws.

NOTE:

When installing air filter cover, check and place the sealing strip on air filter correctly.

7. Assembly air intake cover, and tighten screws.

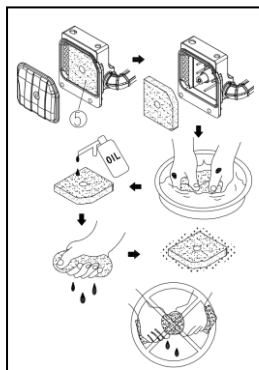

FUEL TANK FILTER

1. Open fuel tank cap, and take out fuel inlet filter screen; Loosen the mounting bolt and put down the fuel switch and the O-ring seal ;

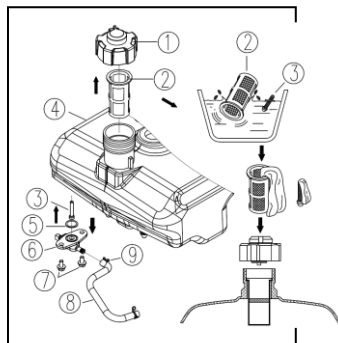

Loosen the fuel inlet line of the carburetor and the clip, take out fuel outlet filter screen.

- ① Fuel tank cap
- ② Fuel inlet filter screen
- ③ Fuel outlet filter screen
- ④ Fuel tank
- ⑤ O-ring seal
- ⑥ Fuel control switch
- ⑦ Bolt
- ⑧ Fuel inlet line, carburetor
- ⑨ Clip

2. Clean the fuel inlet filter screen and fuel outlet filter screen with gasoline. Replace it if damaged.

3. Wipe fuel inlet filter screen and outlet filter screen, and install them into fuel tank inlet port and outlet port.

4. Check if the O-ring seal is damaged or aging. Replace it if any abnormality occurred.

5. Install fuel tank cap and tighten it. Assemble fuel outlet line in correct position and tighten it with the clip.



WARNING:

- Make sure to tighten fuel tank cap, and fuel line clip.
- Replace the O-ring seal if any damage or aging occurred.
- Tighten the mounting bolt of the fuel control switch.

TROUBLESHOOTING

Engine can't be started

1. There is no fuel or enough fuel in the tank.

- Check fuel sensor assy:

When the pointer of fuel gauge is in position

①, please add fuel; when the pointer is in position ②, it means the fuel is enough and no need add fuel(please see page xx for fuel adding.)

- If the fuel is enough in the tank, please check vent knob on fuel tank cap, and turn it to position ON.
- Check the fuel control switch and turn it to position ON.
- Clogged fuel line: Clean fuel line.
- Clogged carburetor: Clean carburetor.

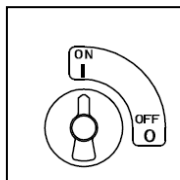
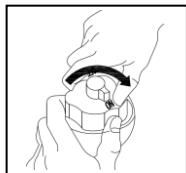
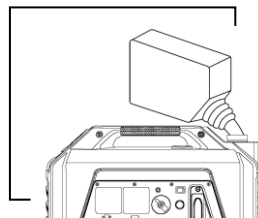
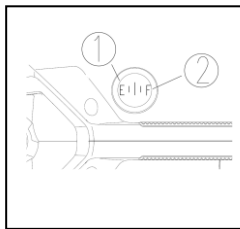

2. Low engine oil level:

Add engine oil to specified position.

(see page 14xx)

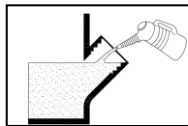

3. Poor spark

- Spark plug is dirty with carbon or wet:

Remove carbon or wipe and dry spark plug.

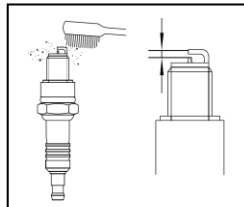

- Check spark plug clearance 0.5~0.7mm:

Replace it if there is over tolerance.

- Faulty ignition system: Consult the local dealer.

Generator has no output

Overload, no output from generator

- Disconnect all electric devices, reduce total wattage of connected devices within the application range, and press the reset button ②.

②Reset button(green)

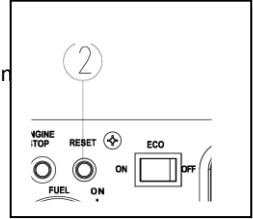

STORAGE

Long term storage of your machine will require some preventive procedures to guard against deterioration.

DRAIN THE FUEL

1. Remove fuel tank cap. Drain the fuel from fuel tank into an approved gasoline container by a commercially available hand siphon. Then install fuel tank cap.
2. Remove carburetor drain cover, loosen the drain screw on the carburetor float chamber, and drain the fuel from carburetor into an approved gasoline container.

① Drain screw

② Carburetor drain cover

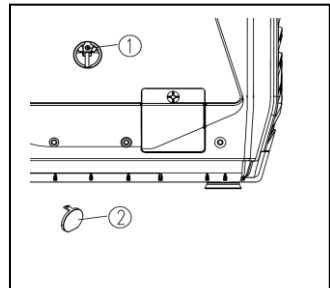

3. Tighten carburetor drain screw, and install carburetor drain cover.



WARNING:

- Fuel used in the machine is highly flammable and poisonous. Check **SAFETY INFORMATION** (see page 7) carefully before adding the fuel.
- Make sure to wipe up any spilled fuel immediately to avoid damage on rubber or plastic parts.

4. Start the engine and leave it run in empty load until it automatically stops without any remaining fuel in carburetor.

ENGINE

In order to protect engine inside cylinder, piston rings and other parts, please proceed as following steps:

1. Remove the spark plug, and pour about one spoon SAE10W\30 or 20W\40 engine oil into the spark plug, and then install the spark plug. Pull the recoil starter for several times to coat the cylinder wall, piston rings and other parts with engine oil.
2. Pull the recoil starter until you feel compression and then stop pulling (This prevents the cylinder and valves from rusting).
3. Clean the exterior part of the generator.
4. Store the generator in a dry and well-ventilated place, with a clean cloth covered.
5. The generator must remain in a vertical position when stored, carried and operated.

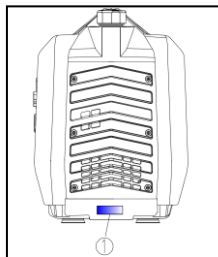

IDENTIFICATION

MACHINE IDENTIFICATION for 2000i/2500i series

The machine identification series number is attached in the location as shown in drawing.

- ① Machine series number

WIRE DIAGRAM

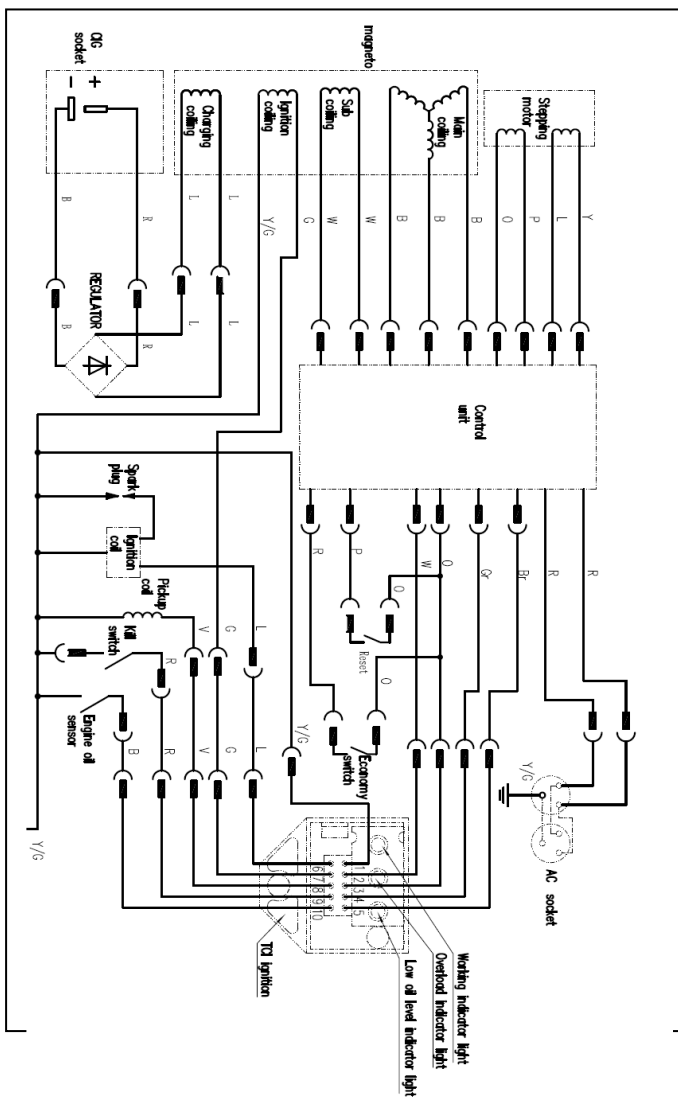

SPECIFICATION

Item	Unit	20i series	25i series	27i series
Engine model		LH148F	LH148F-G	LH148F-G
Engine type	4 stroke, air-cooled, single cylinder, OHV gasoline engine			
Displacement	ml	79	79	79
Rated power	kW	2.3	2.6	2.6
Engine oil	ml	400	400	400
AC rated voltage	V	230/120	230/120	230/120
AC rated current	A	7.8/15	9.1/17.5	9.1/17.5
Frequency	Hz	50/60	50/60	50/60
AC rated output	VA	1800	2100	2100
AC max. output	VA	2000	2400	3000
Power factor		1.0	1.0	1.0
Fuel tank capacity	L	5.0	5.0	5.0
Noise level *	dB/LWA	52—59	52—59	52—59
DC rated voltage	V	12	12	12
DC rated current	A	8	8	8
Dimension	mm	500X315X438	500X315X438	500X315X438
N.W.	Kg	19.8	19.8	19.8

★ Noise level is measured when the ECO switch is ON.

LWA shows the sound power level under the ISO3744 standard test condition.

The noise level in dB (A)/7M is the arithmetic mean value in four directions measured 7 meters away from each side of the generator.

The noise level may vary in different environments.

★ NOISE LEVEL

The figures quoted are emission levels and are not necessarily safe working levels. Whilst there is a correlation between the emission and exposure levels, this cannot be used reliably to determine whether or not further precautions are required. Factors that influence the actual level of exposure of work-force include the characteristics of the work room, the other sources of noise, etc. i.e. the number of machines and other adjacent processes, and the length of time for which an operator is exposed to the noise. Also the permissible exposure level can vary from country. This information, however, will enable the use of the machine to make a better evaluation of the hazard and risk.



WARNING

- For safety, read owner's manual carefully before operating this machine, according to the rules of operation and maintenance.
- Il convient de lire attentivement ce manuel avant la première utilisation de la machine.
- Lea este manual atentamente antes de utilizar este equipo.
- Bitte lesen Sie diese Bedienungsanleitung sorgfältig durch, bevor Sie die Maschine in Betrieb nehmen.
- Les denne håndboken nøye før du tar maskinen i bruk.
- Διαβάστε προσεκτικά αυτό το βιβλίο πριν λειτουργήσετε τη μηχανή.
- Lees deze handleiding aandachtig door voordat u deze machine gaat gebruiken.
- Leggere attentamente questo manuale prima di utilizzare questa macchina.
- 为保证安全，使用前请务必仔细阅读使用说明书并按规定操作保养。

400002