

Robex

260LC-9A

With Tier 4 Interim Engine installed

HYUNDAI HEAVY INDUSTRIES

MOVING YOU FURTHER



*Photo may include optional equipment.

 **HYUNDAI**
CONSTRUCTION EQUIPMENT AMERICAS, INC.

PRIDE AT WORK

Hyundai Heavy Industries strives to build state-of-the-art earthmoving equipment to give every operator maximum performance, more precision, versatile machine preferences, and proven quality.

Take pride in your work with Hyundai!



Robex 260LC-9A

Machine Walk-Around

Engine Technology

Proven, reliable, fuel efficient, low emission and low noise
Cummins Tier 4 interim & EU stage III B engine

Hydraulic System Improvements

New patented hydraulic control for improved controllability / Improved control valve design for added efficiency and smoother operation / New auto boom and swing priority system for optimum speed / New auto power boost feature for additional power when needed / Improved arm-in and boom-down flow regeneration system for added speed and efficiency

Pump Compartment

Industry-leading, powerful, reliable Kawasaki designed, variable volume in-line axial piston pumps
New compact solenoid block equipped with 4 solenoid valves, 1 EPPR valve, 1 check valve accumulator and pilot filter - controls 2 speed travel, power boost, boom priority, safety lock, arm regeneration

Enhanced Operator Cab

Improved Visibility

Enlarged cab with improved visibility / See-through upper skylight for visibility and ventilation
Larger right-side glass, now one piece, for better right visibility
Safety glass windows on all sides - less expensive than (polycarbonate) and won't scratch or fade
Closeable sunshade for operator convenience / Reduced front window seam for improved operator view

Improved Cab Construction

New steel tube construction for added operator safety, protection and durability
New window open/close mechanism designed with cable and spring lift assist and single latch release

Improved Suspension Seat / Console Assembly

Ergonomic joysticks with auxiliary control buttons for attachment use. Now with new sleek styling
Heated suspension (standard) or optional air ride suspension with heat
New joystick consoles - now adjustable in height by pushing the button
Integrated seat with consoles - reduce the operator fatigue

Advanced 7" Color Cluster with Touch Screen

New Color LCD Display with easy to read digital gauges for hydraulic oil temperature, water temperature, and fuel. Simplified design makes adjustment and diagnostics easier. Also, new enhanced features such as rear-view camera are integrated into monitor.

3 power modes : (P) Power, (S) Standard, (E) Economy, 2 work modes : Dig & Attachment, (U) User mode for operator preference

Enhanced self-diagnostic features with GPS download capability

One pump flow or two pump flow for optional attachment is now selectable through the cluster / New anti-theft system with password capability

Boom speed and arm regeneration are selectable through the monitor.

Auto power boost is now available - selectable (on/off) through the monitor.

Powerful air conditioning and heat with auto climate control

RMS (Remote Management System) works through GPS/satellite technology to ultimately provide better customer service and support.

Undercarriage

Sealed track chain (urethane seals) / Standard track rail guard / Comfortable bolt-on steps

Large upper roller cut-outs for debris clean-out / Tapered side frames for debris clean-out / Grease-type track tensioner

*Photo may include optional equipment.

PRECISION

Innovative hydraulic system technologies make the 9A series excavator fast, smooth and easy to control.



*Photo may include optional equipment.

Computer Aided Power

The engine horsepower and hydraulic horsepower together in unison through the advanced CAPO(Computer Aided Power Optimization) system, flow for the job at hand. Operator can set their own preferences for boom or swing priority, power mode selection and optional work tools at the touch of a button.

The CAPO system also provides complete self diagnostic features and digital gauges for important information like hydraulic oil temperature, water temperatures and fuel level. This system interfaces with multiple sensors placed throughout the hydraulic system as well as the electronically controlled engine to provide the optimum level of engine power and hydraulic flow.

Power Mode

P (Power Max) mode maximizes machine speed and power for mass production.

S (Standard) mode provides a reduced, fixed rpm for optimum performance and improved fuel economy. For maximum fuel savings and improved control, E (Economy) mode provides precise flow and engine power based on load demand. Three unique power modes provide the operator with custom power, speed and fuel economy.

Work Mode

The work mode allows the operator to select single flow attachments like a hydraulic breaker or bi-directional flow attachments like a crusher. Flow settings unique to each attachment can be programmed from within the cluster.

User Mode

Some jobs require more precise machine settings. Using the versatile U (User) mode, the operator can customize engine speed, pump output, idle speed and other machine settings for the job at hand.

Improved Hydraulic System



To achieve optimum precision, Hyundai redesigned the hydraulic system to provide the operator with super fine touch and improved controllability. Improved pump flow control reduces flow when controls are not being used to minimize fuel consumption.

Improved spool valves in the control valve are engineered to provide more precise flow to each function with less effort.

Improved hydraulic valves, precision-designed variable volume piston pumps, fine-touch pilot controls, and enhanced travel functions make any operator running a 9A series look like a smooth operator. Newly improved features

include arm-in and boom-down flow regeneration, improved control valve technology and innovative auto boom and swing priority for optimal performance in any application.



Auto Boom-swing Priority

This smart function automatically and continuously looks the ideal hydraulic flow balance for the boom and swing motions of the machine. The advanced CAPO system monitors the hydraulic system and adjusts its settings to maximize performance and productivity.

PERFORMANCE

9A series is designed for maximum performance to keep the operator working productively.



*Photo may include optional equipment.

Track Rail Guard & Adjusters

Durable track rail guards keep track links in place. Track adjustment is made easy with standard grease cylinder track adjusters and shock absorbing springs.

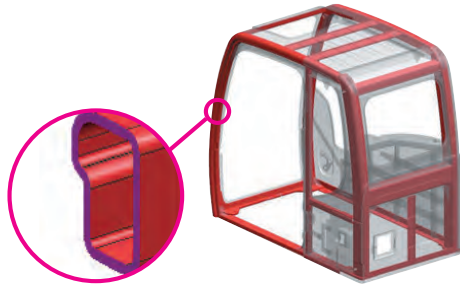

Structure Strength

The 9A series cabin structure has been fitted with stronger but slimmer tubing for more safety and improved visibility. Low-stress, high strength steel is integrally welded to form a stronger, more durable upper and lower frame. Structural integrity was tested by way of FEM (Finite Elements Method) analysis and long-term durability tests. The optional ROPS(Roll Over Protective Structure) cab can be equipped to enhance operator safety.

Cummins QSB6.7 Engine

QSB6.7 engine above 174 hp (130 kW) meet Tier 4 Interim/Stage III B emissions regulation with the combination of a proven cooled-EGR system, High Pressure Common Rail (HPCR) fuel system, Cummins Diesel Oxidation Catalyst and Particulate Filter. The QSB6.7 is also complemented by patented VGT™ Turbocharger, which continuously varies the airflow boost to precisely match engine rpm and load demands for optimal performance. This engine features the Cummins Direct Flow™ air filter, which has a smaller profile than radial filters. The result is an engine that fits into existing equipment, delivers better performance with faster cycle times and better fuel economy than the previous model.

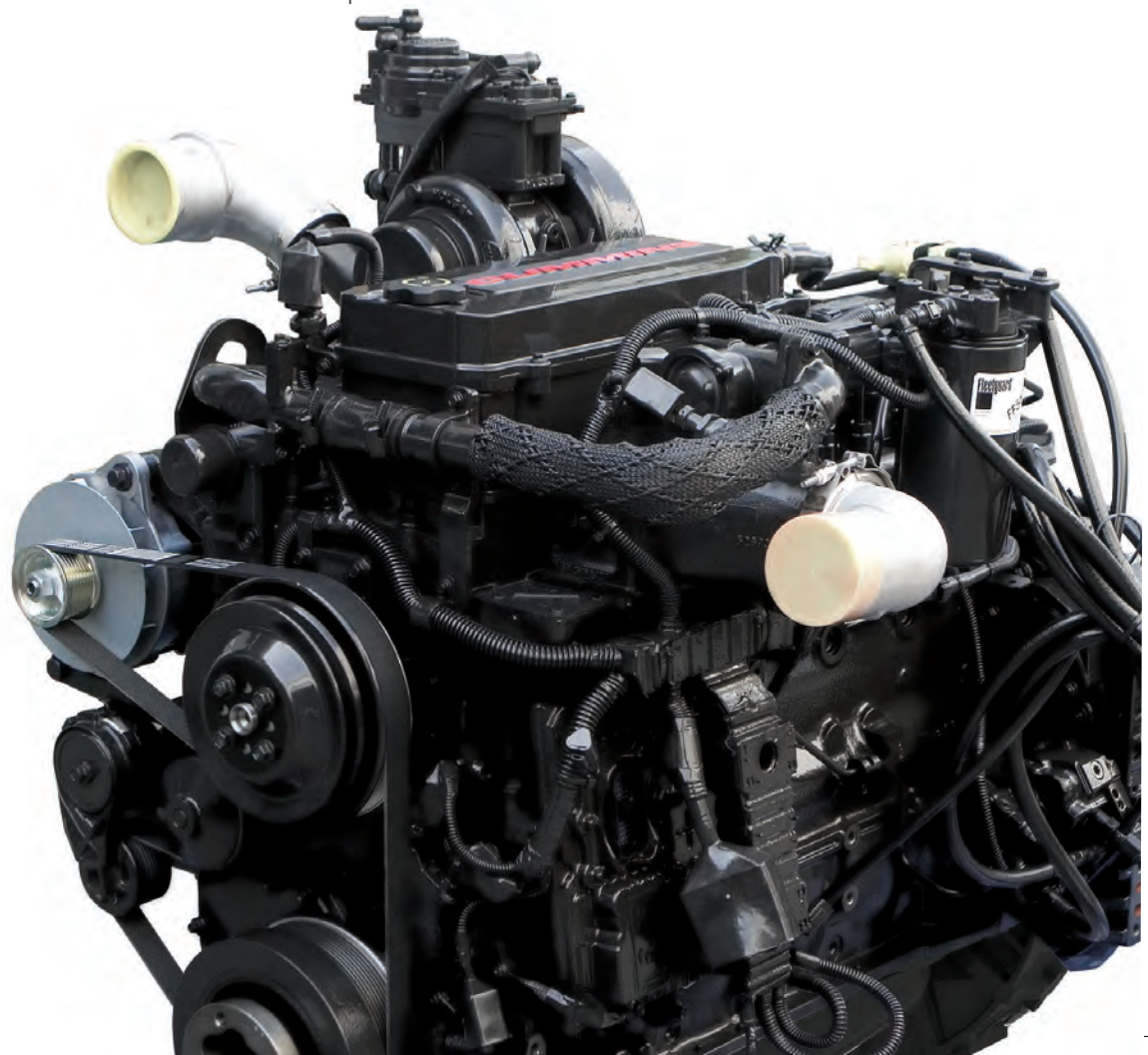

PREFERENCE

Operating a 9A series is unique to every operator. Operators can fully customize their work environment and operating preferences to fit their individual needs.



*Photo may include optional equipment.



Wide Cabin with Excellent Visibility

The newly designed cabin was conceived for more space, a wider field of view and operator comfort. Special attention was given to a clear, open and convenient interior with plenty of visibility on the machine surroundings and the job at hand. This well balanced combination of precision aspects put the operator in the perfect position to work safely and securely.

Operator Comfort

In 9A series cabin you can easily adjust the seat, console and armrest settings to best suit your comfort level. The seat integrated with console absorb console vibration by seat suspension and reduce operator's fatigue. New joystick consoles are adjustable in height by pushing the button. Other preference settings that add to overall operator comfort include the fully automatic high capacity airconditioning system, transparent polycarbonate glass sun roof, large and easy to control sun visor, and the Radio / USB player.



Reduced Stress

Work is stressful enough. Your work environment should be stress free. Hyundai's 9A series provides improved cab amenities, additional space and a comfortable seat to minimize stress to the operator. A powerful climate control system provides the operator with optimum air temperature. An advanced audio system with USB player, AM/FM stereo and MP3 capabilities, plus remotely located controls is perfect for listening to music favorites.

Operators can even talk on the phone with the hands-free cell phone feature. Also, the newly designed optional remote control offers mobile bluetooth-handsfree and radio cable-handsfree function.



Smart Key System (Option)

9A series excavators provide smart key system as an option. This allows the operator to start the engine by the push of a starter button without inserting a key in the ignition.



Operator - Friendly Cluster

The advanced new cluster with 7 inch wide color LCD with touch screen and toggle switch allows the operator to select his personal machine preferences. Power and work mode selection, self diagnostics, optional rear-view camera, maintenance check lists, start-up machine security, and video functions were integrated into the cluster to make the machine more versatile and the operator more productive.

The newly applied FM transmitter application transmits signal to USB & Radio player with the same frequency as cluster. The player outputs the audio through the internal speaker in the cab. The video & firmware updates are possible with USB host support and an adjustable cluster hinge bracket improves cluster visibility.

Monitor Tilt Range



Horizontal
Total : 15°



Vertical
Total : 30°



PROFITABILITY

9A series is designed to maximize profitability through improved efficiencies, enhanced service features and longer life components.



*Photo may include optional equipment.

Fuel Efficiency

9A series excavators are engineered to be extremely fuel efficient. New innovations like the variable speed fan clutch, two-stage auto decel system and the new economy mode help to conserve fuel and reduce the impact on the environment.



Hi-mate (Remote Management System)

Hi-mate, Hyundai's proprietary remote management system, provides operators and dealer service personnel access to vital service and diagnostic information on the machine from any computer with internet access. Users can pinpoint machine location using digital mapping and set machine work boundaries, reducing the need for multiple service calls. Hi-mate saves time and money for the owner and dealer by promoting preventative maintenance and reducing machine downtime.

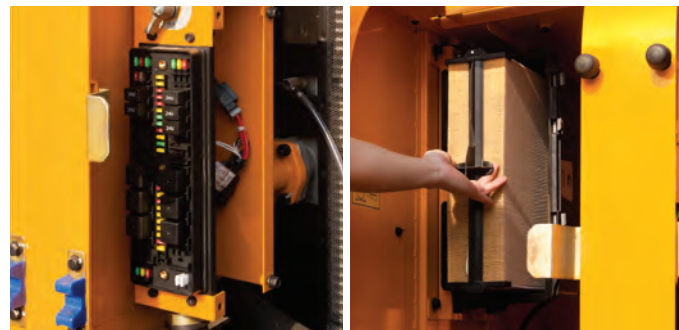
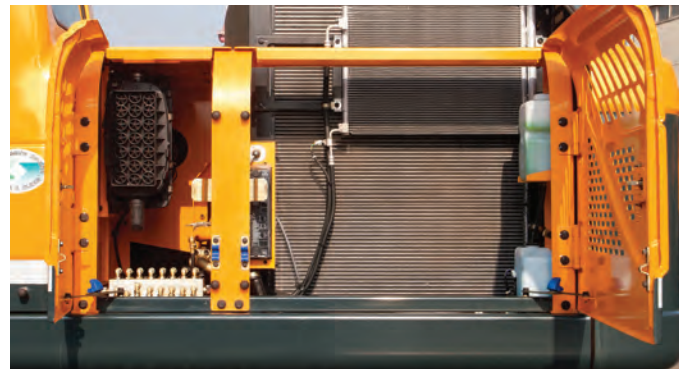

Easy Access

Ground-line access to filters, lube fittings, fuses, machine computer components and wide open compartments makes service more convenient on the 9A series.



Long-Life Components

9A series excavators were designed with bushings designed for long-life lube intervals (250 hrs) & polymer shims (wear resistant, noise reducing), long-life hydraulic filters (1,000hrs), long-life hydraulic oil (5,000hrs), more efficient cooling systems and integrated preheating systems which extend service intervals, minimize operating costs and reduce machine down time.

Specifications

ENGINE

MODEL		Cummins QSB6.7	
Type		Water-cooled, 4-cycle Diesel, 6-cylinder in-line, Direct injection, Turbocharged, Charge air cooled, Low emission	
Rated flywheel horse power	SAE	J1995(gross)	188 HP (140 kW)/ 1,900 rpm
		J1349 (net)	178 HP (132 kW)/ 1,900 rpm
	DIN	6271/1 (gross)	191 PS (140 kW)/ 1,900 rpm
		6271/1 (net)	180 PS (132 kW)/ 1,900 rpm
Max. torque		82.5 kgf-m(597 lbf-ft)/ 1,500 rpm	
Bore X stroke		107 x 124 mm (4.21" x 4.88")	
Piston displacement		6,700cc (408 in ³)	
Batteries		2 X 12V X 100AH	
Starting motor		24V, 4.8kW	
Alternator		24V, 95Amp	

HYDRAULIC SYSTEM

MAIN PUMP	
Type	Variable displacement tandem-axial piston pumps
Max. flow	2 X 222 L/min (58.6 US gpm / 48.8 UK gpm)
Sub-pump for pilot circuit	Gear pump

Cross-sensing and fuel saving pump system

HYDRAULIC MOTORS	
Travel	Two-speed axial pistons motor with brake valve and parking brake
Swing	Axial piston motor with automatic brake

RELIEF VALVE SETTING	
Implement circuits	350 kgf/cm ² (4,978 psi)
Travel	350 kgf/cm ² (4,978 psi)
Power boost (boom, arm, bucket)	380 kgf/cm ² (5,404 psi)
Swing circuit	300 kgf/cm ² (4,409 psi)
Pilot circuit	40 kgf/cm ² (568 psi)
Service valve	Installed

HYDRAULIC CYLINDERS	
No. of cylinder	Boom: 2-135 X1,345 mm (5.3" X 52.9") Arm: 1-145 X 1,620 mm (5.7" X 63.8") Bucket: 1-130 X 1,185 mm (5.1" X 46.7")
bore X stroke	

DRIVES & BRAKES

Drive method	Fully hydrostatic type
Drive motor	Axial piston motor, in-shoe design
Reduction system	Planetary reduction gear
Max. drawbar pull	21,600 kgf (47,600 lbf)
Max. travel speed (high / low)	5.6 km/hr (3.5 mph) / 3.3 km/hr (2.0 mph)
Gradeability	35° (70 %)
Parking brake	Multi wet disc

CONTROL

Pilot pressure operated joysticks and pedals with detachable lever provide almost effortless and fatigueless operation.

Pilot control	Two joysticks with one safety lever (LH): Swing and arm, (RH): Boom and bucket (ISO)
Traveling and steering	Two levers with pedals
Engine throttle	Electric, Dial type

SWING SYSTEM

Swing motor	Fixed displacement axial pistons motor
Swing reduction	Planetary gear reduction
Swing bearing lubrication	Grease-bathed
Swing brake	Multi wet disc
Swing speed	11.6 rpm

COOLANT & LUBRICANT CAPACITY

	liter	US gal	UK gal
Re-filling			
Fuel tank	400	105.7	88.0
Engine coolant	40	10.6	8.8
Engine oil	23.1	6.1	5.1
Swing device	6	1.6	1.3
Final drive (each)	6	1.6	1.3
Hydraulic system (including tank)	285	75.3	62.7
Hydraulic tank	165	43.6	36.3

UNDERCARRIAGE

The X-leg type center frame is integrally welded with reinforced box-section track frames. The undercarriage includes lubricated rollers, idlers, track adjusters with shock absorbing springs and sprockets, and a track chain with double or triple grouser shoes.

Center frame	X - leg type
Track frame	Pentagonal box type
No. of shoes on each side	51
No. of carrier rollers on each side	2
No. of track rollers on each side	9
No. of rail guards on each side	2

OPERATING WEIGHT (APPROXIMATE)

Operating weight, including 5,850mm (19' 2") boom, 3,050mm (10' 0") arm, SAE heaped 1.08m³ (1.41 yd³) bucket, lubricant, coolant, full fuel tank, full hydraulic tank, and all standard equipments.

MAJOR COMPONENT WEIGHT	
Upperstructure	5,520 kg (12,170 lb)
Boom (with arm cylinder)	2,460 kg (5,420 lb)
Arm (with bucket cylinder)	1,540 kg (3,400 lb)

OPERATING WEIGHT				
Shoes		Operating weight		Ground pressure
Type	Width mm (in)	kg (lb)		kgf/cm ² (psi)
Triple grouser	600 mm (24")	R260LC-9A	25,200(55,560)	0.51(7.25)
		R260LC-9A H/W	27,450(60,520)	0.53(7.54)
	700 mm (28")	R260LC-9A	25,500(56,220)	0.44(6.26)
		R260LC-9A H/W	28,020(61,770)	0.46(6.54)
	800 mm (32")	R260LC-9A	25,800(56,880)	0.39(5.55)
		R260LC-9A H/W	28,400(62,610)	0.41(5.83)
900 mm (36")	R260LC-9A	26,100(57,540)	0.35(4.98)	
	Double grouser	700 mm (28")	R260LC-9A H/W 28,620(63,100)	0.47(6.68)

BUCKETS

All buckets are welded with high-strength steel.



SAE
heaped
m³ (yd³)

0.60 (0.78)
0.79 (1.03)



1.03 (1.35)



1.08 (1.41)
1.27 (1.66)
1.50 (1.96)



1.07(1.40) 1.27(1.66)
 1.15(1.50) 1.46(1.91)



1.16 (1.52)

Capacity m ³ (yd ³)		Width mm (in)		Weight kg (lb)	Recommendation mm (ft-in)			
SAE heaped	CECE heaped	Without side cutters	With side cutters		5,850 (19' 2") Boom			
					2,100 (6' 11") Arm	2,500 (8' 2") Arm	3,050 (10' 0") Arm	3,600 (11' 10") Arm
0.60 (0.78)	0.55 (0.72)	760 (29.9)	880 (34.6)	720 (1,590)	●	●	●	●
0.79 (1.03)	0.70 (0.92)	890 (35.0)	1,010 (39.8)	790 (1,740)	●	●	●	●
1.03 (1.35)	0.90 (1.18)	1090 (42.9)	1,210 (47.6)	890 (1,960)	●	●	●	<input type="checkbox"/>
1.08 (1.41)	0.95 (1.24)	1,130 (44.5)	1,250 (49.2)	910 (2,010)	●	●	●	<input type="checkbox"/>
1.27 (1.66)	1.10 (1.44)	1,290 (50.8)	1,410 (55.5)	1,010 (2,230)	●	<input type="checkbox"/>	<input type="checkbox"/>	▲
1.50 (1.96)	1.30 (1.70)	1,490 (58.7)	1,610 (63.4)	1,080 (2,380)	●	<input type="checkbox"/>	▲	-
<input type="checkbox"/> 1.07 (1.40)	0.95 (1.24)	1,150 (45.3)	-	1,120 (2,470)	●	●	<input type="checkbox"/>	▲
<input type="checkbox"/> 1.15 (1.50)	1.00 (1.31)	1,210 (47.6)	-	1,160 (2,560)	●	●	<input type="checkbox"/>	▲
<input type="checkbox"/> 1.27 (1.66)	1.10 (1.44)	1,310 (51.6)	-	1,240 (2,730)	●	<input type="checkbox"/>	▲	-
<input type="checkbox"/> 1.46 (1.91)	1.28 (1.67)	1,460 (57.5)	-	1,320 (2,910)	<input type="checkbox"/>	▲	▲	-
<input type="checkbox"/> 1.16 (1.52)	1.00 (1.31)	1,340 (52.8)	-	1,280 (2,820)	●	<input type="checkbox"/>	▲	-

- Heavy duty bucket
- Rock-Heavy duty bucket

- : Applicable for materials with density of 2,000 kg /m³ (3,370 lb/ yd³) or less
- : Applicable for materials with density of 1,600 kg /m³ (2,700 lb/ yd³) or less
- ▲ : Applicable for materials with density of 1,100 kg /m³ (1,850 lb/ yd³) or less

ATTACHMENT

Booms and arms are welded with a low-stress, full-box section design. 5.85m(19' 2") Boom and 2.1m(6' 11"), 2.5m(8' 2"), 3.05m(10' 0") & 3.6m(11' 10") Arms are available.

DIGGING FORCE

Boom	Length	mm(ft-in)	5,850 (19' 2")				Remark
	Weight	kg(lb)	2,460(5,420)				
Arm	Length	mm(ft-in)	2,100 (6' 11")	2,500 (8' 2")	3,050 (10' 0")	3,600 (11' 10")	Power Boost
	Weight	kg(lb)	1,420 (3,130)	1,450 (3,200)	1,540 (3,400)	1,600 (3,530)	
Bucket digging force	SAE	kN	156.9 [170.4]	156.9 [170.4]	156.9 [170.4]	156.9 [170.4]	[]: Power Boost
		kgf	16000 [17370]	16000 [17370]	16000 [17370]	16000 [17370]	
		lbf	35270 [38290]	35270 [38290]	35270 [38290]	35270 [38290]	
	ISO	kN	178.5 [193.8]	178.5 [193.8]	178.5 [193.8]	178.5 [193.8]	
		kgf	18200 [19760]	18200 [19760]	18200 [19760]	18200 [19760]	
		lbf	40120 [43560]	40120 [43560]	40120 [43560]	40120 [43560]	
Arm crowd force	SAE	kN	134.4 [145.9]	130.4 [141.6]	114.7 [124.6]	104.0 [112.9]	[]: Power Boost
		kgf	13700 [14870]	13300 [14440]	11700 [12700]	10600 [11510]	
		lbf	30200 [32790]	29320 [31830]	25790 [28000]	23370 [25370]	
	ISO	kN	139.3 [151.2]	134.4 [145.9]	118.7 [128.8]	107.9 [117.1]	
		kgf	14200 [15420]	13700 [14870]	12100 [13140]	11000 [11940]	
		lbf	31310 [33990]	30200 [32790]	26680 [28970]	24250 [26330]	

Note: Boom weight includes arm cylinder, piping, and pin
Arm weight includes bucket cylinder, linkage, and pin

Dimensions & Working Range

R260LC-9A / R260NLC-9A DIMENSIONS

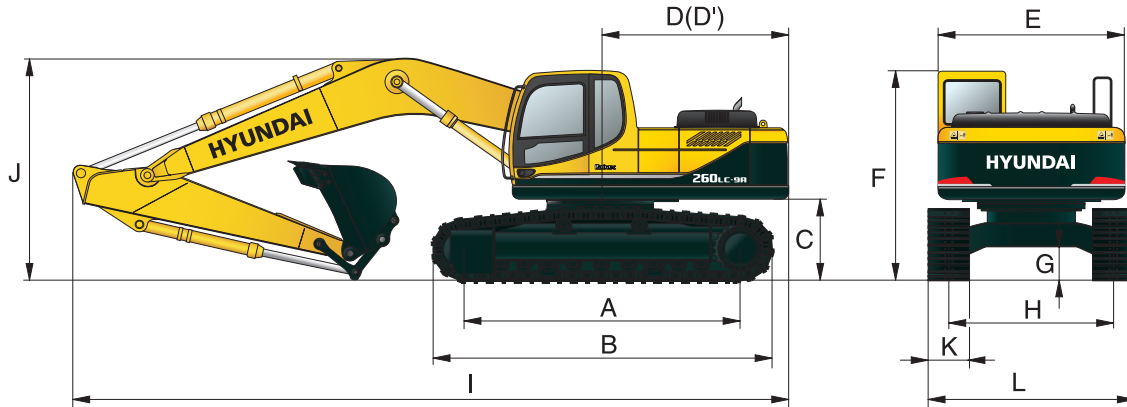

Unit : mm (ft · in)

A Tumbler distance	R260LC-9A	3,830 (12' 7")	5,850 (19' 2")			
	R260NLC-9A	3,830 (12' 7")				
B Overall length of crawler		4,640 (15' 3")				
C Ground clearance of counterweight		1,115 (3' 8")				
D Tail swing radius		2,975 (9' 9")				
D' Rear-end length		2,870 (9' 5")				
E Overall width of upperstructure		2,840 (9' 4")				
F Overall height of cab		2,990 (9' 10")				
G Min. ground clearance		480 (1' 7")				
H Track gauge	R260LC-9A	2,580 (8' 6")				
	R260NLC-9A	2,380 (7' 10")				
Boom length			5,850 (19' 2")			
Arm length			2,100 (6' 11")	2,500 (8' 2")	3,050 (10' 0")	3,600 (11' 10")
I Overall length			10,050 (32' 12")	10,000 (32' 10")	9,920 (32' 7")	9,910 (32' 6")
J Overall height of boom			3,530 (11' 7")	3,590 (11' 9")	3,220 (10' 7")	3,590 (11' 9")
K Track shoe width			600 (24")	700 (28")	800 (32")	900 (36")
L Overall width	R260LC-9A		3,180 (10' 5")	3,280 (10' 9")	3,380 (11' 1")	3,480 (11' 5")
	R260NLC-9A		2,980 (9' 9")	-	-	-

R260LC-9A / R260NLC-9A WORKING RANGE

Unit : mm (ft · in)

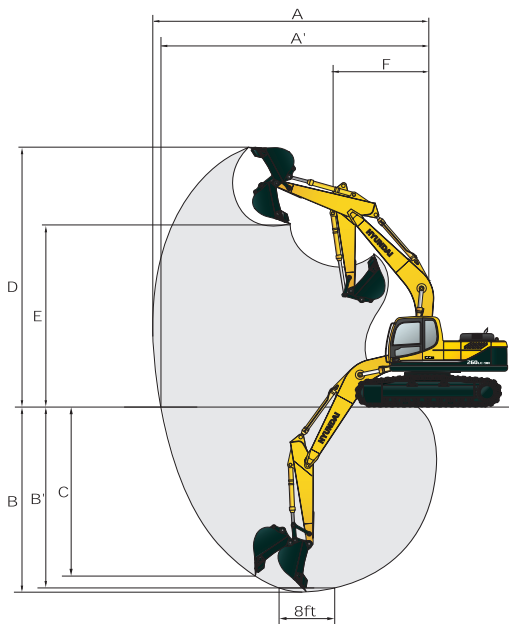

Boom length		5,850 (19' 2")			
Arm length		2,100 (6' 11")	2,500 (8' 2")	3,050 (10' 0")	3,600 (11' 10")
A Max. digging reach		9,550 (31' 4")	9,870 (32' 5")	10,360 (33' 12")	10,870 (35' 8")
A' Max. digging reach on ground		9,360 (30' 9")	9,680 (31' 9")	10,190 (33' 5")	10,700 (35' 1")
B Max. digging depth		6,050 (19' 10")	6,450 (21' 2")	7,000 (22' 12")	7,550 (24' 9")
B' Max. digging depth (8' level)		5,840 (19' 2")	6,260 (20' 6")	6,830 (22' 5")	7,400 (24' 3")
C Max. vertical wall digging depth		5,480 (17' 12")	5,640 (18' 6")	6,150 (20' 2")	6,830 (22' 5")
D Max. digging height		9,450 (31' 0")	9,460 (31' 0")	9,670 (31' 9")	9,920 (32' 7")
E Max. dumping height		6,360 (20' 10")	6,420 (21' 1")	6,630 (21' 9")	6,860 (22' 6")
F Min. swing radius		4,420 (14' 6")	4,200 (13' 9")	3,980 (13' 1")	3,900 (12' 10")

Dimensions & Working Range

R260LC-9A HIGH WALKER DIMENSIONS

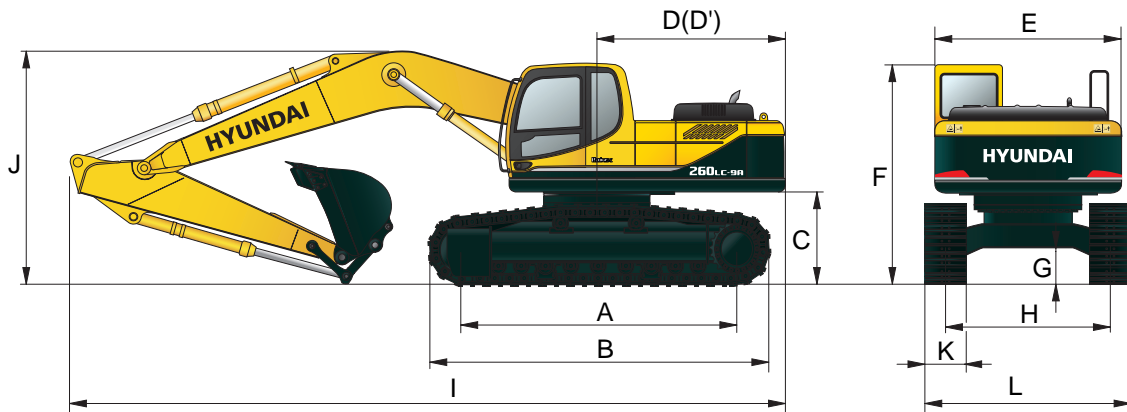

Unit : mm (ft · in)

A Tumbler distance	4,030 (13' 3")	Boom length	5,850 (19' 2")				
B Overall length of crawler	4,940 (16' 2")	Arm length	2,100 (6' 11")	2,500 (8' 2")	3,050 (10' 0")	3,600 (11' 10")	
C Ground clearance of counterweight	1,470 (4' 10")	I Overall length	10,060 (33' 0")	9,970 (32' 9")	9,760 (32' 0")	9,930 (32' 7")	
D Tail swing radius	2,975 (9' 9")	J Overall height of boom	3,610 (11' 10")	3,750 (12' 4")	3,240 (10' 8")	3,620 (11' 11")	
D' Rear-end length	2,870 (9' 5")	K Track shoe width	Type	Triple grouser			Double grouser
E Overall width of upperstructure	2,840 (9' 4")			Width	600 (24")	700 (28")	800 (32")
F Overall height of cab	3,345 (10' 12")	L Overall width	3,390 (11' 1")	3,490 (11' 5")	3,590 (11' 9")	3,490 (11' 5")	
G Min. ground clearance	765 (2' 6")						
H Track gauge	2,790 (9' 2")						

R260LC-9A HIGH WALKER WORKING RANGE

Unit : mm (ft · in)

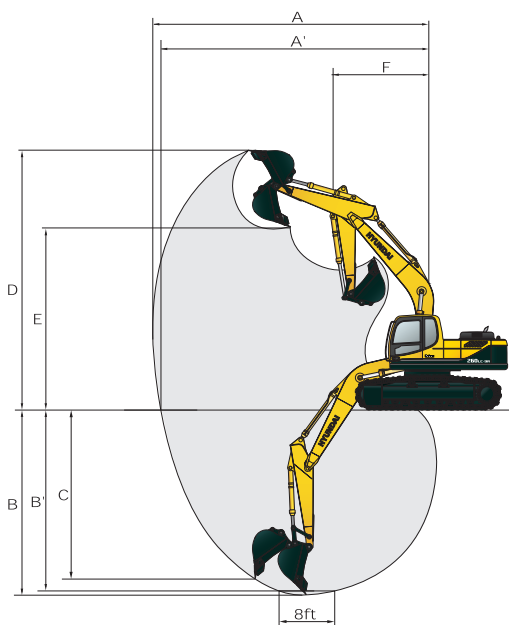











Boom length	5,850 (19' 2")			
Arm length	2,100 (6' 11")	2,500 (8' 2")	3,050 (10' 0")	3,600 (11' 10")
A Max. digging reach	9,550 (31' 4")	9,870 (32' 5")	10,360 (33' 12")	10,870 (35' 8")
A' Max. digging reach on ground	9,280 (30' 5")	9,160 (30' 1")	10,110 (33' 2")	10,360 (33' 12")
B Max. digging depth	5,680 (18' 8")	6,080 (19' 11")	6,630 (21' 9")	7,180 (23' 7")
B' Max. digging depth (8° level)	5,470 (17' 11")	5,890 (19' 4")	6,460 (21' 2")	7,030 (23' 1")
C Max. vertical wall digging depth	5,120 (16' 10")	5,300 (17' 5")	5,790 (18' 12")	6,470 (21' 3")
D Max. digging height	9,820 (32' 3")	9,840 (32' 3")	10,040 (32' 11")	10,280 (33' 9")
E Max. dumping height	6,730 (22' 1")	6,790 (22' 3")	7,000 (22' 12")	7,220 (23' 8")
F Min. swing radius	4,140 (13' 7")	4,030 (13' 3")	3,940 (12' 11")	3,900 (12' 10")

Lifting Capacity











R260LC-9A

 Rating over-front  Rating over-side or 360 degree











Boom : 5.85m (19' 2") / Arm : 2.10 m (6' 11") / Bucket : 1.08 m³ (1.41 yd³) SAE heaped / Shoe : 600mm (24") triple grouser

Load point height m(ft)	Load radius								At max. reach			
	3.0 m (10 ft)		4.5 m (15 ft)		6.0 m (20 ft)		7.5 m (25 ft)		Capacity		Reach m (ft)	
												
6.0 m (20 ft)	kg					*5790	*5790			5220	3200	8.32 (27.3)
	lb					*12760	*12760			11510	7050	
4.5 m (15 ft)	kg		*7810	*7810	*6510	5570	*6000	3690		4520	2710	8.91 (29.2)
	lb		*17220	*17220	*14350	12280	*13230	8140		9960	5970	
3.0 m (10 ft)	kg		*10260	8200	*7600	5190	5900	3550		4210	2480	9.17 (30.1)
	lb		*22620	18080	*16760	11440	13010	7830		9280	5470	
1.5 m (5 ft)	kg		*12300	7520	8250	4850	5720	3380		4170	2430	9.14 (30.0)
	lb		*27120	16580	18190	10690	12610	7450		9190	5360	
Ground	kg		13110	7250	8010	4640	5600	3270		4410	2580	8.80 (28.9)
	lb		28900	15980	17660	10230	12350	7210		9720	5690	
-1.5 m (-5 ft)	kg	*15460	15160	13090	7230	7940	4580			5060	2990	8.13 (26.7)
	lb	*34080	33420	28860	15940	17500	10100			11160	6590	
-3.0 m (-10 ft)	kg	*17100	15470	*12090	7390	8050	4680			*6290	3980	6.98 (22.9)
	lb	*37700	34110	*26650	16290	17750	10320			*13870	8770	
-4.5 m (-15 ft)	kg	*13360	*13360	*9460	7790							
	lb	*29450	*29450	*20860	17170							

Boom : 5.85m (19' 2") / Arm : 2.50 m (8' 2") / Bucket : 1.08 m³ (1.41 yd³) SAE heaped / Shoe : 600mm (24") triple grouser

Load point height m(ft)	Load radius								At max. reach				
	1.5 m (5 ft)		3.0 m (10 ft)		4.5 m (15 ft)		6.0 m (20 ft)		7.5 m (25 ft)		Capacity		Reach m (ft)
													
6.0 m (20 ft)	kg										4900	3000	8.67 (28.4)
	lb										10800	6610	
4.5 m (15 ft)	kg						*6070	5670	*5630	3770	4280	2550	9.23 (30.3)
	lb						*13380	12500	*12410	8310	9440	5620	
3.0 m (10 ft)	kg				*9550	8410	*7210	5280	5950	3590	3990	2340	9.48 (31.1)
	lb				*21050	18540	*15900	11640	13120	7910	8800	5160	
1.5 m (5 ft)	kg				*11790	7650	8310	4910	5750	3410	3950	2290	9.45 (31.0)
	lb				*25990	16870	18320	10820	12680	7520	8710	5050	
Ground	kg				*12990	7280	8030	4660	5600	3270	4150	2410	9.13 (30.0)
	lb				*28640	16050	17700	10270	12350	7210	9150	5310	
-1.5 m (-5 ft)	kg		*15100	14960	13050	7190	7910	4560	5550	3220	4690	2750	8.49 (27.9)
	lb		*33290	32980	28770	15850	17440	10050	12240	7100	10340	6060	
-3.0 m (-10 ft)	kg	*16360	*16360	*18120	15250	*12470	7300	7970	4610		5940	3550	7.41 (24.3)
	lb	*36070	*36070	*39950	33620	*27490	16090	17570	10160		13100	7830	
-4.5 m (-15 ft)	kg			*14860	*14860	*10430	7620						
	lb			*32760	*32760	*22990	16800						

Boom : 5.85m (19' 2") / Arm : 3.05 m (10' 0") / Bucket : 1.08 m³ (1.41 yd³) SAE heaped / Shoe : 600mm (24") triple grouser

Load point height m(ft)	Load radius								At max. reach					
	1.5 m (5 ft)		3.0 m (10 ft)		4.5 m (15 ft)		6.0 m (20 ft)		7.5 m (25 ft)		Capacity		Reach m (ft)	
														
6.0 m (20 ft)	kg								*3700	*3700	4400	2660	9.22 (30.2)	
	lb								*8160	*8160	9700	5860		
4.5 m (15 ft)	kg						*5350	*5350	*5060	3830	3880	2280	9.74 (32.0)	
	lb						*11790	*11790	*11160	8440	8550	5030		
3.0 m (10 ft)	kg		*13640	*13640	*8400	*8400	*6540	5360	*5660	3620	3630	2090	9.98 (32.7)	
	lb		*30070	*30070	*18520	*18520	*14420	11820	*12480	7980	8000	4610		
1.5 m (5 ft)	kg		*9450	*9450	*10870	7800	*7820	4950	5750	3400	3580	2040	9.95 (32.6)	
	lb		*20830	*20830	*23960	17200	*17240	10910	12680	7500	7890	4500		
Ground	kg		*10570	*10570	*12490	7280	8010	4640	5560	3230	3730	2130	9.65 (31.7)	
	lb		*23300	*23300	*27540	16050	17660	10230	12260	7120	8220	4700		
-1.5 m (-5 ft)	kg	*9940	*9940	*13870	*13870	12930	7090	7830	4480	5460	3140	4150	2390	9.05 (29.7)
	lb	*21910	*21910	*30580	*30580	28510	15630	17260	9880	12040	6920	9150	5270	
-3.0 m (-10 ft)	kg	*13540	*13540	*18430	14860	*12780	7110	7820	4470			5080	2980	8.06 (26.4)
	lb	*29850	*29850	*40630	32760	*28180	15670	17240	9850			11200	6570	
-4.5 m (-15 ft)	kg	*17830	*17830	*16580	15340	*11360	7340	8020	4640			*5940	4480	6.48 (21.3)
	lb	*39310	*39310	*36550	33820	*25040	16180	17680	10230			*13100	9880	

1. Lifting capacity is based on SAE J1097, ISO 10567.

2. Lifting capacity of the Robex Series does not exceed 75% of the tipping load with the machine on firm, level ground or 87% of full hydraulic capacity.

3. The load point is a hook located on the back of the bucket.













4. (*) indicates the load limited by hydraulic capacity.

Lifting Capacity

R260LC-9A











 Rating over-front  Rating over-side or 360 degree

Boom : 5.85m (19' 2") / Arm : 3.60 m (11' 10") / Bucket : 1.08 m³ (1.41 yd³) SAE heaped / Shoe : 600mm (24") triple grouser











Load point height m(ft)		Load radius										At max. reach						
		1.5 m (5 ft)		3.0 m (10 ft)		4.5 m (15 ft)		6.0 m (20 ft)		7.5 m (25 ft)		9.0 m (30 ft)		Capacity	Reach			
															m (ft)			
6.0 m	kg									*3930	*3930			3960	2360	9.77		
(20 ft)	lb									*8660	*8660			8730	5200	(32.1)		
4.5 m	kg									*4530	3890	*2500	*2500	3530	2040	10.27		
(15 ft)	lb									*9990	8580	*5510	*5510	7780	4500	(33.7)		
3.0 m	kg									*5890	5490	*5190	3670	*3590	2550	3310	1870	10.49
(10 ft)	lb									*12990	12100	*11440	8090	*7910	5620	7300	4120	(34.4)
1.5 m	kg			*12610	*12610	*9960	8040	*7260	5040	5790	3430	4210	2430	3260	1820	10.46		
(5 ft)	lb			*27800	*27800	*21960	17730	*16010	11110	12760	7560	9280	5360	7190	4010	(34.3)		
Ground	kg			*11020	*11020	*11930	7390	8070	4680	5570	3230	4090	2320	3380	1890	10.18		
Line	lb			*24290	*24290	*26300	16290	17790	10320	12280	7120	9020	5110	7450	4170	(33.4)		
-1.5 m	kg	*9010	*9010	*13200	*13200	*12900	7090	7830	4470	5430	3100			3710	2100	9.62		
(-5 ft)	lb	*19860	*19860	*29100	*29100	*28440	15630	17260	9850	11970	6830			8180	4630	(31.6)		
-3.0 m	kg	*12120	*12120	*16820	14680	12880	7040	7750	4400	5390	3070			4420	2550	8.71		
(-10 ft)	lb	*26720	*26720	*37080	32360	28400	15520	17090	9700	11880	6770			9740	5620	(28.6)		
-4.5 m	kg	*15830	*15830	*17940	15050	*12020	7180	7850	4490					*5790	3580	7.30		
(-15 ft)	lb	*34900	*34900	*39550	33180	*26500	15830	17310	9900					*12760	7890	(24.0)		

R260NLC-9A

Boom : 5.85m (19' 2") / Arm : 2.10 m (6' 11") / Bucket : 1.08 m³ (1.41 yd³) SAE heaped / Shoe : 600mm (24") triple grouser

Load point height m(ft)		Load radius						At max. reach					
		3.0 m (10 ft)		4.5 m (15 ft)		6.0 m (20 ft)		7.5 m (25 ft)		Capacity	Reach		
												m (ft)	
6.0 m	kg					*5790	5290				5200	2870	8.32
(20 ft)	lb					*12760	11660				11460	6330	(27.3)
4.5 m	kg			*7810	*7810	*6510	5030	*6000	3310		4500	2410	8.91
(15 ft)	lb			*17220	*17220	*14350	11090	*13230	7300		9920	5310	(29.2)
3.0 m	kg			*10260	7330	*7600	4660	5870	3170		4190	2190	9.17
(10 ft)	lb			*22620	16160	*16760	10270	12940	6990		9240	4830	(30.1)
1.5 m	kg			*12300	6670	8210	4330	5690	3010		4150	2150	9.14
(5 ft)	lb			*27120	14700	18100	9550	12540	6640		9150	4740	(30.0)
Ground	kg			13050	6410	7970	4120	5570	2900		4390	2280	8.80
Line	lb			28770	14130	17570	9080	12280	6390		9680	5030	(28.9)
-1.5 m	kg	*15460	13120	13030	6390	7900	4060				5040	2660	8.13
(-5 ft)	lb	*34080	28920	28730	14090	17420	8950				11110	5860	(26.7)
-3.0 m	kg	*17100	13420	*12090	6540	8020	4160				*6290	3560	6.98
(-10 ft)	lb	*37700	29590	*26650	14420	17680	9170				*13870	7850	(22.9)
-4.5 m	kg	*13360	*13360	*9460	6930								
(-15 ft)	lb	*29450	*29450	*20860	15280								

Boom : 5.85m (19' 2") / Arm : 2.50 m (8' 2") / Bucket : 1.08 m³ (1.41 yd³) SAE heaped / Shoe : 600mm (24") triple grouser

Load point height m(ft)		Load radius						At max. reach						
		1.5 m (5 ft)		3.0 m (10 ft)		4.5 m (15 ft)		6.0 m (20 ft)		7.5 m (25 ft)		Capacity	Reach	
													m (ft)	
6.0 m	kg											4880	2680	8.67
(20 ft)	lb											10760	5910	(28.4)
4.5 m	kg							*6070	5130	*5630	3380	4260	2270	9.23
(15 ft)	lb							*13380	11310	*12410	7450	9390	5000	(30.3)
3.0 m	kg					*9550	7530	*7210	4750	5920	3210	3970	2070	9.48
(10 ft)	lb					*21050	16600	*15900	10470	13050	7080	8750	4560	(31.1)
1.5 m	kg					*11790	6790	8270	4380	5720	3030	3930	2020	9.45
(5 ft)	lb					*25990	14970	18230	9660	12610	6680	8660	4450	(31.0)
Ground	kg					*12990	6440	7990	4140	5570	2900	4130	2120	9.13
Line	lb					*28640	14200	17610	9130	12280	6390	9110	4670	(30.0)
-1.5 m	kg			*15100	12930	12990	6350	7880	4040	5520	2850	4670	2440	8.49
(-5 ft)	lb			*33290	28510	28640	14000	17370	8910	12170	6280	10300	5380	(27.9)
-3.0 m	kg	*16360	*16360	*18120	13210	*12470	6450	7940	4090			5910	3170	7.41
(-10 ft)	lb	*36070	*36070	*39950	29120	*27490	14220	17500	9020			13030	6990	(24.3)
-4.5 m	kg			*14860	13750	*10430	6760							
(-15 ft)	lb			*32760	30310	*22990	14900							

- Lifting capacity is based on SAE J1097, ISO 10567.
- Lifting capacity of the Robex Series does not exceed 75% of the tipping load with the machine on firm, level ground or 87% of full hydraulic capacity.
- The load point is a hook located on the back of the bucket.
- (*) indicates the load limited by hydraulic capacity.

Lifting Capacity

R260NLC-9A

Rating over-front Rating over-side or 360 degree

Boom : 5.85m (19' 2") / Arm : 3.05 m (10' 0") / Bucket : 1.08 m³ (1.41 yd³) SAE heaped / Shoe : 600mm (24") triple grouser

Load point height m(ft)	Load radius										At max. reach				
	1.5 m (5 ft)		3.0 m (10 ft)		4.5 m (15 ft)		6.0 m (20 ft)		7.5 m (25 ft)		Capacity		Reach m (ft)		
6.0 m (20 ft)	kg										*3700	3570	4380	2370	9.22
	lb										*8160	7870	9660	5220	(30.2)
4.5 m (15 ft)	kg							*5350	5230	*5060	3440	3860	2020	9.74	
	lb							*11790	11530	*11160	7580	8510	4450	(32.0)	
3.0 m (10 ft)	kg			*13640	*13640	*8400	7780	*6540	4830	*5660	3240	3610	1840	9.98	
	lb			*30070	*30070	*18520	17150	*14420	10650	*12480	7140	7960	4060	(32.7)	
1.5 m (5 ft)	kg			*9450	*9450	*10870	6940	*7820	4420	5720	3030	3560	1790	9.95	
	lb			*20830	*20830	*23960	15300	*17240	9740	12610	6680	7850	3950	(32.6)	
Ground	kg			*10570	*10570	*12490	6430	7980	4120	5530	2850	3710	1860	9.65	
	lb			*23300	*23300	*27540	14180	17590	9080	12190	6280	8180	4100	(31.7)	
-1.5 m (-5 ft)	kg	*9940	*9940	*13870	12620	12870	6250	7790	3960	5430	2760	4130	2100	9.05	
	lb	*21910	*21910	*30580	27820	28370	13780	17170	8730	11970	6080	9110	4630	(29.7)	
-3.0 m (-10 ft)	kg	*13540	*13540	*18430	12840	*12780	6270	7780	3950			5060	2640	8.06	
	lb	*29850	*29850	*40630	28310	*28180	13820	17150	8710			11160	5820	(26.4)	
-4.5 m (-15 ft)	kg	*17830	*17830	*16580	13290	*11360	6490	7980	4120			*5940	4010	6.48	
	lb	*39310	*39310	*36550	29300	*25040	14310	17590	9080			*13100	8840	(21.3)	

Boom : 5.85m (19' 2") / Arm : 3.60 m (11' 10") / Bucket : 1.08 m³ (1.41 yd³) SAE heaped / Shoe : 600mm (24") triple grouser

Load point height m(ft)	Load radius										At max. reach					
	1.5 m (5 ft)		3.0 m (10 ft)		4.5 m (15 ft)		6.0 m (20 ft)		7.5 m (25 ft)		9.0 m (30 ft)		Capacity		Reach m (ft)	
6.0 m (20 ft)	kg									*3930	3660			3940	2090	9.77
	lb									*8660	8070			8690	4610	(32.1)
4.5 m (15 ft)	kg									*4530	3510	*2500	2350	3510	1790	10.27
	lb									*9990	7740	*5510	5180	7740	3950	(33.7)
3.0 m (10 ft)	kg							*5890	4940	*5190	3290	*3590	2250	3290	1630	10.49
	lb							*12990	10890	*11440	7250	*7910	4960	7250	3590	(34.4)
1.5 m (5 ft)	kg			*12610	*12610	*9960	7160	*7260	4510	5760	3060	4180	2130	3240	1580	10.46
	lb			*27800	*27800	*21960	15790	*16010	9940	12700	6750	9220	4700	7140	3480	(34.3)
Ground	kg			*11020	*11020	*11930	6540	8030	4160	5540	2860	4070	2030	3360	1640	10.18
	lb			*24290	*24290	*26300	14420	17700	9170	12210	6310	8970	4480	7410	3620	(33.4)
-1.5 m (-5 ft)	kg	*9010	*9010	*13200	12560	12890	6250	7790	3950	5400	2730			3690	1830	9.62
	lb	*19860	*19860	*29100	27690	28420	13780	17170	8710	11900	6020			8140	4030	(31.6)
-3.0 m (-10 ft)	kg	*12120	*12120	*16820	12660	12820	6190	7710	3880	5370	2700			4390	2240	8.71
	lb	*26720	*26720	*37080	27910	28260	13650	17000	8550	11840	5950			9680	4940	(28.6)
-4.5 m (-15 ft)	kg	*15830	*15830	*17940	13010	*12020	6330	7820	3970					*5790	3190	7.30
	lb	*34900	*34900	*39550	28680	*26500	13960	17240	8750					*12760	7030	(24.0)

R260LC-9A HIGH WALKER

Rating over-front Rating over-side or 360 degree

Boom : 5.85m (19' 2") / Arm : 2.10 m (6' 11") / Bucket : 1.08 m³ (1.41 yd³) SAE heaped / Shoe : 600mm (24") triple grouser

Load point height m(ft)	Load radius						At max. reach					
	3.0 m (10 ft)		4.5 m (15 ft)		6.0 m (20 ft)		7.5 m (25 ft)		Capacity		Reach m (ft)	
6.0 m (20 ft)	kg					*5910	*5910			*5290	3780	8.49
	lb					*13030	*13030			*11660	8330	(27.9)
4.5 m (15 ft)	kg			*8350	*8350	*6750	6680	*6080	4530	5310	3310	9.00
	lb			*18410	*18410	*14880	14730	*13400	9990	11710	7300	(29.5)
3.0 m (10 ft)	kg			*10830	9880	*7870	6290	*6580	4370	5040	3110	9.19
	lb			*23880	21780	*17350	13870	*14510	9630	11110	6860	(30.2)
1.5 m (5 ft)	kg			*12610	9280	*8890	5970	6840	4210	5080	3120	9.09
	lb			*27800	20460	*19600	13160	15080	9280	11200	6880	(29.8)
Ground	kg			*13240	9080	*9480	5790	6740	4120	5450	3360	8.68
	lb			*29190	20020	*20900	12760	14860	9080	12020	7410	(28.5)
-1.5 m (-5 ft)	kg	*17510	*17510	*12940	9100	*9460	5760			*6350	3950	7.91
	lb	*38600	*38600	*28530	20060	*20860	12700			*14000	8710	(26.0)
-3.0 m (-10 ft)	kg	*16440	*16440	*11670	9310	*8440	5920			*6190	5420	6.61
	lb	*36240	*36240	*25730	20530	*18610	13050			*13650	11950	(21.7)













- Lifting capacity is based on SAE J1097, ISO 10567.
- Lifting capacity of the Robex Series does not exceed 75% of the tipping load with the machine on firm, level ground or 87% of full hydraulic capacity.
- The load point is a hook located on the back of the bucket.
- (*) indicates the load limited by hydraulic capacity.

Lifting Capacity













R260LC-9A HIGH WALKER

 Rating over-front  Rating over-side or 360 degree















Boom : 5.85m (19' 2") / Arm : 2.50 m (8' 2") / Bucket : 1.08 m³ (1.41 yd³) SAE heaped / Shoe : 600mm (24") triple grouser

Load point height m(ft)		Load radius										At max. reach		
		1.5 m (5 ft)		3.0 m (10 ft)		4.5 m (15 ft)		6.0 m (20 ft)		7.5 m (25 ft)		Capacity		Reach
														m (ft)
6.0 m	kg							*5440	*5440			*4950	3560	8.83
(20 ft)	lb							*11990	*11990			*10910	7850	(29.0)
4.5 m	kg					*7630	*7630	*6320	*6320	*5730	4600	5030	3140	9.32
(15 ft)	lb					*16820	*16820	*13930	*13930	*12630	10140	11090	6920	(30.6)
3.0 m	kg					*10140	10080	*7500	6380	*6300	4410	4790	2950	9.50
(10 ft)	lb					*22350	22220	*16530	14070	*13890	9720	10560	6500	(31.2)
1.5 m	kg					*12180	9390	*8620	6020	6860	4230	4810	2940	9.40
(5 ft)	lb					*26850	20700	*19000	13270	15120	9330	10600	6480	(30.8)
Ground	kg					*13120	9090	*9350	5800	6730	4110	5120	3140	9.01
Line	lb					*28920	20040	*20610	12790	14840	9060	11290	6920	(29.6)
-1.5 m	kg	*12120	*12120	*16630	*16630	*13100	9050	*9510	5730			5900	3640	8.28
(-5 ft)	lb	*26720	*26720	*36660	*36660	*28880	19950	*20970	12630			13010	8020	(27.2)
-3.0 m	kg	*17840	*17840	*17530	*17530	*12140	9210	*8850	5830			*6280	4810	7.07
(-10 ft)	lb	*39330	*39330	*38650	*38650	*26760	20300	*19510	12850			*13850	10600	(23.2)
-4.5 m	kg			*13700	*13700	*9570	*9570							
(-15 ft)	lb			*30200	*30200	*21100	*21100							

Boom : 5.85m (19' 2") / Arm : 3.05 m (10' 0") / Bucket : 1.08 m³ (1.41 yd³) SAE heaped / Shoe : 600mm (24") triple grouser

Load point height m(ft)		Load radius										At max. reach		
		1.5 m (5 ft)		3.0 m (10 ft)		4.5 m (15 ft)		6.0 m (20 ft)		7.5 m (25 ft)		Capacity		Reach
														m (ft)
6.0 m	kg									*4140	*4140	*4510	3190	9.37
(20 ft)	lb									*9130	*9130	*9940	7030	(30.7)
4.5 m	kg							*5610	*5610	*5180	4650	4590	2830	9.82
(15 ft)	lb							*12370	*12370	*11420	10250	10120	6240	(32.2)
3.0 m	kg			*15320	*15320	*9030	*9030	*6850	6450	*5830	4430	4370	2660	9.99
(10 ft)	lb			*33770	*33770	*19910	*19910	*15100	14220	*12850	9770	9630	5860	(32.8)
1.5 m	kg			*9310	*9310	*11350	9510	*8090	6050	*6510	4220	4380	2650	9.90
(5 ft)	lb			*20530	*20530	*25020	20970	*17840	13340	*14350	9300	9660	5840	(32.5)
Ground	kg	*7350	*7350	*11240	*11240	*12710	9060	*9010	5760	6680	4060	4620	2800	9.53
Line	lb	*16200	*16200	*24780	*24780	*28020	19970	*19860	12700	14730	8950	10190	6170	(31.3)
-1.5 m	kg	*10760	*10760	*14820	*14820	*13100	8920	*9410	5640	6610	3990	5220	3180	8.85
(-5 ft)	lb	*23720	*23720	*32670	*32670	*28880	19670	*20750	12430	14570	8800	11510	7010	(29.0)
-3.0 m	kg	*14470	*14470	*18710	*18710	*12560	9000	*9130	5660			*6000	4040	7.76
(-10 ft)	lb	*31900	*31900	*41250	*41250	*27690	19840	*20130	12480			*13230	8910	(25.5)
-4.5 m	kg			*15670	*15670	*10780	9290							
(-15 ft)	lb			*34550	*34550	*23770	20480							

Boom : 5.85m (19' 2") / Arm : 3.60 m (11' 10") / Bucket : 1.08 m³ (1.41 yd³) SAE heaped / Shoe : 600mm (24") triple grouser

Load point height m(ft)		Load radius												At max. reach		
		1.5 m (5 ft)		3.0 m (10 ft)		4.5 m (15 ft)		6.0 m (20 ft)		7.5 m (25 ft)		9.0 m (30 ft)		Capacity		Reach
																m (ft)
6.0 m	kg									*4150	*4150			*4120	2870	9.92
(20 ft)	lb									*9150	*9150			*9080	6330	(32.5)
4.5 m	kg									*4670	*4670	*2810	*2810	4190	2560	10.34
(15 ft)	lb									*10300	*10300	*6190	*6190	9240	5640	(33.9)
3.0 m	kg			*12560	*12560	*7950	*7950	*6220	*6220	*5370	4480	*3790	3200	4000	2410	10.50
(10 ft)	lb			*27690	*27690	*17530	*17530	*13710	*13710	*11840	9880	*8360	7050	8820	5310	(34.4)
1.5 m	kg			*11430	*11430	*10510	9730	*7570	6130	*6140	4240	*4350	3070	4000	2390	10.42
(5 ft)	lb			*25200	*25200	*23170	21450	*16690	13510	*13540	9350	*9590	6770	8820	5270	(34.2)
Ground	kg	*6810	*6810	*11370	*11370	*12250	9150	*8650	5800	6680	4050	*4060	2980	4200	2510	10.07
Line	lb	*15010	*15010	*25070	*25070	*27010	20170	*19070	12790	14730	8930	*8950	6570	9260	5530	(33.0)
-1.5 m	kg	*9710	*9710	*13930	*13930	*13000	8910	*9270	5610	6560	3940			4670	2810	9.44
(-5 ft)	lb	*21410	*21410	*30710	*30710	*28660	19640	*20440	12370	14460	8690			10300	6190	(31.0)
-3.0 m	kg	*12930	*12930	*17900	*17900	*12840	8900	*9280	5580	6560	3940			5650	3450	8.43
(-10 ft)	lb	*28510	*28510	*39460	*39460	*28310	19620	*20460	12300	14460	8690			12460	7610	(27.7)
-4.5 m	kg	*16850	*16850	*17220	*17220	*11600	9100	*8340	5720					*5770	5000	6.86
(-15 ft)	lb	*37150	*37150	*37960	*37960	*25570	20060	*18390	12610					*12720	11020	(22.5)

- Lifting capacity is based on SAE J1097, ISO 10567.
- Lifting capacity of the Robex Series does not exceed 75% of the tipping load with the machine on firm, level ground or 87% of full hydraulic capacity.
- The load point is a hook located on the back of the bucket.
- (*) indicates the load limited by hydraulic capacity.

STANDARD EQUIPMENT

ISO Standard cabin

All-weather steel cab with 360° visibility
Safety glass windows
Rise-up type windshield wiper
Sliding fold-in front window
Sliding side window(LH)
Lockable door
Hot & cool box
Storage compartment & Ashtray
Radio & USB player
Handsfree mobile phone system with USB
Transparent cabin roof-cover
12 volt power outlet (24V DC to 12V DC converter)
Sun visor

Computer aided power optimization (New CAPO) system

3-power mode, 2-work mode, User mode
Auto deceleration & one-touch deceleration system
Auto warm-up system
Auto overheat prevention system

Automatic climate control

Air conditioner & heater
Defroster

Self-diagnostics system

Starting Aid (air grid heater) for cold weather

Centralized monitoring

LCD display
Engine speed or Trip meter/Accel.
Clock
Gauges
Fuel level gauge
Engine coolant temperature gauge
Hyd. oil temperature gauge
Warnings
Check engine
Overload
Communication error
Low battery
Air cleaner clogging
Indicators
Max power
Low speed/High speed
Fuel warmer
Auto idle

Door and cab locks, one key

Three outside rearview mirrors

Mechanical suspension seat with heater

Pilot-operated slidable joystick

Console box height adjust system

Four front working lights

Electric horn

Batteries (2 x 12V x 100 AH)

Battery master switch

Removable clean-out dust net for cooler

Automatic swing brake

Removable reservoir tank

Fuel pre-filter with fuel warmer

Boom holding system

Arm holding system

Track shoes (600mm, 24")

Track rail guard

Accumulator for lowering work equipment

Electric transducer

Lower frame under cover (Normal)

Viscous fan clutch

OPTIONAL EQUIPMENT

Fuel filler pump (50 L/min)

Beacon lamp

Safety lock valve for boom cylinder with overload warning device

Safety lock valve for arm cylinder

Single-acting piping kit (breaker, etc.)

Double-acting piping kit (clamshell, etc.)

Quick coupler

Travel alarm

Booms

5.85 m, 19' 2"

5.85 m, 19' 2" Heavy duty

Arms

2.1 m, 6' 11"

2.5 m, 8' 2"

3.05 m, 10' 0"

3.6 m, 11' 10"

3.05 m, 10' 0" Heavy duty

Cabin FOPS/FOG (ISO/DIS 10262 Level II)

FOPS (Falling Object Protective Structure)

FOG (Falling Object Guard)

Cabin ROPS (ISO 12117-2)

ROPS (Roll Over Protective Structure)

Cabin roof-steel cover

Cabin lights

Cabin front window rain guard

Track shoes

Triple grousers shoe (700mm, 28")

Triple grousers shoe (800mm, 32")

Triple grousers shoe (900mm, 36")

Double grousers shoe (700mm, 28")

Full track rail guard (High walker only)

Lower frame under cover (Additional)

Pre-heating system, coolant

Tool kit

Operator suit

Rearview camera

Seat

Adjustable air suspension seat with heater

Pattern change valve (2 patterns)

Hi-mate (Remote Management System)

- * Standard and optional equipment may vary. Contact your Hyundai dealer for more information. The machine may vary according to International standards.
- * The photos may include attachments and optional equipment that are not available in your area.
- * Materials and specifications are subject to change without advance notice.
- * All imperial measurements rounded off to the nearest pound or inch.

PLEASE CONTACT



6100 Atlantic Blvd Norcross, GA 30071
TEL (678) 823 7777 FAX (678) 823 7778