

KOMATSU®

HD785-8

Tier 4 Final Engine

OFF-HIGHWAY TRUCK

HD785



Photos may include optional equipment.

HORSEPOWER

Gross: 1200 HP 895 kW @ 1900 rpm
Net: 1140 HP 849 kW @ 1900 rpm

RATED PAYLOAD

101.6 US tons 92.2 metric tons

BODY CAPACITY

Heaped (SAE 2:1): 78.5 yd³ 60.0 m³

WALK-AROUND

HD785-8

PRODUCTIVITY FEATURES

- Automatic Retard Speed Control (ARSC) allows the operator to set and maintain a constant downhill travel speed
- High performance Komatsu SAA12V140E-7 engine (net 1,140 HP/849 kW) provides high productivity on grade
- Komatsu Traction Control System (KTCS) monitors for wheel spin and automatically applies brakes independently for optimum traction in various ground conditions
- No use of Selective Catalytic Reduction (SCR) or Diesel Exhaust Fluid (DEF)
- Oil cooled, multiple-disc brakes on all four wheels provide high retarding capability (1,770 HP/1320 kW)
- Seven-speed, fully automatic K-ATOMICs transmission with 2 selectable reverse speeds and skip shift function
- Tight turning radius: 10.1 m 33' 2"
- Variable Geometry Turbocharger (VGT) is hydraulically actuated to provide optimum air flow under various speed and load conditions



Photos may include optional equipment.

HORSEPOWER

Gross: 1200 HP 895 kW @ 1900 rpm
Net: 1140 HP 849 kW @ 1900 rpm

RATED PAYLOAD

101.6 US tons 92.2 metric tons

BODY CAPACITY

Heaped (SAE 2:1): 78.5 yd³ 60.0 m³

PRODUCTIVITY AND EFFICIENCY

The Komatsu SAA12V140E-7 engine provides high performance on grade and oil cooled, multiple disc brakes on all four wheels provide high retarding capability. A new, upgraded cab with standard KomVision all around machine monitoring system keeps operators comfortable and productive during long shifts.

OPERATOR ENVIRONMENT

- Air suspension, heated & ventilated operator seat with three-point seat belt and standard trainer seat with lap belt
- Automatic climate control system
- Diagonal access stairway with handrails for easy access
- Front and rear hydropneumatic suspension provides a smooth ride
- Heated rearview mirrors
- KomVision provides bird's-eye view utilizing 6-camera system on dedicated display
- LED head lamps (high and low beam), side lamps, and rear combination lamps
- Machine monitor with high resolution 7-inch color LCD display
- Rearview monitoring system on dedicated display
- Viscous cab mounts for a quiet, comfortable ride

ECOLOGY AND ECONOMY

- Auto Idle Setting System (AISS) for quick machine warm up
- Auto Idle Shutdown helps reduce idle time and operating costs
- Energy savings operation ecology guidance
- Hydraulically operated, reversible fan
- Komatsu SAA12V140E-7 engine is EPA Tier 4 Final emissions certified
- Mode selection system with variable horsepower control

RELIABILITY FEATURES

- 10-10-20 payload policy
- Engine pre-lubrication system
- High rigidity frame
- Integrated Payload Meter (PLM)
- Robust dump body design

MAINTENANCE FEATURES

- Advanced monitoring system with onboard diagnostics, no laptop required
- Anchored tie off points (ISO 14567) around the machine provide technicians locations to attach service lanyards
- Centralized ground level access arrangement of filters and greasing points
- Fast fuel fill coupler
- Ground level battery isolator, starter isolator and machine immobilization switch with lockout / tagout capabilities
- Ground level service center for fluid fill and evacuation
- Jump start receptacle
- KOMTRAX Plus allows remote access to maintenance and performance information
- Modular radiator core system



ECOLOGY AND ECONOMY FEATURES

NEW ENGINE TECHNOLOGIES

Komatsu's New Emission Regulation-compliant Engine

Komatsu provides a powerful and economical U.S. EPA Tier 4 Final compliant engine with the latest emission control technologies and fuel saving features.

- ① Komatsu Diesel Particulate Filter (KDPF)
- ② Variable Geometry Turbocharger (VGT)
- ③ Exhaust Gas Recirculation (EGR) cooler

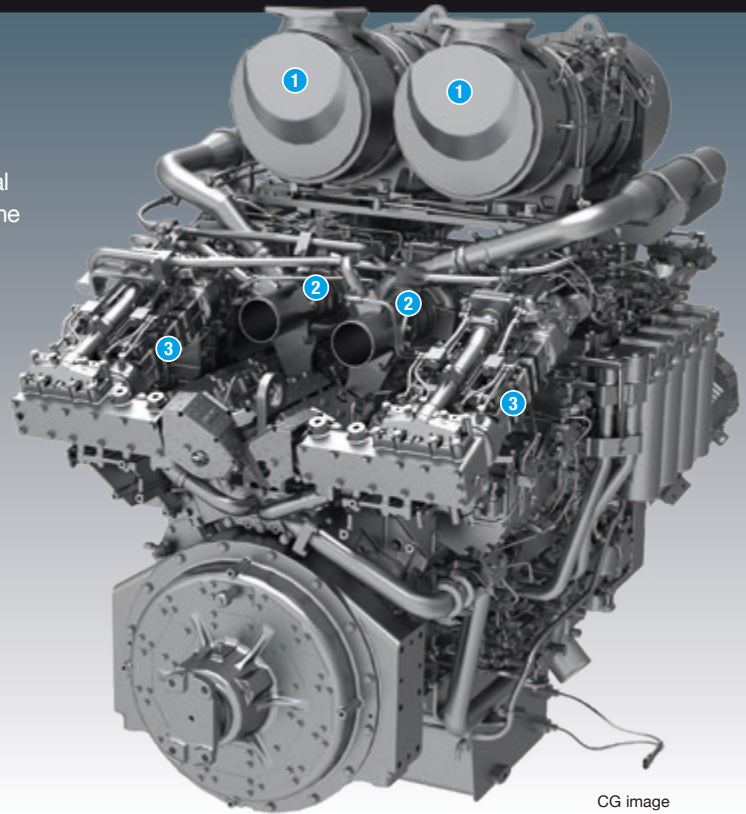

CG image

Heavy-Duty Aftertreatment System

The Komatsu Diesel Particulate Filters (KDPFs) capture more than 90% of Particulate Matter (PM). The KDPFs include a special oxidation catalyst to facilitate decomposition of most PM without operator action and no need to interrupt normal operation.

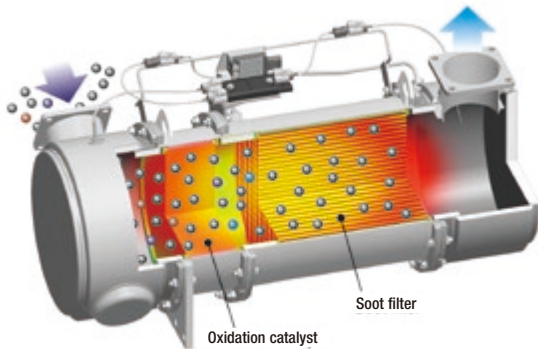

Variable Geometry Turbocharger (VGT) System

The VGT system uses proven, Komatsu-designed hydraulic technology for variable control of airflow, and supplies optimal air based on load conditions.

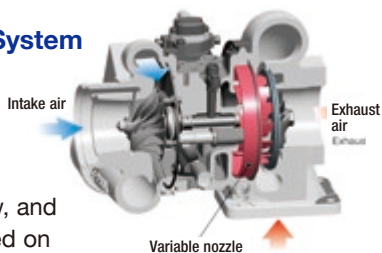

Heavy-Duty Cooled Exhaust Gas Recirculation (EGR) System

The system recirculates a portion of exhaust gas into the air intake and lowers combustion temperatures. The system dramatically reduces NOx and lowers fuel consumption.

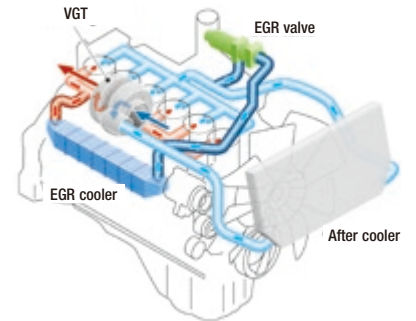

High Pressure Common Rail (HPCR) Fuel Injection System

The system is designed to achieve an optimal injection of high-pressure fuel via computerized control, providing near-complete combustion to reduce PM emissions.

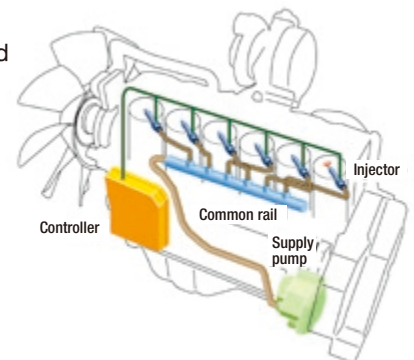

Energy Saving Operation

To support efficient operation, an easy-to-read ecology gauge is included in the machine monitor. The ecology gauge indicates momentary fuel consumption rate during operation. Operating the vehicle with the gauge in the green zone ensures the most energy efficient operation.

The monitor provides ecology guidance to the operator to help promote energy saving operation.

For example, if the operator stops the machine for a long period of time with the engine idling, the monitor will display the message "Avoid long time engine idling".

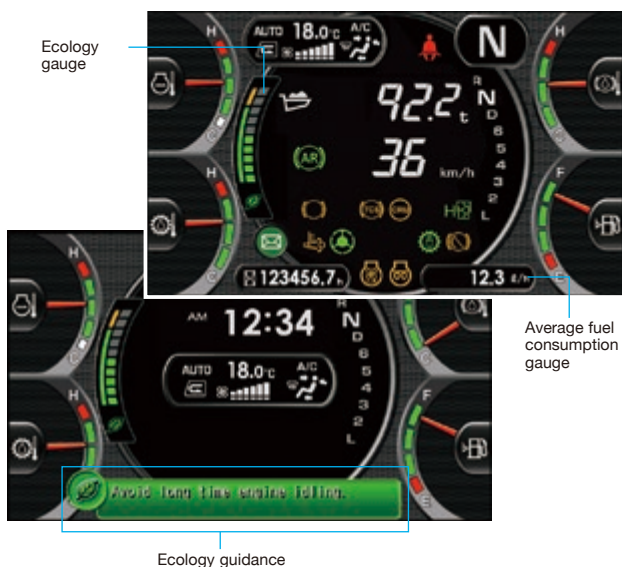

Low Fuel Consumption

Latest Komatsu "on demand" energy saving technologies achieve lower fuel consumption while keeping high productivity.

- Variable displacement piston pumps for steering and hoist circuits
- Improved transmission control hydraulic pressure management
- Controlling engine output according to hydraulic drive fan rotation speed and maintaining constant net output

Brake Cooling Oil Recovery Tank

Brake cooling oil recovery tanks are installed on all four wheels to recover brake cooling oil in the event of brake floating seal leakage.



Auto Idle Shutdown

When the engine is idling for a certain amount of time (adjustable from five to 60 minutes), the engine automatically stops to reduce unnecessary fuel consumption and exhaust emissions.



Selectable Operating Modes

The operator can choose between two operating modes, Economy mode or Power mode, according to machine operating conditions.



Power mode



The Power mode increases the engine maximum output and raises the upshift and downshift engine speeds during operation.

Economy mode

The Economy mode lowers the engine maximum output along with lowering the upshift and downshift engine speeds during operation.

Variable Horsepower Control

Both in Power and Economy modes, the Variable Horsepower Control system automatically detects whether the machine is loaded or unloaded and selects the optimum horsepower setting mode, providing both high production and low fuel consumption.

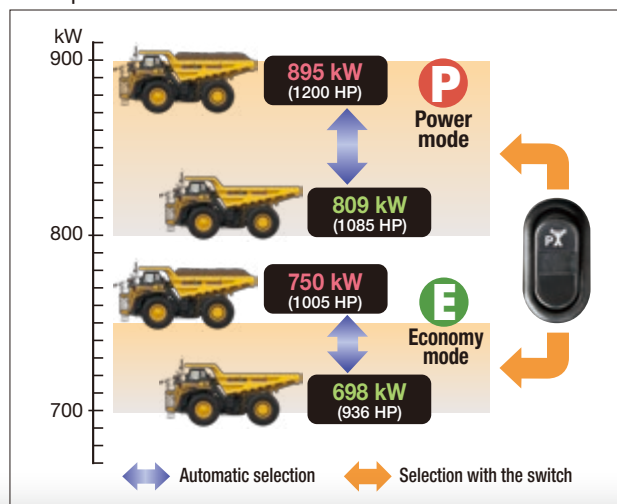

PERFORMANCE FEATURES

HD785-8

High Performance Komatsu SAA12V140E-7 Engine

The powerful and fuel-efficient SAA12V140E-7 engine delivers **1,200 HP** (895 kW) at 1900 rpm. This contributes to fast acceleration on grade and shorter cycles times for high productivity.



Long Wheelbase and Wide Tread

With an extra-long wheelbase, a wide tread, and an exceptionally low center of gravity, the HD785-8 hauls at higher speeds for greater productivity and delivers superior driving comfort over rough terrain.

Small Turning Radius

McPherson strut type front suspension has a special A-arm between each wheel and the main frame. The wider space created between the front wheels and the main frame increases the turning angle of the wheels. The larger turning angle provides a smaller turning radius for the truck.

Minimum Turning Radius: 33'2" 10.1 m

Turning radius varies depending on ground conditions and/or vehicle speed.

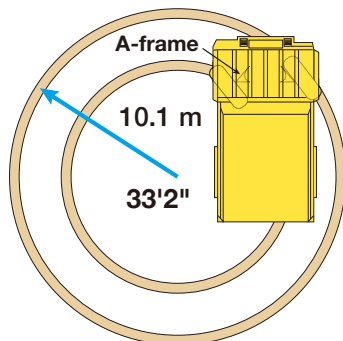

Fully Hydraulic Controlled Wet Multiple-Disc Brakes and Retarder

Wet multiple-disc brakes on all four wheels ensure highly reliable and stable brake performance. The large-capacity, continuously-oil-cooled, multiple-disc brakes also function as a highly responsive retarder, which gives the operator greater confidence at higher downhill speeds.

Retarder Absorption Capacity: 1,770 HP 1320 kW

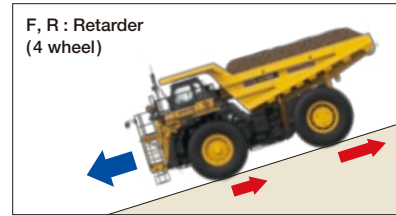

Komatsu Advanced Transmission with Optimum Modulation Control System (K-ATOMiCS) with Skip Shift Function

The transmission has 7 forward and 1 reverse shift. The reverse gear has 2 selectable gear ratios (high/low) to meet various operating conditions. Fully automatic control selects the optimum gear according to vehicle speed and the engine speed. The shift point automatically changes depending on the acceleration of the vehicle, avoiding unnecessary fuel consumption.



Skip Shift Function

The skip shift function automatically selects a gear position depending on the grade. This eliminates the need to shift down through each gear when traveling uphill. It also reduces the number of downshifts, resulting in a smoother ride, improving operator comfort, and reducing material spillage.

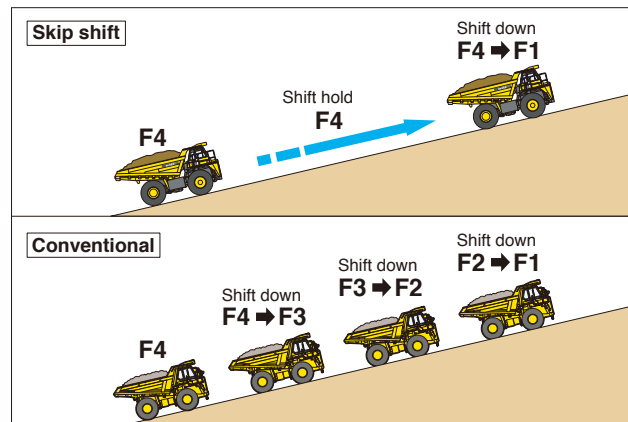

Automatic Retard Speed Control (ARSC)

ARSC allows the operator to set the downhill travel speed at a constant speed. This allows the operator to concentrate on steering. The speed can be set at increments of **0.6 mph** 1 km/h per click (+/- **3.1 mph** 5 km/h of maximum speed adjustment) to match the optimum speed for the slope. The retarder cooling oil is continuously monitored and the travel speed is automatically lowered if the oil temperature increases to a set limit.



Automatic Idling Setting System (AISS)

This system facilitates quick engine warm-up and operator cab cooling/warming. When setting the system ON, engine idle speed is kept at 945 rpm, but is lowered to 650 rpm when the coolant temperature rises. Speed automatically returns to 945 rpm when the coolant temperature drops.



Komatsu Traction Control System (KTCS)

New KTCS ensures optimum traction in soft or wet road conditions. The system monitors for wheel slippage at the rear axle, and an acceleration sensor determines if a high speed turn or wheel slippage is occurring.

If slippage is detected, the brakes are applied independently to each wheel set for optimum traction. This function occurs automatically without operator input and steering performance is not compromised as with a differential lock system.

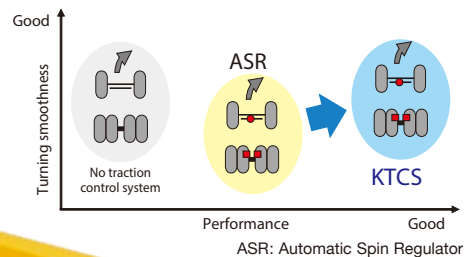
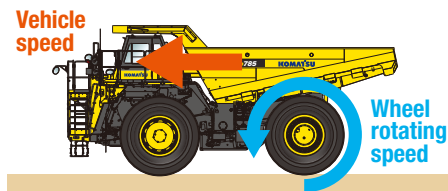

OPERATOR COMFORT



Ergonomically Designed Cab

The ergonomically designed operator's compartment provides the operator a convenient control layout and comfortable environment for more comfortable operation and greater productivity.



Air Suspension Seat

The heated and ventilated, air suspension seat is adjustable to the operator's weight. The air suspension seat dampens vibrations transmitted from the machine to reduce operator fatigue. A three-point operator seat belt is standard.

Trainer Seat

The trainer seat includes a two-point retractable seat belt. Seat comfort has been significantly improved.

Automatic Climate Control System

The automatic climate control system allows the operator to easily set and maintain the desired cab ambient temperature. Excellent heating/cooling capacity and air flow keep the cab environment comfortable throughout the year.

Tilt-Away and Telescoping Steering Column

The tilt steering column and telescopic steering wheel allow the operator to set the steering wheel to the desired position. The tilt mechanism incorporates a spring assist for easy adjustment.



Radio with Bluetooth, AUX, & USB

The AM/FM radio is equipped with bluetooth, aux, and usb inputs allowing the operator to connect to the speakers in the cab.



Storage Spaces

Generous storage spaces are provided throughout the cab including a glove box, lunch box tray, hot or cool box, and cup holder.



Lunch box tray



Hot or cool box, cup holder

Low Noise Design

The spacious cab is mounted with large-capacity viscous mounts. The low-noise engine, hydraulically-driven cooling fan, cab sealing design, and double cab floor structure provide a quiet, low-vibration, and comfortable operating environment.

Noise Level at Operator's Ear

72 dB(A) (SAE J1166)

DC12V Outlet

Two DC12V outlets are standard in the operator's cab. A 12 V cigarette lighter is located on the front side of the center console and an additional 12 V outlet is located on the rear cover behind the operator seat.

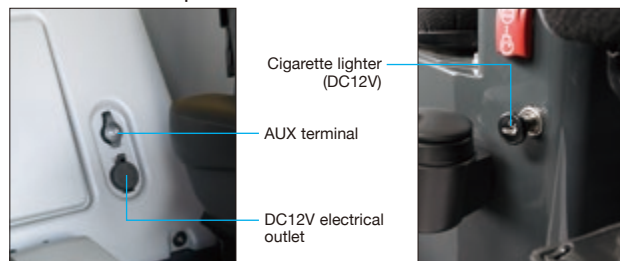

Electronic Hoist Control

The hoist control lever can be operated with minimal effort. A "kick-out function" eliminates the need to hold the lever in the raise position. Body seating shock is significantly reduced by the use of a positioning sensor that reduces the lowering speed just before the body seats on the main frame.



Rear Hydropneumatic Suspension

The hydropneumatic suspension provides a smoother ride over rough terrain to maximize production and operator comfort.

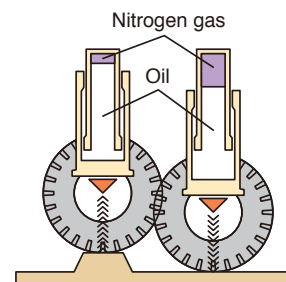

McPherson Strut Type Front Suspension

McPherson strut type independent suspension is used on the front wheels. The linkage arrangement is a low friction design that allows the front wheels to follow uneven road surfaces smoothly for a comfortable ride. The A-arm design significantly reduces turning radius for increased maneuverability and production.

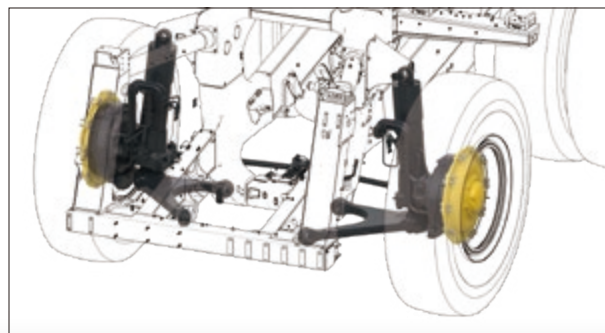
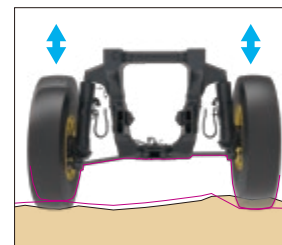

GENERAL FEATURES



HD785-8

KomVision, All Around Monitoring System

The 6-camera system provides the operator with a bird's-eye view of the working area around the machine on a dedicated monitor located in the dash. Two screen mode allows the bird's-eye view and any of the 6 cameras to be viewed simultaneously on the monitor.

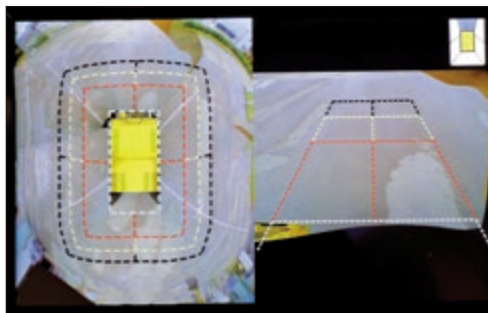

Rear View Monitor System

The operator can view behind the vehicle on the dedicated monitor located in the upper right corner of the cab. This monitor can be always ON, or only when the shift lever is in the reverse position. Visual distance guidelines can be added for the operator's convenience.



Rear view monitor

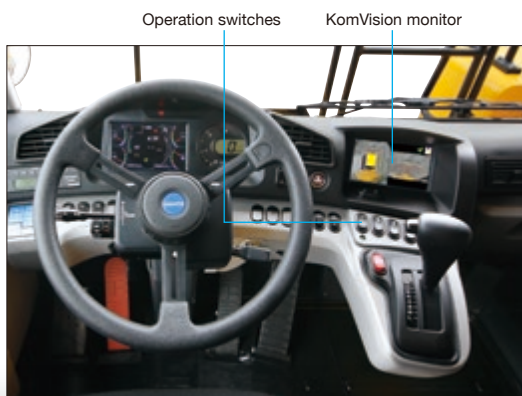

Operation switches

KomVision monitor



Rear view monitor



Rear view camera

KomVision camera

Built-in ROPS/FOPS Cab

Operator cab structure conforms to ISO 3471 ROPS standard, and ISO 3449 FOPS Level II standard.



Secondary Engine Shutdown Switch

A secondary engine shutdown switch is located in the cab for emergency use.



Secondary Steering

The secondary steering system is automatically activated if the steering circuit hydraulic pressure lowers due to a hydraulic system failure. This can also be activated manually by the secondary steering switch in the cab. The pilot lamp on the LCD monitor tells the operator that the system is operable when turning the key switch on.



Manual secondary steering switch

LED Lighting Package

LED lamps are standard for the head lamps (high & low beam), turn signals/hazard lamps, side working lamps, and rear combination lamps. The LED lamps feature a long service life and excellent visibility. Halogen fog lamps are standard.

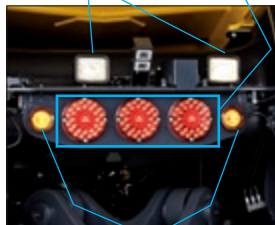

Turn signal & hazard lamp

Secondary Brake

Secondary brakes are a standard feature. This system is operated by the use of the left brake pedal and utilizes an independent hydraulic circuit to simultaneously apply the front and rear parking brakes.

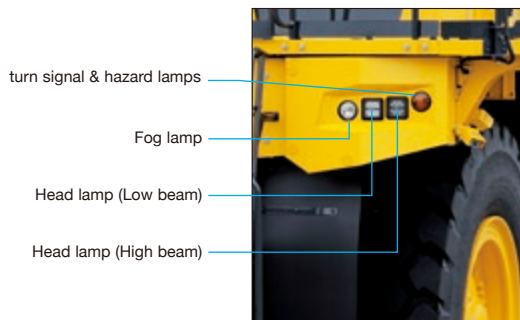

turn signal & hazard lamps

Fog lamp

Head lamp (Low beam)

Head lamp (High beam)

Protection Functions Supported by Electronic Control

Item	Function
Downshift inhibitor	Even in the driver downshifts accidentally, a speed appropriate to the current gear is automatically set, limiting potential over-runs.
Over-run inhibitor	When descending grades, if the vehicle's speed surpasses the maximum for the current gear, the rear brakes automatically apply, limiting potential over-runs.
Reverse inhibitor	The vehicle is prevented from shifting to reverse gear when operating the body.
Forward/Reverse shift inhibitor	This device makes it impossible to shift from/to forward to/from reverse when the vehicle's speed exceeds 4 km/h 2.5 mph.
Anti-hunting system	When running near the shift point, the system prevents unnecessary shift up and down for smooth traveling.
Neutral safety	The engine is prevented from starting when the shift lever is not in neutral.
Neutral coast inhibitor	It prevents gear position from shifting to neutral while traveling over a certain speed, even if the shift lever is moved to neutral position.

Diagonal Access Stairway

The low angle diagonal stairway provides easy access to the cab and deck. Ladders with gates and handrails are provided on both the left and right sides as secondary egress.



Dimpled Slip-Resistant Plates

Stairways and walkways are made with dimpled, slip-resistant plates for better traction.

TECHNOLOGY

MACHINE MONITOR WITH LARGE HIGH RESOLUTION LCD UNIT

Machine Monitor

The machine monitor displays machine information and provides access to machine settings.

Switch Panel

The switch panel is used to select various LCD screens and the air conditioner control screen. By using the switch panel, users can display user menus on the LCD screen and access machine settings and conditions. A keypad provides simple and easy navigation to machine operation information.

Large Multi-Lingual LCD Monitor

A large, user-friendly color monitor provides excellent screen visibility via a liquid crystal display that is easily read at various angles and lighting conditions.

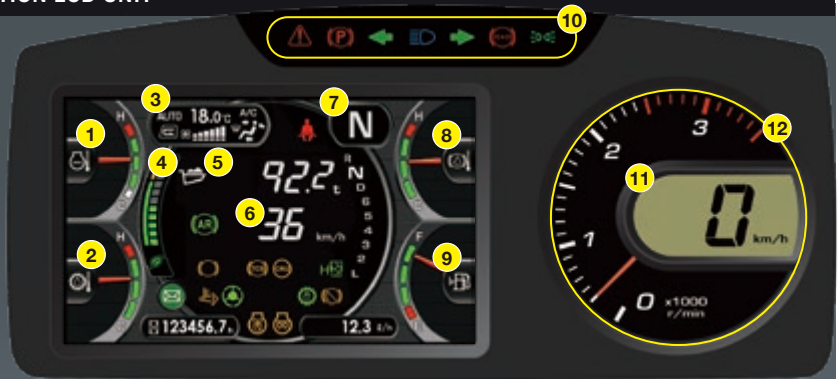

Machine Monitor

- | | |
|--|----------------------------------|
| 1 Engine coolant temperature gauge | 7 Shift indicator |
| 2 Torque converter oil temperature gauge | 8 Retarder oil temperature gauge |
| 3 A/C display | 9 Fuel gauge |
| 4 ECO gauge | 10 LED indicator |
| 5 Payload / clock | 11 Speedometer |
| 6 ARSC set travel speed | 12 Engine tachometer |

Switch Panel

- 1 Air conditioner (A/C) switches / Numeral key pad
- 2 Function switches

Maintenance Reminders

When the time remaining to the next scheduled maintenance is less than the preset hours*, the maintenance time monitor appears. *The time can be set in the 10 to 200 hour range.

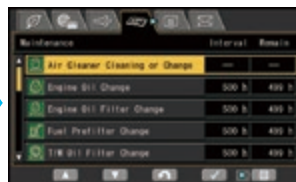

Maintenance screen

Troubleshooting Function

Various meters, gauges, and warning functions are centrally arranged on the LCD unit. This unit facilitates the start-up inspection and promptly warns the operator with a lamp and a buzzer if any abnormality occurs. Each abnormal condition is indicated in one of four recommended action levels.



Visual User Menu

Pressing the menu switch on the switch panel displays the user menu screen. The menus are grouped by their functions. Easy-to-understand icons enable intuitive use.

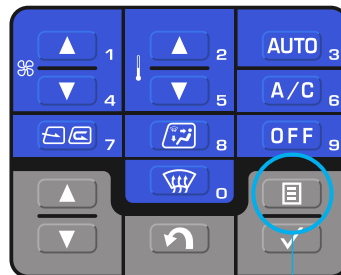

Menu switch



- | | | |
|--|---|--|
| <p>1 Energy saving guidance</p> <ul style="list-style-type: none"> • Operation records • Ecology guidance records • Average fuel consumption record • Configurations <p>2 Machine setting / information</p> <ul style="list-style-type: none"> • Radiator fan reverse mode • KTCS setting etc. | <p>3 Aftertreatment devices regeneration</p> <ul style="list-style-type: none"> • Setting regeneration disable • Operation of manual stationary regeneration <p>4 Maintenance</p> <ul style="list-style-type: none"> • Check and reset of various maintenance remainings | <p>5 Monitor setting</p> <ul style="list-style-type: none"> • Language setting (27 languages) • Rear view monitor setting • Measurement unit setting • Screen brightness adjustment etc. <p>6 Mail check</p> |
|--|---|--|

RELIABILITY FEATURES

High-rigidity Frame

Cast-steel components are used in critical areas of the main frame where loads and stress is most concentrated.



Parts colored with yellow show cast-steel components.

Robust Dump Body Design

The standard dump body is made of high-tensile strength steel for excellent rigidity and low maintenance cost. Major portions of the interior surface are made of abrasion resistant, HB400 steel for excellent wear characteristics. The V-bottom design contributes to the structural strength and enhanced machine stability by centering the load at a lower center of balance. The side and bottom plates of the dump body are reinforced with lateral and longitudinal bolsters.

The standard body is non heated. A body heat conversion kit and a steel liner package are available as options.



Payload Policy

Purpose

Recognizing that variation occurs naturally in material density, fill factors, and loading equipment, Komatsu America Corp. deems it necessary to establish a consistent payload policy. This payload policy is intended to identify the guidelines and limitations for the loading of Komatsu mining trucks. Following this policy will provide the best combination of productivity and machine longevity.

Criteria

- 1) The average monthly payload must not exceed the rated payload of the truck.
- 2) 90% of all loads must be below 110% of the rated payload of the truck.
- 3) 10% of all loads may be between 110% and 120% of the rated payload of the truck.
- 4) No single payload may exceed 120% of the rated payload of the truck.

Rated payload: Rated gross vehicle weight - Empty vehicle weight (including any modifications such as bed liners, sideboards, tailgates, etc.)
(Include all attached options)

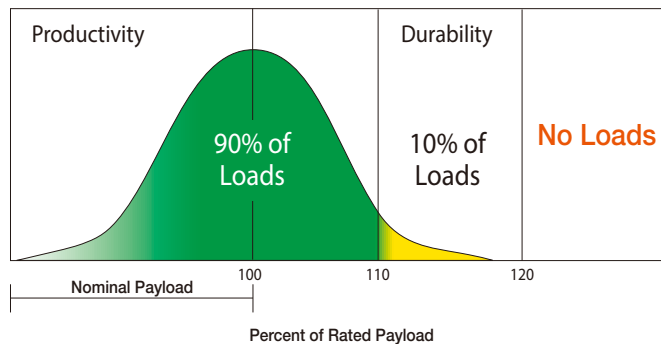

Integrated Payload Meter (PLM)

PLM is a tool to manage the payload of each hauling cycle and to analyze the production volume and the working conditions of the dump truck for a specified period of time. Loaded weight is indicated on the payload display (on the LCD monitor) and by the external display lamps in real time while loading. Daily and monthly total payload, dump count, average payload, and overload count can be viewed via KOMTRAX. Cycle by cycle data is available via download at the machine or via wireless LAN.

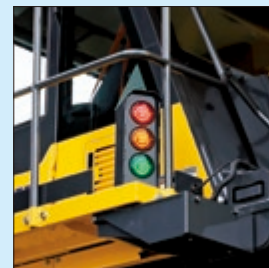

External display lamp

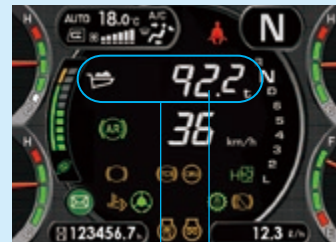

Payload display Loaded weight

MAINTENANCE FEATURES

Grouped Filters

Filters are grouped for easy service.

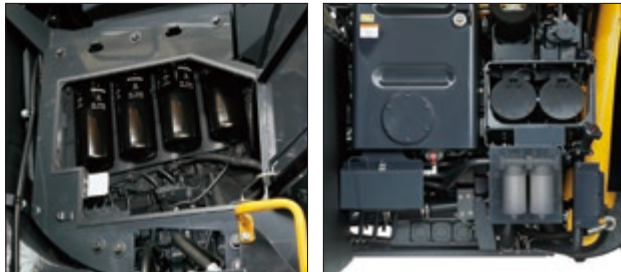

Hydraulic oil return filter

Brake cooling oil filter

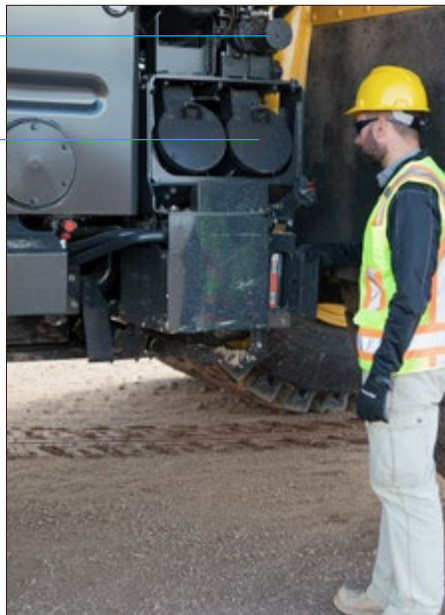

Electric Circuit Breaker

Circuit breakers are used for important electric circuits that need to be restored quickly if a problem occurs in the electrical system.



Centralized Greasing Points

Grease points are centralized at three locations.



Electric Priming Pump

Electric engine priming pump is standard.



Ground Level Service Center

A ground level service center is located at the bottom of the steering / hoist tank. Engine oil, transmission / brake cooling oil, brake control oil, and steering / hoist oil filling ports are accessible in one location for quick preventative maintenance servicing.

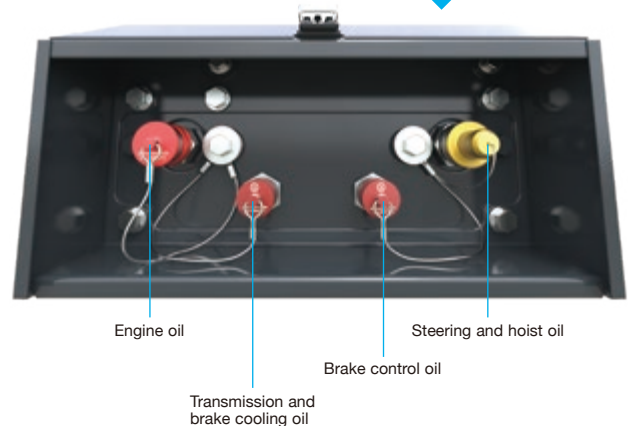

Battery / Starter Isolators, Machine Immobilization Switch, and Emergency Engine Stop Switch

Lockable battery and starter isolators are accessible from the ground level at the bottom of the diagonal stairway. A machine immobilization switch allows the engine to run, but disables steering / hoist operation and prevents the parking brake from being released. The emergency engine stop switch can be used to shutdown the engine in an emergency situation.

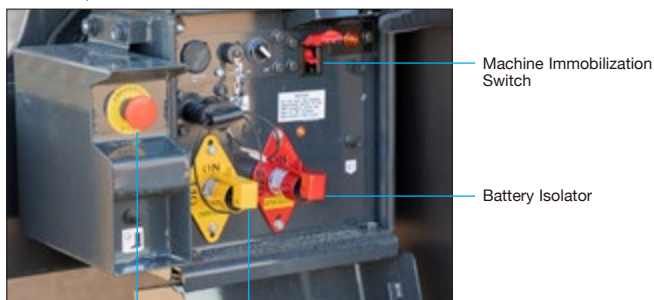

Emergency Engine Stop Switch Starter Isolator

Reversible Fan

The radiator fan is hydraulically driven and reversible. The fan reverse mode can be controlled from the monitor.

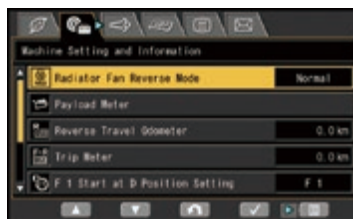

Fan reverse indicator

Modular Radiator Core System

The radiator assembly consists of five lead-free aluminum cores that can be independently replaced without removing the entire assembly.

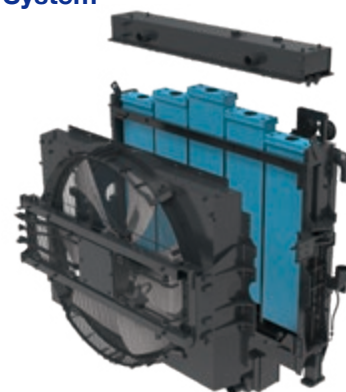

Wheel Chocks

Light weight resin wheel chocks are standard equipment and accessible from ground level underneath the diagonal stairway.



Extended Oil Change Intervals

Long oil change intervals minimize operating cost.

- Engine oil 500 hours
- Hydraulic oil 4,000 hours
- Transmission oil 1,000 hours



KOMTRAX EQUIPMENT MONITORING

GET THE WHOLE STORY WITH
KOMTRAX[®]

✓ WHAT

- KOMTRAX is Komatsu's remote equipment monitoring and management system
- KOMTRAX **continuously monitors and records** machine health and operational data
- Information such as fuel consumption, utilization, and a detailed history **lowering owning and operating cost**

✓ WHEN

- Know when your machines are **running or idling** and make decisions that will improve your fleet utilization
- Detailed movement records ensure you know when and where your equipment is moved
- Up to date records allow you to **know when maintenance is due** and help you plan for future maintenance needs

✓ WHERE

- KOMTRAX data **can be accessed virtually anywhere** through your computer, the web or your smart phone
- Automatic alerts keep fleet managers up to date on the latest machine notifications

✓ WHY

- Knowledge is power - **make informed decisions** to manage your fleet better
- Knowing your idle time and fuel consumption will help maximize your machine efficiency
- **Take control of your equipment** - any time, anywhere



✓ WHO

- KOMTRAX is **standard** equipment on all Komatsu construction products



KOMTRAX Plus[®]

Assists Customer's Equipment Management and Contributes to Fuel Cost Cutting

Equipment Management Support

KOMTRAX Plus enables expanded monitoring of the fleet via satellite and wireless LAN. Users can analyze "machine health" and performance from a remote location, on a near-real time basis. This includes component condition and trend data. By making this critical information readily accessible, KOMTRAX Plus is an effective tool in maximizing productivity and lowering operating costs.

SPECIFICATIONS



ENGINE

Model.....	Komatsu SAA12V140E-7*
Type.....	Water-cooled, four-cycle
Aspiration.....	Turbo-charged, after-cooled, cooled EGR
Number of cylinders.....	12
Bore.....	140 mm 5.51"
Stroke.....	165 mm 6.50"
Piston displacement.....	30.48 ltr 1,860 in³
Horsepower:	
SAE J1995.....	Gross 895 kW 1,200 HP
ISO 9249 / SAE J1349.....	Net 849 kW 1,140 HP
Rated rpm.....	1900 rpm
Fan drive type.....	Hydraulic
Maximum net torque.....	517 kg•m 3,739 ft lbs
Fuel system.....	Direct injection
Governor.....	Electronically controlled
Lubrication system:	
Method.....	Gear pump, force-lubrication
Filter.....	Full-flow type
Air cleaner.....	Dry type with double elements, precleaner and evacuator valve

*EPA Tier 4 Final emissions certified



TRANSMISSION

Torque converter.....	Three-elements, one-stage, two-phase
Transmission.....	Full-automatic, planetary type
Speed range.....	Seven speeds forward and two reverse
Lockup clutch.....	Wet, multiple-disc clutch
Forward.....	Torque converter drive in 1st gear, direct drive in 1st lockup and all higher gears
Reverse.....	Torque converter drive and direct (lockup)
Shift control.....	Electronic shift control with automatic clutch modulation in all gears
Maximum travel speed.....	65.0 km/h 40.4 mph



AXLES

Rear axle.....	Full-floating
Final drive type.....	Planetary gear
Ratios:	
Differential.....	2.944
Planetary.....	7.235



SUSPENSION SYSTEM

McPherson strut type front suspension and four-link type rear axle suspension with independent, hydropneumatic cylinders.	
Effective cylinder stroke	
Front suspension.....	320 mm 1' 0.6"
Rear suspension.....	127 mm 5"
Rear axle oscillation:	
Oil stopper.....	5.3°
Mechanical stopper.....	6.0°



STEERING SYSTEM

Type.....	Fully hydraulic power steering with two double-acting cylinders
Secondary steering.....	Automatic/Manual control (Meets ISO 5010 and SAE J1511)
Minimum turning radius.....	10.1 m 33' 2"
Maximum steering angle.....	41°



CAB

Standard.....	FOPS (ISO 3449 level II), ROPS (ISO 3471)
---------------	---



BRAKES

Brakes meet ISO 3450 standards.	
Service brakes:	
Front.....	Fully hydraulic control, oil-cooled multiple-disc type
Rear.....	Fully hydraulic control, oil-cooled multiple-disc type
Parking brake.....	Spring applied, multiple-disc type
Retarder.....	Oil-cooled, multiple-disc front and rear brakes act as retarder
Secondary brake.....	Manual pedal operation when hydraulic pressure drops below the rated level, parking brake is automatically actuated
Brake surface:	
Front.....	39195 cm ² 6,075 in²
Rear.....	71858 cm ² 11,138 in²



MAIN FRAME

Type.....	Box-sectioned structure
-----------	-------------------------



BODY

Capacity:	
Struck.....	40.0 m ³ 52.3 yd³
Heaped (2:1 SAE).....	60.0 m ³ 78.5 yd³
Rated payload.....	92.2 metric tons 101.6 U.S. tons
Material.....	400 brinell hardness high tensile strength steel
Structure.....	V-shape body with V-bottom
Material thickness:	
Bottom.....	19 mm 0.75"
Front.....	12 mm 0.47"
Sides.....	9 mm 0.35"
Target area	
(inside length x width).....	7070 mm x 5150 mm 23' 2" x 16' 11"
Height at full dump.....	10080 mm 33' 1"
Heating.....	Exhaust heating



HYDRAULIC SYSTEM

Hoist cylinder.....	Twin, two-stage telescopic type
Relief pressure.....	20.6 MPa 210 kg/cm ² 2,990 psi
Hoist time:	
Raise.....	11.5 sec
Lower.....	14.0 sec



WEIGHT (APPROXIMATE)

Rated empty vehicle weight.....	73800 kg 162,701 lbs
Rated gross vehicle weight.....	166000 kg 365,967 lbs
Weight distribution:	
Empty:	
Front axle.....	51.5%
Rear axle.....	48.5%
Loaded:	
Front axle.....	33.2%
Rear axle.....	66.8%



TIRES

Standard tire.....	27.00 R49
--------------------	-----------



SERVICE REFILL CAPACITIES

Fuel tank.....	1322 ltr 349.2 U.S. gal
Engine oil.....	138 ltr 36.5 U.S. gal
Torque converter, transmission and retarder cooling.....	530 ltr 140.0 U.S. gal
Differential.....	203 ltr 59.6 U.S. gal
Final drives (total).....	116 ltr 30.6 U.S. gal
Hydraulic system.....	385 ltr 101.7 U.S. gal
Suspension (total).....	92.6 ltr 24.5 U.S. gal

SPECIFICATIONS



DIMENSIONS

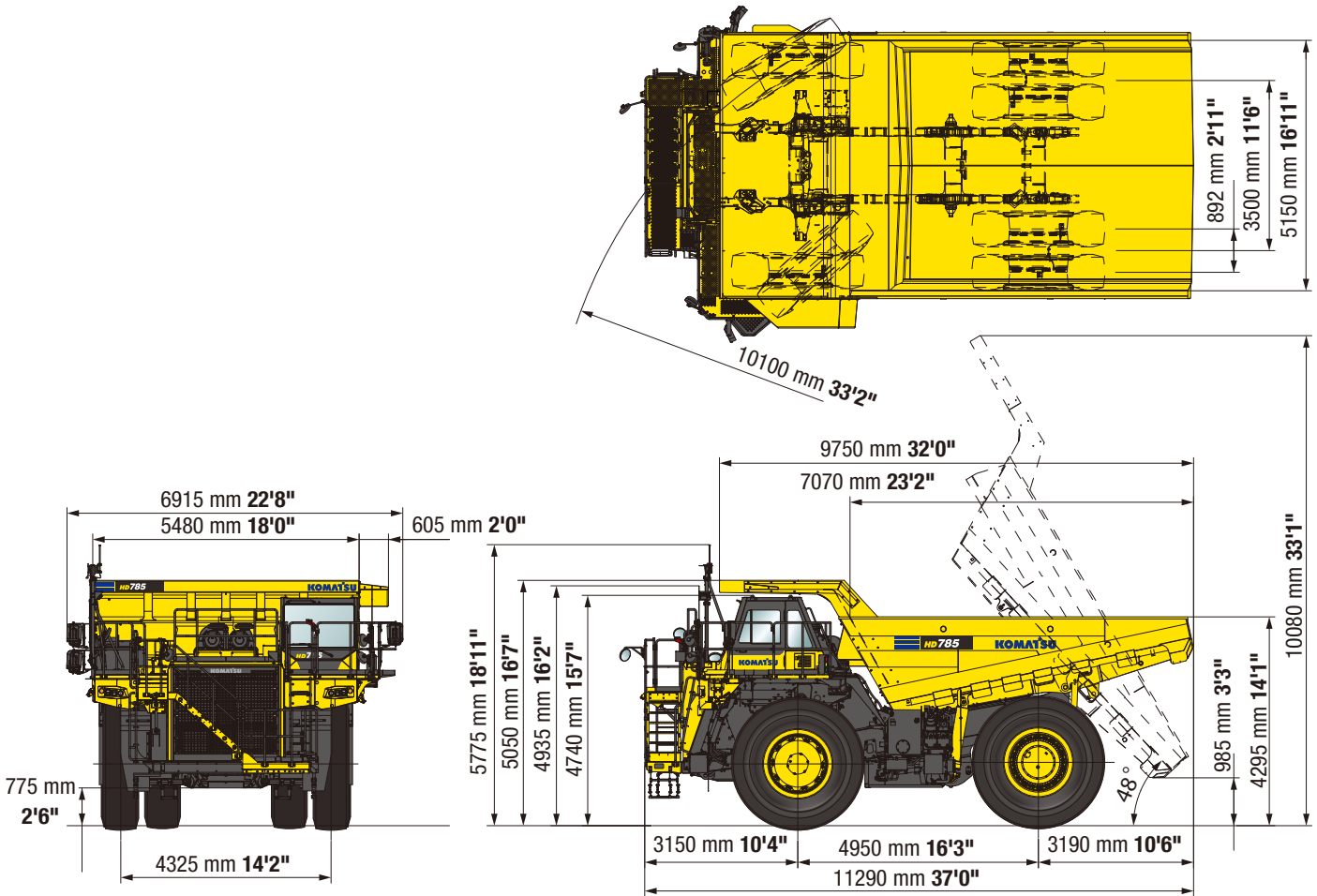

TRAVEL PERFORMANCE

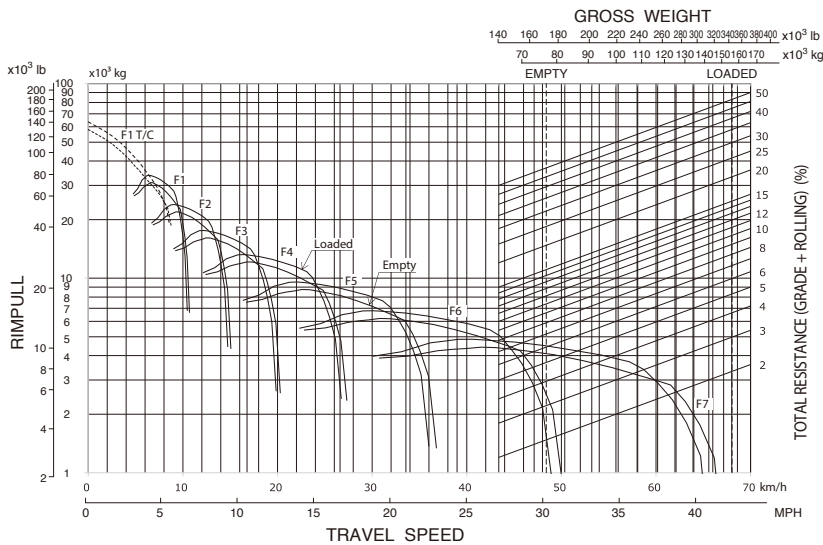

BRAKE PERFORMANCE

GRADE DISTANCE:
CONTINUOUS DESCENT

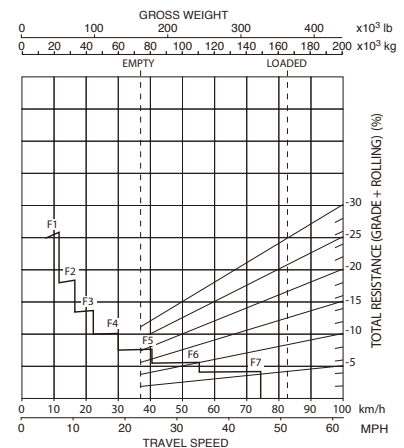

At ambient temperature 40°C
Retarder performance varies depending on ambient temperature.



STANDARD EQUIPMENT FOR BASE MACHINE

ENGINE AND RELATED COMPONENTS

- Air cleaner, double element with restriction indicator (qty 2)
- Auto Idle Shutdown
- Automatic Idling Setting System (AISS)
- Electric priming fuel pump
- Engine, KOMATSU SAA12V140E-7, 12 cylinder, turbocharged, after cooled, EGR cooled, diesel
Gross HP: **1200 HP** (895 kW) / 1900 RPM (SAE J1995)
Net HP: **1140 HP** (849 kW) / 1900 RPM (ISO 9249 / SAE J1349)
- Engine pre-lubrication system
- Engine secondary shutdown switch
- Fan, hydraulically driven, reversible
- Komatsu diesel particulate filter (KDPF) (qty 2)
- Radiator, lead free, modular core

ELECTRICAL SYSTEM

- Alternator, 140 amp, 24 volt
- Back-up alarm
- Batteries, 4 x 12V
- Battery isolator
- Electric circuit breakers, 24V
- Emergency stop switch, ground level
- Horn, electric
- Lights
- Access ladder lamps
- Back-up Lamps, rear
- Engine compartment lamp
- Fog lamps
- Head lamps, high and low beam, LED
- Side working lamps, LH & RH, LED
- Stop and tail Lamps, LED
- Turn signals, hazard warning, front & rear, LED
- Starter isolator
- Starting motors, 2 x 11.0 kW, electric

POWER TRAIN AND CONTROLS

- 7-speed transmission, fully automatic, (7F, 2R)
- Brake cooling oil recovery tank
- Brakes, oil cooled, wet multiple-disc, hydraulically controlled, front & rear
- Komatsu Traction Control System (KTCS)

- Neutral coast inhibitor
- Parking brake, integrated in front & rear brakes
- Retarder, automatic & manual
- Secondary brake, pedal actuated, variable
- Skip shift function
- Speed limiter
- Torque converter with electronic lockup control

OPERATOR ENVIRONMENT

- Cab with built-in ROPS/FOPS (ISO 3471/ISO 3449)
- 12V outlet (qty 2)
- Automatic climate control system with cab pressurization
- Body hoist control, electric
- Cigarette lighter and ashtray
- Cup holder
- Door, LH & RH
- KomVision camera system with dedicated monitor
- Machine monitor with 7" color LCD display
- Mode selection system with Variable Horsepower Control
- Operator seat, air suspension, heated, ventilated with 3-point 3" retractable seat belt
- Power windows, LH & RH
- Radio, AM/FM with aux input, USB, & bluetooth
- Rearview mirror, outside cab mount, heated (qty 2)
- Rearview monitoring system with dedicated monitor
- Secondary steering, automatic & manual
- Steering wheel, tilt and telescopic
- Sunvisor (qty 2)
- Tinted glass with electric defogger
- Trainer seat with 3" retractable lap belt
- Underview mirror
- Wiper/washer, windshield (intermittent)
- Diagonal access stairway

GUARD AND COVER GROUP

- Cab & platform guard
- Catwalk with handrails, skid resistant
- Driveline guards, front & rear
- Engine side covers
- Engine underguard
- Exhaust thermal guard
- Fire safety shield (located behind engine)
- Mud flaps
- Rock ejector bars
- Transmission underguard

OTHER STANDARD EQUIPMENT

- Anchor points, tie off type (ISO 14567)
- Automatic Retard Speed Control (ARSC)
- Cold weather package (electric heaters for engine oil & coolant heater)
- Dump counter
- Ecology guidance and ecology gauge
- Engine oil & coolant heater, electric
- Fast fill coupler for fuel tank
- Filler cap lock & cover lock
- Ground level service center
 - Centralized KOWA sampling
 - Fluids ports
- Transmission, engine, brake control, steering and hoist oil
- Hydropneumatic Suspension, Front & Rear
- Jump start receptacle
- KOMTRAX Plus®
- Machine immobilization switch
- Overload prevention system
- Overrun warning and prevention
- Overturn warning system
- Payload meter
- PM service connectors
- Rims for 27.00 R49 tires with large bore valve stems (qty 6)
- Safety pins (qty 2)
- Wheel chocks (qty 2)



OPTIONAL EQUIPMENT

BODY

- Dump body, 78.5 yd³
- Steel liners for rock body (78.5 yd³)
- Body heating kit

TIRES

- Michelin XDR2B (qty 6)
- Bridgestone VMTP (qty 6)

OTHERS

- Power boarding ladder

HD785-8



EN-HD785-8BR01-0622-V5 ©2022 Komatsu America Corp.

AD06/22(POD)

06/22 (EV-1)

KOMATSU[®]

Note: All comparisons and claims of improved performance made herein are made with respect to the prior Komatsu model unless otherwise specifically stated.

www.komatsuamerica.com

Komatsu America Corp. is an authorized licensee of Komatsu Ltd.

Materials and specifications are subject to change without notice

KOMATSU[®], Komatsu Care[®], KOMTRAX[®], KOMTRAX Plus[®] and KomVision[®] are registered trademarks of Komatsu Ltd.

All other trademarks and service marks used herein are the property of Komatsu Ltd., Komatsu America Corp. or their respective owners or licensees.