



**POWER EQUIPMENT**  
PRESSURE WASHERS AND GENERATORS







## HUSTLER® - THE BRAND YOU CAN RELY ON

Across the globe, the Hustler brand signifies innovation, strength, performance, and superior customer care resulting in unmatched customer loyalty. Our mission is to provide the most dependable, useful, and time-saving products in outdoor maintenance.

# POWER EQUIPMENT

## OVERVIEW

### PRESSURE WASHERS

### INVERTER GENERATORS

### GENERATORS

HH3324

HH3535

HH3725

HH4035

HH4240

HH4440

HH4400

HIG2200

HIG3632E

HIG4540E

HPGH5500

HPGH8500

HPGH8500E

## PRESSURE WASHERS

Hustler Turf pressure washers are strong and durable machines with HONDA® power. With an ultra-lightweight aircraft-grade aluminum frame, they are easy to maneuver and transport. Hustler pressure washers come with a best-in-class warranty providing you peace of mind.



## HH3324

- ✓ 3300 PSI @ 2.4 GPM
- ✓ Easy to use
- ✓ Compact design
- ✓ Lightweight and small enough for one person to easily transport
- ✓ Great for cleaning decks, patios, siding, outdoor furniture and prepping home exteriors for painting



SPECIFICATIONS	
<b>ENGINE</b> HONDA® GC190	<b>PUMP</b> OEM TECHNOLOGIES™ CAM PUMP
<b>PSI</b> 3300	<b>GPM</b> 2.4
<b>HOSE</b> MORFLEX™ 1/4" x 25'	<b>NOZZLES</b> 0°, 15°, 25°, 40°, SOAP



Restrictions apply. See your Authorized Hustler Dealer for warranty details.

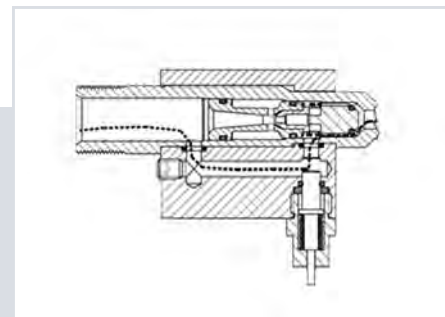

**Innovative Pump Design**  
Equipped with a maintenance-free OEM Technologies™ axial cam pump.



**Strength & Flexibility**  
MorFlex™ hose with a polyurethane jacket is up to three times more abrasive-resistant than rubber while remaining lightweight and kink-resistant.



**Ergonomic Side-Assist Spray Gun**  
Professional-style spray gun with ergonomic 360° rotating handle.

## HH3535

- ✓ 3500 PSI @ 2.5 GPM
- ✓ Powerful CRX® engine
- ✓ Commercial axial pump
- ✓ Powder coated steel frame
- ✓ Ensures professional-grade cleaning for your fleet and facility maintenance



SPECIFICATIONS	
<b>ENGINE</b> CRX208	<b>PUMP</b> AAA™ AX300 COMMERCIAL AXIAL CAM PUMP
<b>PSI</b> 3500	<b>GPM</b> 2.5
<b>HOSE</b> MORFLEX™ 5/16" x 25'	<b>NOZZLES</b> 0°, 15°, 25°, 40°, SOAP AND TURBO



Restrictions apply. See your Authorized Hustler Dealer for warranty details.



**Innovative Pump Design**  
Highly efficient, while minimizing engine load and delivering top performance. Equipped with stainless steel pistons for improved seal life, high performance double high pressure seals, and a brass head with an integrated adjustable unloader.



**Strength & Flexibility**  
MorFlex™ hose with a polyurethane jacket is up to three times more abrasive-resistant than rubber while remaining lightweight and kink-resistant.



**Ergonomic Side-Assist Spray Gun**  
Professional-style spray gun with ergonomic 360° rotating handle.



## HH3725

- ✓ 3700 PSI @ 2.5 GPM
- ✓ Powerful Honda® engine
- ✓ Reliable triplex pump
- ✓ Ultra-lightweight aircraft-grade aluminum frame
- ✓ Ensures professional-grade cleaning for your fleet and facility maintenance



SPECIFICATIONS	
<b>ENGINE</b> HONDA® GX200	<b>PUMP</b> AAA™ INDUSTRIAL TRIPLEX PUMP
<b>PSI</b> 3700	<b>GPM</b> 2.5
<b>HOSE</b> MONSTER™ STEEL-BRAIDED 3/8" x 50'	<b>NOZZLES</b> 0°, 15°, 25°, 40°, SOAP AND TURBO

COMMERCIAL  
**10**  
YEAR  
LIMITED  
FRAME  
WARRANTY

COMMERCIAL  
**3**  
YEAR  
LIMITED  
ENGINE  
WARRANTY

COMMERCIAL  
**5**  
YEAR  
LIMITED  
PUMP  
WARRANTY

Restrictions apply. See your Authorized Hustler Dealer for warranty details.



**Innovative Pump Design**  
External unloader with external bypass for fast and easy maintenance as well as increased pump protection.



**Strength & Flexibility**  
Dual-braided MONSTER Hose™. Polyurethane outer jacket. Non-marring. Three times more abrasion-resistant than rubber hose.



**Maximum Cleaning**  
Turbo nozzle delivers a faster and deeper clean with a powerful oscillating jet.

## HH4035

- ✓ 4000 PSI @ 3.5 GPM
- ✓ Powerful Honda® engine
- ✓ Reliable triplex pump
- ✓ Ultra-lightweight aircraft-grade aluminum frame
- ✓ Provides a pro-clean for oversized jobs



SPECIFICATIONS	
<b>ENGINE</b> HONDA® GX270	<b>PUMP</b> AAA™ INDUSTRIAL TRIPLEX PUMP
<b>PSI</b> 4000	<b>GPM</b> 3.5
<b>HOSE</b> MONSTER™ STEEL-BRAIDED 3/8" x 50'	<b>NOZZLES</b> 0°, 15°, 25°, 40°, SOAP AND TURBO

COMMERCIAL  
**10**  
YEAR  
LIMITED  
FRAME  
WARRANTY

COMMERCIAL  
**3**  
YEAR  
LIMITED  
ENGINE  
WARRANTY

COMMERCIAL  
**5**  
YEAR  
LIMITED  
PUMP  
WARRANTY

Restrictions apply. See your Authorized Hustler Dealer for warranty details.



**Innovative Pump Design**  
External unloader with external bypass for fast and easy maintenance as well as increased pump protection.

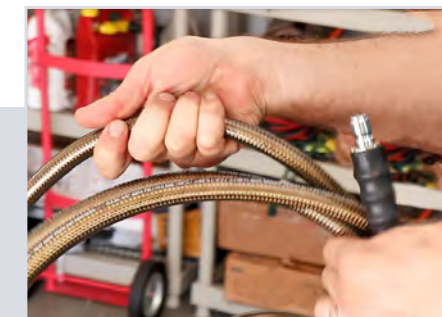

**Strength & Flexibility**  
Dual-braided MONSTER Hose™. Polyurethane outer jacket. Non-marring. Three times more abrasion-resistant than rubber hose.



**Maximum Cleaning**  
Turbo nozzle delivers a faster and deeper clean with a powerful oscillating jet.

# HH4240

- ✓ 4200 PSI @ 4.0 GPM
- ✓ Belt-driven
- ✓ Built for long continuous running hours
- ✓ Perfect for facility, fleet, and property jobs that require extended cleaning times



SPECIFICATIONS	
<b>ENGINE</b> HONDA® GX390	<b>PUMP</b> AAA™ INDUSTRIAL TRIPLEX PUMP
<b>PSI</b> 4200	<b>GPM</b> 4.0
<b>HOSE</b> MONSTER™ STEEL-BRAIDED 3/8" x 50'	<b>NOZZLES</b> 0°, 15°, 25°, 40°, SOAP AND TURBO



Restrictions apply. See your Authorized Hustler Dealer for warranty details.



**Innovative Pump Design**  
External unloader with external bypass for fast and easy maintenance as well as increased pump protection.



**Strength & Flexibility**  
Dual-braided MONSTER Hose™. Polyurethane outer jacket. Non-marring. Three times more abrasion-resistant than rubber hose.



**Maximum Cleaning**  
Turbo nozzle delivers a faster and deeper clean with a powerful oscillating jet.

# HH4440

- ✓ 4400 PSI @ 4.0 GPM
- ✓ Powerful Honda® engine
- ✓ Reliable triplex pump
- ✓ Ultra-lightweight aircraft-grade aluminum frame
- ✓ Built to perform in a wide range of commercial cleaning applications



SPECIFICATIONS	
<b>ENGINE</b> HONDA® GX390	<b>PUMP</b> AAA™ INDUSTRIAL TRIPLEX PUMP
<b>PSI</b> 4400	<b>GPM</b> 4.0
<b>HOSE</b> MONSTER™ STEEL-BRAIDED 3/8" x 50'	<b>NOZZLES</b> 0°, 15°, 25°, 40°, SOAP AND TURBO



Restrictions apply. See your Authorized Hustler Dealer for warranty details.



**Innovative Pump Design**  
External unloader with external bypass for fast and easy maintenance as well as increased pump protection.

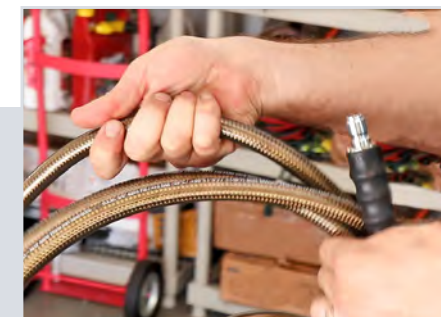

**Strength & Flexibility**  
Dual-braided MONSTER Hose™. Polyurethane outer jacket. Non-marring. Three times more abrasion-resistant than rubber hose.



**Maximum Cleaning**  
Turbo nozzle delivers a faster and deeper clean with a powerful oscillating jet.



# PRESSURE WASHERS COMPARISON

## HH4400

- ✓ 4400 PSI @ 4.0 GPM
- ✓ Powerful CRX engine
- ✓ Reliable triplex pump
- ✓ Ultra-lightweight aircraft-grade aluminum frame
- ✓ Built to perform in a wide range of commercial cleaning applications



SPECIFICATIONS	
<b>ENGINE</b> CRX420	<b>PUMP</b> AAA™ INDUSTRIAL TRIPLEX PUMP
<b>PSI</b> 4400	<b>GPM</b> 4.0
<b>HOSE</b> MONSTER™ STEEL-BRAIDED 3/8" x 50'	<b>NOZZLES</b> 0°, 15°, 25°, 40°, SOAP AND TURBO



Restrictions apply. See your Authorized Hustler Dealer for warranty details.



**Innovative Pump Design**  
External unloader with external bypass for fast and easy maintenance as well as increased pump protection.



**Strength & Flexibility**  
Dual-braided MONSTER Hose™. Polyurethane outer jacket. Non-marring. Three times more abrasion-resistant than rubber hose.



**Maximum Cleaning**  
Turbo nozzle delivers a faster and deeper clean with a powerful oscillating jet.



	HH3324	HH3535	HH3725
<b>ENGINE</b>	Honda® GC190	CRX208	Honda® GX270
<b>PSI</b>	3300	3500	3700
<b>GPM</b>	2.4	2.5	2.5
<b>HOSE</b>	MorFlex™ 1/4" x 25'	MorFlex™ 5/16" x 25'	Monster Hose™ Steel-Braided 3/8" x 50'
<b>PUMP</b>	OEM Technologies Axial Cam Pump	AAA AX300 Commercial Axial Cam Pump	AAA Industrial Triplex Pump
<b>NOZZLES</b>	0°, 15°, 25°, 40°, Soap	0°, 15°, 25°, 40°, Soap and Turbo	0°, 15°, 25°, 40°, Soap and Turbo



	HH4035	HH4240	HH4400	HH4440
<b>ENGINE</b>	Honda® GX270	Honda® GX390	Honda® GX390	CRX420
<b>PSI</b>	4000	4200	4400	4400
<b>GPM</b>	3.5	4.0	4.0	4.0
<b>HOSE</b>	Monster Hose™ Steel-Braided 3/8" x 50'			
<b>PUMP</b>	AAA Industrial Triplex Pump			
<b>NOZZLES</b>	0°, 15°, 25°, 40°, Soap and Turbo			

Specifications are subject to change without notice.

# PRESSURE WASHER ACCESSORIES

## HOSES

### MONSTER HOSE™



LENGTH	MAX PSI	TEMP	ID	FITTING
50"	4500	140° F	3/8"	3/8" QC
100"	4500	140° F	3/8"	3/8" QC



#### STRENGTH & FLEXIBILITY

Dual-braided MONSTER Hose™. Polyurethane outer jacket. Non-marring. Three times more abrasion-resistant than rubber hose.

### MORFLEX™ HOSE



LENGTH	MAX PSI	TEMP	ID	FITTING
50"	3700	140° F	5/16"	M22*



#### LIGHTWEIGHT & FLEXIBLE

MorFlex™ Hose with a polyurethane jacket is up to three times more abrasion-resistant than rubber while remaining lightweight and kink-resistant.

\* Includes hose adapter for connecting multiple hoses

## GUNS

### SPRAY GUN



DESCRIPTION	MAX PSI	MAX TEMP
SPRAY GUN WITH ERGONOMIC GRIP	4500	140° F

- ✓ Pro-style ergonomic design with side-assist grip and easy pull trigger for comfort and ease of use
- ✓ Includes a 3/8" quick-connect plug adapter so gun can connect to MONSTER and/or MorFlex hoses

### PRO GUN HANDLE



DESCRIPTION	MAX PSI	MAX TEMP
SPRAY GUN WITH ERGONOMIC GRIP	5000	212° F

- ✓ Hot and cold water application capable
- ✓ Pro-style ergonomic design and easy pull trigger for comfort and ease of use
- ✓ Includes adapters so gun can connect to MONSTER and/or MorFlex hoses

## NOZZLES

### TURBO NOZZLES



DESCRIPTION	MAX PSI	TEMP	ID
OSCILLATING TURBO NOZZLE	3600	3.0	140° F
OSCILLATING TURBO NOZZLE	4500	4.0	140° F

- ✓ Creates a powerful jet of oscillating water
- ✓ Cleaning impact of a 0° nozzle

### NOZZLE SETS

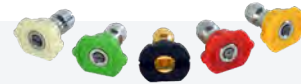

DESCRIPTION	MAX PSI	ORIFICE SIZE	MAX TEMP
SET OF FIVE SPRAY NOZZLES 0°, 15°, 25°, 40° AND SOAP	3600	3.0	140° F
SET OF FIVE SPRAY NOZZLES 0°, 15°, 25°, 40° AND SOAP	4500	4.0	140° F

- ✓ Universal to fit pressure washers with quick-connect spray wands
- ✓ Array of spray patterns from pin-point for tough jobs, to wide-fan for maximum coverage

## LANCES

### SPRAY LANCE



DESCRIPTION	MAX PSI	MAX TEMP
16" SPRAY LANCE	3600	140° F
31" SPRAY LANCE	4500	140° F

- ✓ 1/4" quick-connect for easy attachment of spray tips and other accessories
- ✓ Cold-water applications only

### INSULATED LANCE



DESCRIPTION	MAX PSI	MAX TEMP
48" INSULATED LANCE	5000	212° F

- ✓ 1/4" quick-connect for easy attachment of spray tips and other accessories
- ✓ Insulated for hot-water applications

## SCRUBBERS

### SURFACE SCRUBBER



DESCRIPTION	MAX PSI	DIAMETER
SURFACE SCRUBBER	3600	15"

- ✓ Cleans large surfaces including garage floors, driveways, patios, and decks quickly and uniformly
- ✓ High-quality assembly includes powder-coated steel shroud and stainless steel nozzles
- ✓ Two high-pressure nozzles for quick streak-free cleaning

### SURFACE SCRUBBER

DESCRIPTION	MAX PSI	DIAMETER
SURFACE SCRUBBER	4500	20"

- ✓ Equipped with in-line filter to prevent nozzle obstruction and pump damage
- ✓ Two high-pressure stainless steel nozzles for quick streak-free cleaning



# INVERTERS & GENERATORS

## INVERTERS & GENERATORS

Hustler® Turf portable generators and inverters are engineered to perform and built to last. Perfect for providing power at worksites, recreational facilities, residential locations, and more. Whether tailgating before a game, charging tools at a construction site, or providing backup power for your home, Hustler gets the job done.



## HIG2200

- ✓ LED warning lights for low oil & power overload
- ✓ 8-hour run time at 50% load
- ✓ Sound pressure level: 53 dB(A) at 23 feet



SPECIFICATIONS	
<b>ENGINE</b> HUSTLER®	<b>ENGINE CC</b> 79cc
<b>STARTING WATTS</b> 2200	<b>FUEL TANK CAPACITY</b> 1.2 GAL

COMMERCIAL  
**1 YEAR** LIMITED ENGINE WARRANTY

**3 YEAR** LIMITED WARRANTY CONSUMER

**180 DAY** LIMITED WARRANTY COMMERCIAL

Restrictions apply. See your Authorized Hustler Dealer for warranty details.

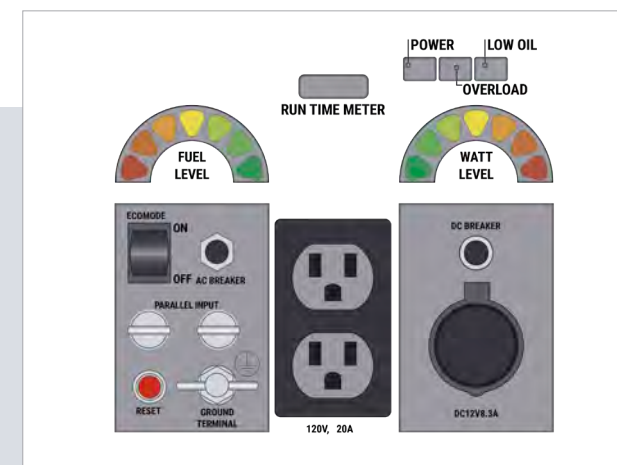

Parallel Kit  
(inverter accessory)



## HIG3632E

- ✓ LED warning lights for low oil & power overload
- ✓ 8-hour run time at 50% load
- ✓ Sound pressure level: 70 dB(A) at 23 feet



SPECIFICATIONS	
<b>ENGINE</b> HUSTLER®	<b>ENGINE CC</b> 212cc
<b>STARTING WATTS</b> 3600	<b>FUEL TANK CAPACITY</b> 1.5 GAL

COMMERCIAL  
**1 YEAR LIMITED ENGINE WARRANTY**

**3 YEAR LIMITED WARRANTY CONSUMER**

**180 DAY LIMITED WARRANTY COMMERCIAL**

Restrictions apply. See your Authorized Hustler Dealer for warranty details.



Parallel Kit  
(inverter accessory)

## HIG4540E

- ✓ LED warning lights for low oil & power overload
- ✓ 8-hour run time at 50% load
- ✓ Sound pressure level: 72 dB(A) at 23 feet



SPECIFICATIONS	
<b>ENGINE</b> HUSTLER®	<b>ENGINE CC</b> 223cc
<b>STARTING WATTS</b> 4500	<b>FUEL TANK CAPACITY</b> 2.4 GAL

COMMERCIAL  
**1 YEAR LIMITED ENGINE WARRANTY**

**3 YEAR LIMITED WARRANTY CONSUMER**

**180 DAY LIMITED WARRANTY COMMERCIAL**

Restrictions apply. See your Authorized Hustler Dealer for warranty details.



Parallel Kit  
(inverter accessory)

# HPGH5500

- ✓ Low-oil engine shutdown protection
- ✓ Less than 5% harmonic distortion (THD) for safely running sensitive electronics
- ✓ GFCI protection
- ✓ Copper alternator windings
- ✓ Convenient fold-down handle for easy maneuverability & storage
- ✓ Durable never-flat tires
- ✓ Sound pressure level: 76 dB(A) at 23 feet



SPECIFICATIONS	
<b>ENGINE</b> HONDA® GX270	<b>ENGINE CC</b> 270cc
<b>STARTING WATTS</b> 5500	<b>FUEL TANK CAPACITY</b> 8 GAL

**3** YEAR LIMITED WARRANTY CONSUMER

**1** YEAR LIMITED WARRANTY COMMERCIAL

**3** YEAR LIMITED ENGINE WARRANTY + **2** YEAR LIMITED EXTENDED MANUFACTURER WARRANTY = **5** YEAR TOTAL ENGINE PROTECTION

Restrictions apply. See your Authorized Hustler Dealer for warranty details.

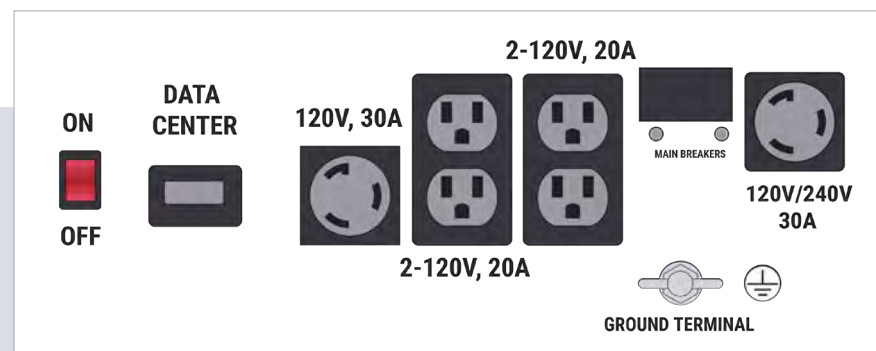

# HPGH8500

- ✓ Low-oil engine shutdown protection
- ✓ Less than 5% harmonic distortion (THD) for safely running sensitive electronics
- ✓ GFCI protection
- ✓ Convenient fold-down handle for easy maneuverability & storage
- ✓ Durable never-flat tires
- ✓ Copper alternator windings
- ✓ Sound pressure level: 80 dB(A) at 23 feet



SPECIFICATIONS	
<b>ENGINE</b> HONDA® GX390	<b>ENGINE CC</b> 389cc
<b>STARTING WATTS</b> 8500	<b>FUEL TANK CAPACITY</b> 8 GAL

**3** YEAR LIMITED WARRANTY CONSUMER

**1** YEAR LIMITED WARRANTY COMMERCIAL

**3** YEAR LIMITED ENGINE WARRANTY + **2** YEAR LIMITED EXTENDED MANUFACTURER WARRANTY = **5** YEAR TOTAL ENGINE PROTECTION

Restrictions apply. See your Authorized Hustler Dealer for warranty details.

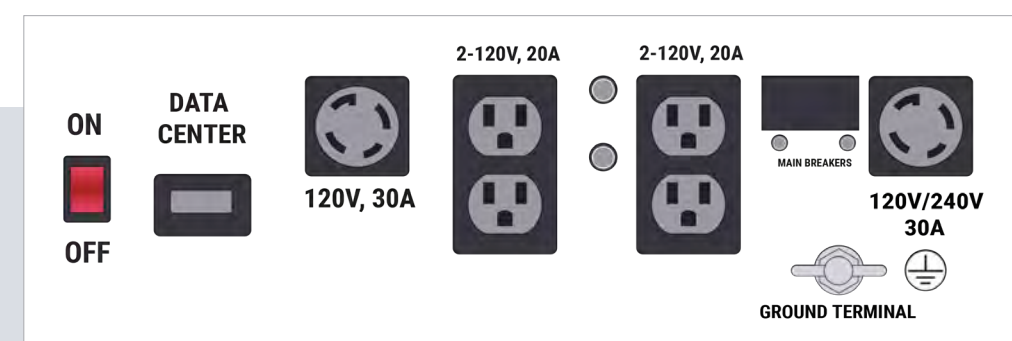



## HPGH8500E

- ✓ Electric start
- ✓ Low-oil engine shutdown protection
- ✓ Less than 5% harmonic distortion (THD) for safely running sensitive electronics
- ✓ GFCI protection
- ✓ Convenient fold-down handle for easy maneuverability & storage
- ✓ Durable never-flat tires
- ✓ Copper alternator windings
- ✓ Sound pressure level: 80 dB(A) at 23 feet



SPECIFICATIONS	
<b>ENGINE</b> HONDA® GX390	<b>ENGINE CC</b> 389cc
<b>STARTING WATTS</b> 8500	<b>FUEL TANK CAPACITY</b> 8 GAL



Restrictions apply. See your Authorized Hustler Dealer for warranty details.

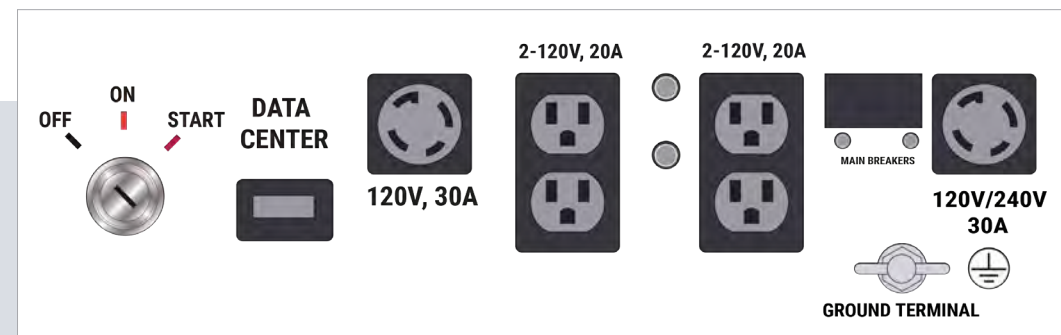

	HIG2200	HIG3632E	HIG4540E
<b>ENGINE</b>	Hustler®	Hustler®	Hustler®
<b>ENGINE CC</b>	79cc	212cc	223cc
<b>RUN TIME (50%)</b>	8 HRS	8 HRS	8 HRS
<b>RUNNING WATTS</b>	1800	3200	4000
<b>STARTING WATTS</b>	2200	3600	4500
<b>FUEL TANK CAPACITY</b>	1.2 GAL	1.5GAL	2.4GAL
<b>AUTO ENGINE SHUTOFF</b>	N	N	N
<b>ELECTRIC START</b>	N	Y	Y

# GENERATOR COMPARISON



	HPGH5500	HPGH8500	HPGH8500E
<b>ENGINE</b>	Honda® GX270	Honda® GX390	Honda® GX390
<b>ENGINE CC</b>	270cc	389cc	389cc
<b>RUN TIME (50%)</b>	-	-	-
<b>RUNNING WATTS</b>	4500	7500	7500
<b>STARTING WATTS</b>	5500	8500	8500
<b>FUEL TANK CAPACITY</b>	8 GAL	8 GAL	8 GAL
<b>AUTO ENGINE SHUTOFF</b>	Y	Y	Y
<b>ELECTRIC START</b>	N	N	Y

Specifications are subject to change without notice.

## HUSTLER FLUID PRODUCTS

Hustler Turf's motor oil, fuel stabilizer and hydrostatic transmission oil products will help keep your machine running smoothly. Ask your local dealer about availability of these products.



### TRANSMISSION OIL

- ✓ Guards against heat, sludge and harmful deposits
- ✓ Excellent hot and cold-weather performance
- ✓ Strong anti-wear protection
- ✓ Helps maintain tight pump and motor tolerances which keep the transmission operating efficiently



### FUEL STABILIZER

- ✓ Triple corrosion protection for longer lasting engine components
- ✓ Prevents gasoline oxidation for easier starts after storage or downtime
- ✓ Effective in all gasoline, including ethanol blends
- ✓ Powerful antioxidants to help prevent acids from forming



### ENGINE OIL

- ✓ Anti-wear additive package that protects engines from harmful wear
- ✓ Detergent/dispersant content maintains engine cleanliness
- ✓ Excellent hot and cold-temperature performance
- ✓ Multi-viscosity oil helps extend engine life and increase performance

Visit [hustlerturf.com/find-a-retailer](https://hustlerturf.com/find-a-retailer) to locate your nearest dealer.





**HUSTLER®**

©2022 HUSTLER TURF EQUIPMENT

SPECIFICATIONS SUBJECT TO CHANGE WITHOUT NOTICE.  
VISIT [HUSTLERTURF.COM](https://www.hustlerturf.com) FOR THE MOST CURRENT  
SPECIFICATIONS. 2-22

**[HUSTLERTURF.COM](https://www.hustlerturf.com)**