

PORTABLE INVERTER GENERATOR

i45 SERIES

Owner's Manual

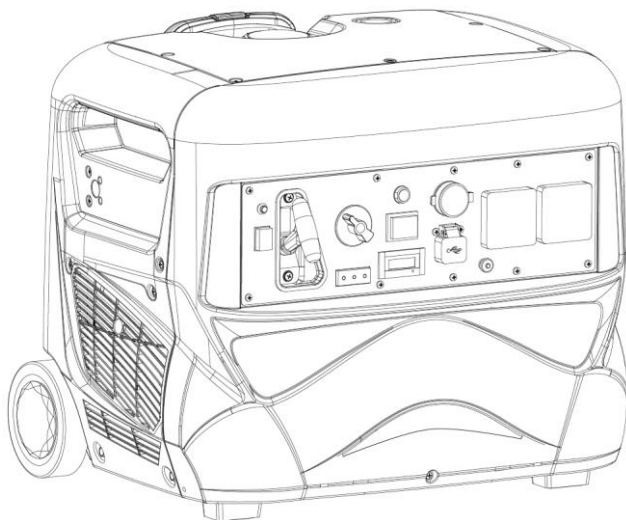

INTRODUCTION

Thank you for purchasing our products.

This manual provides you important information about operation and maintenance of the product.

If you have any question, regarding to the operation or maintenance of your product, please consult designated dealer.



Read this manual carefully before operating this product.

This manual must be together with the product once sold.

IMPORTANT MANUAL INFORMATION

Particularly important information is as below:



It is safety-warning symbol, which reminds you potential personal injury danger. Please follow all information in the symbol to avoid any possible injury or death.



WARNING: It indicates a dangerous situation, which will cause serious injury or death if not avoided.

NOTICE: It indicates special precaution to avoid any damage to this product or other property.

NOTE: It provides important information to simplify the operation.



WARNING:

Please read carefully and fully understand this manual before using the product, and operate it as per instruction.

NOTE:

Our company will continually seek innovation and update in product's design and quality, therefore, although this manual contains latest product information once printed, there may be minor discrepancies in actual product. If any question about this manual, please consult designated dealer.

INDEX

WARRANTY	4
IMPORTANT LABEL LOCATION	4
SYMBOL MEANING.....	7
SAFETY INFORMATION	8
POISONOUS EXHAUST.....	9
HIGHLY FLAMMABLE AND POISONOUS FUEL.....	9
NO TILT DURING OPERATION OR MOVING.....	9
HOT GENERATOR AND MUFFLER	10
ELECTRIC SHOCK PREVENTION.....	10
EXTENSION CABLE NOTE.....	11
CABLE CONNECTION NOTE.....	11
DESCRIPTION	12
CONTROL PANEL	13
CONTROL FUNCTION	14
MAIN SWITCH.....	14
ENGINE SWITCH.....	14
ENGINE START BUTTON.....	14
REMOTE CONTROL.....	14
ECO SWITCH.....	15
AC SOCKET.....	15
LOW OIL ALARM (YELLOW).....	16
OVERLOAD ALARM (RED) AND RESET BUTTON (RED).....	17
OUTPUT INDICATOR (GREEN)	17
PRE-OPERATION CHECK	17
FUEL	18
OIL.....	19
GROUND TERMINAL.....	20
MOBILE BATTERY.....	20
OPERATION	20
STARTING THE GENERATOR	20

APPLICATION RANGE.....	23
AC CONNECTION	24
DC CONNECTION.....	25
STOPPING THE GENERATOR	25
PERIODIC MAINTENANCE	26
SPARK PLUG AND AIR FILTER INSPECTION, OIL REPLACEMENT.....	26
FIRE ARRESTOR ELEMENT.....	28
FUEL TANK FILTER.....	30
MAINTENANCE CHART.....	32
TROUBLE SHOOTING.....	33
STORAGE	35
DRAIN THE FUEL.....	35
MOBILE BATTERY.....	36
GENERATOR.....	36
IDENTIFICATION	36
WIRE DIAGRAM	37
SPECIFICATION	39
REMARK	40

WARRANTY

If any question, please consult designated dealer. It is extremely important to the usage and maintenance of the generator, as unauthorized, unplanned or incorrect repair may cause the warranty invalid.

Keep in mind that designated dealer has special tools, technology, and spare parts necessary for proper repair of generator. Always consult designated dealer if any question about specification, parameter and maintenance of the generator. Occasionally printing error or manufacturing change will possibly make certain portion of this manual incorrect. Until you are fully familiar with this generator, please consult designated dealer before any maintenance.

IMPORTANT LABEL LOCATION

Please read following labels carefully before operating the generator.

NOTE:

Keep or replace safety and instruction labels, if necessary.

SAFETY AND INSTRUCTION LABELS

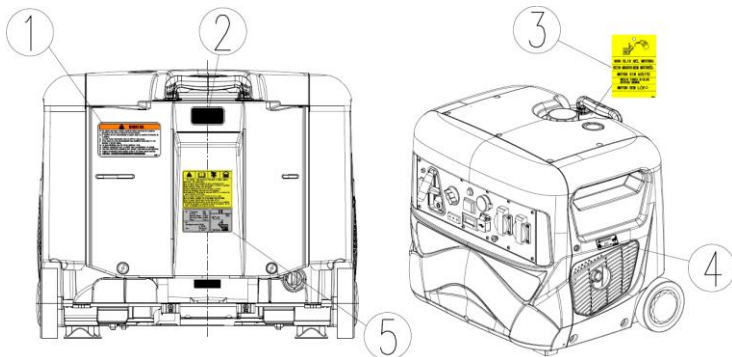

① WARNING LABEL

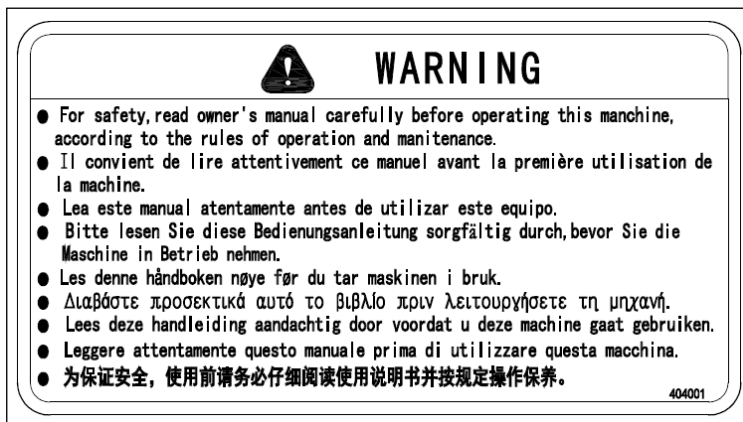

② SPARK PLUG LABEL

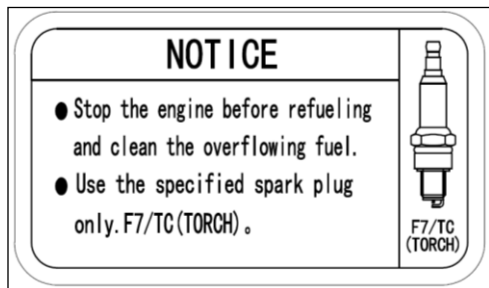

③ NO ENGINE OIL TAG



④ HOT SURFACE WARNING LABEL



⑤ SPECIFICATION LABEL (230V)



For safety, read carefully the owner's manual before operating this equipment:

- Do not operate this equipment in poorly ventilated areas.
- Do not direct exhaust fumes toward people, buildings or equipment.
- When refueling, always stop the engine.
- Always immediately wipe up the fuel that is spilled.
- Keep any flammable items away from this equipment.
- Use gasoline of 92# octane or above and refill oil as required to ensure equipment performance.
- Do not expose the equipment directly to rain or snow.
- Do not touch or contact the wiring sockets with wet hands.
- Do not connect the AC output to any indoor wiring;
- When operating the equipment, do not put any barrier or obstacle around the equipment, or anything on top of the equipment. Do not cover the equipment with a box or the like.

AC	Frequency	50Hz
	Voltage	230V
	Running Power	3.7kVA
	Starting Power	4.5kVA
	Phase	Single

DC	
Voltage/Current:	12V/8A or 5V/2A
Fuel	92# Octane or above

CE

OIL



SAE15W-40

MADE IN CHINA

SYMBOL MEANING

Please understand the symbol meaning before operation as follows.

(Refer to SAFETY INFORMATION for more details.)

The Safety alarm symbol means:

Attention! Be alarm! Your safety involved!

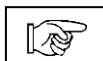

Read this manual before operation.

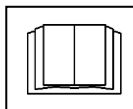
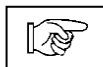

Take care of poisonous exhaust.

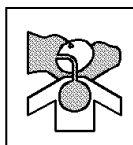

Never operate the generator in a closed area.



Never touch hot surface, such as engine and muffler.



Ground terminal

Make sure the generator grounded.

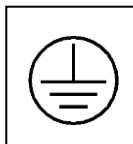

SAFETY INFORMATION

- Never operate the generator in a closed area.
For example, never use it in a closed vehicle or marine.

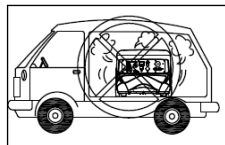

- Never modify or use the generator, when component is removed.

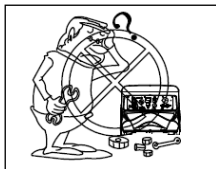

- Never allow children to operate the generator.



- Make sure to move the generator by carrying its telescope handle or handlebar.

- ① Telescope handle
- ② Handlebar

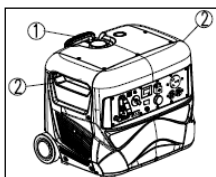

- Never place any obstacle on the generator when running or just shutting down.



POISONOUS EXHAUST

- Never operate the generator in a closed area, or it may cause unconsciousness or death in a short time. Operate the generator in a well-ventilated area.

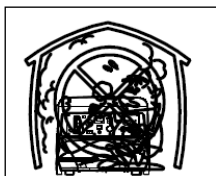

HIGHLY FLAMMABLE AND POISONOUS FUEL

- Shut down the generator when refueling.
- Never refuel when smoking or near an open fire;

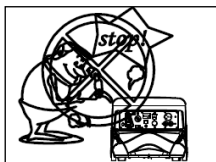

- Take care not to spill any fuel on the generator or muffler when refueling;
- If you carelessly swallow any fuel, inhale fuel vapor, or spill any fuel into eyes, please go to hospital immediately. If you spill any fuel on skin or clothes, please wash it with soap and clean water immediately, and change clothes.

NO TILT DURING OPERATION OR MOVING

When use or move generator, please keep it vertically and upright. If it tilts, it will cause following problems:

- ① Fuel may leaks from carburetor or fuel tank. Meanwhile, during transportation, make sure the fuel tank cap tightened.
- ② Oil overflows, to block air filter element, and cause non-starting of generator. If filter blocked, solve the problem as per chapter of Periodic Maintenance.



HOT GENERATOR AND MUFFLER

- Place the generator in a place where walker or children cannot reach.
- During operation, avoid placing any flammable material near the exhaust outlet.
- Keep the generator at least 1 meter (3 feet) away from building or other equipments, or the generator may be overheated.
- Never operate the generator when covering an anti-dust cover or other stuff.

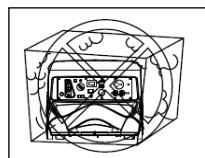
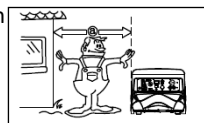
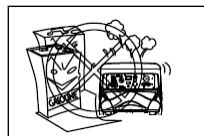
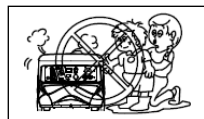

- Make sure the generator and muffler are completely cooled down, when covering the generator.



ELECTRIC SHOCK PREVENTION

- Never operate the generator in rain or snow, or water on the plastic housing, in order to avoid electric shock.



- Never touch the running generator with wet hands, or electric shock will occur.



- Connect generator ground line with ground terminal, and the other end to the ground electrode buried under the ground.

① Ground terminal

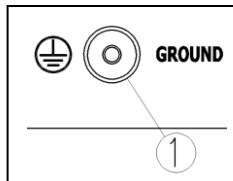

EXTENSION CABLE NOTICE:

- When using not less than 4.0 mm² extension cable, its length should not exceed 60m. Suggest using shorter extension cable as possible.
- The longer the extension cable is, the more voltage reduction between the generator AC socket and connected load will be. Therefore, choose an appropriately long extension cable.
- Please protect the extension cable by a tough and flexible rubber sheath (IEC245) or other equivalent stuff.

CABLE CONNECTION NOTICE:

- Avoid connecting the generator to commercial power socket.
- Avoid parallel connecting the non-parallel-type generator with any other generator. (Connect the parallel-type generator as per instruction).

① Correct ② Incorrect

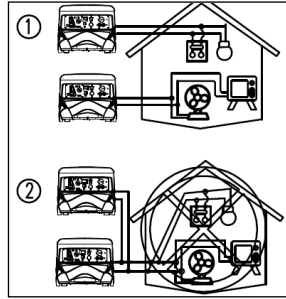
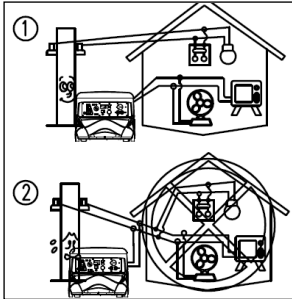

WARNING:

Before connect the generator to a building's electric system, a licensed electrician must install an isolation (transfer) switch in the building's main fuse box. The switch is the connection point for generator power and allows selection of generator power or main line power to the building. This will prevent the generator from charging the main power line (back feeding) when the main power supply has failed or been turned off for a line repair. Back feeding can electrocute or injure line maintenance personnel. Also, generator and building electrical system damage can occur when normal operation power returns if generator is in used without an isolation switch.

DESCRIPTION

DESCRIPTION-45i

- ① Top plastic housing
- ② Air inlet cover
- ③ Handlebar 1
- ④ Battery cover
- ⑤ Wheel
- ⑥ Left plastic housing
- ⑦ Control panel
- ⑧ Recoil starter bar
- ⑨ Choke
- ⑩ Telescope handle
- ⑪ Fuel tank cap
- ⑫ Fuel gauge window
- ⑬ Muffler
- ⑭ Handlebar 2
- ⑮ Muffler exhaust outlet
- ⑯ Bottom plate
- ⑰ Maintenance cover
- ⑱ Air inlet port, air filter

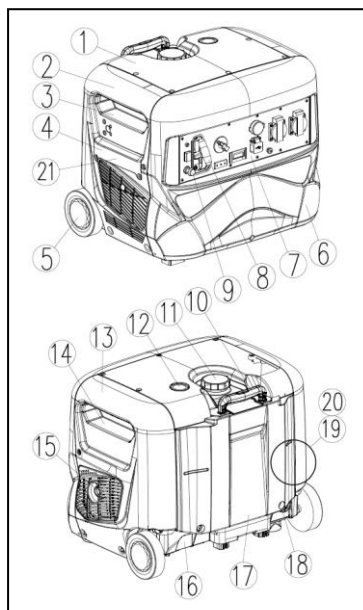

*For 45iE (electric start model), there are two choices of battery systems inside generator,

- ⑲ Lithium battery (standard)
- ⑳ Multi-functional mobile battery (optional)
- 21 Battery cover

22

CONTROL PANEL-45i

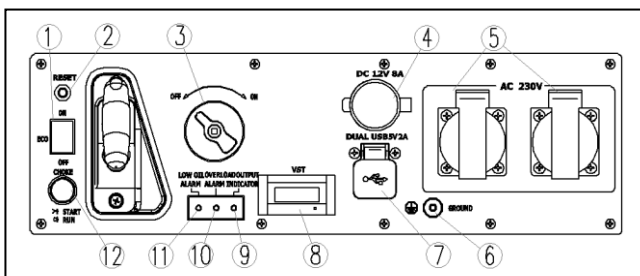

- ① ECO switch
- ② Reset button
- ③ Main switch
- ④ Cig socket
- ⑤ AC socket
- ⑥ Ground terminal
- ⑦ USB outlet
- ⑧ VFT
- ⑨ Output indicator
- ⑩ Overload alarm indicator
- ⑪ Low oil alarm indicator
- ⑫ Choke

CONTROL PANEL-45IE

Base on above 45i model, on the control panel, it removes the choke and related components, and adds engine start button and related components, while other specifications are the same, as follows:

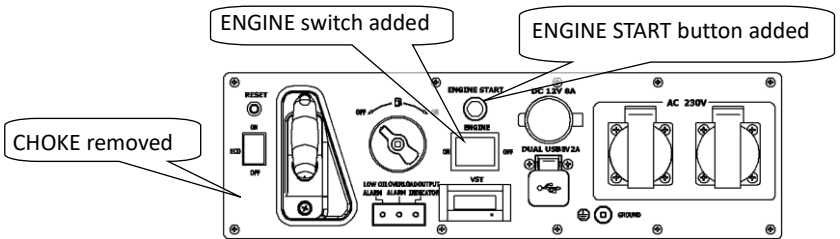

CONRROL FUNCTION

MAIN SWITCH

For 45i model, this switch is both fuel switch and electric switch, while for 45iE model, only fuel switch

- ① OFF: Fuel supply off.

For 45i model, it also shuts the ignition circuit off, and stops the generator.

- ② ON: Fuel supply on.

For 45i model, it also connects the ignition circuit on, and the generator is OK to start.

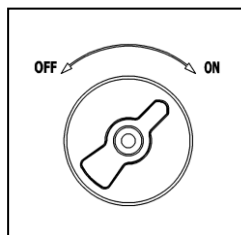

ENGINE SWITCH (45iE ONLY)

- ① OFF: Ignition circuit off;
generator stops.

- ② ON: Ignition circuit on;
generator OK to start;

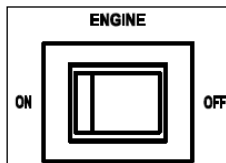

ENGINE START BUTTON (45iE ONLY)

When engine switch and main switch are both ON, press the engine start button

- ① (green), generator starts automatically.

REMOTE CONTROL (45iE ONLY)

When main switch and engine switch are both ON, press the START ① on remote control when it aims at generator, and generator starts automatically; press the STOP ② on remote control, generator is shut to stop running.

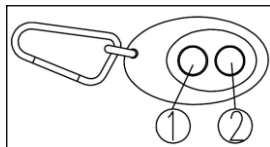

- ① START

- ② STOP

NOTE:

Remote distance may be shorter due to obstacle block or battery power reduction, suggested not exceeding 20 meter.

ECO SWITCH

① ON:

When generator starts,
if no load, it runs at idle speed;
if load connected, it runs at various RPM as
per the load, so as to achieve low fuel
consumption and low noise level.

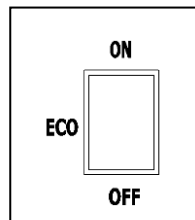

② OFF

Generator starts and runs at rated RPM. It is applicable to high power or low power factor load, which needs high current once connected with generator.

NOTE:

ECO switch must be in position OFF, when applying to electric devices that require a high starting current, such as compressor or submersible pump.

AC SOCKET

According to demand, sockets for other countries are available, including US type, UK type, European type, Australia type...etc.
European type socket (refer to illustration)

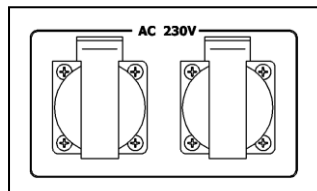

LOW OIL ALARM (YELLOW)

When oil level falls down the Lower level, low oil alarm indicator will be on, and engine will shut automatically. Unless you refill oil, engine will not be started again.

- ① **LOW OIL ALARM**
- ② **OVERLOAD ALARM**
- ③ **OUTPUT INDICATOR**

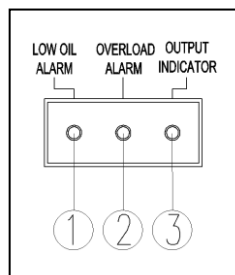

NOTE

If generator cannot start, please turn the main switch to ON position, and then pull the recoil starter. If low oil alarm light flickers for a few seconds, it means oil is insufficient. Place the generator horizontally, add oil (Refer to Periodic Maintenance) and restart.

OVERLOAD ALARM (RED) AND RESET BUTTON (RED)

When the total power of connected electrical devices is detected to close to rated power, the overload alarm indicator (RED) ② will be ON and blinks.

When the total power of connected electrical devices is detected to overload, the overload alarm indicator (RED) ② will be always ON (Red).

The electrical breaker will activate to stop the power generation in order to protect the generator and connected electric devices. The output indicator (Green) will be off, and the overload alarm indicator (red) will stay on, but the generator will not stop running.

When generator stops output due to overload, disconnect all electric devices, reduce total power of connected electric devices to the range of rated power, and press the reset button (Red) ④, generator will recover the output.

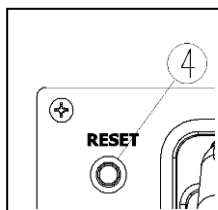

NOTE:

Generator recover output automatically when generator stopped and then restarted.

Overload indicator may flicks for seconds at initial time, when using electric devices that require a high starting current, such as compressor or submersible pump. It is not a fault.

OUTPUT INDICATOR (GREEN)

When generator starts and runs to output power, the output indicator③ is ON.

PRE-OPERATION CHECK

NOTE: Do pre-operation check before using generator each time.

FUEL



WARNING:

- Fuel for the generator is highly flammable and poisonous. Check SAFETY INFORMATION carefully before refueling.
- Do not refuel over the fuel filter or it may overflow when the fuel heats up later and expands.
- Make sure to place the generator horizontally, and tighten the fuel tank cap after refueling.

NOTICE:

- Use clean and dry soft cotton cloth to wipe any spilled fuel, to avoid corrosion on part surface or plastic part.
- Use unleaded fuel to avoid serious corrosion on inner components.

Turn off the fuel tank cap-Illustration A, add fuel till Lower red mark of fuel filter, and then turn the fuel Tank cap on until hearing clicking sound, which means the fuel tank cap tightened.

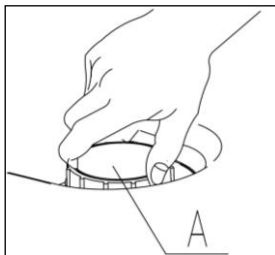

Recommended fuel:

Unleaded gasoline : #92 or above;

Fuel tank capacity: 7.0L (1.8 US gal, or 1.5 Imp gal)

- ① Red mark in fuel filter
- ② Fuel level

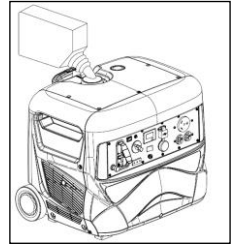
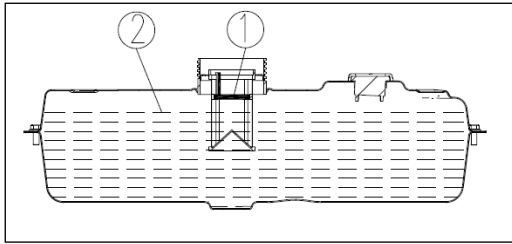

WARNING:

Engine and muffler will become very hot after the engine runs. Avoid touching engine and muffler with any part of your body or clothing while they are not cooled down, during inspection or repair.

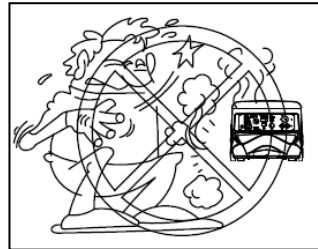

OIL

NOTICE:

- The generator leaves factory without oil. Generator will be protected for non-start without sufficient oil.
- Do not tilt the generator when filling oil, which may result in overfilling and damage to the generator.

For new unit or changing oil, place the generator horizontally, remove the maintenance cover (refer to Periodic Maintenance), take out oil plug, fill 600ml specific oil with special oil filling tool till oil level reaches oil port lower level. When refilling oil, oil level should be at the same level of oil port lower level. Assemble the oil plug and maintenance cover in reverse procedures.

- ① Oil port lower level
- ② Oil port

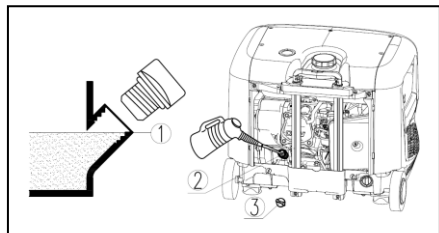

③ Oil plug

Recommended oil: A: SAE15W-40; B: SAE10W-30; C: SAE5W-30

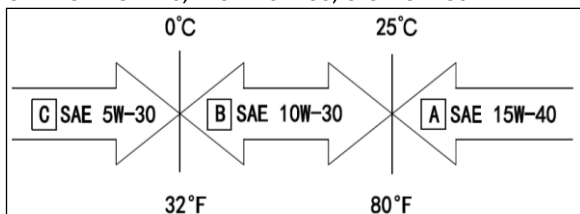

Oil capacity: 0.6L (0.63US qt, 0.53Imp qt)

GROUND TERMINAL

Make sure ground (earth) terminal of generator connected to avoid electric shock. When electric device is applied, generator should connect with earth ground.

① Ground (earth) terminal

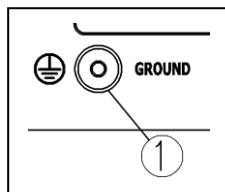

BATTERY (45iE ONLY)

There are two choices of battery for this generator:

- 1) Lithium battery (standard) just for electric starting use;
- 2) Multi-functional mobile battery (optional), not just for electric starting use, but also used as power pack for cell phone, laptop, PSP, MP3/MP4...etc, with lighting function, as well as jump starter for car's emergency starting (remove battery within 20 seconds after car starting).

NOTE:

Output cable and charging cable are not connected with mobile battery from manufacturer for package. Please connect the connecting cable and charging cable as per below instruction during initial use.

Lithium battery

Take out connecting cable and charging cable.

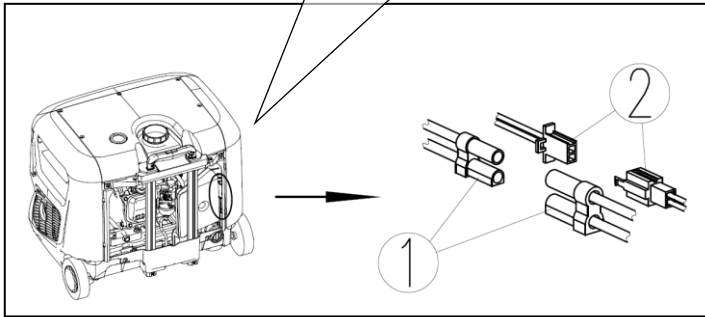

① Connecting cable

② Charging cable

Mobile battery

- ① Two screws
- ② Battery cover
- ③ Mobile battery
- ④ Connecting cable
- ⑤ Charging cable

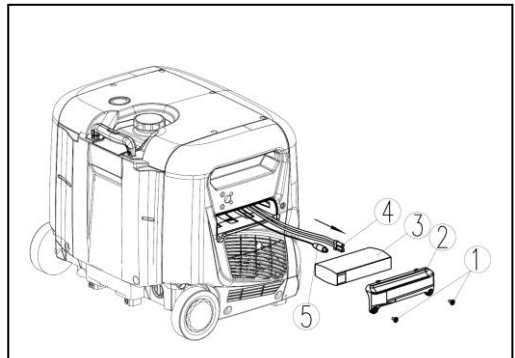

OPERATION

START THE GENERATOR



WARNING:

- Never operate the generator in a closed area or it may cause unconsciousness or death within a short time. Operate the generator in a well-ventilated area.
- Before starting the engine, do not connect any electric device.
- Clean dust, dirt or water off the socket before use.

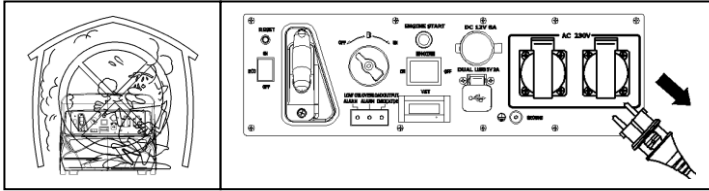

NOTICE:

Read PRE-OPERATION CHECK carefully before operating the generator.

NOTE:

- Generator can run at rated power in standard atmospheric conditions as follows:
 - Ambient temperature: 25 °C
 - Atmospheric pressure: 1000KPa
 - Relative humidity 30%
- Power output will differ due to change in temperature, altitude (the higher altitude, the lower air pressure) and humidity. Power output will reduce, once temperature, humidity and altitude are higher than standard atmospheric condition.
- In addition, please reduce the load in an overheating area, as generator cooling will be affected.

START THE GENERATOR 45i

1. Turn the main switch to position ON.

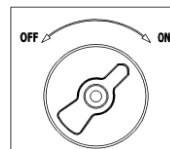

2. Pull out choke completely ①.

① Choke

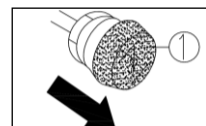

NOTE:

Not to pull out choke to start a warm generator, and please push the choke back to original position.

4. Pull slowly on the recoil starter handlebar until it is tightened, and then pull it fast and hard.

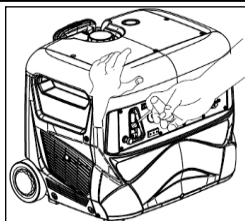

NOTE:

Hold the top of generator firmly to pull it hard better and to prevent it from falling over when pulling the recoil starter.

3. After starting generator, warm it up until pulling back the choke to original position and generator will not shut down.

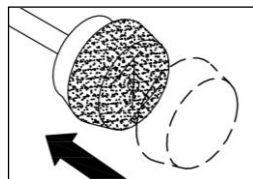

NOTICE:

Pull back choke when generator runs normally, otherwise it will not work well.

START THE GENERATOR 45iE

45iE generator has three types of starting, including recoil start, electric start, and remote start.

Recoil start:

Press the ENGINE switch to position ON, and refer to START THE GENERATOR 45i, but no need to operate choke (auto choke).

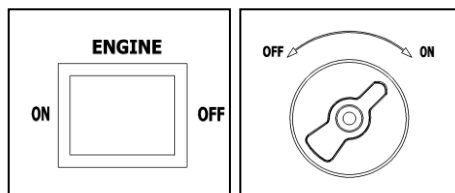

Remote start:

When ENGINE switch and main switch are in position ON, remote control can start the generator by pressing the START button.

① START button

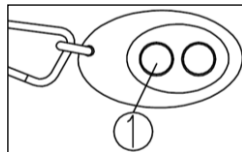

Electric start:

1. Turn the ENGINE switch to position ON.
2. Turn the main switch to position ON.
3. Press the ENGINE START button (green) ① to start the generator

① ENGINE START

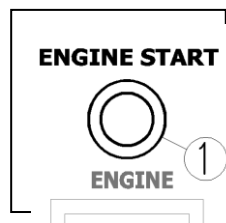





NOTE (FOR STARTING GENERATOR):

- Remote distance may be shorter due to obstacle block or battery power reduction, suggested not exceeding 20 meter.
- During electric start or remote start, just press the ENGINE START on generator or START on remote control one time, the generator will start automatically, no need to hold the button long time.
- When starting the generator, place ECO switch in position OFF, and no load connected with the generator.
- In ambient temperature below 3°C (37°F) , generator should run at idle speed for 5 minutes to warm up.
- In ambient temperature above 3°C (37°F) , generator should run at idle speed for 3 minutes to warm up.
- After warm-up, place ECO switch in position ON, and run the generator in economy status.

APPLICATION RANGE

When operating generator, make sure total load is under the range of generator rated output, or the generator will be damaged.

A AC 			D DC 
B Power factor 1	0.8–0.95	C 0.4–0.75 (Efficiency 0.85)	
45i/45iE	3700VA	2960VA	E Rated voltage 12V Rated current 8A

NOTE:

The overload alarm indicator ① is on (red) when total load exceeds the application range. (Refer to CONTROL FUNCTION).

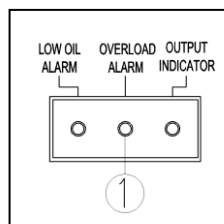

NOTICE:

- Make sure the total load is under the range of generator rated output otherwise generator damage will occur.
- The simultaneous usage of AC and DC power is OK, but total load should not exceed the rated output, otherwise generator will in auto-protection status, or damage will occur.
- Do not overload. The total load of all electrical devices must not exceed the range of the generator rated power. Overloading will damage the generator.
- When powering precision equipment, electronic controllers, PCs, electronic

computers, microcomputer-based equipment or battery chargers, keep the generator a sufficient distance away to prevent electrical interference from the generator. Also, ensure that electrical noise from the generator will not interface with any other electrical devices located near the generator.

- If the generator is to power medical equipment, consult the manufacturer, a medical professional or hospital firstly.
- Some electrical appliances or general-purpose electric motors have high starting current, and cannot be used, even if their watts are within the range in the above table. Consult the equipment manufacturer for further advice.

AC CONNECTION



WARNING

Make sure all electric devices are off before connection.

NOTICE:

- Be sure all electric devices including lines and plugs connections are in good condition before connecting to generator.
- Be sure the total load is within generator rated power.
- Be sure the socket load current is within socket rated current.
- Make sure generator connected to ground earth.

1. Start the generator.
2. Connect the plug with the AC socket.

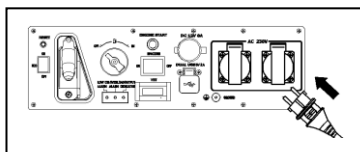

3. Make sure the output indicator is ON (Green) ①.

① Output indicator

4. Turn the ECO switch to the position ON, and then turn on all electric devices.

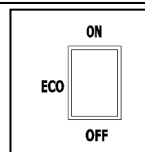
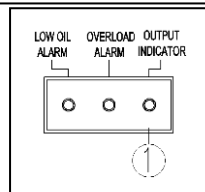

NOTICE:

When using electric devices that require a high starting current, such as compressor or submersible pump, or high-power DC equipment, the ECO switch must be placed in position OFF.

DC CONNECTION

1. USB port (Dual)
DC output: 5V/2A
Applicable to device or battery charge in this range of voltage and power.
2. Cig socket
DC output: 12V/8A
Applicable to device or battery charge in this range of voltage and power.

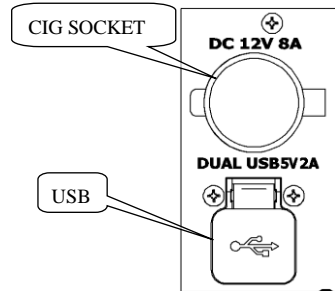

STOPPING THE GENERATOR

1. Disconnect all electric devices, and place ECO switch in position OFF.

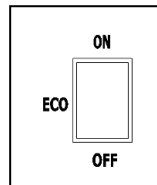
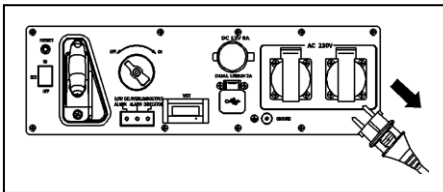

For 45i model, turn the main switch to position OFF, now the fuel supply and ignition circuit off.

For 45iE model,
if short time stopping, press the ENGINE button to position OFF, or press the STOP

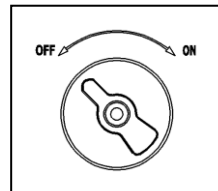

button on remote control;

If long time storage, turn the main switch to position OFF, in order to run up the fuel inside carburetor until engine shuts automatically.

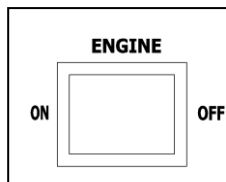

PERIODIC MAINTENANCE

User must pay attention on product safety. Periodic inspection, adjustment and lubrication will keep generator in safest and most efficient condition. The key content will be as follows.



WARNING:

If you are not familiar with maintenance work, please consult designated dealer.

NOTICE:

Use only specified genuine parts for replacement. Consult an authorized dealer for further information.

SPARK PLUG AND AIR FILTER INSPECTION, OIL REPLACEMENT

Remove maintenance cover firstly, then inspect spark plug and air filter, and change oil. After inspection and maintenance of related items, assemble the maintenance cover.

MAINTENANCE COVER REMOVAL AND ASSEMBLY

1. Remove maintenance cover:

Loosen screws ①, pull up maintenance cover ②, loosen connectors A, B, C and D on generator, push out the cover in parallel, and turn back the cover to place it well.

2. Do inspection and maintenance on related items (Refer to below related info).

3. Assemble maintenance cover as per reverse procedure of above removal.

Especially 2pcs connector A and 4pcs connector B should align at connector hole C and D firstly, pull it down, and then tighten 2pcs screws.

- ① Screws (2pcs)
- ② Maintenance cover
- ③ Exhaust cover
- ④ Top plastic housing
- ⑤ Air inlet cover

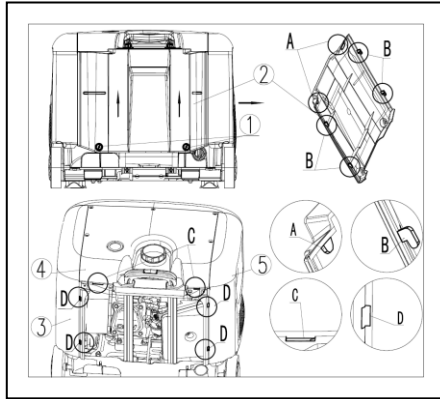

In above illustration,

Connector A (2pcs) on maintenance cover to match connector hole C (2pcs) on top plastic housing ④;

Connector B (4pcs) on maintenance cover to match connector hole D (4pcs) with 2pcs on air inlet cover ⑤ and 2pcs on exhaust cover ③.

NOTE:

Please remove maintenance cover under appropriate force, in order not to damage connectors and holes.

SPARK PLUG INSPECTION

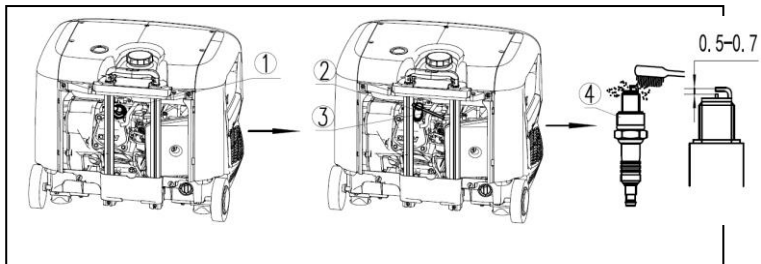

- ① Spark plug cap
- ② Spark socket
- ③ Two-way Screwdriver
- ④ Spark plug

1. Remove spark plug cap①, locate spark plug socket② on spark plug④, turn it counterclockwise with screwdriver ③, and then disassemble spark plug.

2. Check for discoloration and remove the carbon.

Standard electrode color: Medium-to-light tan color.

3. Check spark plug type and clearance.

Standard spark plug: F7TC (TORCH)

Spark plug clearance: 0.5-0.7mm

4. Install and tighten spark plug.

NOTE:

When installing spark plug, twist it by hand, and then tighten it by screwdriver.

5. Assemble spark plug cap, and maintenance cover as per procedure.

AIR FILTER INSPECTION

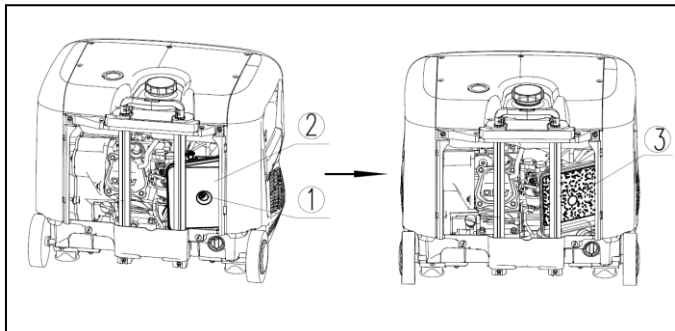

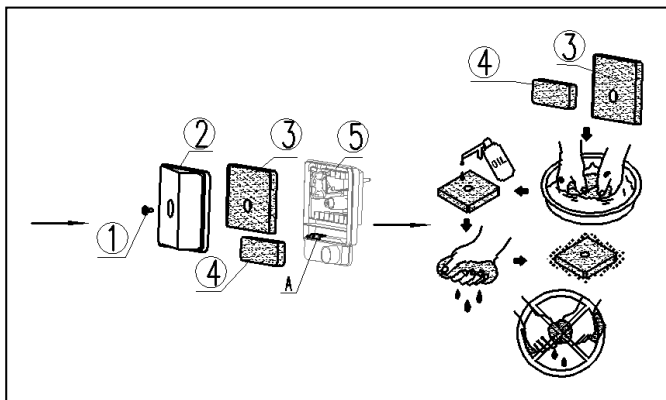

- ① Screw
- ② Air filter cover
- ③ Fine element, Air filter
- ④ Coarse element, Air filter
- ⑤ Air filter body
- A—Coarse element location

1. Loosen screw ①, remove air filter cover ②, take out air filter fine element ③, and take out air filter coarse element ④ from location (A) of air filter body ⑤.
2. Clean fine element and coarse element with solvent, and dry them.
Apply appropriate special oil of 4-stroke engine on element, rub it by hands to make it even, and squeeze out the excessive oil.

NOTICE:

Do not wring out the element sponge, if not it will be damaged.

3. Insert air filter coarse element to location (A) evenly. Then place fine element to air filter body evenly.
4. Assemble air filter cover, and tighten it with screws.
5. Assemble maintenance cover, and tighten the screw.

NOTE:

Never run the generator without element or it may cause excessive poisonous gas and cylinder wears.

OIL REPLACEMENT



WARNING:

Never drain oil immediately shut the generator to avoid scald.

1. Place generator horizontally, and start generator for several minutes to reduce the oil viscosity. Then shut the generator. Remove maintenance cover as above.

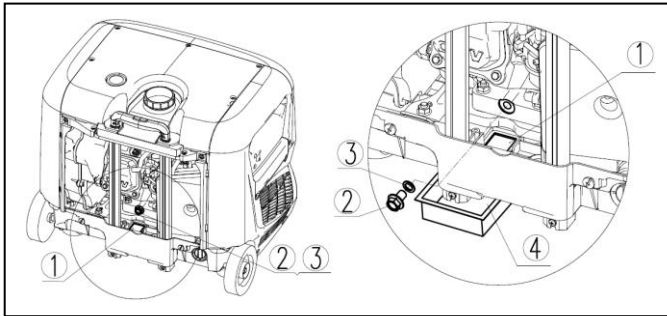

- ① Rubber gasket
- ② Oil drain screw
- ③ Aluminum gasket
- ④ Oil container

2. Remove rubber gasket of oil drain hole ① from bottom plate (pull up from bottom plate), place an oil container ④ bigger than 1L below generator, remove oil drain screw ② and aluminum gasket ③, then tilt the generator to drain all oil. (If possible, more convenient to use negative pump to drain the oil from engine crankcase)

NOTE:

Replace aluminum gasket once removed.

3. Take oil container away, put new aluminum gasket on oil drain screw and insert it into oil drain port, screw it by hand, and tight it by tool, and then assemble rubber gasket on oil drain port.

4. Place generator horizontally, and fill oil till oil port Lower level. Refer to OIL FILLING AND CHANGE.

⑤ Oil port lower level

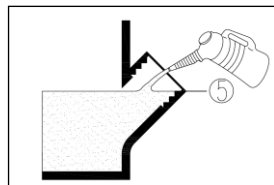

NOTICE:

Do not tilt the generator when filling oil. This would result in overfilling and damage to the engine.

Be sure no other material enters the engine crankcase.

Should send the replaced waste oil to professional disposal point.

5. Wipe any spilled oil around oil port, and tighten oil plug to oil port.

6. Assemble maintenance cover.

FIRE ARRESTER ELEMENT

When abnormal noise happens from engine, or output power is reduced, it may be caused by block of fire arrester. Please check the fire arrester.

Before check, please refer to WARNING for more safety info.

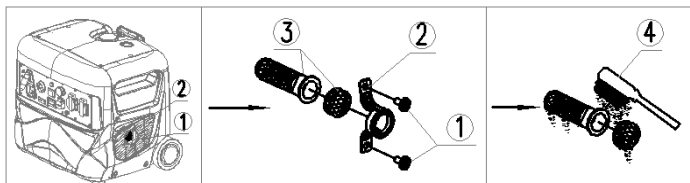

① Screw (2pcs)

② Ring flange

③ Element, fire arrester

④ Steel brush

1. Loosen screws ① on both sides of the exhaust outlet, and remove the ring flange ② and the fire arrester element ③.

2. Remove the fire arrester element, and clean the carbon deposit with the steel brush ④.

WARNING:

Use the steel brush lightly to avoid damaging or scratching fire arrestor element during cleaning.

3. Check the fire arrestor element. Replace it if damaged.
4. Assemble fire arrestor element on muffler, and then ring flange, tighten the screws on both side.

FUEL TANK FILTER

1. Turn out fuel tank cap, and take out fuel filter from fuel port.
2. Apply gasoline to clean fuel filter. Check the filter screen. Replace it if damaged.

NOTE:

Please deliver the used gasoline to special disposal point after cleaning.

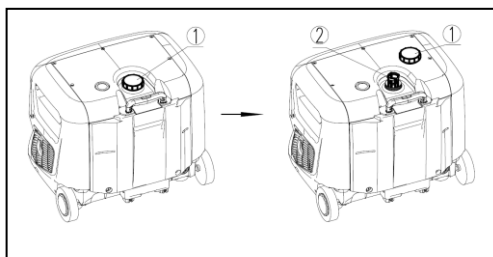

① Fuel tank cap

② Fuel filter

3. Wipe the filter ② clean, and assemble it into fuel tank port.
4. Turn on fuel tank cap ① till clicking sound, which means the fuel tank cap is tightened.

**WARNING:**

Make sure to tighten the fuel tank cap to avoid fuel flow out to cause danger.

MAINTENANCE CHART**WARNING:**

Stop the generator before starting maintenance work.

Item	Normal check	Pre-operation check	Every 6 months or 100 hour	Every 12 months or 300 hour
Spark plug	Check, clean and replace it if necessary		○	
Fuel	Check fuel level, and leakage	○		
Fuel hose	Check fuel hose for cracks or damage. Replace if necessary.			○
Oil	Check oil level for leakage		○	
	Replace		○(1)	
Air filter	Check, Clean		○(2)	
Fire arrester element	Check, clean and replace it if necessary		○	
Waste air cycling hose	Check for crack or damage. Replace it if necessary.			○
Cylinder head	Decarbonizes combustion chamber, inlet valve, and exhaust valve of cylinder head. More frequently if necessary			★
Valve clearance	Check and adjust it when generator cooled down.			★
Fitting, fastener	Check all fittings and fasteners for looseness. Replace it if necessary.			★
Verify abnormal point and correct it when using.		○		

Note:

- 1) Do initial oil replacement within one month or after 20 hours running.
- 2) Air filter needs to clean more frequently when using in unusually wet or dusty areas.

★ since these items require special tools, data and technical skills, please have

designated dealer do it.

TROUBLESHOOTING

Generator not start or Generator no output

1. Check opening of following switches, and open it if closed:

- ENGINE switch ON
- Main switch ON
- Choke pull out, and pull in after running
- Refer to OPERATION: ENGINE START

2. Check LOW OIL ALARM (Yellow) flash

- If the indicator flashes, oil is insufficient.

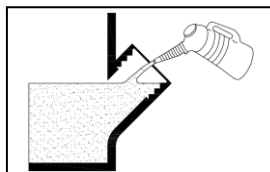

Fill the oil, and restart. Refer to CONTROL

FUNCTION: Low oil alarm and PRE-OPERATION CHECK: Oil.

3. Generator tilts to cause air filter blocked.

Generator tilt to cause oil flow out, and block the air filter element, which leads to non-start. Must dry excessive oil, and clean the air filter element, refer to PERIODIC MAINTENANCE.

4. Insufficient fuel

- Check fuel gauge window on top of generator. If red mark on side of E (as illustration), it means insufficient fuel. Must fill fuel.

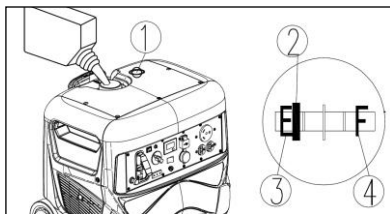

① Fuel gauge window

② Red fuel level mark

③ E—Empty

④ F—Full

5. Fuel supply blocked

- Carburetor blocked

Remaining fuel inside carburetor after long time will block carburetor.

Solution: Turn on fuel switch (Place fuel switch to position ON), loose carburetor fuel drain screw, and let fuel flow out to keep cleaning carburetor for 10-20s.

-
- If no fuel flows out after loosening fuel drain screw in above operation, it means fuel supply blocked, please consult designated dealers.
6. Air flow blocked
- Air filter coarse and fine element blocked. Refer to PERIODIC MAINTENANCE: Air filter.
 - Fire arrestor blocked. Refer to PERIODIC MAINTENANCE: Fire arrestor.
7. Poor spark

Spark plug is dirty with carbon or wet:

- Remove carbon or wipe and dry spark plug.
 - Check spark plug clearance 0.5~0.7mm:
Replace it if there is over tolerance.
 - Faulty ignition system: Consult the local dealer.
8. Overload, and generator no output
- Refer to CONTROL FUNCTION: Overload alarm indicator (Red) and Reset (Red).

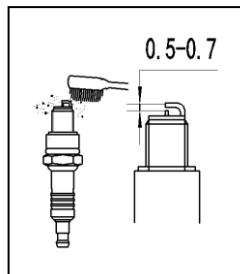

STORAGE

Generator will require some preventive procedures for long term storage, and be kept in venting area.

DRAIN THE FUEL

Two ways as follows (choose one as per demand):

First way (For 45iE only):

1. Start the generator. Refer to OPERATION: START THE GENERATOR.
2. Turn the main switch to position OFF.
3. Generator will shut down automatically after running up all remaining fuel inside carburetor.
4. Turn off ENGINE switch to position OFF.
5. Remove fuel tank cap, drain fuel from fuel tank to approved fuel container by special tool. Install fuel tank cap.

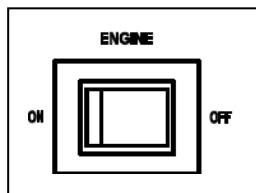

Second Way:

- ① Fuel drain screw
- ② Fuel drain pipe
- ③ Carburetor
- ④ Fuel container

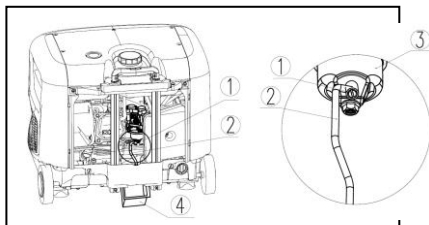

1. Turn main switch to position ON.
2. Remove fuel tank cap, drain the fuel from fuel tank to approved container to approved fuel container by special tool. Install fuel tank cap.
3. Place generator horizontally, and remove maintenance cover. Refer to PERIODIC MAINTENANCE.
4. Drain remaining fuel from carburetor:
Place a clean fuel container④ on bottom of fuel drain pipe②, loose fuel drain screw① of bottom of carburetor③ to drain remaining fuel. And then turn the main switch to position OFF until no more fuel.

NOTICE:

Please use an appropriate fuel container not less than 1L during fuel drain.
The drained fuel should kept in approved fuel container.

5. Tighten fuel drain screw, and assemble maintenance cover.



WARNING:

Fuel used in the generator is highly flammable and poisonous. Check SAFETY INFORMATION carefully before operation. Make sure to wipe up any spilled fuel immediately to avoid damage on rubber or plastic parts.

BATTERY

1. For 45iE model, press the ENGINE switch to position OFF.
2. To keep the generator more than 2-3 months, suggest you charge the battery once every month to extend the battery life.

GENERATOR

In order to protect engine inside cylinder, piston rings and other parts, please proceed as following steps:

1. Turn the ENGINE switch and main switch to position OFF.
2. Remove the spark plug, pour about one spoon SAE10W-30 or 15W-40 oil into the spark plug, and then install the spark plug. Pull the recoil starter for several times to coat the cylinder wall, piston rings and other parts with oil. (You can do this after DRAIN THE FUEL)
3. Pull the recoil starter until you feel compression and then stop pulling (This prevents the cylinder and valves from rusting).
4. Clean the exterior part of the generator.
5. Store the generator in a dry and well-ventilated place, with a clean cloth covered.
6. The generator must remain in a vertical position when stored, carried and operated.

IDENTIFICATION

The machine identification series number is attached in the location as shown in drawing.

- ① Machine series number

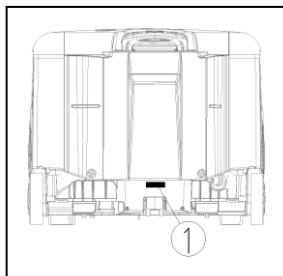

WIRE DIAGRAM

1. 45i wire diagram

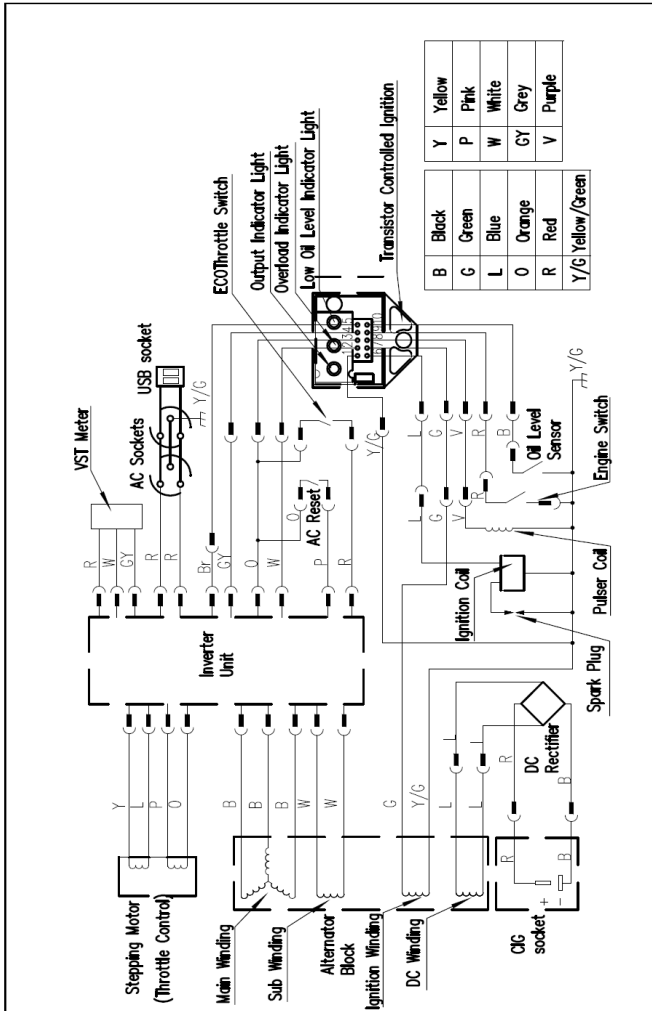

2. 45iE wire diagram

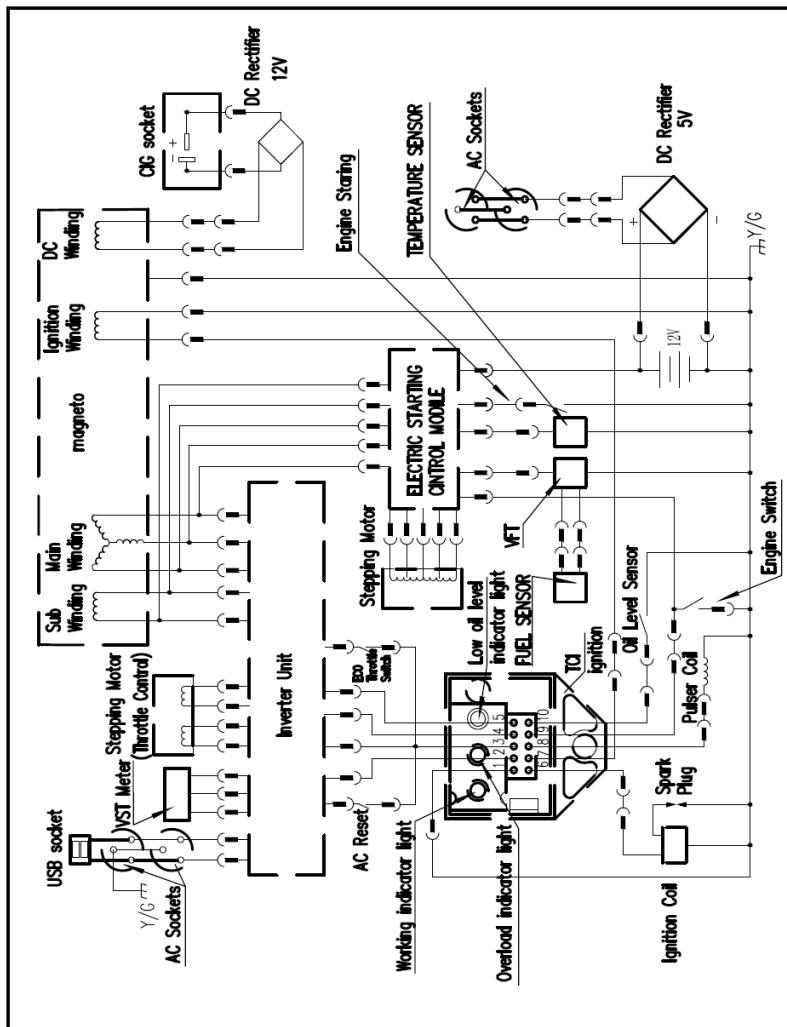

SPECIFICATION

Item	Unit	Model	
		45i	45iE
Starting type		Recoil	Recoil/Electric/Remote
Engine model		LH170F	
Engine type		4 Stroke, OHV gasoline engine	
Displacement	ml	211.5	
Oil	ml	600	
AC rated Voltage and Frequency	V/Hz	230/50 or 120/60	
Running Power	VA	3700	
Starting Power	VA	4500	
Power factor		1.0	
Fuel tank capacity	L	7.0	
Noise level *	dB/LWA	55~60	
DC rated voltage	V	12	
DC rated current	A	8	
Dimension	mm	580x453x481	
N.W.	kg	36.6	37.7

★ Noise level is measured, when the ECO switch is ON.

LWA shows the sound power level under the ISO3744 standard test condition.

The noise level in dB (A)/7M is the arithmetic mean value in four directions measured 7 meters away from each side of the generator.

The noise level may vary in different environments.

★ NOISE LEVEL

The figures quoted are emission levels and are not necessarily safe working levels. Whilst there is a correlation between the emission and exposure levels, this cannot be used reliably to determine whether or not further precautions are required. Factors that influence the actual level of exposure of work-force include the characteristics of the work room, the other sources of noise, etc. i.e. the number of machines and other adjacent processes, and the length of time for which an operator is exposed to the noise. Also the permissible exposure level can vary from country. This information, however, will enable the use of the machine to make a better evaluation of the hazard and risk.

REMARK



WARNING

- For safety, read owner's manual carefully before operating this machine, according to the rules of operation and maintenance.
- Il convient de lire attentivement ce manuel avant la première utilisation de la machine.
- Lea este manual atentamente antes de utilizar este equipo.
- Bitte lesen Sie diese Bedienungsanleitung sorgfältig durch, bevor Sie die Maschine in Betrieb nehmen.
- Les denne håndboken nøye før du tar maskinen i bruk.
- Διαβάστε προσεκτικά αυτό το βιβλίο πριν λειτουργήσετε τη μηχανή.
- Lees deze handleiding aandachtig door voordat u deze machine gaat gebruiken.
- Leggere attentamente questo manuale prima di utilizzare questa macchina.
- 为保证安全，使用前请务必仔细阅读使用说明书并按规定操作保养。

400002